



# CC-Link Intelligent Device Driver

1	System Configuration.....	4
2	Selection of External Device .....	11
3	Example of Communication Setting.....	12
4	Setup Items.....	25
5	Cable Diagram .....	29
6	Supported Devices.....	31
7	Device Code and Address Code.....	35
8	Error Messages.....	37

## Introduction

This manual describes how to connect the Display and the External Device (target PLC).

In this manual, the connection procedure will be described by following the sections below:

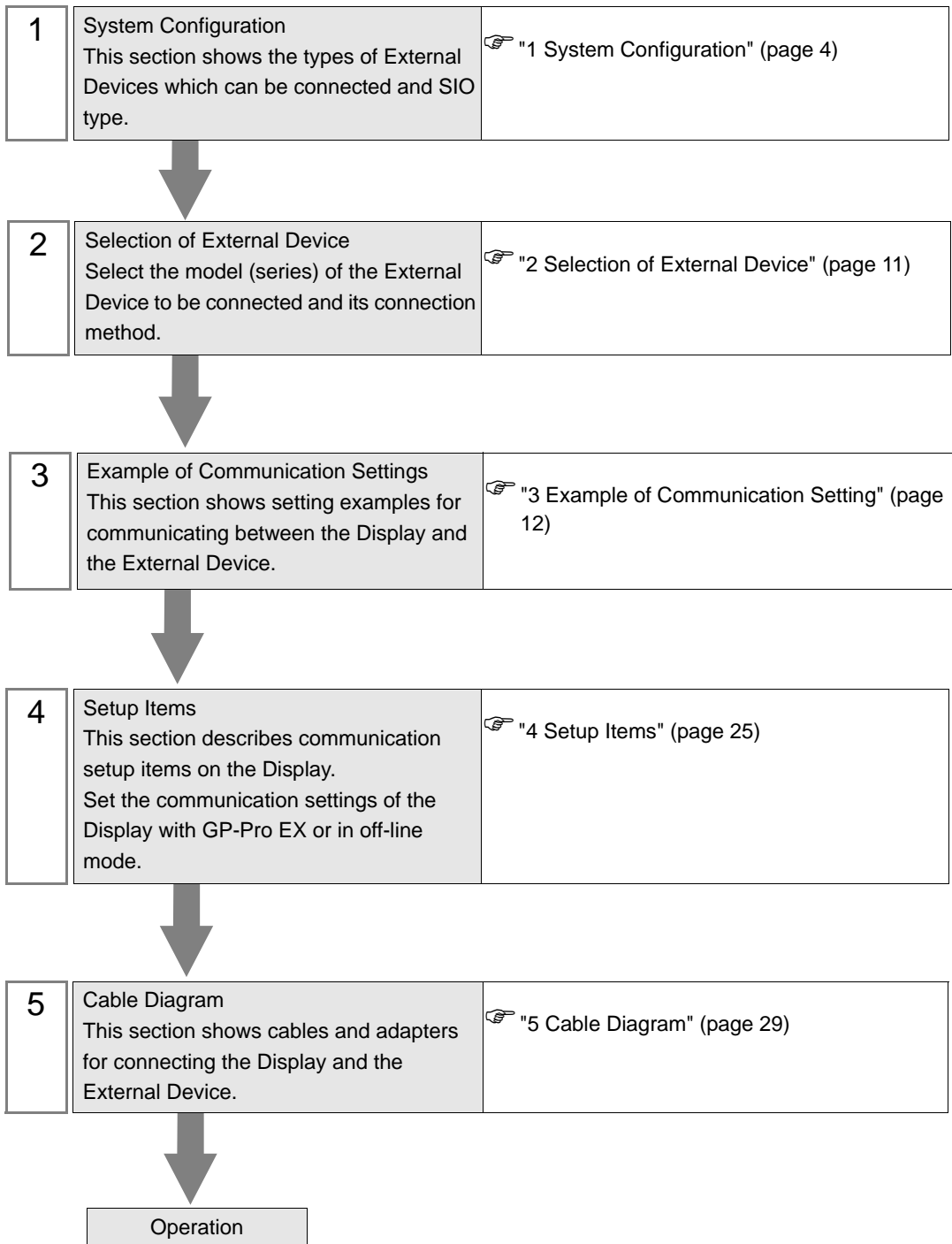

## ■ Terminology

The following table describes the terminology used in the CC-Link.

Term	Definition and Description
Cyclic Transmission	A function that periodically exchanges data across the network connected to the CC-Link.
Extended Cyclic Transmission	A function that periodically exchanges up to 128 pieces of bit data and up to 64 pieces of word data per station using split transfer. Available to CC-Link Ver 2.00 or later.
Extended Cyclic Setting	Used for extending the cyclic points in the extended cyclic transmission. Select 2, 4, or 8 times.
Transient Transmission	A function that exchanges data across the network connected to the CC-Link only when the data is requested.
Master Station	A station that controls the entire network with control information (parameters). Set one station per network. The station No. is "0".
Slave Station	A generic name for stations other than the master station.
Intelligent Device Station	A station that performs the cyclic transmission and the transient transmission for the master station in the ratio of 1:n.
Number of Occupied Stations	The number of stations on the network that one slave station occupies. Select one to four stations depending on the number of data.

# 1 System Configuration

The following shows the system configuration where the External Device from Mitsubishi Electric Corp. and the Display are connected.

Series	CPU	Link I/F	Communication Type	Setting Example	Cable Diagram
MELSEC A Series	A1SCPU A1SHCPU A1SJCPU A1SJCPU-S3 A1SJHCPU A1SCPU24-R2 A2SCPU A2SHCPU A2USCPU A2USCPU-S1 A2USHCPU-S1	A1SJ61BT11	CC-Link Ver.1.1	Setting Example 1 (page 12)	Cable Diagram 1 (page 29)
	A0J2CPU A0J2HCPU A1CPU A2CPU A2CPU-S1 A3CPU A1NCP A2NCP A2NCP-S1 A3NCP A3MCP A3HCP A2ACP A2ACP-S1 A3ACP A2UCP A2UCP-S1 A3UCP A4UCP	AJ61BT11			
MELSEC QnA Series	Q2ASCPU Q2ASCPU-S1 Q2ASHCPU Q2ASHCPU-S1	A1SJ61QBT11	CC-Link Ver.1.1	Setting Example 2 (page 15) *1	Cable Diagram 1 (page 29)
		AJ61QBT11		Setting Example 3 (page 18) *2	
Q2ACPU Q2ACPU-S1 Q3ACPU Q4ACPU Q4ARCPU	AJ61QBT11		CC-Link Ver.1.1	Setting Example 2 (page 15) *1	
		Setting Example 3 (page 18) *2			

Series	CPU	Link I/F	Communication Type	Setting Example	Cable Diagram
MELSEC Q Series	Q00JCPU Q00CPU Q01CPU Q02CPU Q02HCPU Q06HCPU Q12HCPU Q25HCPU Q12PHCPU Q25PHCPU Q12PRHCPU Q25PRHCPU	QJ61BT11N	CC-Link Ver.1.1	Setting Example 4 (page 21)	Cable Diagram 1 (page 29)
	CC-Link Ver.2.0		Setting Example 5 (page 23)		
		QJ61BT11	CC-Link Ver.1.1	Setting Example 4 (page 21)	
	Q02CPU-A Q02HCPU-A Q06HCPU-A	A1SJ61BT11	CC-Link Ver.1.1	Setting Example 1 (page 12)	
	Q02UCPU Q03UDCPU Q04UDHCPU Q06UDHCPU	QJ61BT11N	CC-Link Ver.1.1	Setting Example 4 (page 21)	
			CC-Link Ver.2.0	Setting Example 5 (page 23)	

\*1 Use the ladder program for communication settings. Available to all feature versions of the Link I/F.

\*2 Configure the communication settings in [Network Parameter] in the ladder software (GX-Developer). Available to feature version B or later of the Link I/F. Check the feature version on the nameplate located on the side of the Link I/F unit.

**IMPORTANT**

- To use the CC-Link, you need a CC-Link unit (CA7-CCLALL/EX-01) from Pro-face. For details on the wiring between the Display (CC-Link unit) and the CC-Link master and on the CC-Link unit, refer to "CC-Link Unit Intelligent Device Station Hardware Manual".

## ■ Connection Configuration

When this driver is used, the Displays will operate as intelligent device stations.

### ◆ Network Connection Example

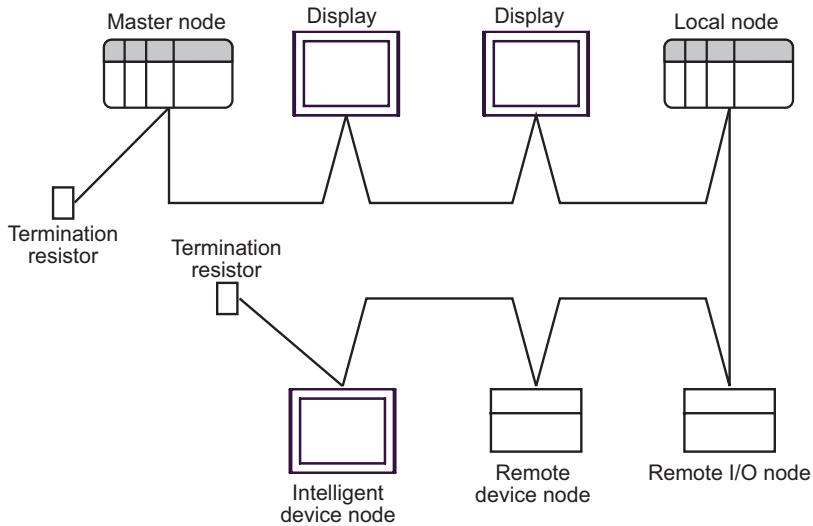

**NOTE** • Make sure to connect termination resistors to both ends of the network.

Cable Type	Termination Resistance
CC-Link dedicated cable	110 1/2W
CC-Link dedicated high-performance cable	130 1/2W

### ◆ Maximum Transmission Distance

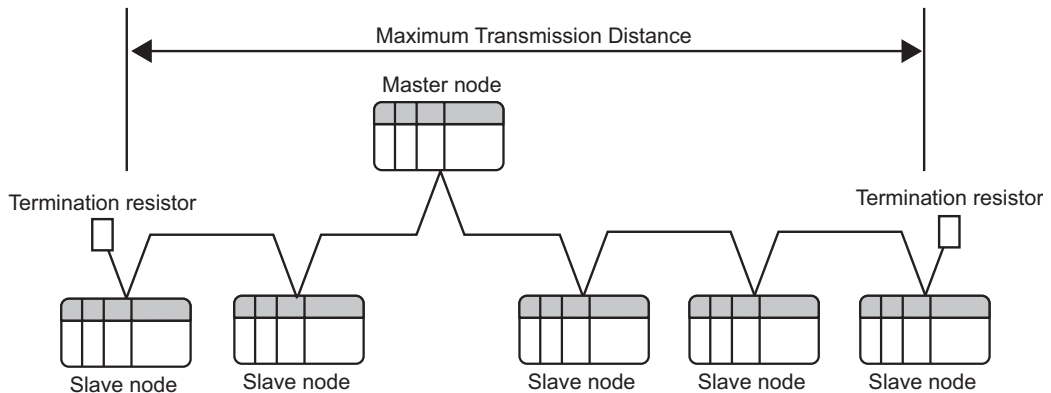

Transmission Speed	156Kbps	625Kbps	2.5Mbps	5Mbps	10Mbps
Cable Length Between Stations	20cm or more				
Maximum Transmission Distance	1200m	900m	400m	160m	100m

◆ Number of Connectable Units

The number of slave stations connected to the master station should meet the following four conditions:

1	$\{(a + a2 + a4 + a8) + (b + b2 + b4 + b8) \times 2 + (c + c2 + c4 + c8) \times 3 + (d + d2 + d4 + d8) \times 4\} \leq 64$	<p>a: Number of units with 1 station occupied and 1 time setting (including Ver.1-compatible station)</p> <p>b: Number of units with 2 stations occupied and 1 time setting (including Ver.1-compatible station)</p> <p>c: Number of units with 3 stations occupied and 1 time setting (including Ver.1-compatible station)</p> <p>d: Number of units with 4 stations occupied and 1 time setting (including Ver.1-compatible station)</p>
2	$\{(a \times 32 + a2 \times 32 + a4 \times 64 + a8 \times 128) + (b \times 64 + b2 \times 96 + b4 \times 192 + b8 \times 384) + (c \times 96 + c2 \times 160 + c4 \times 320 + c8 \times 640) + (d \times 128 + d2 \times 224 + d4 \times 448 + d8 \times 896)\} \leq 8192$	<p>a2: Number of units with 1 station occupied and 2 times setting</p> <p>b2: Number of units with 2 stations occupied and 2 times setting</p> <p>c2: Number of units with 3 stations occupied and 2 times setting</p> <p>d2: Number of units with 4 stations occupied and 2 times setting</p>
3	$\{(a \times 4 + a2 \times 8 + a4 \times 16 + a8 \times 32) + (b \times 8 + b2 \times 16 + b4 \times 32 + b8 \times 64) + (c \times 12 + c2 \times 24 + c4 \times 48 + c8 \times 96) + (d \times 16 + d2 \times 32 + d4 \times 64 + d8 \times 128)\} \leq 2048$	<p>a4: Number of units with 1 station occupied and 4 times setting</p> <p>b4: Number of units with 2 stations occupied and 4 times setting</p> <p>c4: Number of units with 3 stations occupied and 4 times setting</p> <p>d4: Number of units with 4 stations occupied and 4 times setting</p> <p>a8: Number of units with 1 station occupied and 8 times setting</p> <p>b8: Number of units with 2 stations occupied and 8 times setting</p> <p>c8: Number of units with 3 stations occupied and 8 times setting</p> <p>d8: Number of units with 4 stations occupied and 8 times setting</p>
4	$\{(16 \times A) + (54 \times B) + (88 \times C)\} \leq 2304$	<p>A: Number of remote I/O stations <math>\leq 64</math></p> <p>B: Number of remote device stations <math>\leq 42</math></p> <p>C: Number of local stations and intelligent device stations <math>\leq 26</math></p>

The Displays will operate as intelligent device stations. Also, the minimum number of occupied stations is 1. Therefore, the number of Displays that can be connected to a single master station is 26.

**IMPORTANT**

- The transient transmission is processed more slowly than the cyclic transmission. If fast processing is required, use the cyclic transmission.

◆ CC-Link Specifications

The remote I/O (RX, RY) and the remote register (RWw, RWr) can be allocated from the master station.

The data points allocated to each station depend on their extended cyclic setting. For the point difference between extended cyclic settings, refer to the link point table shown later.

- Allocation image of the remote input via the master station

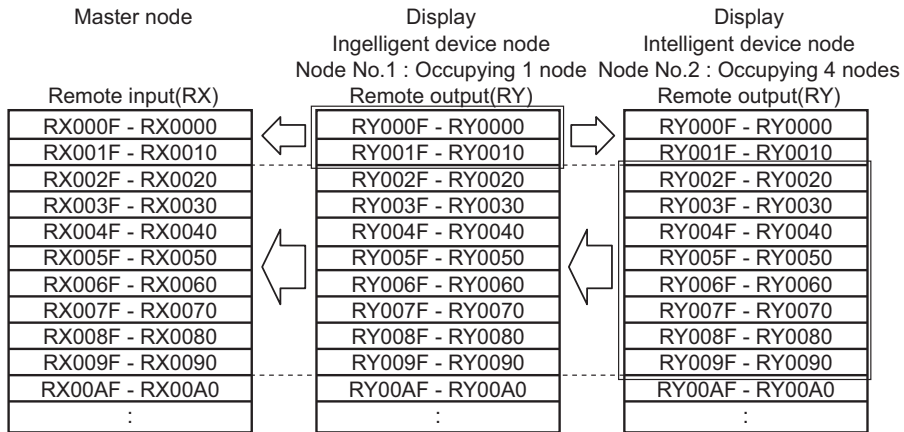

- Allocation image of the remote output via the master station

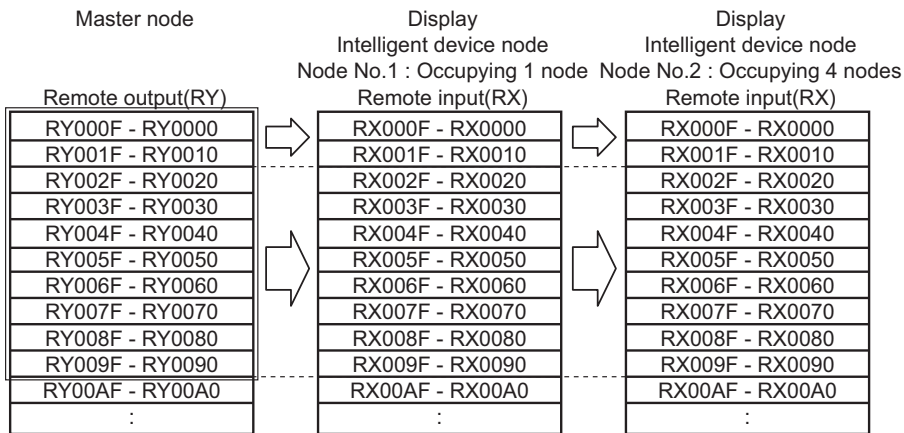

- Allocation image of the remote register (RWr) via the master station

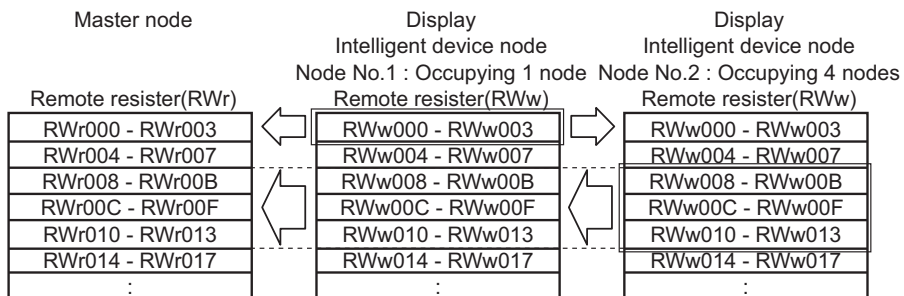

- Allocation image of the remote register (RWw) via the master station

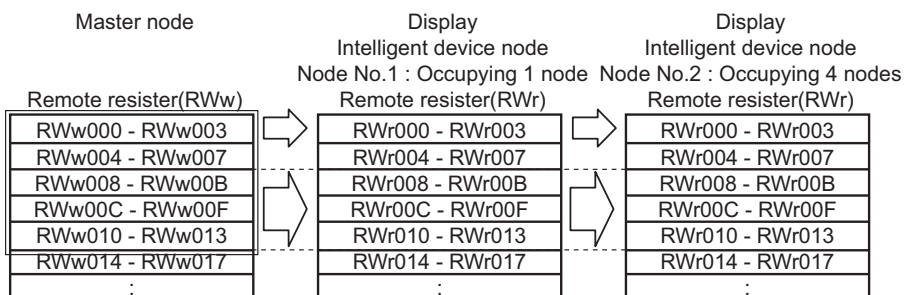



The following shows the link point specifications defined by the CC-Link Association. For CC-Link Ver.1, the extended cyclic setting is not available, and "1 time setting" is applied.

Item		Specification				
Maximum number of link points per system	CC-Link Ver.1	Remote I/O (RX, RY): 2048 points each Remote register (RWw): 256 points Remote register (RWr): 256 points				
	CC-Link Ver.2	Remote I/O (RX, RY): 8192 points each Remote register (RWw): 2048 points Remote register (RWr): 2048 points				
Extended cyclic setting (fixed at one time in CC-Link Ver.1)		1 time setting	2 times setting	4 times setting	8 times setting	
Number of link points per unit	1 station occupied	Remote I/O (RX, RY)	32 points each	32 points each	64 points each	128 points each
		Remote register (RWw)	4 points	8 points	16 points	32 points
		Remote register (RWr)	4 points	8 points	16 points	32 points
	2 stations occupied	Remote I/O (RX, RY)	64 points each	96 points each	192 points each	384 points each
		Remote register (RWw)	8 points	16 points	32 points	64 points
		Remote register (RWr)	8 points	16 points	32 points	64 points
	3 stations occupied	Remote I/O (RX, RY)	96 points each	160 points each	320 points each	640 points each
		Remote register (RWw)	12 points	24 points	48 points	96 points
		Remote register (RWr)	12 points	24 points	48 points	96 points
	4 stations occupied	Remote I/O (RX, RY)	128 points each	224 points each	448 points each	896 points each
		Remote register (RWw)	16 points	32 points	64 points	128 points
		Remote register (RWr)	16 points	32 points	64 points	128 points

◆ Remote I/O Signal

- When the remote READY flag is not used (default)

Signal Direction: Display → Master Station		Signal Direction: Master Station → Display	
Device No.	Signal Name	Device No.	Signal Name
RYn0	User area	RXn0	User area
RYn1		RXn1	
:		:	
RY(m+n)D		RX(m+n)D	
RY(m+n)E	Unavailable *1	RX(m+n)E	Unavailable *1
RY(m+n)F		RX(m+n)F	

\*1 In each station setup, the last two bits cannot be used.

- When the remote READY flag is used

Signal Direction: Display → Master Station		Signal Direction: Master Station → Display	
Device No.	Signal Name	Device No.	Signal Name
RYn0	User area	RXn0	User area
RYn1		RXn1	
:		:	
RY(m+n)0	Unavailable	RX(m+n)0	Unavailable
:			
RY(m+n)A	Remote READY flag <sup>*1</sup>	:	
RY(m+n)B		:	
RY(m+n)C	Unavailable		
:			
RY(m+n)F		RX(m+n)F	

\*1 The remote READY flag will turn ON when the Display is online. When the Display turns ON, when the hardware is reset, and when the Display is ready for operation, the remote READY flag will turn ON. Even while the Display is ON, the remote READY flag will turn OFF during offline operation and initial processing. Use this feature for the interlock circuit used when writing and reading data from the CC-Link master station.

n: The first device number allocated to the master station

m: The last device number that depends on the number of occupied stations and on the extended cyclic setting.

## 2 Selection of External Device

Select the External Device to be connected to the Display.

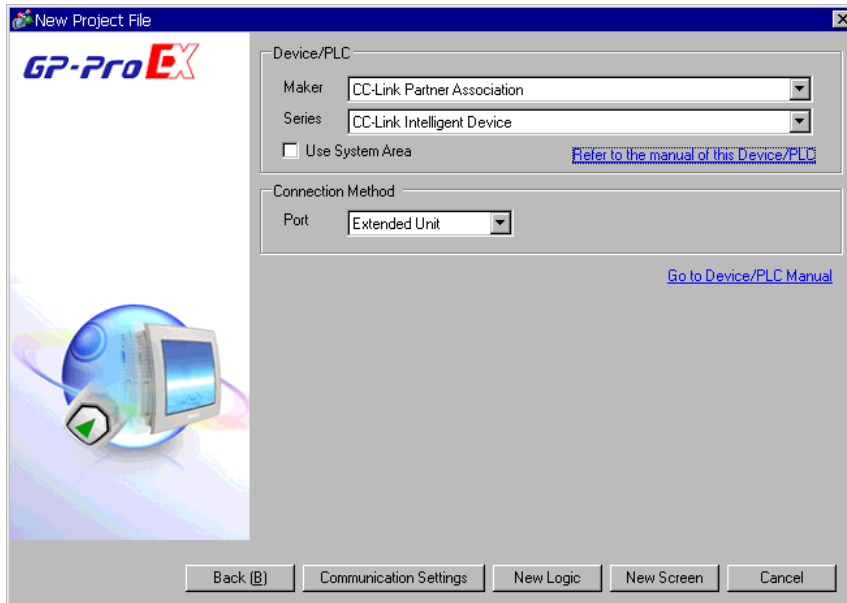

Setup Items	Setup Description
Maker	Select the maker of the External Device to be connected. Select "CC-Link Partner Association".
Series	Select the model (series) of the External Device to be connected and its connection method. Select "CC-Link Intelligent Device". Check the External Device that can be connected in "CC-Link Intelligent Device" in system configuration.  "1 System Configuration" (page 4)
Use System Area	Check this option when you synchronize the system data area of the Display and the device (memory) of the External Device. When they are synchronized, you can use the ladder program of the External Device to switch the display or to display the window on the Display. Cf. GP-Pro EX Reference Manual "Appendix 1.4 LS Area (only for direct access method)"  This can also be set with GP-Pro EX or in off-line mode of the Display. Cf. GP-Pro EX Reference Manual "5.14.6 Setting Guide of [System Setting Window], Setting Guide of [Main Unit Settings], System Area Setting"  Cf. Maintenance/Troubleshooting Manual "2.14.1 Common to the Display", Setting Guide of [Main Unit Settings], System Area Setting"
Port	Select the port of the Display to be connected to the External Device.

### 3 Example of Communication Setting

The following shows examples of communication settings of the Display and the External Device, which are recommended by Pro-face.

#### 3.1 Setting Example 1

##### ■ Settings of GP-Pro EX

##### ◆ Communication Settings

To display the setting screen, select [Device/PLC Settings] from [System setting window] in workspace.

Device/PLC 1

Summary [Change Device/PLC](#)

Maker: CC-Link Partner Association Series: CC-Link Intelligent Device Port: Extended Unit

Text Data Mode: 1 [Change](#)

Communication Settings

Speed: 156Kbps

Timeout: 3 (sec)

Retry: 2

Station number: 1

Number of occupied stations: 1 station(s)

Input data status on data link error:  Retained  Clear

Remote READY flag:  Not use  Use

CC-Link Version: Ver 1

CC-Link Ver2 Setting

Extended cyclic setting: 1 time

Default

Device-Specific Settings

Allowable Number of Devices/PLCs: 27

Number	Device Name	Settings
1	PLC1	Series=Melsec A Series / Q Series A Mode, Station number=0

##### ◆ Device Setting

To display the setting screen, click ([Setting]) of the External Device you want to set from [Device-Specific Settings] of [Device/PLC Settings]. To connect multiple External Devices, click from [Device-Specific Settings] of [Device/PLC Settings] to add another External Device.

Individual Device Settings

PLC1

Series: Melsec A Series / Q Series A Mode

Please reconfirm all of address settings that you are using if you have changed the series.

Station number: 0

Default

OK (O) Cancel

## ■ Settings of External Device

To configure communication settings, use the DIP switches and rotary switches on the External Device, and the ladder software (GX-Developer). After completing the settings, reboot the External Device to enable them. Please refer to the manual of the External Device for details.

### ◆ DIP Switch

DIP Switch	Settings	Setup Description
SW1	OFF	Number of occupied stations (OFF: Master station ON: Local station)
SW2	OFF	Always OFF
SW3	OFF	Always OFF
SW4	OFF	Data status of data link error station (OFF: Clear ON: Retained)
SW5	OFF	Number of occupied stations (OFF: 1 station occupied ON: 4 stations occupied)
SW6	OFF	Always OFF
SW7	OFF	Always OFF
SW8	OFF	Always OFF

### ◆ Station Setting Rotary Switch

Rotary Switch	Settings	Setup Description
x 10	0	Station No. of the External Device (tens digit)
x 1	0	Station No. of the External Device (ones digit)

#### **NOTE**

- Always assign "00" to the master station, and the station No. to the local station.

### ◆ Mode Setting Rotary Switch

Rotary Switch	Settings	Setup Description
MODE	0	Online

### ◆ Baud Rate Setting Rotary Switch

Rotary Switch	Settings	Setup Description
B RATE	0	156Kbps

### ◆ Using the Ladder Software for Settings

Start up the ladder software, and program as follows.

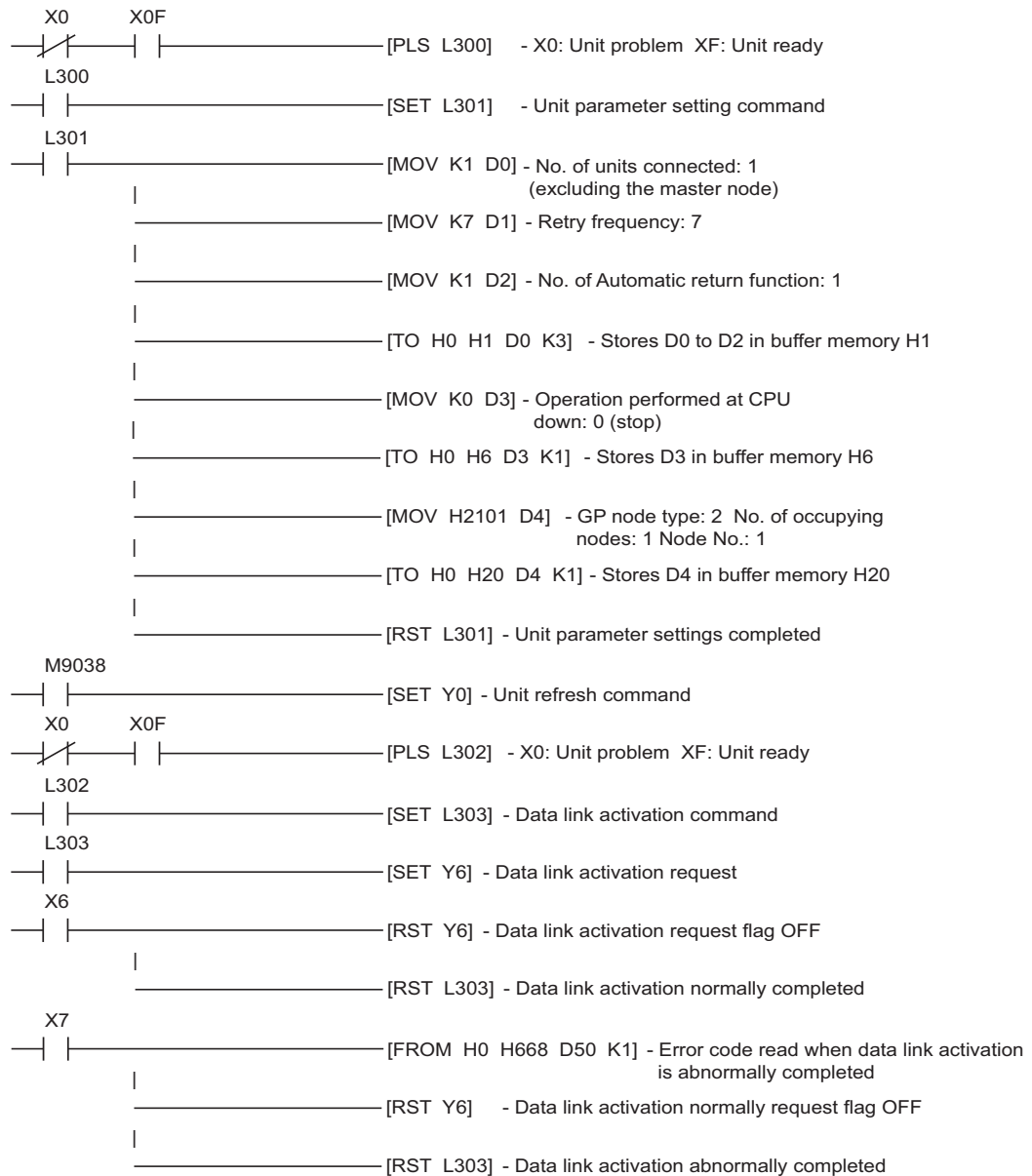

## 3.2 Setting Example 2

### ■ Settings of GP-Pro EX

#### ◆ Communication Settings

To display the setting screen, select [Device/PLC Settings] from [System setting window] in workspace.

Device/PLC 1

Summary [Change Device/PLC](#)

Maker  Series  Port

Text Data Mode  [Change](#)

Communication Settings

Speed

Timeout  (sec)

Retry

Station number

Number of occupied stations  station(s)

Input data status on data link error  Retained  Clear

Remote READY flag  Not use  Use

CC-Link Version

CC-Link Ver2 Setting

Extended cyclic setting

Device-Specific Settings

Allowable Number of Devices/PLCs 27

Number	Device Name	Settings
<input type="button" value="1"/>	<input type="text" value="PLC1"/>	<input type="text" value="Series=Melsec Q Series / QnA Series.Station number=0"/>

#### ◆ Device Setting

To display the setting screen, click  ([Setting]) of the External Device you want to set from [Device-Specific Settings] of [Device/PLC Settings]. To connect multiple External Devices, click  from [Device-Specific Settings] of [Device/PLC Settings] to add another External Device.

Individual Device Settings

PLC1

Series

Please reconfirm all of address settings that you are using if you have changed the series.

Station number

## ■ Settings of External Device

To configure communication settings, use the DIP switches and rotary switches on the External Device, and the ladder software (GX-Developer). After completing the settings, reboot the External Device to enable them. Please refer to the manual of the External Device for details.

### ◆ DIP Switch

DIP Switch	Settings	Setup Description
SW1	OFF	Number of occupied stations (OFF: Master station ON: Local station)
SW2	OFF	Always OFF
SW3	OFF	Always OFF
SW4	OFF	Data status of data link error station (OFF: Clear ON: Retained)
SW5	OFF	Number of occupied stations (OFF: 1 station occupied ON: 4 stations occupied)
SW6	OFF	Always OFF
SW7	OFF	Always OFF
SW8	OFF	Always OFF

### ◆ Station Setting Rotary Switch

Rotary Switch	Settings	Setup Description
x 10	0	Station No. of the External Device (tens digit)
x 1	0	Station No. of the External Device (ones digit)

#### NOTE

- Always assign "00" to the master station, and the station No. to the local station.

### ◆ Mode Setting Rotary Switch

Rotary Switch	Settings	Setup Description
MODE	0	Online

### ◆ Baud Rate Setting Rotary Switch

Rotary Switch	Settings	Setup Description
B RATE	0	156Kbps





### 3.3 Setting Example 3

#### ■ Settings of GP-Pro EX

##### ◆ Communication Settings

To display the setting screen, select [Device/PLC Settings] from [System setting window] in workspace.

Device/PLC 1

Summary [Change Device/PLC](#)

Maker  Series  Port

Text Data Mode  [Change](#)

Communication Settings

Speed

Timeout  (sec)

Retry

Station number

Number of occupied stations  station(s)

Input data status on data link error  Retained  Clear

Remote READY flag  Not use  Use

CC-Link Version

CC-Link Ver2 Setting

Extended cyclic setting

Device-Specific Settings

Allowable Number of Devices/PLCs 27

Number	Device Name	Settings
<input type="button" value="1"/>	<input type="text" value="PLC1"/>	<input type="text" value="Series=Melsec Q Series / QnA Series.Station number=0"/>

##### ◆ Device Setting

To display the setting screen, click  ([Setting]) of the External Device you want to set from [Device-Specific Settings] of [Device/PLC Settings]. To connect multiple External Devices, click  from [Device-Specific Settings] of [Device/PLC Settings] to add another External Device.

Individual Device Settings

PLC1

Series

Please reconfirm all of address settings that you are using if you have changed the series.

Station number

## ■ Settings of External Device

To configure communication settings, use the DIP switches and rotary switches on the External Device, and the ladder software (GX-Developer). After completing the settings, reboot the External Device to enable them. Please refer to the manual of the External Device for details.

### ◆ DIP Switch

DIP Switch	Settings	Setup Description
SW1	OFF	Number of occupied stations (OFF: Master station ON: Local station)
SW2	OFF	Always OFF
SW3	OFF	Always OFF
SW4	OFF	Data status of data link error station (OFF: Clear ON: Retained)
SW5	OFF	Number of occupied stations (OFF: 1 station occupied ON: 4 stations occupied)
SW6	OFF	Always OFF
SW7	OFF	Always OFF
SW8	OFF	Always OFF

### ◆ Station Setting Rotary Switch

Rotary Switch	Settings	Setup Description
x 10	0	Station No. of the External Device (tens digit)
x 1	0	Station No. of the External Device (ones digit)

#### NOTE

- Always assign "00" to the master station, and the station No. to the local station.

### ◆ Mode Setting Rotary Switch

Rotary Switch	Settings	Setup Description
MODE	0	Online

### ◆ Baud Rate Setting Rotary Switch

Rotary Switch	Settings	Setup Description
B RATE	0	156Kbps

◆ Using the Ladder Software for Settings

- 1 Start up the ladder software.
- 2 Double-click [Network Parameter] under [Parameter].
- 3 Click [CC-Link] in the [Network Parameter] dialog box.
- 4 Configure the following settings in the window that appears.

Setup Items	Setting
No. of Unit Sheets	1
Head I/O No.	0000
Type	Master station
Mode Setting <sup>*1</sup>	Remote Net Ver.1 Mode
Number of Connectable Units	1

\*1 [Mode Setting] is not available to ladder software earlier than version 8.03D.  
CC-Link Ver.1 is selected.

- 5 Click [Station Information].
- 6 Configure the following settings in the [CC-Link Station Unit 1] dialog box that appears.

Setup Items	Setting
Station Type	Intelligent device station
Number of Occupied Stations	1 station occupied.

- 7 Save the communication settings and transfer them to the External Device.



## 3.4 Setting Example 4

### ■ Settings of GP-Pro EX

#### ◆ Communication Settings

To display the setting screen, select [Device/PLC Settings] from [System setting window] in workspace.

#### ◆ Device Setting

To display the setting screen, click  ([Setting]) of the External Device you want to set from [Device-Specific Settings] of [Device/PLC Settings]. To connect multiple External Devices, click  from [Device-Specific Settings] of [Device/PLC Settings] to add another External Device.

## ■ Settings of External Device

To configure communication settings, use the rotary switches on the External Device, and the ladder software (GX-Developer Version 8.03D). After completing the settings, reboot the External Device to enable them. Please refer to the manual of the External Device for details.

### ◆ Station Setting Rotary Switch

Rotary Switch	Settings	Setup Description
x 10	0	Station No. of the External Device (tens digit)
x 1	0	Station No. of the External Device (ones digit)

#### NOTE

- Always assign "00" to the master station, and the station No. to the local station.

### ◆ Mode Setting Rotary Switch

Rotary Switch	Settings	Setup Description
MODE	0	Online

### ◆ Using the Ladder Software for Settings

- 1 Start up the ladder software.
- 2 Double-click [Network Parameter] under [Parameter].
- 3 Click [CC-Link] in the [Network Parameter] dialog box.
- 4 Configure the following settings in the window that appears.

Setup Items	Setting
No. of Unit Sheets	1
Head I/O No.	0000
Type	Master station
Mode Setting*1	Remote Net Ver.1 Mode
Number of Connectable Units	1

\*1 [Mode Setting] is not available to ladder software earlier than version 8.03D.  
CC-Link Ver.1 is selected.

- 5 Click [Station Information].
- 6 Configure the following settings in the [CC-Link Station Unit 1] dialog box that appears.

Setup Items	Setting
Station Type	Intelligent device station
Number of Occupied Stations	1 station occupied.

- 7 Save the communication settings and transfer them to the External Device.



## 3.5 Setting Example 5

### ■ Settings of GP-Pro EX

#### ◆ Communication Settings

To display the setting screen, select [Device/PLC Settings] from [System setting window] in workspace.

#### ◆ Device Setting

To display the setting screen, click  ([Setting]) of the External Device you want to set from [Device-Specific Settings] of [Device/PLC Settings]. To connect multiple External Devices, click  from [Device-Specific Settings] of [Device/PLC Settings] to add another External Device.

## ■ Settings of External Device

To configure communication settings, use the rotary switches on the External Device, and the ladder software (GX-Developer Version 8.03D). After completing the settings, reboot the External Device to enable them. Please refer to the manual of the External Device for details.

### ◆ Station Setting Rotary Switch

Rotary Switch	Settings	Setup Description
x 10	0	Station No. of the External Device (tens digit)
x 1	0	Station No. of the External Device (ones digit)

#### **NOTE**

- Always assign "00" to the master station, and the station No. to the local station.

### ◆ Mode Setting Rotary Switch

Rotary Switch	Settings	Setup Description
MODE	0	Online

### ◆ Using the Ladder Software for Settings

Use version 8.03D or later of the ladder software.

- 1 Start up the ladder software.
- 2 Double-click [Network Parameter] under [Parameter].
- 3 Click [CC-Link] in the [Network Parameter] dialog box.
- 4 Configure the following settings in the window that appears.

Setup Items	Setting
No. of Unit Sheets	1
Head I/O No.	0000
Type	Master station
Mode Setting	Remote Net Ver.2 Mode
Number of Connectable Units	1

- 5 Click [Station Information].
- 6 Configure the following settings in the [CC-Link Station Unit 1] dialog box that appears.

Setup Items	Setting
Station Type	Intelligent device station Ver.2
Extended Cyclic Setting	1 time setting
Number of Occupied Stations	1 station occupied.

- 7 Save the communication settings and transfer them to the External Device.



## 4 Setup Items

Set the communication settings of the Display with GP-Pro Ex or in off-line mode of the Display.

The setting of each parameter must be identical to that of the External Device.

 "3 Example of Communication Setting" (page 12)

### 4.1 Setup Items in GP-Pro EX

#### ■ Communication Settings

To display the setting screen, select [Device/PLC Settings] from [System setting window] in workspace.

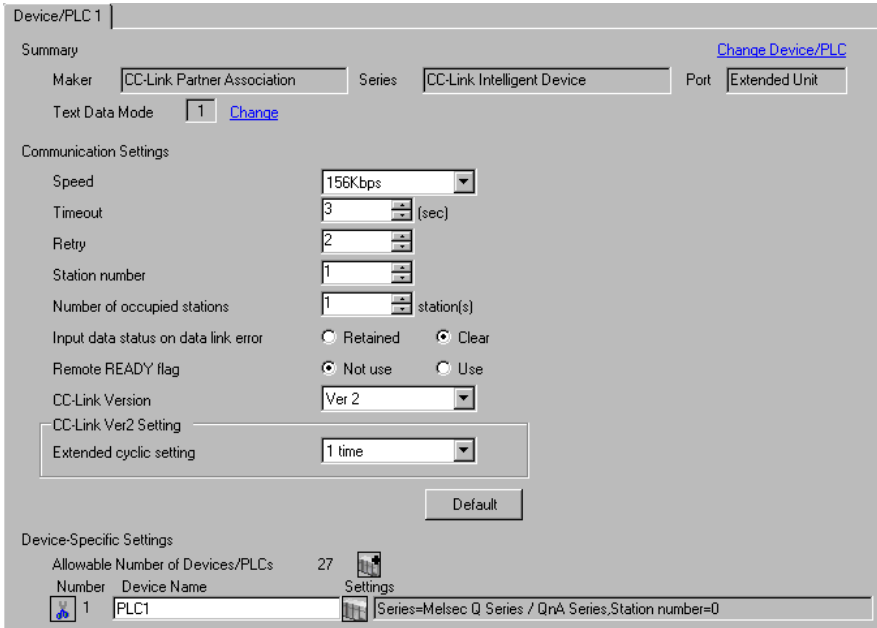

Setup Items	Setup Description
Speed	Select the communication speed between the External Device and the Display.
Timeout	Enter the time (s) for which the Display waits for the response from the External Device, from "1 to 127".
Retry	In case of no response from the External Device, enter how many times the Display retransmits the command, from "0 to 255".
Station number	Enter a station No. for the slave station, from "1 to 64".
Number of occupied stations	Enter the number of stations on the network that one slave station occupies, from "1 to 4".
Input data status on data link error	If an error occurs on the data link, select the input data status, from "Retained" or "Clear".
Remote READY flag	Select whether to use the remote READY flag for remote I/O signals, from "Not use" or "Use".
CC-Link Version	Select the CC-Link version, from "Ver 1" or "Ver 2".
Extended cyclic setting	Select the setting for extending the cyclic points in the extended cyclic transmission, from "1 time", "2 times", "4 times", or "8 times". Available only when the CC-Link version is set to "Ver 2".

## ■ Device Setting

To display the setting screen, click  ([Setting]) of the External Device you want to set from [Device-Specific Settings] of [Device/PLC Settings].

To connect multiple External Devices, click  from [Device-Specific Settings] of [Device/PLC Settings] to add another External Device.



Setup Items	Setup Description
Series	Select the model of the External Device.
Station number	Enter a station No. for the master station or the slave station, from "0 to 64". Always assign "0" to the master station.

### NOTE

- If you have changed the series, reconfirm the addresses in use.

## 4.2 Setup Items in Off-line Mode

**NOTE**

- Please refer to the Maintenance/Troubleshooting manual for more information on how to enter off-line mode or about the operation.

Cf. Maintenance/Troubleshooting Manual "2.2 Off-line Mode"

### ■ Communication Settings

To display the setting screen, touch [Device/PLC Settings] from [Peripheral Equipment Settings] in off-line mode. Touch the External Device you want to set from the list that appears.

Comm.	Device			
CC-Link Intelligent Device		Page 1/1		
Speed		156Kbps		
Timeout(s)		3	▼ ▲	
Retry		2	▼ ▲	
Station number		1	▼ ▲	
Number of occupied stations		1	▼ ▲	
Input data status on data link error				
		<input type="radio"/> Retained	<input checked="" type="radio"/> Clear	
Remote READY flag		<input checked="" type="radio"/> Not use	<input type="radio"/> Use	
CC-Link Version		Ver 1	▼	
CC-Link Ver2 Setting				
Extended cyclic setting		1 time	▼	
		Exit	Back	2007/09/21 22:42:25

Setup Items	Setup Description
Speed	Select the communication speed between the External Device and the Display.
Timeout	Enter the time (s) for which the Display waits for the response from the External Device, from "1 to 127".
Retry	In case of no response from the External Device, enter how many times the Display retransmits the command, from "0 to 255".
Station number	Enter a station No. for the slave station, from "1 to 64".
Number of occupied stations	Enter the number of stations on the network that one slave station occupies, from "1 to 4".
Input data status on data link error	If an error occurs on the data link, select the input data status, from "Retained" or "Clear".
Remote READY flag	Select whether to use the remote READY flag for remote I/O signals, from "Not use" or "Use".
CC-Link Version	Select the CC-Link version, from "Ver 1" or "Ver 2".
Extended cyclic setting	Select the setting for extending the cyclic points in the extended cyclic transmission, from "1 time", "2 times", "4 times", or "8 times". Available only when the CC-Link version is set to "Ver 2".

## ■ Device Setting

To display the setting screen, touch [Device/PLC Settings] from [Peripheral Equipment Settings]. Touch the External Device you want to set from the displayed list, and touch [Device Settings].

Comm.	Device			
CC-Link Intelligent Device				Page 1/1
Device/PLC Name		PLC1		
Series		Melsec Q Series / QnA Series		
Station number		0		
Exit		Back		2007/09/21 22:42:30

Setup Items	Setup Description
Device/PLC Name	Select the External Device to set. Device name is the title of the External Device set with GP-Pro EX. (Initial value [PLC1])
Series	Displays the model of the External Device.
Station number	Enter a station No. for the master station or the slave station, from "0 to 64". Always assign "0" to the master station.

## 5 Cable Diagram

The cable diagram shown below may differ from that recommended by the CC-Link Partner Association. Please be assured, however, that there is no operational problem in applying the cable diagram shown in this manual.

- The FG pin on the External Device must be D-class grounded. Please refer to the manual of the External Device for details.
- The SG and FG are connected inside the Display. If you connect the External Device to the SG, do not form any short-circuit loop in the system design.

### ■ Recommended cable

Maker	Model No.	(Standard) Termination Resistance	Remarks
Kuramo Electric Co., LTD.	FANC-SB	110 1/2W	CC-Link V1.00 dedicated cable
	FANC-SBH	130 1/2W	CC-Link V1.00 dedicated high-performance cable
	FANC-SB110H	110 1/2W	CC-Link V1.10 dedicated cable

Cable Diagram 1

Display (Connection Port)	Cable	Remarks
GP*1 (Expansion unit)	CC-Link unit by Pro-face (Intelligent device station) CA7-CCLALL/EX-01 + CC-Link cable	-

\*1 All GP models except the GP-3200 Series

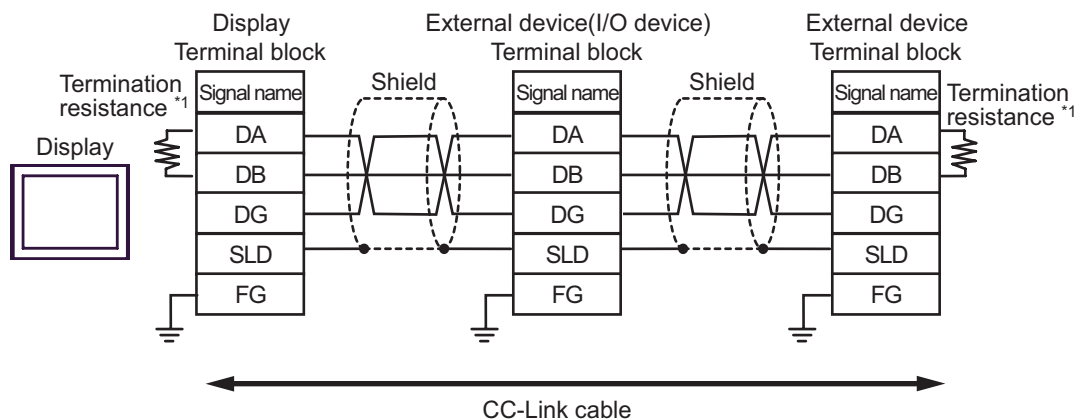

- \*1 Connect the termination resistors that came with the master unit to both end devices on the data link (between DA and DB). Note that the termination resistance varies depending on the cable type. For details on the termination resistance and cable length, refer to Mitsubishi Electric CC-Link Master Unit Manual.





**IMPORTANT**

- Make sure to use a CC-Link dedicated cable for the CC-Link system.
  - Do not mix different types of cables.
  - Connect the shield wires to the "SLD" on each unit. The "SLD" is connected internally to the FG, and so a D-class ground is required for each pin.
  - For details on T-branch connections, refer to Mitsubishi Electric CC-Link Master Unit Manual.
-

## 6 Supported Devices

The following table shows the range of supported device addresses. Note that the actually supported range varies depending on the External Device to be used. Please check the actual range in the manual of your External Device.

### 6.1 Cyclic Transmission (Common to All Models)

Device	Bit Address	Word Address	32 bits	Remarks
Remote Input	RX0000 - RX1FFF	RX0000 - RX1FF0	<b>L/H</b>	 *1
Remote Output	RY0000 - RY1FFF	RY0000 - RY1FF0		 *2
Remote Register (Writing area)	RWw000.0 - RWw7FF.F	RWw000 - RWw7FF		 *2
Remote Register (Reading area)	RWr000.0 - RWr7FF.F	RWr000 - RWr7FF		 *1

\*1 Write disable

\*2 Writing is allowed only to the range assigned to the source station. Writing beyond the range will not reflect any value, though no error occurs.

#### NOTE

- "RX", "RY", "RWw", and "RWr" are the names used on the Display. On the master station, these assigned names will become opposite.

















	Assigned Name			
Display	RX	RY	RWw	RWr
External Device	RY	RX	RWr	RWw

- If multiple External Devices are registered, the cyclic transmission range will have the same values, whichever External Device is specified.
- Please refer to the precautions on manual notation for icons in the table.

 "Manual Symbols and Terminology"

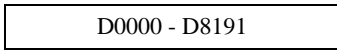
## 6.2 Transient Transmission (MELSEC A Series/Q Series A Mode)

 : This address can be specified as system data area.

Device	Bit Address	Word Address	32 bit	Remarks
Input	X0000 - X1FFF	X0000 - X1FF0	<b>L/H</b>	 *1
Output	Y0000 - Y1FFF	Y0000 - Y1FF0		 *1
Internal Relay	M0000 - M8191	M0000 - M8176		 *1
Latch Relay	L00000 - L08191	L00000 - L08176		 *1
Link Relay	B0000 - B1FFF	B0000 - B1FF0		 *1
Special Relay	M9000 - M9255	M9000 - M9240		 *1 *2
Timer (Contact)	TS00000 - TS02047	TS00000 - TS02032		 *1
Timer (Coil)	TC00000 - TC02047	TC00000 - TC02032		 *1
Counter (Contact)	CS00000 - CS01023	CS00000 - CS01008		 *1
Counter (Coil)	CC00000 - CC01023	CC00000 - CC01008		 *1
Timer (Current Value)	-	TN00000 - TN02047		 15
Counter (Current Value)	-	CN00000 - CN01023		 15
Data Register	-	 D0000 - D8191		 15
Link Register	-	W0000 - W1FFF		 F
File Register	-	R00000 - R08191		 15
Special Register	-	D9000 - D9255		 15 *3

\*1 When bits are written, the Display reads the corresponding word address from the External Device, sets particular bits of that word address to ON, and then returns the resulting address to the External Device. Note that the correct data may not be written if you change the word address using the ladder program while the Display reads data from the External Device and returns it.

\*2 When specifying special relay devices, select "M9xxx" in GP-Pro EX.

\*3 When specifying special register devices, select "D9xxx" in GP-Pro EX.

**IMPORTANT**

- The annunciator, step relay, and file register (serial number) devices are not accessible.

**NOTE**

- Please refer to the GP-Pro EX Reference Manual for system data area.  
Cf. GP-Pro EX Reference Manual "Appendix 1.4 LS Area (only for direct access method)"
- Please refer to the precautions on manual notation for icons in the table.  
 "Manual Symbols and Terminology"



## 6.3 Transient Transmission (MELSEC QnA Series/Q Series)

     : This address can be specified as system data area.

Device	Bit Address	Word Address	32 bit	Remarks
Input Relay	X0000 - X1FFF	X0000 - X1FF0	<b>L/H</b>	<span style="border: 1px solid black; padding: 2px;">***0</span> *1
Output Relay	Y0000 - Y1FFF	Y0000 - Y1FF0		<span style="border: 1px solid black; padding: 2px;">***0</span> *1
Internal Relay	M00000 - M32767	M00000 - M32752		<span style="border: 1px solid black; padding: 2px;">÷16</span> *1
Special Relay	SM0000 - SM2047	SM0000 - SM2032		<span style="border: 1px solid black; padding: 2px;">÷16</span> *1
Latch Relay	L00000 - L32767	L00000 - L32752		<span style="border: 1px solid black; padding: 2px;">÷16</span> *1
Link Relay	B0000 - B7FFF	B0000 - B7FF0		<span style="border: 1px solid black; padding: 2px;">***0</span> *1
Special Link Relay	SB0000 - SB7FFF	SB0000 - SB7FF0		<span style="border: 1px solid black; padding: 2px;">***0</span> *1
Timer (Contact)	TS00000 - TS25023	TS00000 - TS25008		<span style="border: 1px solid black; padding: 2px;">÷16</span> *1
Timer (Coil)	TC00000 - TC25023	TC00000 - TC25008		<span style="border: 1px solid black; padding: 2px;">÷16</span> *1
Retentive Timer (Contact)	SS00000 - SS25023	SS00000 - SS25008		<span style="border: 1px solid black; padding: 2px;">÷16</span> *1
Retentive Timer (Coil)	SC00000 - SC25023	SC00000 - SC25008		<span style="border: 1px solid black; padding: 2px;">÷16</span> *1
Counter (Contact)	CS00000 - CS25023	CS00000 - CS25008		<span style="border: 1px solid black; padding: 2px;">÷16</span> *1
Counter (Coil)	CC00000 - CC25023	CC00000 - CC25008		<span style="border: 1px solid black; padding: 2px;">÷16</span> *1
Timer (Current Value)	-	TN00000 - TN25023		<span style="border: 1px solid black; padding: 2px;">Bit F</span>
Retentive Timer (Current Value)	-	SN00000 - SN25023		<span style="border: 1px solid black; padding: 2px;">Bit F</span>
Counter (Current Value)	-	CN00000 - CN25023		<span style="border: 1px solid black; padding: 2px;">Bit F</span>
Data Register	-	D00000 - D28159		<span style="border: 1px solid black; padding: 2px;">Bit F</span>
Special Register	-	SD00000 - SD02047		<span style="border: 1px solid black; padding: 2px;">Bit F</span>
Link Register	-	W0000 - W657F		<span style="border: 1px solid black; padding: 2px;">Bit F</span>
Special Link Register	-	SW0000 - SW07FF		<span style="border: 1px solid black; padding: 2px;">Bit F</span>
File Register	-	R00000 - R32767	<span style="border: 1px solid black; padding: 2px;">Bit F</span>	

\*1 When bits are written, the Display reads the corresponding word address from the External Device, sets particular bits of that word address to ON, and then returns the resulting address to the External Device. Note that the correct data may not be written if you change the word address using the ladder program while the Display reads data from the External Device and returns it.

**IMPORTANT**

- The annunciator, step relay, and file register (serial number) devices are not accessible.

**NOTE**

- Please refer to the GP-Pro EX Reference Manual for system data area.
- Cf. GP-Pro EX Reference Manual "Appendix 1.4 LS Area (only for direct access method)"
- Please refer to the precautions on manual notation for icons in the table.  
 "Manual Symbols and Terminology"

## 7 Device Code and Address Code

Use device code and address code when you select "Device Type & Address" for the address type of the data display or other devices.

### 7.1 Cyclic Transmission (Common to All Models)

Device	Device Name	Device Code (HEX)	Address Code
Remote Input	RX	0030	Value of word address divided by 0x10
Remote Output	RY	0031	Value of word address divided by 0x10
Remote Register (Writing area)	RWw	0032	Word Address
Remote Register (Reading area)	RW <sub>r</sub>	0033	Word Address

### 7.2 Transient Transmission (MELSEC A Series/Q Series A Mode)

Device	Device Name	Device Code (HEX)	Address Code
Input	X	0080	Value of word address divided by 0x10
Output	Y	0081	Value of word address divided by 0x10
Internal Relay	M	0082	Value of word address divided by 16
Latch Relay	L	0084	Value of word address divided by 16
Link Relay	B	0088	Value of word address divided by 0x10
Special Relay	M9	0083	Value of word address divided by 16
Timer (Contact)	TS	00E0	Value of word address divided by 0x10
Timer (Coil)	TC	00E1	Value of word address divided by 0x10
Counter (Contact)	CS	00E2	Value of word address divided by 0x10
Counter (Coil)	CC	00E3	Value of word address divided by 0x10
Timer (Current Value)	TN	0060	Word Address
Counter (Current Value)	CN	0061	Word Address
Data Register	D	0000	Word Address
Link Register	W	0002	Word Address
File Register	R	000F	Word Address
Special Register	D9	0001	Word Address

## 7.3 Transient Transmission (MELSEC QnA Series/Q Series)

Device	Device Name	Device Code (HEX)	Address Code
Input Relay	X	0080	Value of word address divided by 0x10
Output Relay	Y	0081	Value of word address divided by 0x10
Internal Relay	M	0082	Value of word address divided by 16
Special Relay	SM	0083	Value of word address divided by 16
Latch Relay	L	0084	Value of word address divided by 16
Link Relay	B	0088	Value of word address divided by 0x10
Special Link Relay	SB	0089	Value of word address divided by 0x10
Timer (Contact)	TS	00E0	Value of word address divided by 0x10
Timer (Coil)	TC	00E1	Value of word address divided by 0x10
Retentive Timer (Contact)	SS	00E4	Value of word address divided by 0x10
Retentive Timer (Coil)	SC	00E5	Value of word address divided by 0x10
Counter (Contact)	CS	00E2	Value of word address divided by 0x10
Counter (Coil)	CC	00E3	Value of word address divided by 0x10
Timer (Current Value)	TN	0060	Word Address
Retentive Timer (Current Value)	SN	0062	Word Address
Counter (Current Value)	CN	0061	Word Address
Data Register	D	0000	Word Address
Special Register	SD	0001	Word Address
Link Register	W	0002	Word Address
Special Link Register	SW	0003	Word Address
File Register	R	000F	Word Address

## 8 Error Messages

Error messages are displayed on the Display screen as follows: "No.: Device Name: Error Message (Error Occurrence Area)". Each description is shown below.

Item	Description
No.	Error No.
Device Name	Name of the External Device where an error has occurred. Device name is the title of the External Device set with GP-Pro EX. (Initial value [PLC1])
Error Message	Displays messages related to an error that has occurred.
Error Occurrence Area	<p>Displays the IP address or device address of the External Device where an error has occurred, or error codes received from the External Device.</p> <p><b>NOTE</b></p> <ul style="list-style-type: none"> <li>• IP address is displayed as "IP address (Decimal): MAC address (Hex)".</li> <li>• Device address is displayed as "Address: Device address".</li> <li>• Received error codes are displayed as "Decimal [Hex]".</li> </ul>

Display Examples of Error Messages

"RHAA035: PLC1: Error has been responded for device write command (Error Code: 2[02H])"

**NOTE**

- Please refer to the manual of the External Device for details on received error codes.
- Please refer to "When an error is displayed (Error Code List)" in "Maintenance/Troubleshooting manual" for details on the error messages common to the driver.

### ■ Error Messages Specific to the External Device

Error No.	Message	Solution
RHxx128	Station number of occupied is over 64.	Appears if the station No. is set to a number greater than 64 in the setting for occupied stations.
RHxx129	Extend unit initial error.	Appears if an error occurs in the CC-Link expansion unit during initialization. Contact the Digital Support Center.
RHxx130	Communication error on the network.	Appears if a line fault occurs. Check the line. A data link error occurs if the CC-Link version or other setting is incorrect. Check the settings.
RHxx131	No response from extend unit.	Appears if the system detects an error while checking for a CC-Link expansion unit. Contact the Digital Support Center.
RHxx132	Could not send the data to PLC. (Error Code: HEX)	This can occur if a line fault occurs. Check the line.

