

Device/PLC Connection Manuals



About the Device/PLC Connection Manuals

Prior to reading these manuals and setting up your device, be sure to read the "Important: Prior to reading the Device/PLC Connection manual" information. Also, be sure to download the "Preface for Trademark Rights, List of Units Supported, How to Read Manuals and Documentation Conventions" PDF file. Furthermore, be sure to keep all manual-related data in a safe, easy-to-find location.

4 n:1 (Multi-link)

This chapter describes the overview of n:1 (multi-link) communications and the necessary steps for preparing multi-link communications.

4.1 n:1 About Multi-link

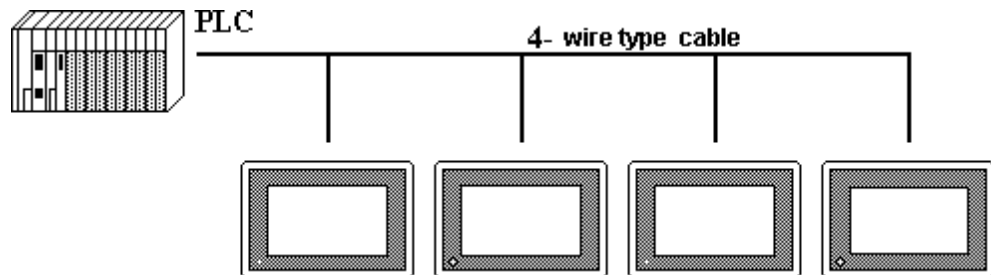

The communication software supports Programless **n:1** (multi-link) connections, whereby multiple GPs are connected to a single PLC.

In **n:1** (multi-link) communication, a token, which authorizes PLC communication, is passed successively among the GPs so that communication with the PLC occurs in an orderly fashion.

The maximum total length of the cables is 600m. However, when the maximum extended length for the PLC is less than this, model the setup after the PLC value.

- **Connection multiple GP units to one PLC**

Multiple GPs can be connected to each PLC computer (top unit) Link I/F. Maximum 16 connections are possible; for most practical purposes, use up to 4 connections.

- **Programless Communication**

A particular program for **n:1** (multi-link) is not necessary, as the selected Programless protocol can also be used in the multi-link format.

- **Multi-link connections possible without exclusive hardware**

- **from Large to Medium sized GP units**

Large and Medium sized GP-*70, GP-77R and GP2000 Series displays can be connected in a *random* order in **n:1** (multi-link) communication.

- **GP screen data designed for 1:1 connection**

The multi-link connection can even use GP screen data designed for a **1:1** connection.

•Maintenance possible on connected GP

In the middle of RUN mode for a **n:1** (multi-link) connection, the communication of a *free* GP can be stopped. This function is available so that adding or editing screen data, turning the GP power On/Off, debugging, maintenance, and so on, can be performed without disrupting the system.



- In GP's INITIALIZE/PLC SETUP/STATION SETUP screen, enter the same NETWORK INFORMATION ADDRESS for all connected GP's.
- Because increasing the number of GP connections slows the GP display and operation speed, consider it carefully at the end of your system calculations.
- To utilize display efficiency, set up the tag addresses consecutively; when tag addresses are *not* consecutive, the processing speed decreases.
- The PLC Scan Time (cycle time) affects the base system's response time.
- When the PLC power is turned off during communication, a communication error may appear on the GP.
- When a connector hood is used to ground the FG line at the end of the GP—PLC connection, use an electric conductor.



Entering touch input on multiple GPs at the same time may increase the time it takes for the PLC to respond. This occurs because the first screen must refresh its display before the second display can receive its reply. As a result, do not use both GP units at the same time.



When GP-*30 series and GP-*70 series systems are combined and n:1 (multi-link) connections are used, note that the GP-*30 systems cannot use the following functions.

- **PLC exclusive usage that uses the system data area's LS14.**
- **Function for informing other GPs when a single GP has exclusive use of the PLC.**
- **Time for release of exclusive use.**

<Matrix showing GP recognition of PLC Monopoly>

GP-*30 series	GP-*50 series	GP-*70/GP2000 series
Touch Panel Monopoly	Not recognized	Not recognized
Not recognized	Exclusive use of either touch panel or LS14	Recognized
Not recognized	Recognized	Exclusive use of the touch panel or of the LS14



For GPs that do not recognize PLC monopoly, their display is not refreshed until monopoly is released, and errors are not displayed.

Reference For information about GP-*30 series panels' exclusive use of PLCs, refer to GP series PLC connection manual, multi-link protocol

Reference For information about GP-*70 series panels' exclusive use of PLCs, refer to **Chapter 4.5, About PLC monopoly**

Also, with the GP70 series, PLCs connectability may vary depending on the models involved.

■ Option Parts

Digital's *Multi-link* type cable or RS-422 connector terminal adapter is recommended for **n:1** (multi-link) connections.

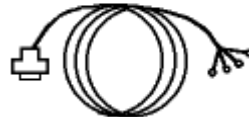

**Mitsubishi type Cable
(GP230-IS12-0)**

I/F cable (5m) to run communication between various PLCs and GP.

Can use as a secondary cable from the Relay terminal.

**RS-422 Connector Terminal
Adapter (GP070-CN10-0)**

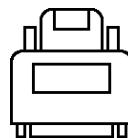

This adapter exchanges the RS-422 terminal output from the GP Series' SIO connector.

Connect with the recommended cable by the corresponding PLC maker.



4.2 Prior to RUN mode

This section outlines the steps for **n:1** (multi-link) communication. Particularly important steps have a rectangular frame.

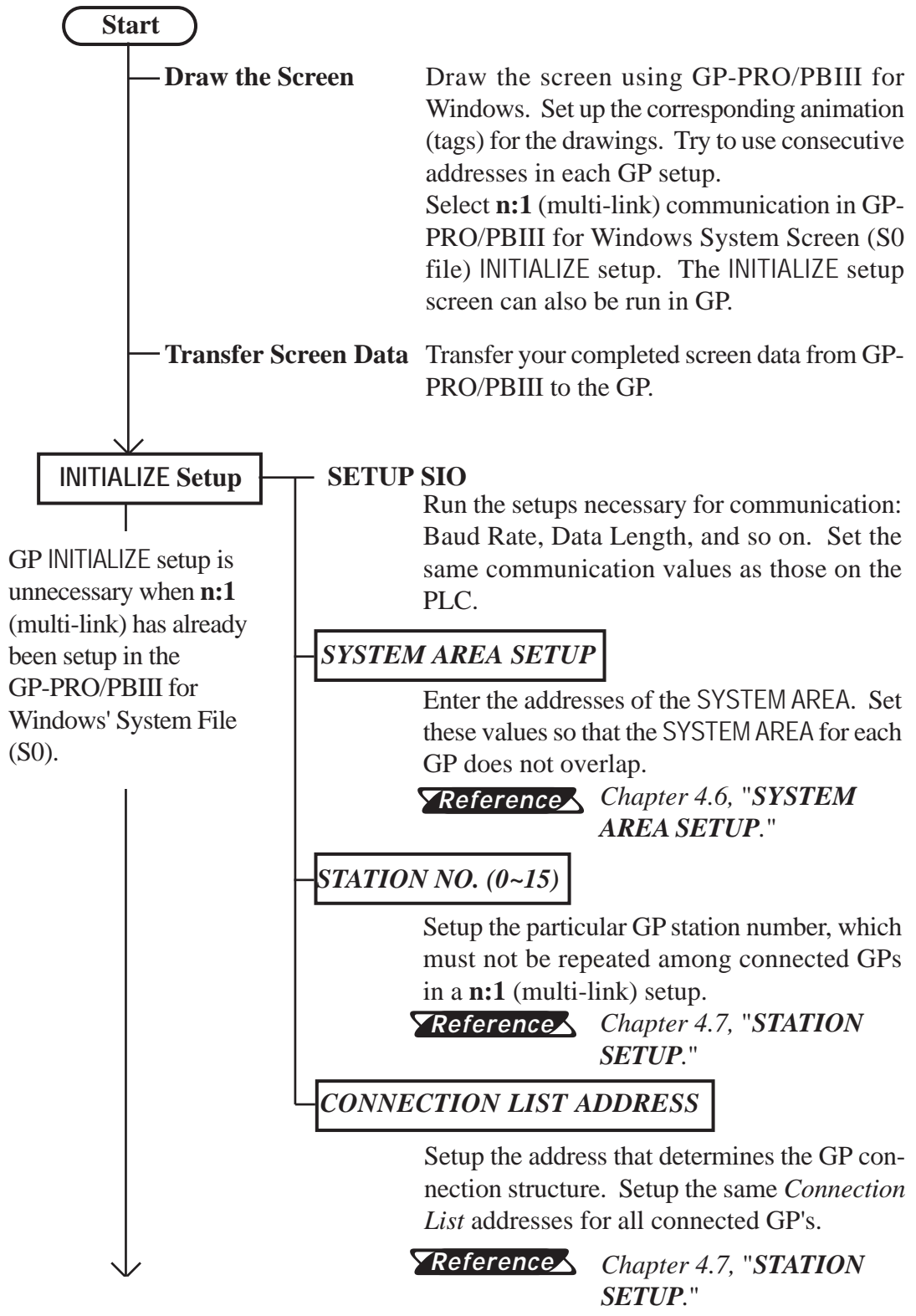

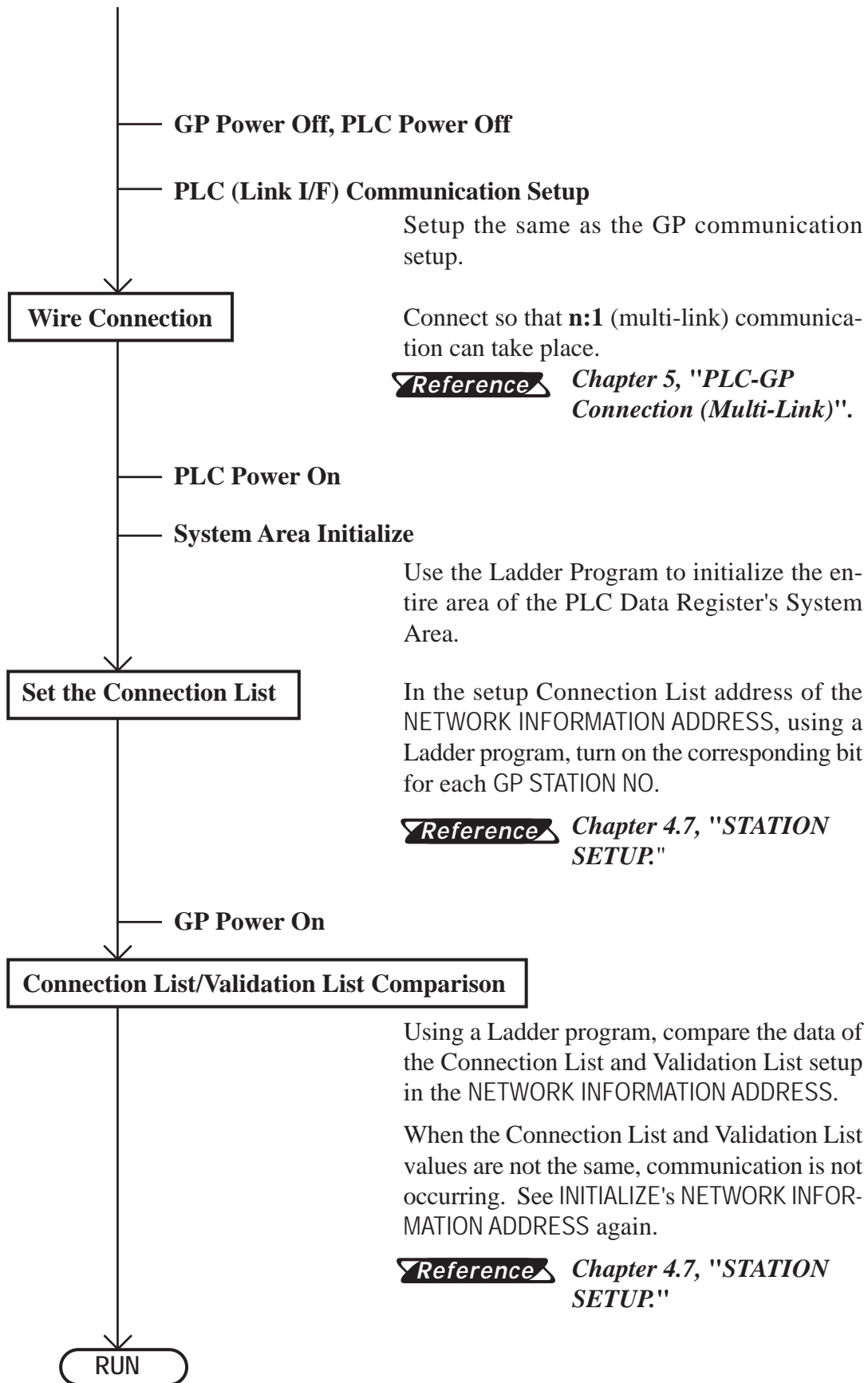

4.3 PLC Scan Time

When using the GP in **n:1** (multi-link), the PLC scan time greatly influences the GP Display/Operation speed. The time it takes to run a process series, common to PLCs, and repeated as shown in the diagram below, is known as the *scan time*. If the scan time gets longer, the Display/Operation speed, because it remains in proportion, slows down.

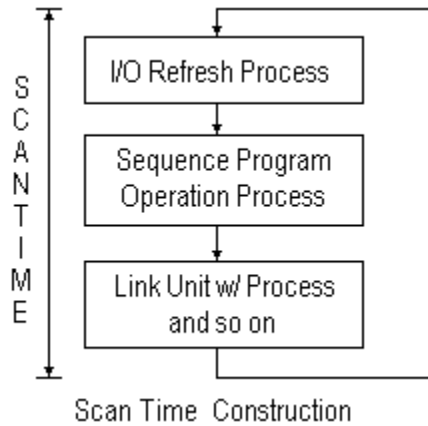

In the step *Link I/F w/ Process and so on* in the above diagram, the PLC runs the process linked to the command *from* the GP.

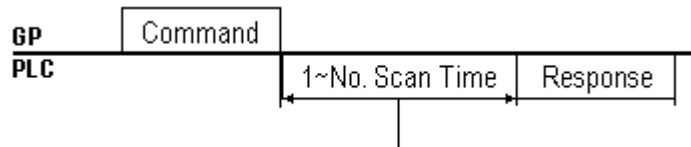

After sending a command, the time it takes for a response varies among PLC's.

Wait Time Reference Example

- MELSEC A Series
 - Read 1 Scan time
 - Write.... 2 Scan time



For details, refer to the corresponding PLC manual.

To raise (speed up) the response time, wherever possible, create a system with short scan times. (For example, for sequence program allocation and so on.)



4.4 About PLC Monopolize

A PLC monopoly occurs when one of many GPs uses the PLC exclusively. For example, use PLC monopolize when you wish to setup data using the keyboard on the GP screen, or when displaying data Input/Output on a single GP.

■ PLC Monopoly

There are two ways of monopolizing the PLC:

1. Turn bit 7 of System Area address LS14 ON,
2. Set the GP TOUCH MONOPOLIZE option ON in GP's INITIALIZE off-line menu.

Reference Chapter 4.8, "CUSTOMIZE SETUP."

■ PLC Monopoly Release

Turn OFF the #7 bit of the GP System Area's LS14.

When the PLC is used exclusively using the method stated above in (1), the time period of exclusive use can be set. After that period is over, exclusive use is automatically released.

Reference Chapter 4.8, "CUSTOMIZE SETUP."

When a GP is monopolizing the PLC, bit 7 of System Area address LS6 (Status) turns ON for the other GPs. These GPs are in a *wait* state.

Operations run in GPs in a wait state are carried out only after communication is resumed. For this reason, there is the possibility errors will occur in accumulated operations. Plus, the PLC cannot check the System Area bit of Wait and See GPs.

We recommend using L-tag and W-tag, U-tag, and so on, to display whether a GP is in Monopoly or Wait and See mode.

E.g. Make the 7th bit of System Area's LS6 (Status) the trigger bit which displays the L-tag message "Waiting".

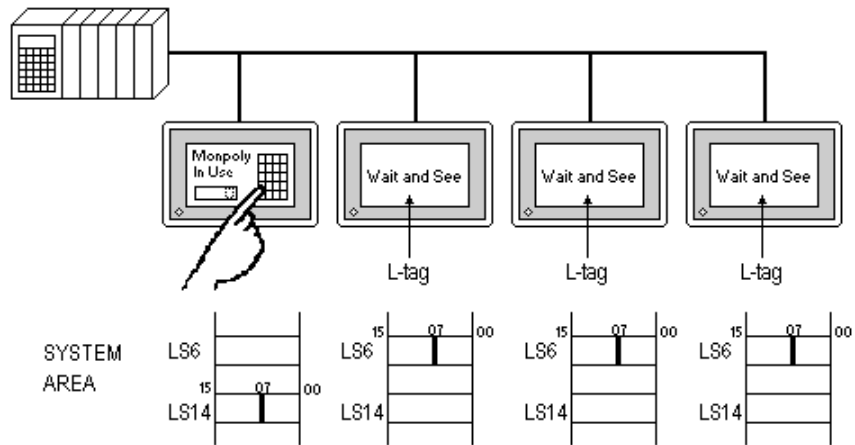

- When LS14's (Control) bit is turned ON in multiple GPs, the PLC Monopolize function is carried out on the GP whose bit turned ON first.
- While one of the GPs monopolizes the PLC, the other GP displays remain static.

4.5 SYSTEM AREA SETUP

This section's data will help you to set up the System Area*¹.

In **n:1** (multi-link) communication, to layout the System Area for the number of connected GPs, data of the entire system will increase. For this reason, the processing speed of each GP may slow down.

Selecting only necessary items for the System Area is recommended.

When setting the system data area while in the GP's off-line mode, be sure to use the [2 SYSTEM AREA SETUP], located inside the [1 INITIALIZE] menus's [2 SETUP OPERATION SURROUNDINGS] selection screen.

SYSTEM AREA SETUP		CONFIRM	CANCEL
1	CURRENT SCREEN NO. (1 WORD)	8	CLOCK DATA (SET) (4 WORDS)
2	ERROR STATUS (1 WORD)	9	CONTROL (1 WORD)
3	CLOCK DATA (CURRENT) (4 WORDS)	A	RESERVED (1 WORD)
4	STATUS (1 WORD)	B	WINDOW CONTROL (1 WORD)
5	RESERVED (1 WORD)	C	WINDOW REG. NO. (1 WORD)
6	CHANGE SCREEN NO. (1 WORD)	D	WINDOW LOCATION (2 WORDS)
7	DISPLAY ON/OFF (1 WORD)		SYSTEM AREA SIZE: WORD(S)

(Item numbers displayed in reverse mode are selected.)

(GP-470 Screen)



- Setup the System Area for all the connected GP's. Do not overlap any of the allotted PLC Data Register (D) or Data Memory (DM) addresses.
- When System Area items are not selected, the Reading Area start address becomes the System Area start address.
- There is a process where not selecting the System Area items increases the GP management speed; however, operations where the PLC controls the GP, such as a Screen Change command sent from the PLC or PLC monopolize, cannot be run.
- When you wish to change the screen despite System Area items not being selected, indirectly use W-tag's ADD mode, and write the PLC Data Register contents into GP's internal LS8.

*1 The System Area is the area necessary for the PLC to control the GP. The items selected here are allotted to the PLC's internal memory.

Reference For details about the System Area, refer to **Chapter 1.1, Direct Access Communication**.



4.6 STATION SETUP

The STATION SETUP, necessary for the **n:1** (multi-link) setup, checks whether correct communications run with the connected GP System configuration.

When setting the system data area while in the GP's OFFLINE mode, be sure to use the [2 STATION SETUP], located inside the [1 INITIALIZE] menu's [2 SET UP OPERATION SURROUNDINGS] selection screen.

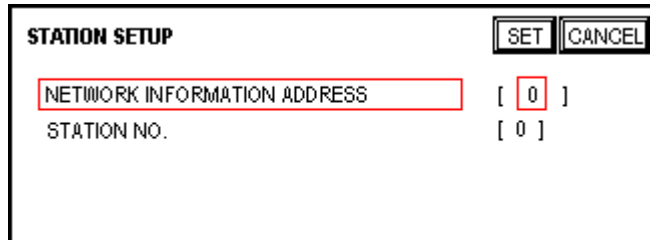

(GP-470 Screen)

- **NETWORK INFORMATION ADDRESS**

In the **n:1** (multi-link) connection, the Network Information uses 2 words in its correspondences. These 2 words are made up of the Connection List and the Validation List (described later in this section). Allocate these respective areas into the PLC's Data Register (D) or Data Memory (DM).

PLC Data Register

+ 0	CONNECTION LIST	PLC-->GP
+ 1	VALIDATION LIST	GP-->PLC



Important

In the NETWORK INFORMATION ADDRESS, set up the same address to all the GPs connected to the same Link I/F. Furthermore, when there are 2 ports or more GP units connected to either of the Link I/F, do not make them the same address.

- **Connection List**

The word address for the Connection List sets up the number of GPs connected to the PLC, registered beforehand on the PLC side. When these GPs are connected to the PLC, the corresponding PLC bit numbers for the particular GP Stations (see bottom) turn on.

- **When the GP is connected to the PLC, and the option of GP only correspondence ends and OFFLINE mode is entered, the GP Station Number**



Note: turns the corresponding PLC bit off.

Bit 15 Bit 0

15	14	13	12	11	10	9	8	7	6	5	4	3	2	1	0
unit	unit	unit	unit	unit	unit	unit	unit	unit	unit	unit	unit	unit	unit	unit	unit

For example, when these 4 GP units—bit 0, bit 2, bit 3, bit 5—are connected, 002D (h) is written here.

Connection List

0	0	0	0	0	0	0	0	0	0	0	0	1	0	1	1	0	1
---	---	---	---	---	---	---	---	---	---	---	---	---	---	---	---	---	---

 002D (h)



- Be certain to set up the GP before running the program.
- Turn bits not connected to the GP off.



Avoid keeping the bits in the list of connected stations OFF for long periods of time even though the GP is connected.

• **Verification List**

This area responds to the correspondence from each connected GP. In the Verification List, when the same bit numbers as the Connection List turn On, the correspondence is accepted. The Station Numbers of the communicating GPs turn their corresponding PLC bit number on.

Bit 15

Bit 0

15	14	13	12	11	10	9	8	7	6	5	4	3	2	1	0
unit	unit	unit	unit	unit	unit	unit	unit	unit	unit	unit	unit	unit	unit	unit	unit

If the correspondence between the GP and PLC is correct, the same value as in the Connection List is written to the Verification List.

For example, the value 002D (h) in the Connection List, set up as the 0 bit, 2 bit, 3 bit, and 5 bit, writes to the Verification List.

ConnectionList

0	0	0	0	0	0	0	0	0	0	0	0	1	0	1	1	0	1
---	---	---	---	---	---	---	---	---	---	---	---	---	---	---	---	---	---

 002D (h)

VerificationList

0	0	0	0	0	0	0	0	0	0	0	0	1	0	1	1	0	1
---	---	---	---	---	---	---	---	---	---	---	---	---	---	---	---	---	---

 002D (h)



Note: When the Connection List and Verification List do not match, a COMMUNICATION ERROR occurs. Check the setup again.



Careful! When changing the type of connection, first turn all the List bits Off.

- **STATION NO.**

This is the setup for the GP Station Number mentioned in the above section. The setup range is from 0 to 15, and the only other restriction is the GP STATION NO. must be unique in the system. If STATION NO.'s are repeated, a COMMUNICATION ERROR occurs.



The STATION NO. is the number allocated to the particular GP unit. This number is not related to the Link I/F Machine number.

< Station Setting Data Example >

The following shows the example of station settings used to connect two (2) GPs by n:1(multi-link) connection.

	GP1	GP2
Station No. ^{*1}	1	1
GP Station No. ^{*2}	0	1
Storage Address ^{*3}	D100	D100

**1 Enter the station numbers of the link unit being connected.*

**2 Be sure that you do not create any duplicate GP station numbers (from 0 to 15).*

**3 All GPs must be set so as to use the same storage address to avoid overlapping System Data Area's settings.*

Writing [3] in [D100] enables the system to start communication after you finished all settings shown above.



4.7 CUSTOMIZE SETUP

The Customize function alters the **n:1** (multi-link) connection's communication to make it more effective. To run communication efficiently, determine whether to use Operation or Display priority with your GP. As a result, the communication response speed can be upgraded. (However, this changes with the screen information.)

When setting the system data area while in the GP's OFFLINE mode, be sure to use the [CUSTOMIZE SETUP], located inside the [INITIALIZE] menu's [SET UP OPERATION SURROUNDINGS] selection screen.

CUSTOMIZE SETUP			SET	CANCEL
PLC PRIORITY	DISPLAY	OPE.		
GP TOUCH MONOPOLIZE	ON	OFF		
MONOPOLIZE TIME	()	* 10 seconds		

(GP-470 Screen)

- **PLC PRIORITY**

According to how the GP is used, select either Operation priority (OPE.) or Display priority.

- **Display**

Set up the GP to this option when using the GP mainly as a monitor screen. The GP will command a higher display speed as a result; however, the response time for the touch panel's operations will slow.

- **Operation**

Set up the GP to this option when using the GP mainly as an operation panel. As a result, the GP will command better touch panel numeric input and switch response times.

Leaving the GP in this mode does not influence the touch panel operation response time of the rest of the GPs very much; however, the screen display renewal cycle will slow down.



- **In a basic setup, run the same setup for all connected GPs.**
- **To increase the display speed, restrict the address setup to consecutive addresses wherever possible. And make bit addresses consecutive to the word unit.**

- **Speed Difference between Display Priority and Operation Priority**

When using the Mitsubishi Electric Corp. A3A PLC, with a scan time of 20ms with consecutive addresses (80 words not included in the System Area), the difference in reading speed is as shown in the following graphs.

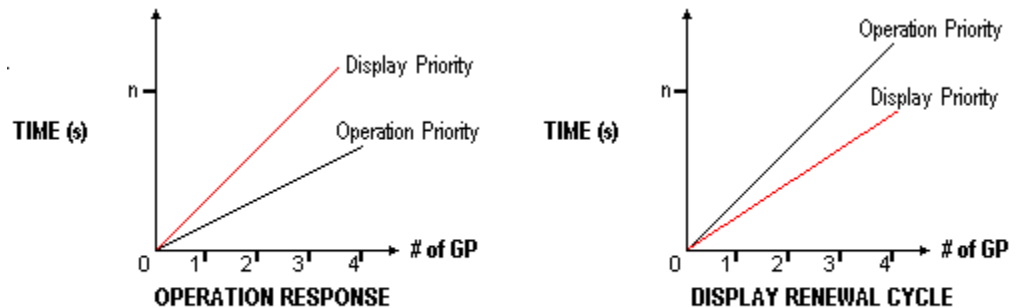

- **GP TOUCH MONOPOLIZE**

The monopolizing of touch panel use can be set ON or OFF. When you want to use the PLC exclusively (**Reference** Chapter 4.5, *About PLC Monopolize*.) with a Momentary operation setup on the touch panel, turn GP TOUCH MONOPOLIZE on.

When this setup is on, the touch panel uses the PLC exclusively whenever the momentary operation setup on the panel is pressed. In this way, you can perform inching operation via a momentary switch. When you stop pressing the panel, exclusive use ends.

- **MONOPOLIZE TIME (0~2550s)**

This field controls the length of time for the monopolize process when no other touch panel operations are performed. The Monopolize process begins when the System Data Area's 7th bit of word address LS14 turns on, and ends either when the bit turns off, or when the time set here passes.



- Pressing the touch panel in the middle of the monopolize process interrupts the MONOPOLIZE TIME function, ending exclusive use.
- When MONOPOLIZE TIME is set to 0, the monopolize function does not end automatically.

Reference For more about the contents of System Data Area LS6 (status) and LS14 (control), refer to Chapter 1.1.4, "Contents and Range of System Area."