

Device/PLC Connection Manuals



About the Device/PLC Connection Manuals



Prior to reading these manuals and setting up your device, be sure to read the "Important: Prior to reading the Device/PLC Connection manual" information. Also, be sure to download the "Preface for Trademark Rights, List of Units Supported, How to Read Manuals and Documentation Conventions" PDF file. Furthermore, be sure to keep all manual-related data in a safe, easy-to-find location.

8.2 Profibus-DP

8.2.1 System Structure for

The following table shows the types of PLCs that can be used with Digitalis GP panel.

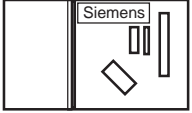
■ SIMATIC S7-300/400 Series

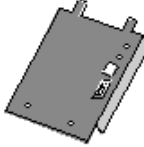
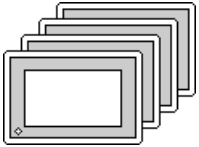
CPU	Cable Diagram	Link I/F	GP
			
S7-300 Series i.e. S7 315-2-DP S7-400 Series i.e. CPU 413-2-D	RS-485 (Cable Diagram 1)	Profibus-DP Module (GP070-PF11)	GP Series *1

*1 Refer to Siemens Connectable Devices.

■ Typical Profibus-DP System Layout

The following diagram shows the standard design of a typical Profibus-DP system.

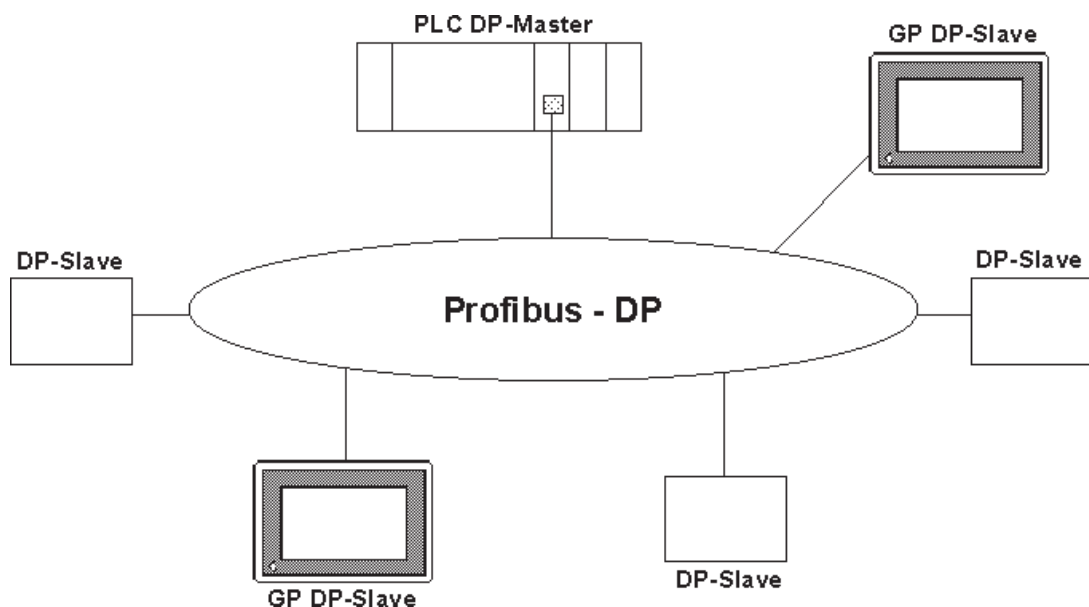

8.2.2 Data Transfer with GP via Profibus-DP

■ Data Transfer Settings

There are two modes of operation for data transfer: Direct I/O and Packet Transfer. These can be selected from the “OFFLINE mode” on the GP. Typical settings for this OFFLINE screen are shown below.

■ From the initial OFFLINE menu screen:

- 1) Select [INITIALIZE] to call up the initial settings screen.
- 2) Select the [SET UP OPERATION SURROUNDINGS] menu item (screen below appears).
- 3) Configure the environment settings to suit your particular requirements. (Ex. Direct I/O, Input/Output Area Size, etc.)



Use PRO-PBIII to set the System Area's start address. This cannot be set with the GP's OFFLINE mode.

```

SET UP OPERATION SURROUNDINGS

SYSTEM DATA AREA  START DATA BLOCK [  0010  ]

                        START DATA WORD [  000  ]

SYSTEM AREA READING AREA SIZE (0 - 256) [  0  ]

COMMUNICATION DATA TYPE                DIRECT I/O PACKET

DIRECT I/O START ADDRESS                  [ LS0020  ]

                        INPUT AREA SIZE    [  16  ]

                        OUTPUT AREA SIZE   [  16  ]

```

■ Direct I/O

The GP can communicate with a master PLC in a very simple manner using the “Direct I/O” configuration. With this method, an area of memory is mapped from the GP’s LS area into the PLC’s input area and an area of the PLC’s output is mapped into the GP’s LS area. Set the start address of the direct I/O where you would like the GP’s internal memory to be mapped from, e.g. LS20. Set the Input and Output area sizes (in words) as required (max. 64 words). These are the sizes of the areas which will be mapped to and from the PLC and are shown below as shaded areas.



Input and output sizes must match those set up in the designated hardware configuration.

Reference this section's ■ "Configuring the GP as a Profibus-DP Slave"

This concept is illustrated below. The GP Slave Input and Output start addresses, EW40 and AW20, have been configured using the PLC programming device (for other PLC types, see relevant documentation on how to configure Input and Output addresses).

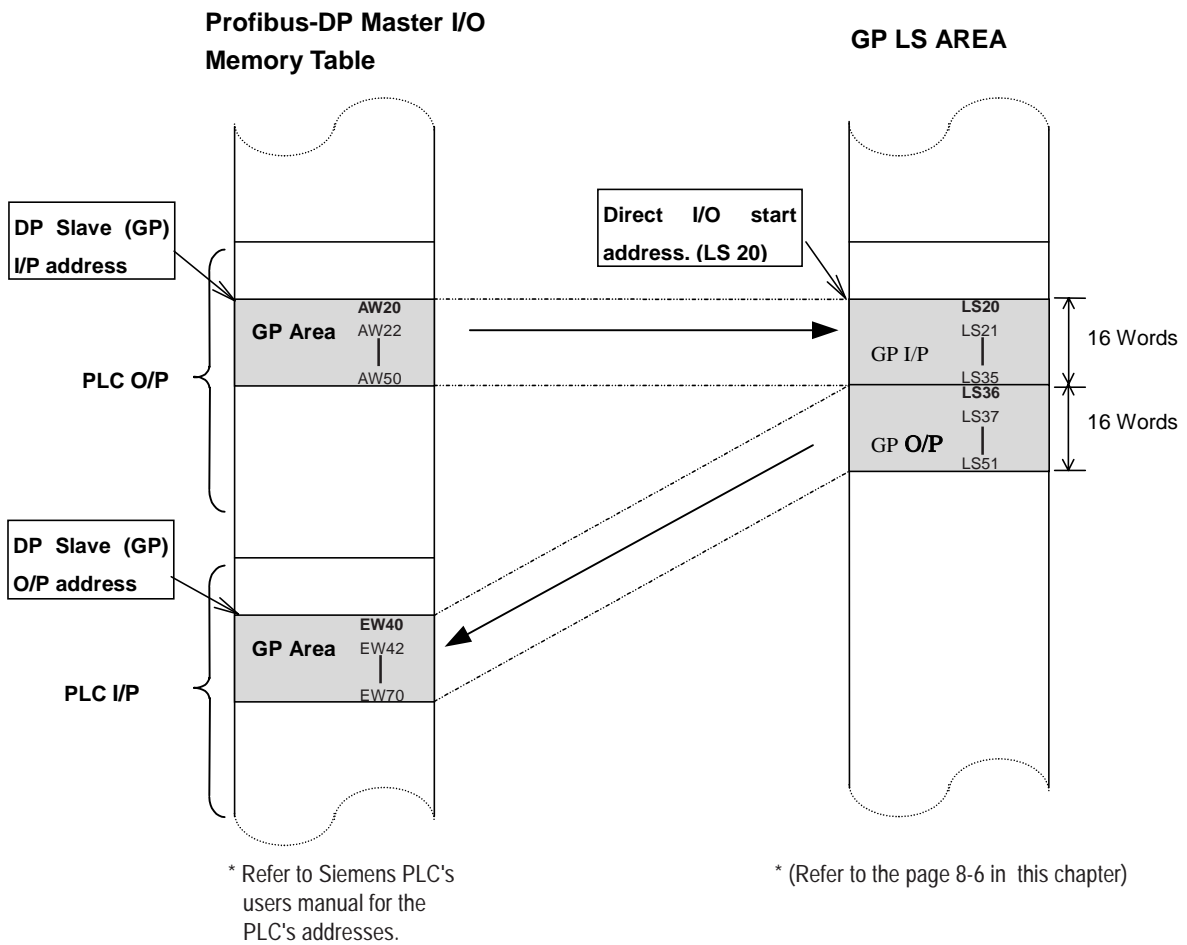

■ **Packet Transfer**

This option gives the user greater flexibility than the Direct I/O option, allowing him to read a wider range of devices. This flexibility is the result of using an interpreter program, run on the PLC, in addition to the User's own PLC program(s). For information about these items, refer to the "README.TXT" file in the " FIELDBUS" folder on the GP-PRO/PB III for Windows Ver.5.0 CD-ROM.

■ GP Packet Transfer Environment Settings

The following settings are needed to allow the GP to function in the packet transfer mode:

- 1) Use the OFFLINE screen's SETUP OPERATION SURROUNDINGS area to choose the "PACKET" communication option.
Reference "8.2.2 Data Transfer with GP via Profibus-DP"
- 2) Set this area's INPUT AREA SIZE and OUTPUT AREA SIZE settings to "0".



If the INPUT and OUTPUT AREA values are not set to "0", packet transfer cannot be performed.

■ PLC (Master) Packet Transfer Environment Settings

The Profibus interface unit must be configured as an input and output device, and both the input and output areas need to be allocated 16 bytes of PLC memory.

■ "Configuring the GP as a Profibus-DP Slave" and "Installation of Interpreter Project"

For information about these items, refer to the "README.TXT" file in the "FIELDBUS" folder on the GP-PRO/PB III for Windows Ver.5.0 CD-ROM.

8.2.3 Cable Diagram

The following cable diagram should be used when making a cable for the Profibus-DP cable's connector.

Cable Diagram 1 RS-485

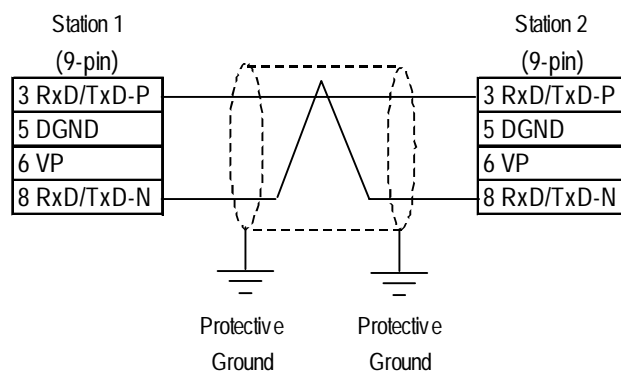

8.2.4 Supported Devices

■ Profibus-DP (for Direct I/O)

The range of devices supported by the GP is shown below.

Device	Bit Addresses	Word Addresses
LS	LS00200 - LS1999F	LS0020 - LS1999



- The User must confirm that sufficient memory is available for the Input and Output areas. For example, if the User chooses 32 words I/P and 32 words O/P, the maximum value for the Direct I/O start address is LS1935.
- The System Area function is NOT available in DIO mode.

■ SIMATIC S7-300/400 Series (for Packet Transfer)

 Setup System Area here.

Device	Bit Address	Word Address	Note
Data register		DB2W0000 - DB60W65534	*1, *2
Input relay	I000000- I655357	IW00000- IW65534	*3, *4
Output relay	O000000 - O655357	OW00000 - OW65534	*3
Internal memory	M00000 - M655357	MW00000 - MW65534	*3

*1 The data range used for the Data Register must be set up in the PLC by the User. Please confirm that all data addresses referenced actually exist (are valid).

*2 The S7 Data Register uses the following Byte Addressing method:

E.g. DB2W 50

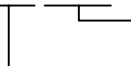
 Represents data Word 50. Values 0 to 65534 are valid. (even addressing only)

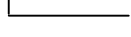
 Represents data Block 2. Values DB2W - DB60W are valid.

*3 The Bit Device illustration is as follows:

E.g,

GP Inscription	PLC Inscription
I0007	I0.7

*4 The Input relay device cannot be written from the GP.



- Failure to configure the Profibus unit correctly can result in inconsistent GP operation on the Profibus network.
- This protocol is intended to be used as a generic protocol for all Profibus PLC's. As a result, the ranges and devices stated here are not intended for any single PLC maker. The user should be sure to check that all values used are those required for their specific PLC.

Environment Setup Cautions

- The user must be sure to use the normal Profibus configuration software to configure the GP unit for use on the Profibus network. Also, the User must ensure that all devices and addresses designated actually exist, otherwise the User's PLC may stop.
- When using the Siemens S7 family of PLCs, the system area start address must be set via the editor software.
- The user must be sure that the System Area's start address is set so that sufficient memory is available for all the System Area used. For example, if 10 words of system area are used, the maximum start area address would be 65524.



Use PRO-PBIII to set the System Area's start address. This cannot be set with the GP's OFFLINE mode.

8.2.5 Environment Setup

■ GP Data Transfer Settings

		GP Settings	
Data Transfer Speed		9.6K to 12Mbps *1	
Data Transfer Method	RS-485		
System Area Start Address		DB2W0	DB60W65514
Station No. *2		0	127

 : Default Settings

*1 The data transfer speed is automatically changed, according to the ladder software's specifications. Thus, setting this speed via the GP is not necessary.

*2 Station No.s are set via the Profibus Rotary Switches.

■ Data Transfer Setup Checklist

The following items should be confirmed prior to transferring data on the Profibus network.

- 1) Be sure that all the installation procedures have been followed.
- 2) Be sure the Profibus unit's two rotary switches are set correctly and, if required, a terminating resistor is used.
- 3) If necessary, be sure the default hardware configuration provided on the Installation disk has been modified correctly.
- 4) Be sure to use the GP's OFFLINE Mode screens to designate the correct options for either a Packet Transfer or Direct I/O configuration. (Use the steps shown below to call up this screen)

From the initial OFFLINE menu screen:

- 1) Select [INITIALIZE] to call up the initial settings screen.
- 2) Select the [SET UP OPERATION SURROUNDINGS] menu item (next screen appears).
- 3) Configure the environment settings to suit your particular requirements. (Ex. Direct I/O, Input/Output Area Size, etc.)

■ "Configuring the GP as a Profibus-DP Slave" and "Installation of Interpreter Project"

For information about these items, refer to the "README.TXT" file in the "FIELD BUS" folder on the GP-PRO/PB III for Windows Ver5.0 CD-ROM.

8.2.6 Error Codes

If the error code “PLC COM. ERROR (02:F6)” appears on the screen after data has been downloaded from the User’s PC to the GP unit, one of the following problems may have occurred.

- 1) The User has configured the GP to operate in Direct I/O mode, and is now trying to reference devices other than those designated in LS memory.
- 2) The User is running the GP in Direct I/O mode, and the system memory area has not been cleared. (Set to “0”)

Error Code	How to Correct
PLC COM Error 02:F6 ^{*1}	1) Be sure that your screen data uses only the designated LS area(s). 2) Reset the System Area (to all zeroes).

**1 For information about other types of error messages, refer to the Operation manual’s error message appendix.*



If the data transmission cable is accidentally cut or disconnected for a long period of time, a system error will occur, which will cause the system to hangup. (Error Codes: 005:02D:010 or 008:02D:010)

