

# Device/PLC Connection Manuals

---



## About the Device/PLC Connection Manuals

Prior to reading these manuals and setting up your device, be sure to read the "Important: Prior to reading the Device/PLC Connection manual" information. Also, be sure to download the "Preface for Trademark Rights, List of Units Supported, How to Read Manuals and Documentation Conventions" PDF file. Furthermore, be sure to keep all manual-related data in a safe, easy-to-find location.



# 5.4 Matsushita Electric Works

## 5.4.1 System Structure

The following describes the system structure for connecting the GP to Matsushita Electric PLCs.

**Reference** The Cable Diagrams mentioned in the following tables are listed in the section titled "5.4.2 Cable Diagrams".

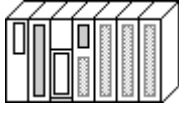
### MEWNET Series (using CPU unit Link I/F)

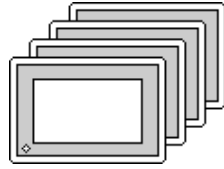
CPU	Cable Diagram	GP
		
FP10S (Ver 1.8+) <sup>*1</sup> FP10SH	(Cable Diagram 1)	GP Series

\*1 Connect to COM port.

An RS-232C/422 adapter is necessary (see below) for connections. Use the RS-232C/422 adapter's 422 side as the terminal, and power other than from the communication line, obtained externally.

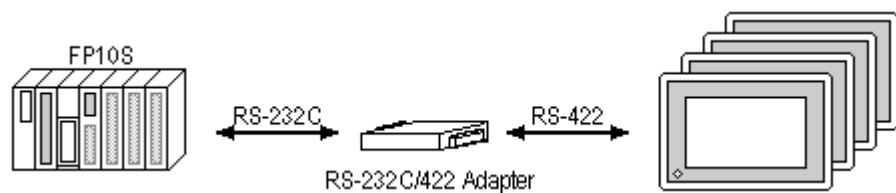

**5.4.2 Cable Diagrams**

The cable diagrams illustrated below and the cable diagrams recommended by Matsushita Electric may differ, however, using these cables for your PLC operations will not cause any problems.

**Cable Diagram 1**

- When using Digital's RS-422 connector terminal adapter GP070-CN10-O

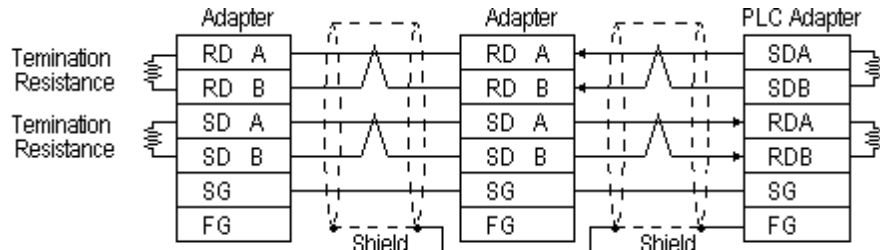

\* Check the PLC Adapter specifications for the Termination Resistance

- When using Digital's Multi-link Cable, GP230-IS12-O

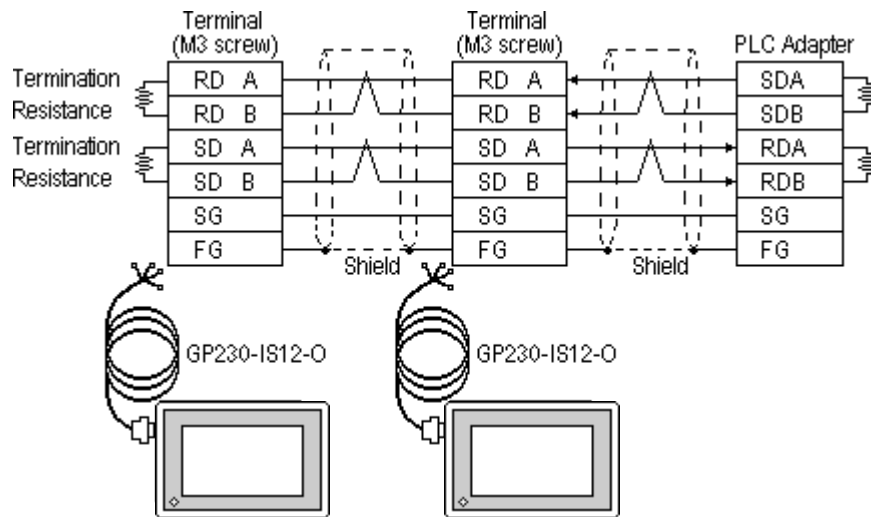

\* Check the PLC Adapter specifications for the Termination Resistance



*Ground your PLC's FG terminal according to your country's applicable standard. For details, refer to the corresponding PLC manual.*



- **Pull out a small amount of the Transfer Cable's shield, make a wire out of it and connect it to the PLC's FG terminal.**
- **The GP230-IS12-O Cable FG terminal is not connected to the GP's FG.**
- **Be aware the A and B signals of the GP and PLC are opposite to each other.**
- **Place a Termination Resistor at both ends of the cable.**
- **As a general rule, connect the PLC on one end of the circuit.**

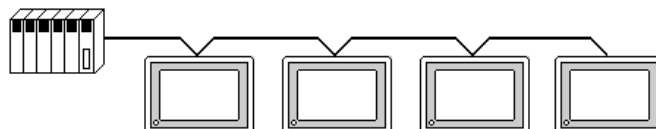



- When making your own connections, Hitachi Densen's CO-SPEV-SB(A)3P\*0.5 cable is recommended.

The cable connection lines are as illustrated below. The cables between the GP and the terminals should be less than 10m.

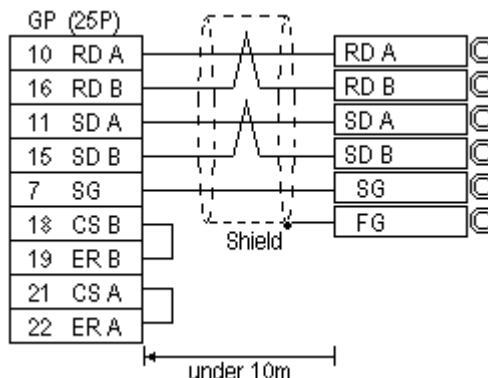

### 5.4.3 Supported Devices

The following describes the range of devices supported by the GP.

#### MEWNET Series

Setup System Area here.

Device	Bit Address	Word Address	Particulars
Input Relay	X0000 ~ X511F	WX000 ~ WX511	*1
Output Relay	Y0000 ~ Y511F	WY000 ~ WY511	
Internal Relay	R0000 ~ R886F	WR000 ~ WR886	
Link Relay	L000 ~ L639F	WL000 ~ WL639	
Special Relay	R9000 ~ R910F	WR900 ~ WR910	*1
Timer (contact)	T0000 ~ T3071	---	*1
Counter (contact)	C0000 ~ C3071	---	*1
Timer/Counter (elapsed time)	---	EV0000 ~ EV3071	*1
Timer/Counter (setup value)	---	SV0000 ~ SV3071	*1
Data Register	---	DT0000 ~ DT10239	<span style="border: 1px solid black; padding: 2px;">Bit 15</span> *2
Link Register	---	Ld0000 ~ Ld8447	<span style="border: 1px solid black; padding: 2px;">Bit 15</span>
File Register	---	FL00000 ~ FL32764	<span style="border: 1px solid black; padding: 2px;">Bit 15</span>
Special Data Register	---	DT90000~DT90511	<span style="border: 1px solid black; padding: 2px;">Bit 15</span> *3

\*1 Cannot perform data write.

\*2 Some CPU types use this device's word address DT09000 and higher as the Special Data Register.

\*3 Only the FP10SH, FP10S, FP10 and FP2 can use this device.

### 5.4.4 Environment Setup

The following lists Digital's recommended PLC and GP communication settings.

#### ■ FP10S/FP10SH

GP Setup		COM Port Setup	
Baud Rate	19200 bps	Baud Rate	19200 bps
Data Length	8 bits	Data Length	8 bits
Stop Bit	1 bit	Stop Bit	1 bit
Parity Bit	Odd	Parity Bit	Odd
Data Flow Control	ER Control		
Communication Format	4-wire type		
		Environ Task Allowable Time Setup	K5000
Unit No.	1	Unit No.	1