

PL-SM900 Software Mirroring Utility User Manual

Preface

Thank you for purchasing Pro-face's PL-SM900 Software Mirroring Utility, hereafter referred to as the "PL-SM900".

Prior to using the PL-SM900, please be sure to read this manual thoroughly to understand the correct and safe usage of this product and its features.

<Note>

- 1) It is forbidden to copy the contents of this manual, in whole or in part, except for the user's personal use, without the express permission of Digital Electronics Corporation of Japan.
- 2) The information provided in this manual is subject to change without notice.
- 3) This manual has been written with care and attention to detail; however, should you find any errors or omissions, please contact Digital Electronics Corporation and inform us of your findings.
- 4) Digital Electronics Corporation shall not be held responsible for any damages, losses or third-party damages resulting from the use of this product.

All Company/Manufacturer names used in this manual are the registered trademarks of those companies.





© 2004 Digital Electronics Corporation

Table of Contents

Preface	1
Table of Contents	2
Documentation Conventions	3
Package Contents	3
CD-ROM Contents	4
Usage Environment	5
Prior to Installing the PL-SM900	
in a PL Series unit running Windows® 2000	6
Connecting a USB Device using Windows® 2000	6
1 Software Mirroring Disk Utility	7
1.1 Software Mirroring Disk Utility Features	7
1.2 Software Design	7
2 Mirroring Disk Setup	8
2.1 Master Drive Preparation	8
2.2 Software Mirroring Utility Installation	9
2.3 Software Mirroring Driver Installation	9
2.4 Slave Drive Preparation	17
2.5 Software Mirroring Disk Preparation	18
3 Software Mirroring Disk Operation	19
4 Error Messages	24

Documentation Conventions

The list below describes the documentation conventions used in this manual.

 WARNING	Indicates situations where severe bodily injury, death or major equipment damage can occur.
 CAUTION	Indicates situations where bodily injury or machine damage can occur.
*1	Indicates words and phrases explained in footnotes.
 important	Indicates important information or procedures that must be followed to prevent Software Mirroring operation or data-related problems
 Note:	Provides useful or important supplemental information.
 Reference	Indicates a page or material containing reference information.
1., 2., ...	Indicates steps in a procedure. Be sure to perform these steps in the order given.

Package Contents

The Software Mirroring unit's packing box contains the items listed below. Please check to confirm that all items shown below have been included.

■ CD-ROM (1)

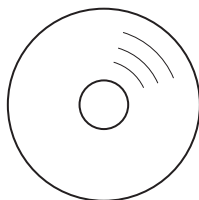

■ Software Mirroring (1)
Installation Guide

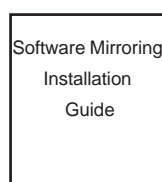

This unit has been carefully packed with special attention to quality. However, should you find anything damaged or missing, please contact your local distributor immediately.

CD-ROM Contents

The Software Mirroring unit's CD-ROM data is organized as follows.

PL-SM900 CD-ROM

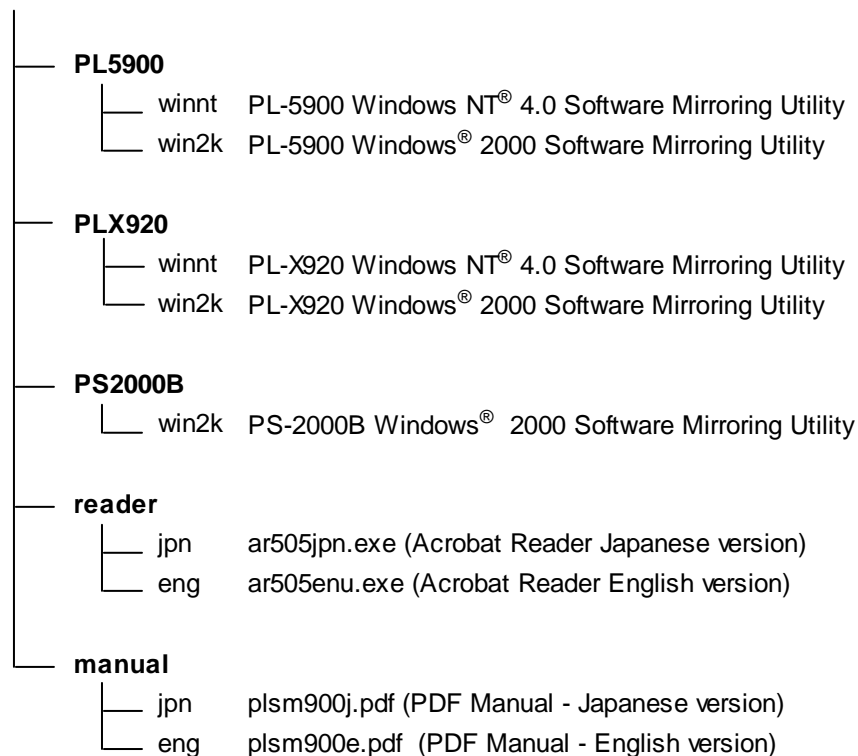

Usage Environment

The Software Mirroring utility is designed to be used with the following equipment.

Item Name	PL-5900	PL-X920	PS-2000B
HDD Unit	Requires 2 PL-HD220 units		Requires 2 PSB-HD020 units
OS	Windows NT [®] Workstation 4.0 SP6a or Windows [®] 2000 Professional		Windows [®] 2000 Professional

While the Software Mirroring utility is designed to be used with the entire Pro-face line of PL-X920 Series models, it is designed to work with only the PL-5900 Series' 3-slot type PL-5900. It cannot be used with the PL-5901 (1 slot type).



- **Windows[®] 2000's Dynamic Disk feature is not supported.**
- **The Software mirroring utility has no problems operating, even if the file format used is NTFS.**
- **Data transfer mode only operates in PIO mode.**
When the software mirroring utility is installed, the data transfer mode is automatically changed to PIO mode.
- **To extend the operating life of the PL unit's hard disk, Pro-face recommends you use one of the following procedures to turn the hard disk OFF when the unit is not being operated.**
 - **When running Windows[®] 2000**
Set the Windows [Control Panel] - [Power Options] - [Power Schemes] tab's [Turn off hard disks:] selection. Pro-face recommends a setting of [After 5 mins].
 - **When running Windows NT[®]**
Set the [System Monitor Property] menu [Mirror] tab's [Turn off Hard Disk] selection. This setting is enabled only if the System Monitor is running.

Prior to Installing the PL-SM900 in a PL Series unit running Windows® 2000

When Installing the Software Mirroring Utility (PL-SM900) in a PL Series unit running Windows® 2000, it is possible that an error message will appear and Windows® will not be able to start. To prevent this problem, be sure to perform the following procedure PRIOR to installing the Software Mirroring Utility.

When using a PL/PS series unit equipped with a preinstalled hard disk, installing the Mirror Disk Utility will automatically upgrade the MSGINA.DLL file to the new version, and the following steps are not required.

1. Check if the MSGINA.DLL file's version is 5.0.2195.4733

The MSGINA.DLL file is found in the C:\Winnt\System32 folder. Only if your PL unit's MSGINA.DLL file version is 5.0.2195.4733 do you need to install the update module. If your version of this file is not 5.0.2195.4733, you can now install your Software Mirroring Utility.

2. Download the update module.

Download the Windows® 2000 version update module from the following site.
<http://support.microsoft.com/default.aspx?scid=kb;en-us;328310>

3. Install the downloaded file.

Double-click on the following file's icon or use the "Run" feature to start the installation process.

Q328310_W2K_SP4_X86_EN.exe

Follow the instructions given to install the new file. This will install the new version of MSGINA.DLL in your C:\Winnt\System32 folder. the new version of MSGINA.DLL is 5.0.2195.6090.

After completing the installation, restart your PL unit.

4. Install the Software Mirroring Utility.

Follow the installation instructions given in this manual.

Connecting a USB Device using Windows® 2000

When using Windows® 2000, be sure to disconnect all USB devices prior to starting Windows®. If any USB devices are connected, the OS will freeze (hang up). As a result, the Software Mirroring Utility status will change to "Reduced", and mirroring rebuild will be required.

1 Software Mirroring Disk Utility

1.1 Software Mirroring Disk Utility Features

RAID (Redundant Array of Independent Disks) is a multiple hard disk management system that allows high speed access and redundancy of user data to increase user system reliability and protect from data loss in the case of a hard disk failure.

Five levels of RAID are available - RAID0, RAID1, RAID3, RAID4, and RAID5, as well as combinations, such as RAID0+1.

The Software Mirroring Disk Utility uses the RAID1 system.

With a RAID1 system, two HDD units are used and data is saved simultaneously to both units. This provides a high level of system reliability.

However, since this system considers both HDD drives to be a single unit, the data capacity of the system is equal to only one of the drives. For example, if both drives are 6GB drives, the total system capacity is 6GB, not 12GB.

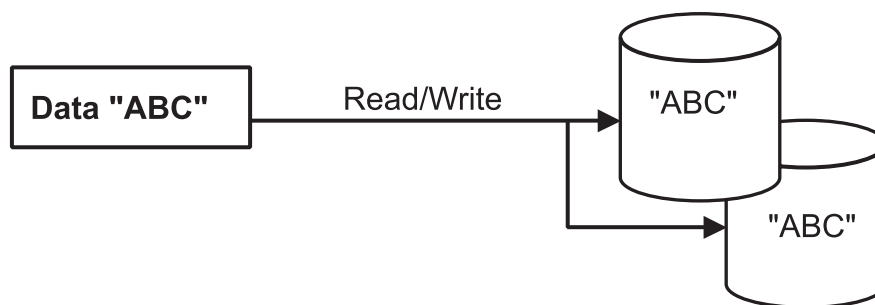

The end result is that two physically separate HDD drives operate like a single drive.

1.2 Software Design

To use the Software Mirroring Disk utility, the following software is required.

- Software Mirroring Disk Driver

Your PL or PS-B unit's system (OS) requires that, in order to write data to both drives (same size), and to detect HDD errors that occur during the data write process, this utility reports those errors to the Mirroring Disk Utility.

- Software Mirroring Disk Utility

This program monitors the condition of the Mirroring Disk Driver, and reports errors to the user. This utility also includes the feature of combining two (same size) HDD units into a single Mirroring disk.

2 Mirroring Disk Setup

This section explains the preparation of the Master drive, the installation of the Software Mirroring Utility software and the installation of the HDD drives.

⚠ WARNINGS

To prevent an electrical shock, prior to installing the HDD units in the PL or PS-B, be sure the PL or PS-B unit's power cord is disconnected and the main power supply is turned OFF.

2.1 Master Drive Preparation

■ Setting the Master Drive Jumper Plug

This explanation explains how to change the PL unit's optional HDD drive from "Slave" to "Master".

Normally, the PL or PS-B unit's factory installed HDD unit is set to be the PL or PS-B unit's Master drive.

This explanation assumes the optional PL-HD220 or PSB-HD020 unit will be used as the Master drive, in which case the unit's jumper plug will need to be removed to change the drive's setting from Slave to Master. (see below)

Front (connector) face of PL-HD220 unit

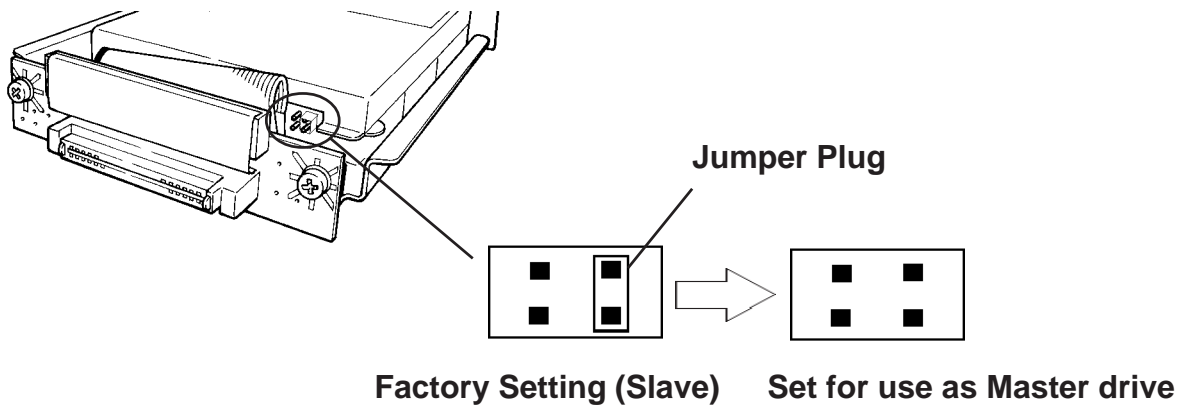

■ Designate the Master drive in your PL or PS-B unit's OS.

Reference

Refer to one of the following manuals:

PL-5900 Series User Manual - Chapter 6 OS Setup

PL-X920 Series User Manual - Chapter 6 Setting Up Your PL OS

PS-2000B Series User Manual - Chapter 6 SETTING UP YOUR PS-B UNIT

2.2 Software Mirroring Utility Installation

Next, install the Software Mirror Disk Utility (SMmon) in your PL or PS-B unit's master drive. Click on your CD-ROM drive's setup.exe file icon to start the Software Mirror Disk Utility installation. The software used will depend on your type of PL or PS-B unit. **Reference** *CD-ROM Contents*

- PL-5900: "PL5900" folder's "setup.exe" icon
- PL-X920: "PLX920" folder's "setup.exe" icon
- PS-2000B: "PS2000B" folder's "setup.exe" icon



If the "Intel Ultra ATA Storage Driver" or "Intel Application Accelerator" is installed on your PC (PL-X920 or PS-2000B), it must be uninstalled. Click [OK] to remove this driver.



Ex.) With the "Intel Ultra ATA Storage Driver"

2.3 Software Mirroring Driver Installation

■ Confirming the System Information Settings

This section explains how to confirm your PL unit's system information settings.

With a PL-5900:

Change the following parameters in your PL unit's "Advanced BIOS Features" area.

- First Boot Device : Floppy
- Second Boot Device : HDD-0
- Third Boot Device : CDROM

With a PL-X920/PS-2000B:

Change the following parameters in your PL or PS-B unit's "Advanced BIOS Features" area.

- First Boot Device : Floppy
- Second Boot Device : HDD-0
- Third Boot Device : CDROM
- Fourth Boot Device : Disabled



PL-5900 Series User Manual 5.2 System Parameters

PL-X920 Series User Manual 5-2 System Parameters

PS-2000B Series User Manual 3.2 System Parameters

■ Installing the Software Mirroring Driver



Note: If you install this utility from a CD-ROM, use Pro-face's optional PL-DK200 or PSB-CD/FD01.

Reference *PL-DK200 Installation Guide or PSB-CD/FD01 Installation Guide*

With the Windows NT® 4.0 OS

1. Double click on the Control Panel's SCSI Adapter icon.

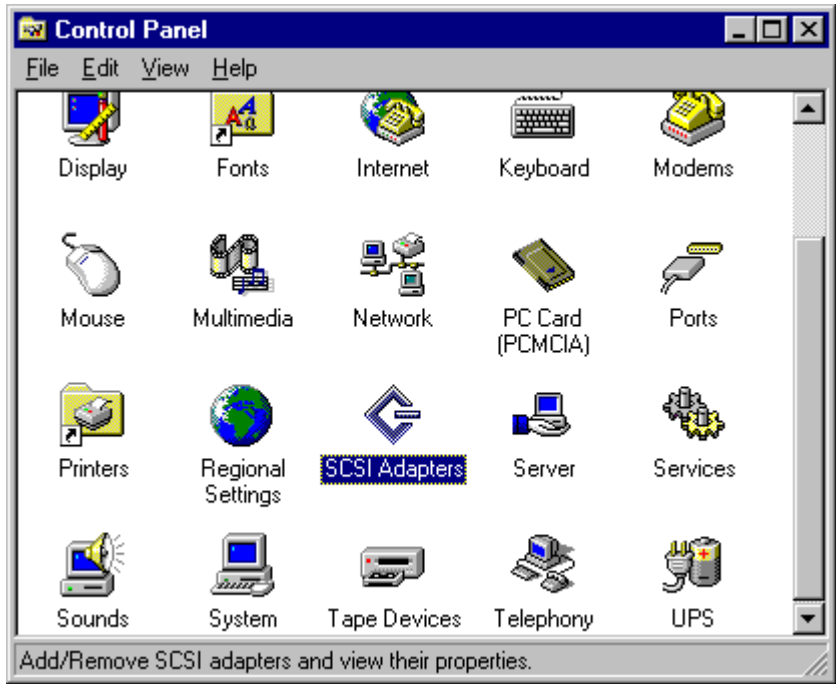

2. Click on the [SCSI Adapter] dialog box's [Driver] tab. In the screen that appears, click on the "IDE CD-ROM(ATAPI 1.2/Dual-channel PCI" selection, and then click on the [Remove] button.

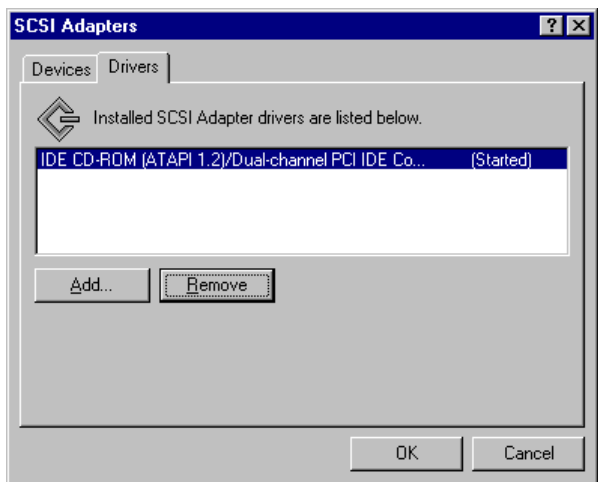

3. In the "Remove Driver" dialog box, click on [Yes].



- Click on the [Add] button, and a list of available drivers will be created.

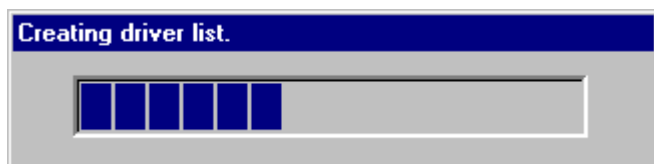
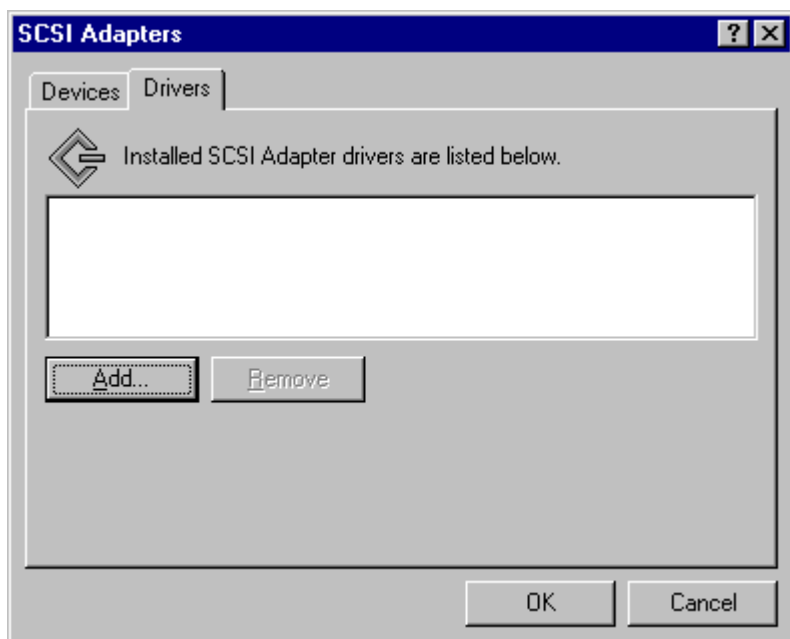

- Click on the [Have Disk] button.

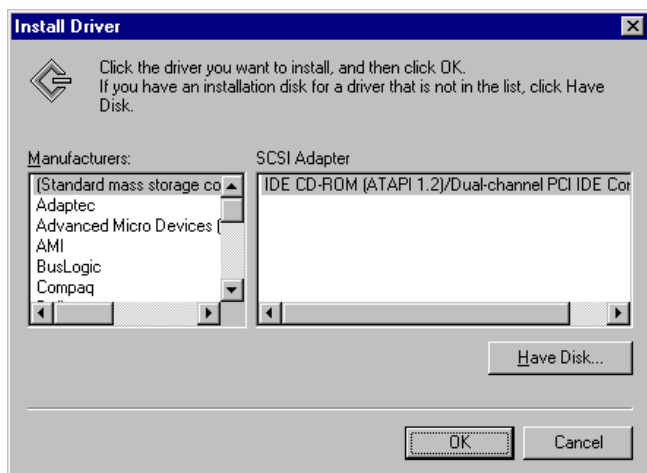

Chapter 2 - Mirroring Disk Configuration

6. In the "Copy manufacturer's files from: " text entry box, enter one of the following file paths and click on the [OK] button.

Assuming the CD-ROM drive is the "D" drive:

for a PL-5900 Series unit - "d:\PL5900\winnt"

for a PL-X920 Series unit - "d:\PLX920\winnt"

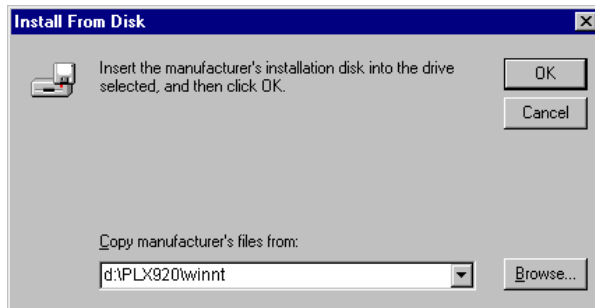

7. After confirming that the "Digital SoftMirror IDE Driver" has been installed, click on the [OK] button.

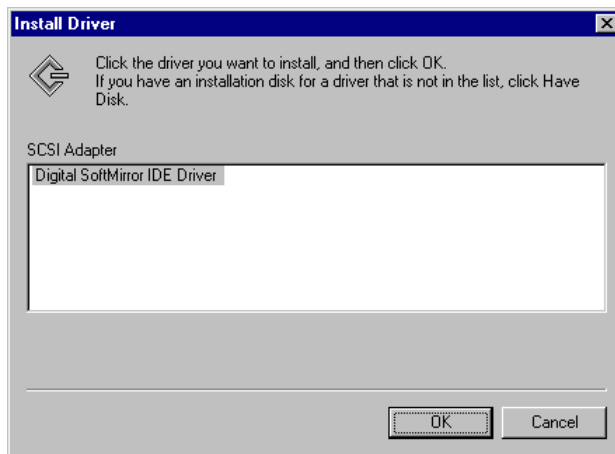

8. In the "System Settings Change" dialog box, click on the [Yes] button to restart the PL unit.

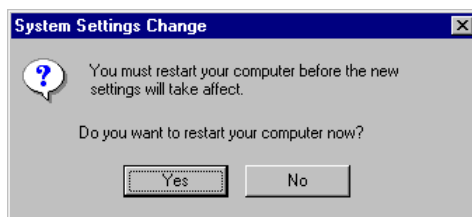

With the Windows® 2000 OS

1. Double click on the Control Panel's [System] icon.



2. Click on the [System Properties] dialog box's [Hardware] tab, and then click on the [Device Manager] button.

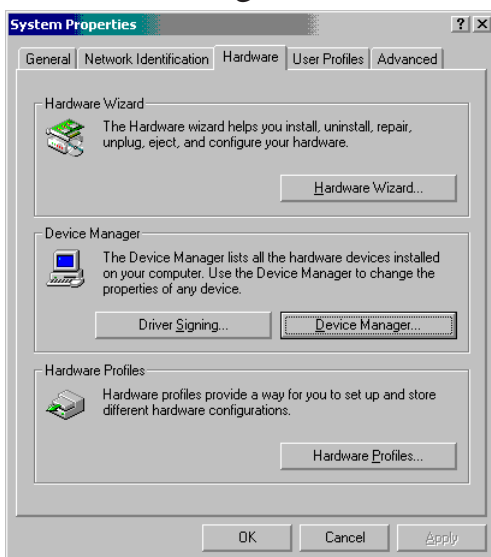

3. In the [Device Manager] window, click on the [IDE ATA/ATAPI Controllers] icon, then on the [SiS PCIIDE Controller] or [Intel(r) 82801BA Bus Master IDE Controller] and then press your keyboard's [Enter] key.

PL-5900 Series unit: [SiS PCIIDE Controller]

PL-X920 Series unit: [Intel(r) 82801BA Bus Master IDE Controller] or
[Intel(r) 82801BA Ultra Storage Controller-244B]

PS-2000B Series unit: [Intel(r) 82801BA Bus Master IDE Controller] or
[Intel(r) 82801BA Ultra Storage Controller-244B]

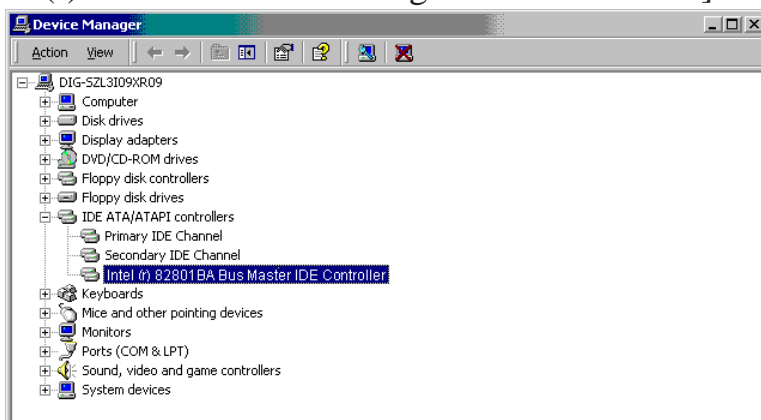

Chapter 2 - Mirroring Disk Configuration

4. In the [SiS PCIIDE Controller Properties], [Intel(r) 82801BA Bus Master IDE Controller Properties] or [Intel(r) 82801BA Ultra Storage Controller-244B] area's [Driver] tab, click on the [Locate Driver] button.

PL-5900 Series unit: [SiS PCIIDE Controller Properties]

PL-X920 Series unit: [Intel(r) 82801BA Bus Master IDE Controller] or [Intel(r) 82801BA Ultra Storage Controller-244B]

PS-2000B Series unit: [Intel(r) 82801BA Bus Master IDE Controller] or [Intel(r) 82801BA Ultra Storage Controller-244B]



5. After the "Upgrade Device Driver Wizard" starts up, click on the [Next] button.



6. Click on the [Search for suitable driver for my device (recommended)] selection, and then on the [Next] button.

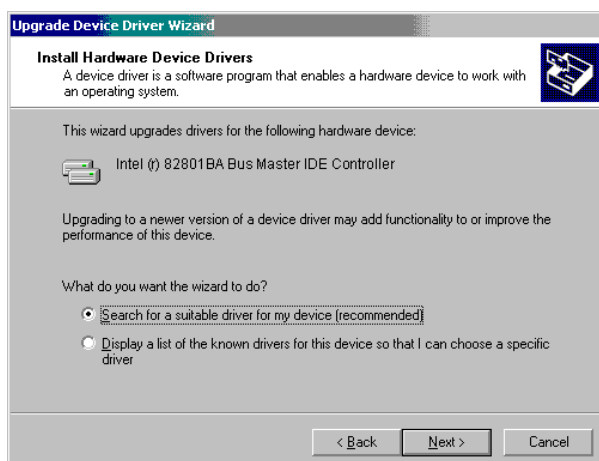

7. Click on the [Specify a location] box, and then on the [Next] button.

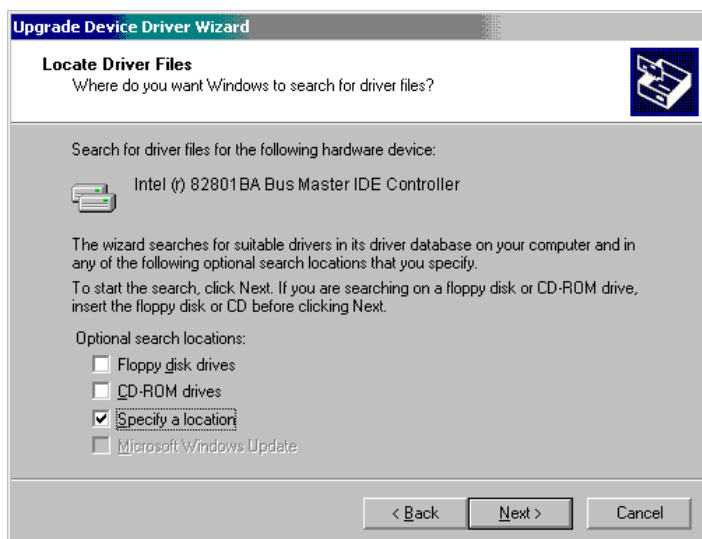

8. In the [Upgrade Device Driver Wizard] area's "Copy manufacturer's files from:" text entry box, enter one of the following file paths and click on the [OK] button.

Assuming the CD-ROM drive is the "D" drive:

for a PL-5900 Series unit - "d:\5900\win2k"

for a PL-X900 Series unit - "d:\PLX920\win2k"

for a PS-2000B Series unit - "d:\PS2000B\win2k"



9. In the following window, click on the [Install one of the other drivers] box, and then on the [Next] button.

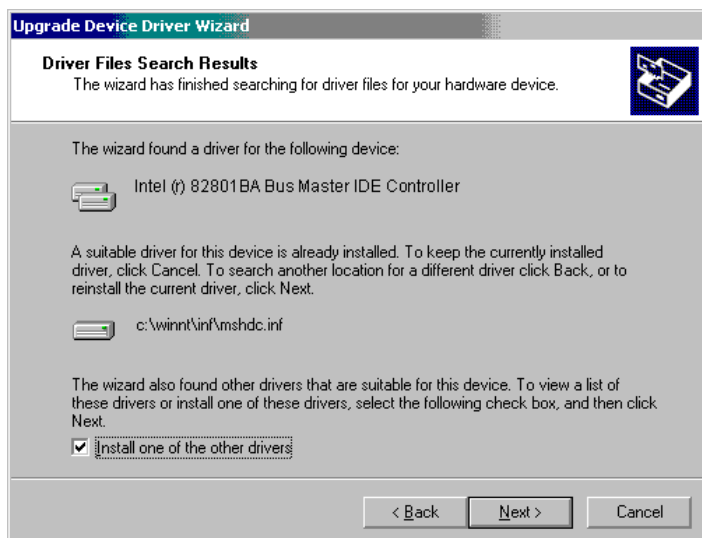

10. Click on the [Digital SoftMirror IDE Driver] to select it and then on the [Next] button.

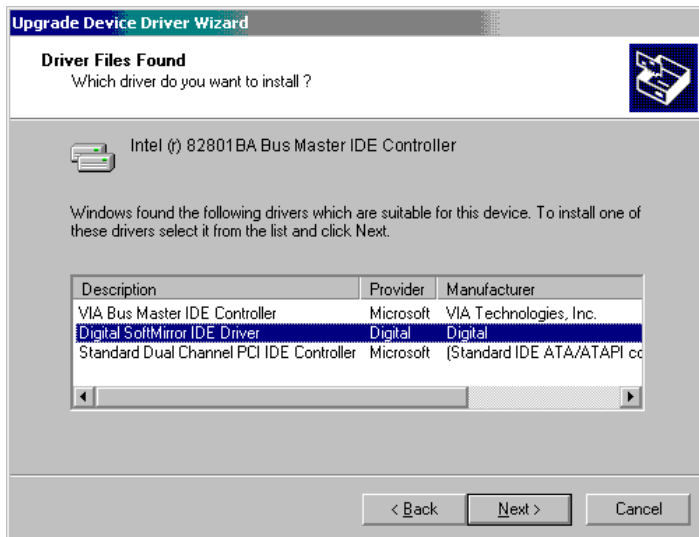

11. In the [Digital Signature Not Found] screen, click on the [Yes] button.

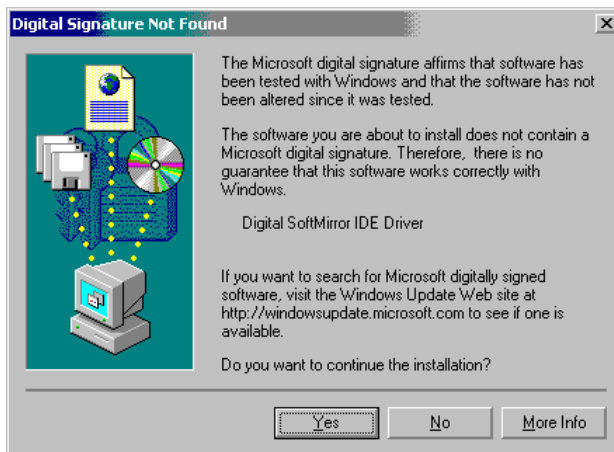

12. In the following screen, click on the [Finish] button and the PL or PS-B will restart. After the PL or PS-B restarts, if the [Found new device] dialog box appears, restart the PL or PS-B again.



2.4 Slave Drive Preparation

This section explains how to insert the PL unit's optional HDD drive (PL-HD220, PSB-HD020) into a PL or PS-B unit.

Confirm that the HDD unit is set to be the Slave drive.

Reference *"PL-HD220 Installation Guide", "PSB-HD020 Installation Guide"*

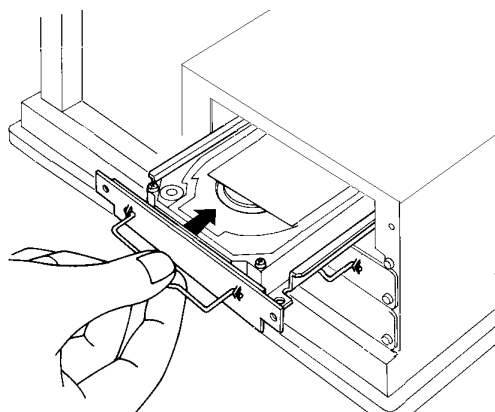

Ex. PL-6920 unit

2.5 Software Mirroring Disk Preparation

■ Starting the Software Mirroring Disk Utility

Start the Mirroring Disk Utility. To do this, click on the [Start] -> [Program(P)] -> [Soft Mirror Disk Utility] -> [SMmon] selection.

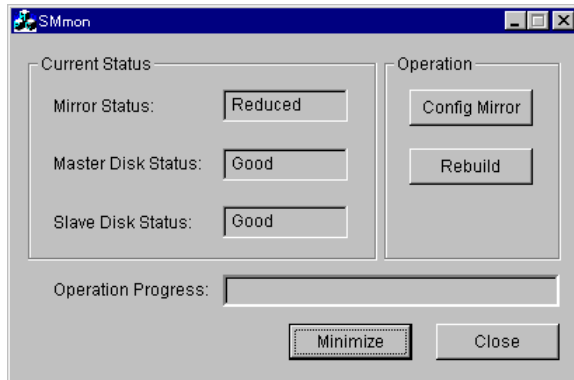

■ Configuring the Mirroring Disk

To configure the Mirror Disk, click on the [Config Mirror] button.

The Mirroring Disk driver will now write the control settings to the HDD. All disk access will be performed through the Mirroring Disk driver.

After the Mirroring Disk is configured, a confirmation screen will appear. Click on the [OK] button.

■ Rebuilding the Mirroring Disk

After the Mirroring Disk configuration is finished, the [Rebuild] feature is used. Click on the [Rebuild] button.

This will start the copying from the first HDD to the second HDD. The Rebuild process takes approximately 3 hours to complete. If desired, the HDD can be accessed during the rebuild process, however, performance will be slower than normal.

When the rebuild is finished, a confirmation screen will appear. Click on the [OK] button.

■ Using the Mirroring Disk Feature

After the rebuild process is finished, the Mirroring Disk feature will begin to operate.

3 Software Mirroring Disk Operation

After the Mirroring Disk Rebuild finishes, assuming there are no Master or Slave drive errors, mirroring will be performed normally.

You can use the Mirroring Disk Utility to check the condition of the Mirroring Disk, Master Drive and Slave Drive.



Do not perform the following operations. Performing them could damage the Software Mirroring Disk.

- Do not exchange the HDD in your PL or PS-B for the software mirroring HDD used in another PL or PS-B unit.
- Do not use a non-Windows operating system to run the PL or PS-B or to write data to the HDD unit.
- After configuring the Mirroring Disk, do not change the previously entered Boot Sequence and Boot Device settings.

■ Drive Condition Detailed Information

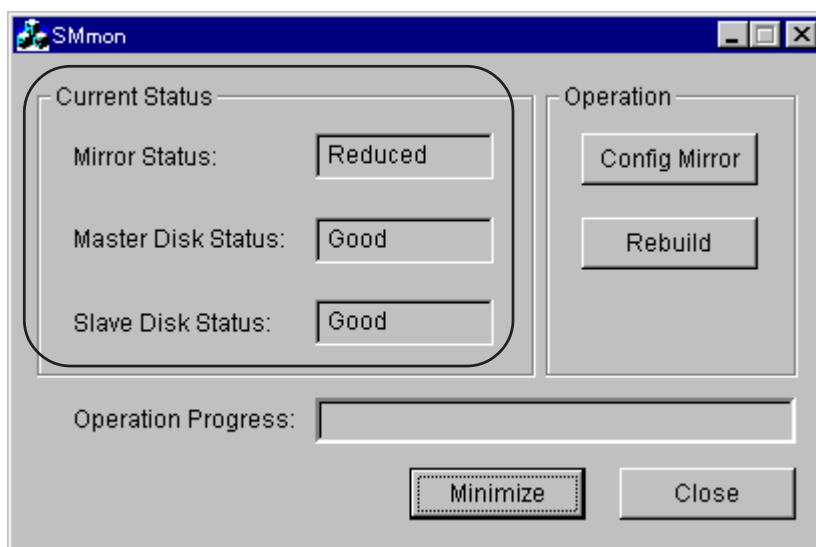

◆ Mirror Status

This menu provides the current status of the Mirroring Disk operation. The Array conditions are "Unconfig", "Good", "Reduced", "Dead" and "Rebuild".

Unconfig	Initial condition. Indicates Mirroring is not yet activated.
Good	Indicates Mirroring is being performed normally.
Reduced	During "Good" operation, indicates that an error has occurred in one of the HDD units and that only one is operating. <u>After confirming which disk is not operating, change the unit for a new one as soon as possible.</u>
Dead	During "Reduced" operation, indicates that an error has occurred. If operation continues, there is the possibility that the PL unit's OS (system) can stop operating. <u>Therefore, it is strongly recommended that you backup your current PL data and replace the non-operating HDD unit as soon as possible.</u>
Rebuild	The Mirroring Disk unit is now being rebuilt.

When Windows is restarted or shutdown, disk status information is destroyed. This may prevent the Hard Disk Mirroring utility from being able to identify which hard disk is damaged. In this case, use the [Event Viewer] to check which hard disk is damaged. **Reference** Chapter 4 - Error Messages

◆ Master Disk Status / Slave Disk Status

These items display the condition of the HDD units connected to the PL. Hard Disk conditions can be "No Device", "Good", "Broken" or "CD-ROM".

No Device	Indicates that no device is connected.
Good	Indicates normal disk unit operation.
Broken	Indicates a disk error has occurred.
CD-ROM	Indicates the CD-ROM Drive is connected.

■ Monitoring via the RAS System Monitor

The RAS system monitor can be used to monitor the status of the Mirror Disk operation. The following explanation uses screens from a PL-X920 Series unit.

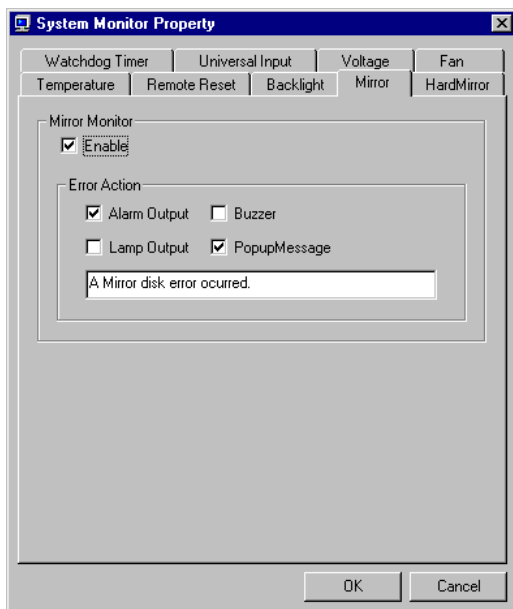

1. Click on the [Start] -> [Program] -> [System Monitor] -> [System Monitor Property] selections. In the [System Monitor Property] screen, click the [Mirror] tab's [Mirror Monitor] selection's [Enable] check box to select/enable it. If desired, click the [Error Action] check box to enable that feature.

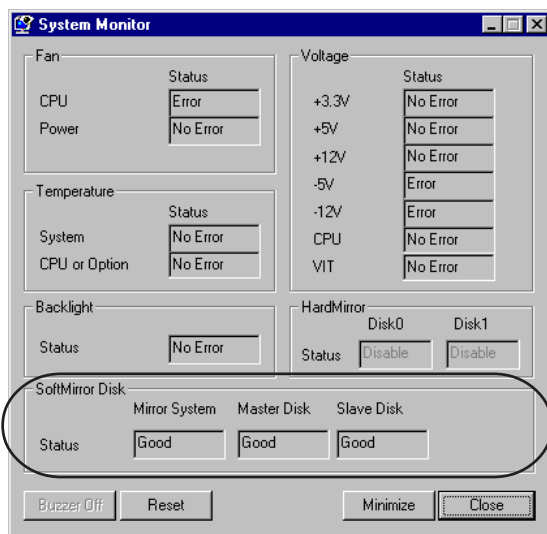

2. You can monitor the condition of the Mirror Disk unit by clicking the [Start] -> [Program] -> [System Monitor] -> [System Monitor] selection.

■ Monitoring via a Customer Application.

A customer application can be used to monitor the status of the Mirroring Disk unit. For details, please refer to the following manual.

- ▼ **Reference** ▲ *PL-5900 Series User Manual*
A.7 System Monitor/RAS Feature API-DLL
- PL-6920/PL-7920 Series User Manual*
A-4 System Monitor/RAS Feature API-DLL
- PS-2000B Series RAS-API Reference Manual*

■ Software Mirroring Disk Operation Flow (1)

The Software Mirroring Disk operation cycle, from installation to error handling, is as follows.

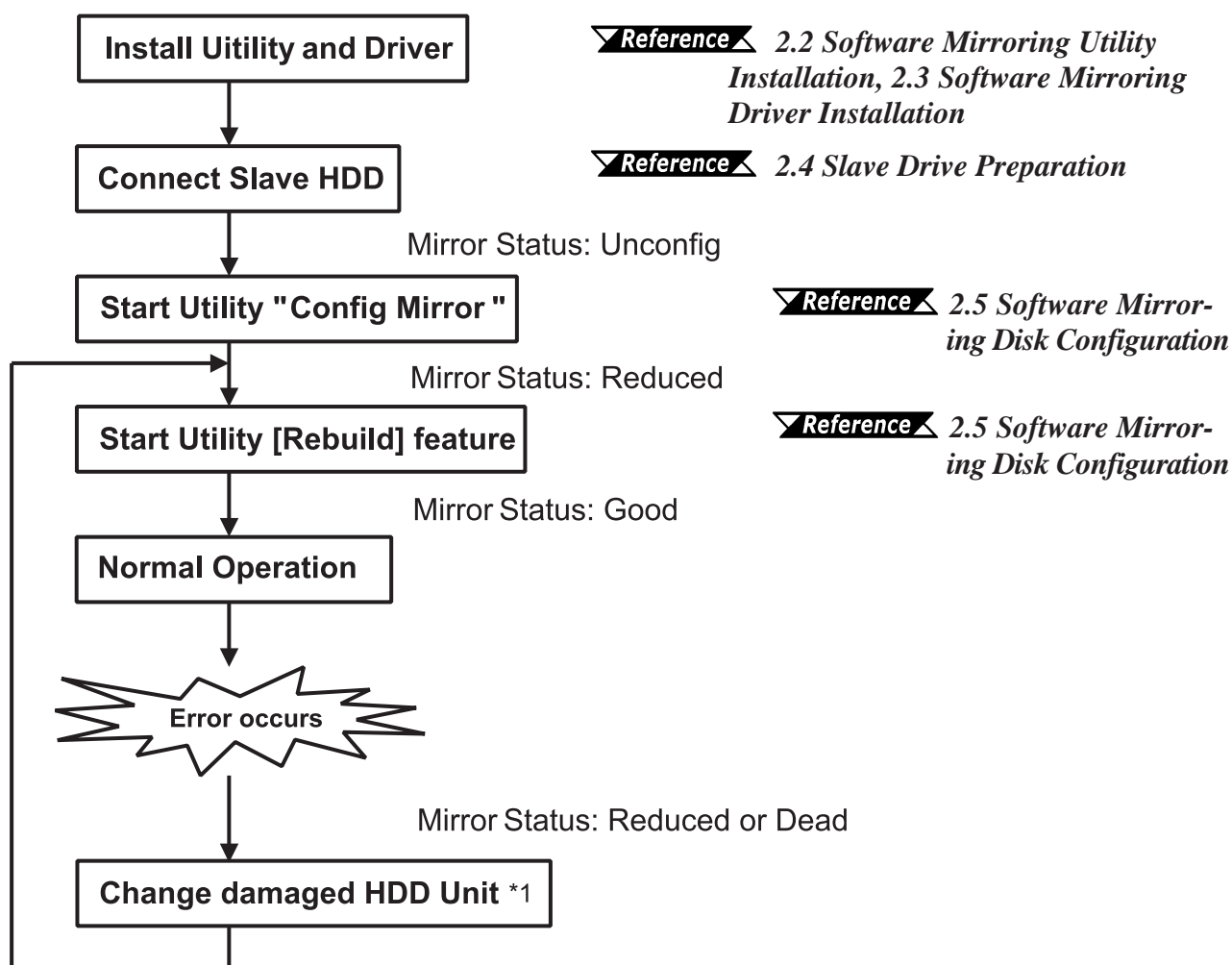

*1 Do not change the HDD unit's Master/Slave settings.

■ Software Mirroring Disk Operation Flow (2) (Excluding PS-2000B units)

When Pro-face's optional CD-ROM drive (PL-DK200) is used to install user applications, the following operation flow is used.

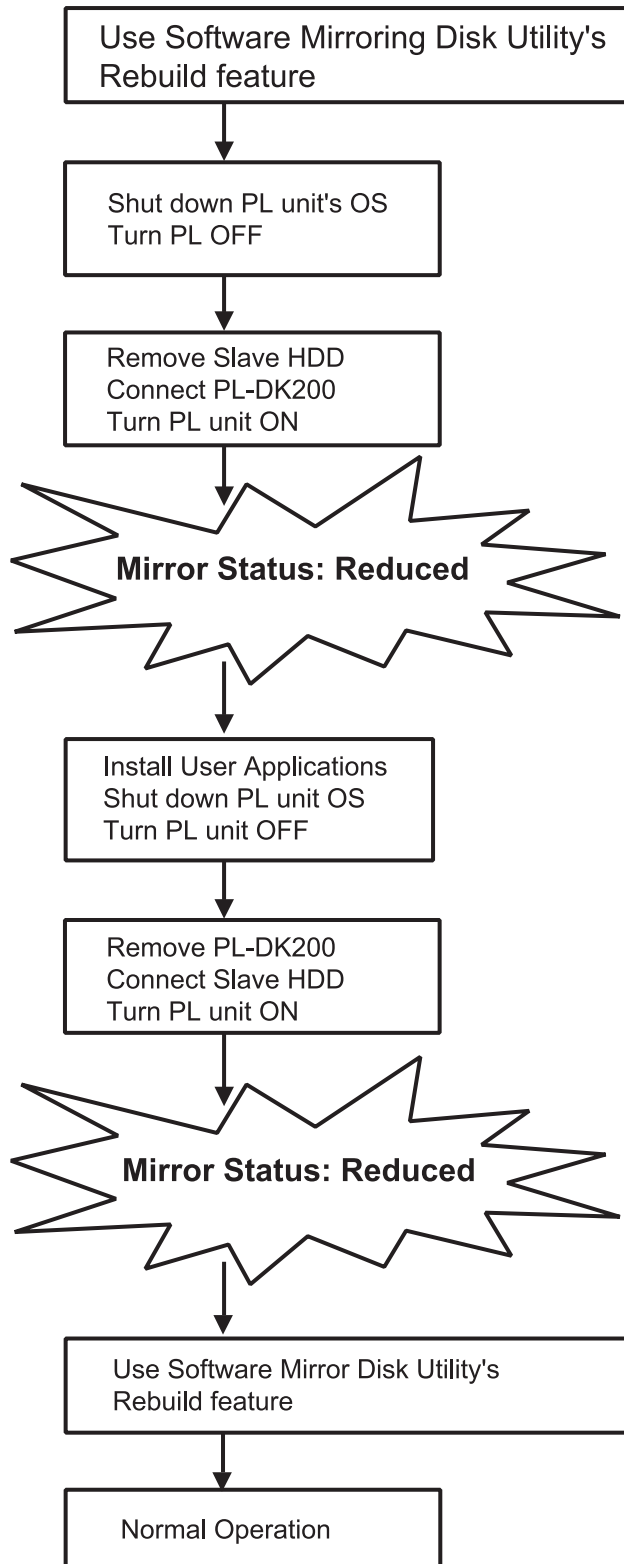

When an error occurs in a single HDD unit, and its status becomes "Reduced", as soon as possible, change the drive for a new one and configure it.

If an HDD unit continues to have errors, its status can become "Dead" and all the data in the HDD can be lost.

If both HDD units have errors and the system is still operating, save all important data to a separate, external media. Then, replace both HDD units and create a new Master drive.

When first using the Mirroring Disk system (initial start-up, or when both disks have failed and have been exchanged), be sure to follow the steps given below.

▼Reference▲ 2.5 *Software Mirroring Disk Configuration,*

PL-5900 Series User Manual 5.2 System Parameters

PL-6920/PL-7920 Series User Manual 5-2 System Parameters

PS-2000B Series User Manual 3.2 System Parameters

With a PL-5900 Series Unit

In the "System Information" area's "ADVANCED BIOS FEATURES" screen, enter the following settings.

First Boot Device : Floppy
 Second Boot Device : HDD-0
 Third Boot Device : CDROM

With a PL-X920 Series Unit or PS-2000B Series Unit

In the "System Information" area's "ADVANCED BIOS FEATURES" screen, enter the following settings.

First Boot Device : Floppy
 Second Boot Device : HDD-0
 Third Boot Device : CDROM
 Fourth Boot Device : Disabled

■ When the Master HDD cannot be recognized

When the Master HDD is damaged to the point where it cannot be recognized, BIOS will set the Slave HDD as HDD-0. However, since this changes the Second Boot Device to HDD-1, the OS cannot properly start up. Nevertheless it is the Mater/Slave HDD, use the BIOS setting screen to set the Second Boot Device to HDD-0.

4 Error Messages

■ LED

For the PS-2000B Series and PL-X920 Series units, if the software mirroring disk error is detected during RAS System Monitor operation, the LED indicator will blink Orange/Green.

■ Event Log

Whenever Software Mirroring Disk features are changed, or a device error is detected, the driver will write data to an Event Log.

The events output by the Software Mirroring Disk Driver will be written to the Event Log's System Log.

Event Log data can be viewed using the Event Viewer.

To start the Event Viewer:

[With Windows NT®]

[Start] -> [Program] -> [Control Tools] -> [Event Viewer] will start the Event Viewer.

[With Windows® 2000]

[Control Panel] -> [Control Tools] -> [Event Viewer] will display the contents of the System Log.

■ Event Details

The Event Log details will appear as follows.

Event ID : 11
Source : smide
Type : Error
Class : None

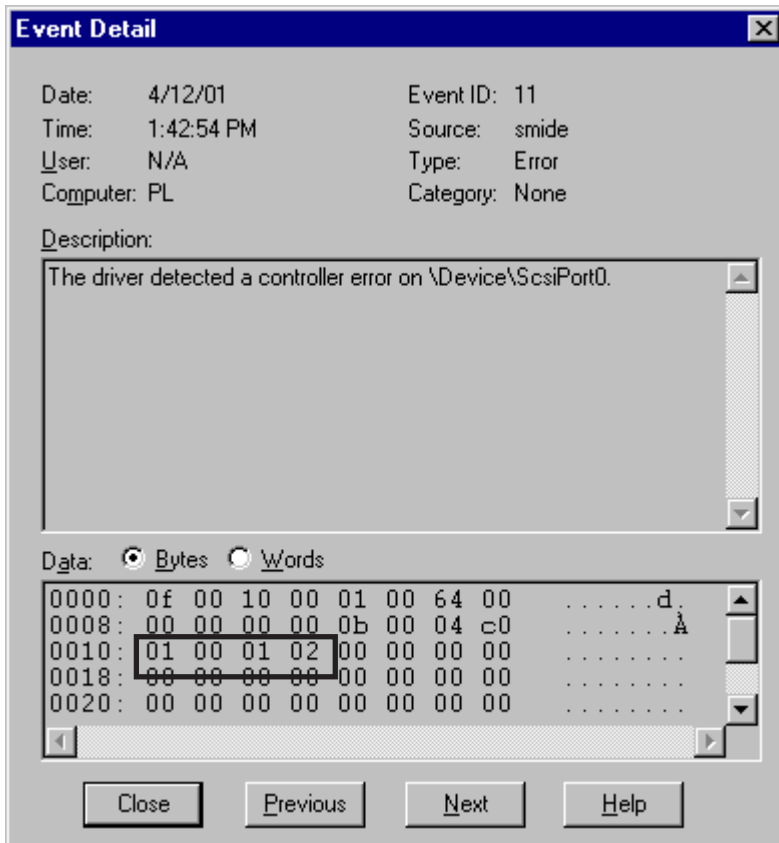

The previous page's picture shows the code data output by the Software Mirroring Disk Driver during Event Log creation. This data can be seen in the above rectangle, which frames the four (4) bytes of data following "0010h". Depending on the code data output, you can diagnose if the problem is due to a Mirroring Disk condition change or a device error.

■ Code Details

The Code details are as follows. When the first byte is "00", the Mirroring Disk's status change has been recorded.

Byte No. 1	Byte No. 2	Byte No. 3	Byte No. 4
Indicates a change in the Mirroring Disk's status	Fixed at "00"	Indicates the status of the Mirroring Disk prior to the status change.	Indicates the status of the Mirroring Disk after the status change.
00: Mirror Disk status change		00: Good 01: Not output 02: Unconfigured 03: Rebuilding 04: Reduced 05: Dead	00: Good 01: Not output 02: Unconfigured 03: Rebuilding 04: Reduced 05: Dead

When the first byte is "01", a Device Error (HDD, CD-ROM) has been recorded.

Byte No. 1	Byte No. 2	Byte No. 3	Byte No. 4
Indicates a device error has occurred.	Fixed at "00"	The device with the error is shown by the following codes.	The type of error is shown by the following codes.
01: Device error		00: Device that is connected to the Master. 01: Device that is connected to the slave.	00: Read Error 01: Write Error 02: Other error

Other errors will occur when the connected device is changed.

■ Software Mirroring Disk Condition Messages

Code	Mirroring Disk Condition Change
00 00 02 04	Changed from Unconfig to Reduced
00 00 00 04	Changed from Good to Reduced
00 00 00 05	Changed from Good to Dead
00 00 04 05	Changed from Reduced to Dead
00 00 04 03	Changed from Reduced to Rebuild
00 00 03 05	changed from Rebuild to Good

■ Device Condition Messages

Code	Device Condition Change
01 00 00 XX	Master HDD has changed from Good to Broken
01 00 01 XX	Slave HDD has changed from Good to Broken