



# WARNINGS

- To prevent an electrical shock, be sure to disconnect the power cord wires from the PL-5910 Series unit (hereafter referred to as the "PL") before connecting the cord to the main power supply.
- A fire or electrical shock may occur if input voltage used with the PL is beyond the specified range. Be sure to use only the specified voltages.
- Before opening the PL unit's protective cover, be sure to turn the unit's power OFF. This is because the PL unit's internal parts carry high voltages.
- To avoid fires or electrical hazards, do not modify the PL in any way.
- Do not create touch panel switches that are used to either control or to ensure the safety of equipment and personnel. Mechanical switches, such as an emergency stop switch, a deadman (two-handed) start switch, etc., must be installed and operated via a separate control system.
- Do not create touch panel switches which could possibly endanger the safety of humans or equipment. This is due to the possibility of a malfunction in the PL or its cable(s) causing the output of a signal that could result in a major accident. All of a system's major, safety-related switches should be designed to be operated separately from the PL.
- After the PL unit's backlight burns out, unlike the PL unit's "Standby Mode", the touch panel is still active. If the operator fails to notice that the backlight is burned out and touches the panel, a potentially dangerous machine miss-operation can occur. If your PL unit's backlight suddenly turns OFF, use the following steps to determine if the backlight is actually burned out.
  - 1) If your PL is not set to "Standby Mode" and the screen has gone blank, your backlight is burned out.
  - 2) Or, if your PL is set to Standby Mode, but touching the screen does not cause the display to reappear, your backlight is burned out.
- If metal particles, water or other types of liquids contact any of the PL unit's internal parts, immediately turn the unit's power OFF, unplug the power cord, and contact either your PL distributor or the Digital Electronics Corporation.
- Before either plugging in or unplugging a board or interface connector, be sure to turn the PL unit's power OFF.
- To prevent a possible explosion, do not install the PL in areas containing flammable gases.
- The PL is not appropriate for use with aircraft control devices, aerospace equipment, central trunk data transmission (communication) devices, nuclear power control devices, or medical life support equipment, due to these devices' inherent requirements of extremely high levels of safety and reliability.
- When using the PL with transportation vehicles (trains, cars and ships), disaster and crime prevention devices, various types of safety equipment, non-life-support-related medical devices, etc. redundant and/or fail-safe system designs for reliability and safety.

## To Prevent Accidents

- Do not push on the PL unit's screen too strongly, with either your finger or with a hard object. Excessive pressure can scratch, crack or damage the screen. Do not use a pointed object, such as a mechanical pencil or screwdriver, to press any of the touch panel's switches, since they can damage the display.
- If the screen becomes dirty or smudged, moisten a soft cloth with diluted neutral detergent, wring the cloth well, and wipe the display. Do not use thinner or organic solvents.
- Avoid storing and operating the PL in direct sunlight, high temperatures and humidity, and in areas where excessive dust and vibration will occur.
- Avoid using the PL in areas where sudden, extreme changes in temperature can occur. This may cause condensation to form inside the unit, possibly leading to an accident.
- To prevent the PL from overheating, be sure its air circulation vents are clear and clean, and keep the unit's operation area well-ventilated.
- Avoid operating or storing the PL near chemicals, or where chemicals can come into contact with the unit.
- The Digital Electronics Corporation shall not be held responsible or provide any compensation for damage(s) caused by the loss of data stored in the PL unit's hard disk drive (HDD). It is therefore strongly suggested that all important data and software be backed up regularly to an external data backup device.
- After turning OFF the PL unit's power, wait until the internal HDD stops spinning before turning on the power again (approx. 5 seconds).
- To extend the life of your PL unit's hard disk, use the BIOS menu [POWER MANAGEMENT SETUP] - [HDD Power Down] setting to turn the HDD unit's power OFF when the HDD is not being used. Recommended setting is the factory setting of "5Min". When using Windows<sup>®</sup>2000, use the [Start] - [Settings] - [Control Panel] - [Power Options] - [Turn off hard disks] setting to turn the HDD unit's power OFF when not in use. Recommended setting is [After 5 mins].

## PL-5910 Series Model Numbers

The term “PL-5910 Series” refers to the following PL model numbers:

Series	Model	Model Number	Power Input Type	Note
PL-5910	PL-5910T	PL5910-T11	AC100V type	-
		PL5910-T41-24V	DC24V type	UL/c-UL/CSA Approved, CE Marked
	PL-5911T	PL5911-T11	AC100V type	-
		PL5911-T41-24V	DC24V type	UL/c-UL/CSA Approved, CE Marked

## UL/c-UL Application Notes

PL5910-T41-24V/PL5911-T41-24V Series units are UL/c-UL 60950 recognized components. (UL File No. E171486). Please pay special attention to the following instructions when applying for UL/c-UL approval for machinery which includes any of these PL units.

Equipment with a PL installed in it requires UL evaluation for the combination of the PL and equipment.

**The PL conforms as a component to the following standards:**

■UL 60950-1

Standard for Safety of Information Technology Equipment, including Electrical Business Equipment (Third Edition, dated December 1, 2001)

■CSA-C22.2 No. 60950-1-03 (c-UL recognition)

Standard for Safety of Information Technology Equipment, including Electrical Business Equipment (Third Edition, dated December 1, 2001)

PL5910-T41-24V (UL Registration Model: 3382701-01)

PL5911-T41-24V (UL Registration Model: 3382701-02)

<Caution>

- The PL’s FACE section is evaluated as an Enclosure, and all other areas are evaluated as an Open Enclosure.
- Use the PL indoors only.
- When connecting the PL unit’s power cord, be sure to use a cord that is appropriate for the current and voltage used, and that has conductive wires that are 0.75 mm<sup>2</sup> or larger.
- When an end-use product will include the PL, be sure to design the PL unit’s power cutoff switch as a separate disconnect device and locate it where the operator can easily reach it.
- Danger of explosion exists if the backup battery is incorrectly replaced. Replace this battery only with same or equivalent type recommended by the manufacturer. Dispose of used batteries according to the manufacturer’s instructions.

## CE Marking Notes

PL5910-T41-24V/PL5911-T41-24V Series units are CE marked products that conform to EMC directives EN55011 (Group 1 Class A) and EN61000-6-2.

# Package Contents

The PL package should include the following items:

## ■ PL Unit

(PL-5910T/PL-5911T)

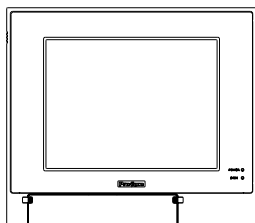

## ■ Power Cord

(Included with PL5910-T11/PL5911-T11 units)

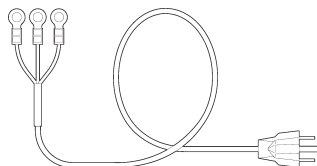

## ■ Installation Fasteners(4)

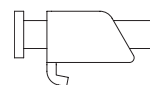

- Be careful when installing the PL not to damage the built-in HDD.
- The power cord is designed only for AC100V/AC115V use. Any other voltage will require a different cable.

## ■ Installation Gasket



## ■ CD-ROM (1)

PL-5910 Series User Manual & Driver CD



## ■ Function Labels



Attach the function labels as shown below.

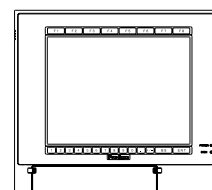

## ■ Installation Guide (Japanese/English)



**CD-ROM contains the PL-5910 Series User Manual (PDF file) as well as related utility software and drivers. Refer to this manual for details.**

When you order a PL unit built to your specifications, the PL package should include all optional item Installation Guides. Be sure to check that these were included.

# About the PDF Manual

The CD-ROM contains the following PDF manual file.

- Panel Computer PL-5910 Series User Manual (pl5910e.pdf)
- Panel Computer PL-5910 Series API Reference Manual (5910apie.pdf)

Adobe Corporation's Acrobat® Reader software must be installed to read a PDF file.

To install the Acrobat® Reader software, follow the steps given below.

- 1) This software, in the form of a self-extracting file, is located in this CD-ROM in the folder titled [Reader]. Use the Explorer software to locate the file [Reader\ENG\ar60eng.exe], and double-click on the file icon to install the software.
- 2) After Installation begins, follow the instructions given on the Installation screens.

To view the PDF manual contained in this CD-ROM, perform the following steps.

- 1) Use the Explorer software to locate the file pl5910e.pdf or 5910apie.pdf in the folder titled [manual].
- 2) Double-click on the PDF file's icon. Acrobat® Reader will automatically start and the first page of the PDF manual will appear.

# 1

## PL External Features

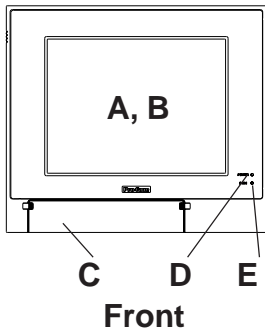

Front

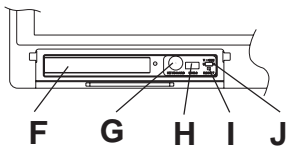

Behind Front Maintenance Cover

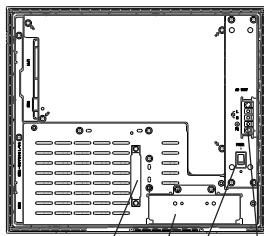

Rear

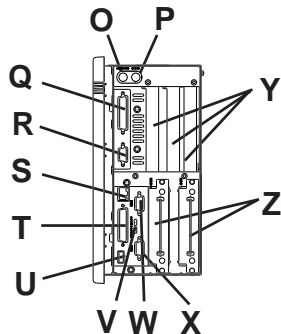

PL-5910T Right Side

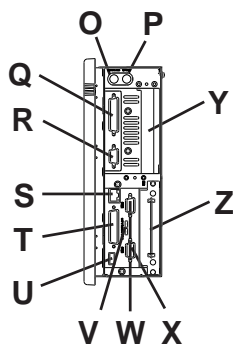

PL-5911T Right Side

- A : Display Area
- B : Touch Panel
- C : Front Maintenance Cover
- D : Power LED
- E : Hard Disk Access LED (DISK)
- F : FDD Front Blank Panel
- G : Keyboard Connector (KEYBOARD)
- H : USB Connector(USB)
- I : Hardware Reset Switch (RESET)
- J : Touch Panel I/F Select Switch (T MODE)
- K : IDE I/F Cover
- L : FDD Rear Blank Panel
- M : Power Switch (POWER)
- N : Power Input Terminal Block
- O : Keyboard Connector (KEYBOARD)
- P : Mouse Connector (MOUSE)
- Q : Printer Connector (LPT1)
- R : RS-232C Connector (COM1)
- S : Ethernet Connector (10/100 BASE-TX)
- T : RAS Connector (RAS)
- U : USB Connector (USB1)
- V : Signal Changeover Slide Switch (+5VRI)
- W : RS-232C Connector (COM2)
- X : RS-232C Connector (COM3)
- Y : Expansion Slot
- Z : HDD/CF Card Unit Expansion Slot

# 2

## PL Dimensions (with Attachment Fastner)

- PL-5910T Dimensions

Unit:mm[in] - excluding projections

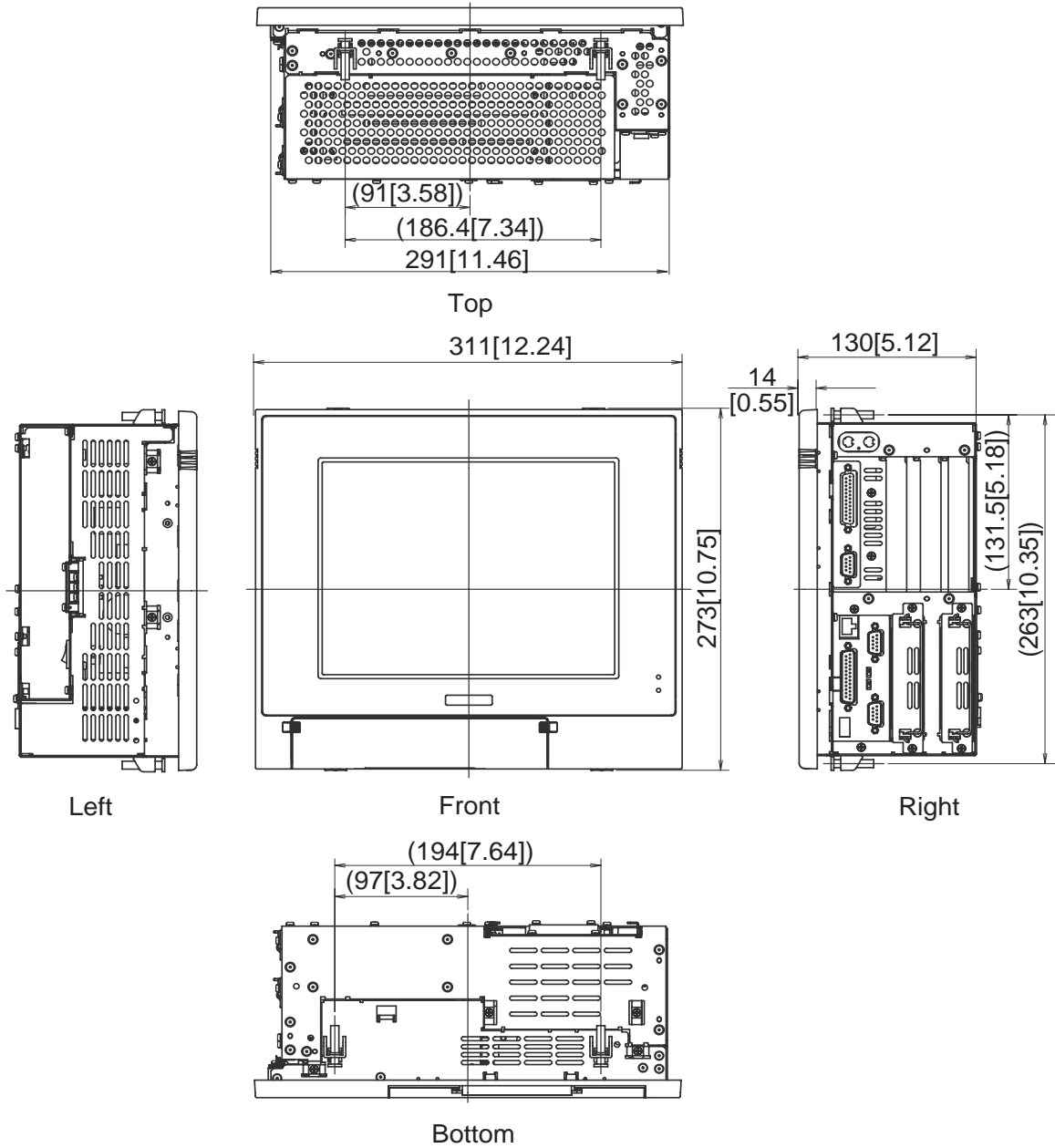

• PL-5911 Dimensions

Unit:mm[in] - excluding projections

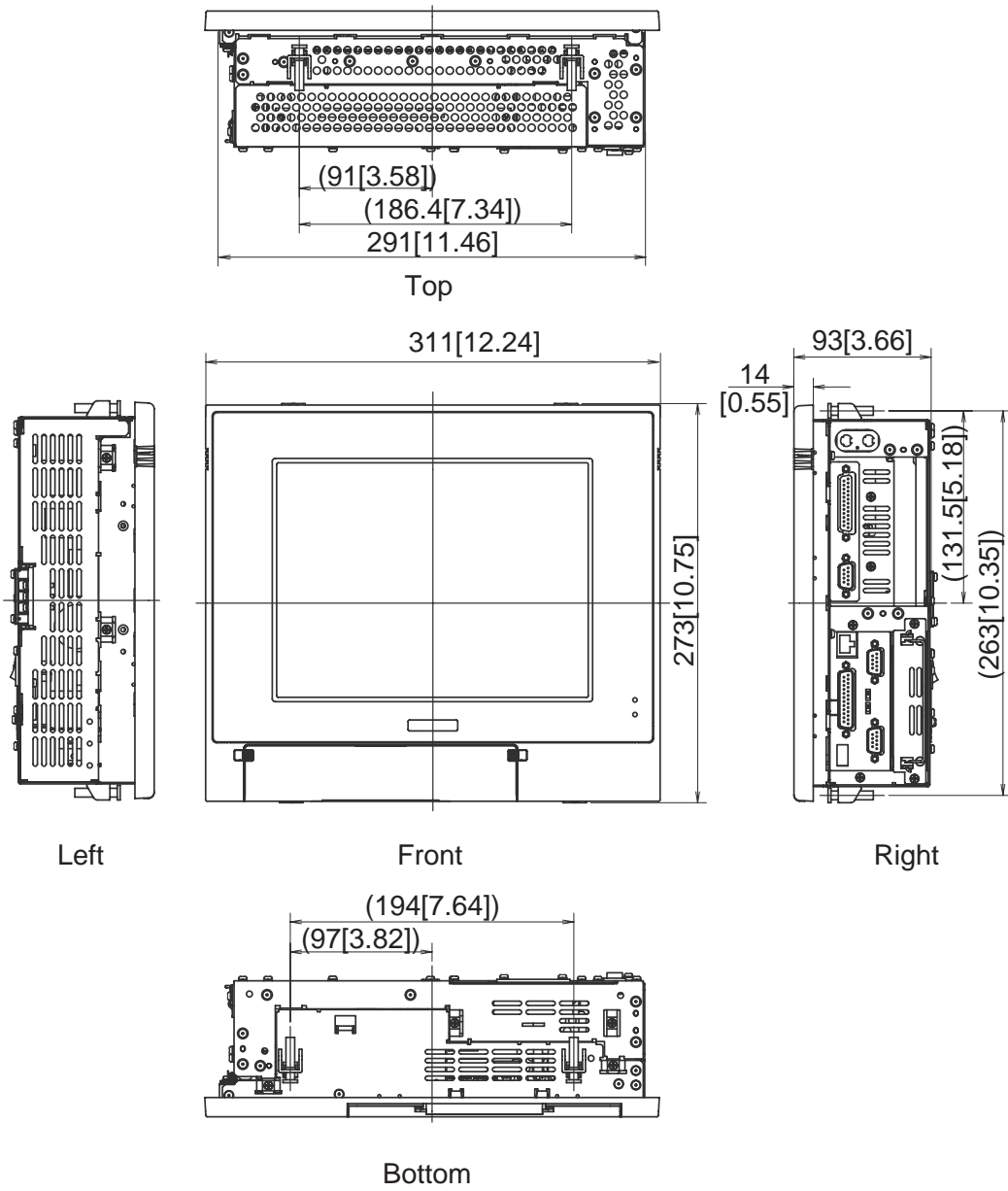

### 3

## General Specifications

### ■ Electrical

#### ◆ PL5910-T11/PL5911-T11

	PL5910-T11	PL5911-T11
Rated Voltage	AC100V	
Voltage Range	AC85V to AC132V	
Frequency	50/60Hz	
Allowable Voltage Drop	1 cycle or less (pause occurrences must be more than 1 second apart)	
Power Consumption	150VA or less	110VA or less
Voltage Endurance	AC1500V 20mA for 1 minute (between charging and FG terminals)	
Insulation Resistance	10M $\Omega$ or higher at DC500V (between charging and FG terminals)	

#### ◆ PL5910-T41-24V/PL5911-T41-24V

	PL5910-T41-24V	PL5911-T41-24V
Rated Voltage	DC24V	
Voltage Range	DC19.2V to DC28.8V	
Allowable Voltage Drop	10 ms or less (pause occurrences must be more than 1 second apart)	
Power Consumption	100W or less	80W or less
In-rush Current	30A or less	
Voltage Endurance	AC1000V 10mA for 1 minute (between charging and FG terminals)	
Insulation Resistance	10M $\Omega$ or higher at DC500V (between charging and FG terminals)	

■ Environmental

Ambient Operating Temperature	0°C to 45°C (with HDD attached: 5°C to 45°C)
Storage Temperature	-10°C to +60°C
Ambient Humidity	10%RH to 85%RH (wet bulb temperature of 29°C or less)
Storage Humidity	10%RH to 85%RH (wet bulb temperature of 29°C or less)
Air Purity Level	0.1mg/m <sup>3</sup> or less (free of conductive particles and dust)
Pollution degree	Pollution degree 2
Atomospheric Pressure	800 to 1114hPa (2000 meters or lower)
Vibration Resistance	19.6m/s <sup>2</sup> at 10Hz to 25Hz in X, Y, Z directions for 30 minutes With HDD attached: 4.9m/s <sup>2</sup> With FD unit attached: 9.8m/s <sup>2</sup>
Noise Endurance	Noise Voltage: 1500Vp-p Pulse Width: 50ns, 500ns, 1ms Rise Time: 1ns (via noise simulator)
Electrostatic Discharge Immunity	Contact: 4kV IEC 61000-4-2 Level 2 Air Borne: 8kV
Noise Immunity (First transient burst noise)	Power Line: 2kV IEC 61000-4-4 COM Port: 1kV IEC61000-4-4



- When using a PL optional unit, be sure to check that unit's specifications for any special conditions or cautions that may apply to its use.
- Since the PL unit's hard disk drive (HDD) is a consumable item, i.e. it has a limited lifetime, be sure to back up its data regularly and prepare a spare HDD unit.
- The Hard Disk lifetime specified here may be reduced due to unforeseen environmental factors, however, the disk should operate for 20,000 hours or approximately 5 years, whichever comes first, at an operating temperature of 20°C and approximately 333 hours of operation per month. (HDD access frequency of 20% or less)
- Using the Hard Disk in an environment that is excessively hot and/or humid will shorten the disk's operation life. A wet bulb temperature of 29°C or less is recommended, which is equivalent to the following data.

Temperature	Humidity
at 35°C	no higher than 64%RH
at 40°C	no higher than 44%RH





- To extend the life of your PL unit's hard disk, use the BIOS menu [POWER MANAGEMENT SETUP] - [HDD Power Down] setting to turn the HDD unit's power OFF when the HDD is not being used. Recommended setting is the factory setting of "5Min". When using Windows®2000, use the [Start] - [Settings] - [Control Panel] - [Power Options] - [Turn off hard disks] setting to turn the HDD unit's power OFF when not in use. Recommended setting is [After 5 mins].

#### ■ Structural

	PL-5910T	PL-5911T
Grounding	Exclusive (Use your country's applicable standard.)	
Rating <sup>*2</sup> (Front face of unit)	Equivalent to IP65f (JEM 1030) <sup>*1</sup>	
Weight	6.0 kg (13.2 lb) or less	5.5 kg (12.1 lb) or less
Cooling Method	Natural air ventilation	

*\*1 Only PL5910-T11/PL5911-T11 units (Rated voltage: AC100V).*

*\*2 The front face of the PL unit, installed in a solid panel, has been tested using conditions equivalent to the standard shown in this specification. However even though the PL unit's level of resistance is equivalent to the standard, oils that should have no effect on the PL can possibly harm the unit. This can occur in areas where either vaporized oils are present, or where low viscosity cutting oils are allowed to adhere to the face of the unit for long periods of time. If the PL unit's front face protection sheet becomes peeled off, these conditions can lead to the ingress of oil into the PL and separate protection measures are suggested. Also, if non-approved oils are present, it may cause deformation or corrosion of the front panel's plastic cover. Therefore, prior to installing the PL be sure to confirm the type of conditions that will be present in the PL unit's operating environment.*

# 4

## Interface Specifications

### ■ Printer Interface (LPT1)

#### D-sub 25 pin (Female)

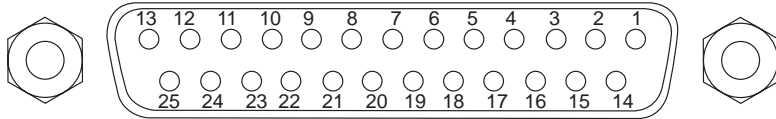

Screw Size: (4-40): Inch Type

**Note:** Electrical Specifications  
**O.D** : Open Drain  
**T.S** : 3 state I/O  
**TTL** : TTL Input

Pin No.	SPP/ECp Mode Signal Name	EPP Mode Signal Name	Direction	Electrical Specif.	Pin No.	SPP/ECp Mode Signal Name	EPP Mode Signal Name	Direction	Electrical Specif.
1 <sup>*1</sup>	$\overline{\text{STRB}}$	$\overline{\text{WRITE}}$	In/Output	O.D/T.S	14	$\overline{\text{AUTOFD}}$	$\overline{\text{DSTRB}}$	In/Output	O.D
2	DATA0	DATA0	In/Output	O.D	15	$\overline{\text{ERROR}}$	$\overline{\text{ERROR}}$	Input	TTL
3	DATA1	DATA1	In/Output	O.D	16 <sup>*1</sup>	$\overline{\text{INIT}}$	$\overline{\text{INIT}}$	In/Output	O.D/T.S
4 <sup>*1</sup>	DATA2	DATA2	In/Output	O.D/T.S	17 <sup>*1</sup>	$\overline{\text{SLCTIN}}$	$\overline{\text{ADSTRB}}$	In/Output	O.D/T.S
5	DATA3	DATA3	In/Output	O.D	18	GND	GND		
6	DATA4	DATA4	In/Output	O.D	19	GND	GND		
7	DATA5	DATA5	In/Output	O.D	20	GND	GND		
8	DATA6	DATA6	In/Output	O.D	21	GND	GND		
9	DATA7	DATA7	In/Output	O.D	22	GND	GND		
10	$\overline{\text{ACKNLG}}$	$\overline{\text{ACKNLG}}$	Input	TTL	23	GND	GND		
11	BUSY	WAIT	Input	TTL	24	GND	GND		
12	PE	PE	Input	TTL	25	GND	GND		
13	SLCT	SLCT	Input	TTL					

*\*1 Pins 1, 4, 16 and 17 will become O.D when the SPP mode specification is used. If the mode changes to ECP or EPP, these pins will become T.S*

### ■ USB Interface (USB)

#### Receptacle

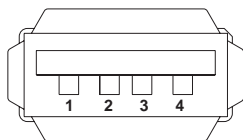

Pin No.	Name
1	Vcc
2	- Data
3	+ Data
4	GND

■ Keyboard Interface/Mouse Interface

(The PL's front and side connectors are the same)

Mini - DIN 6 pin (Female)

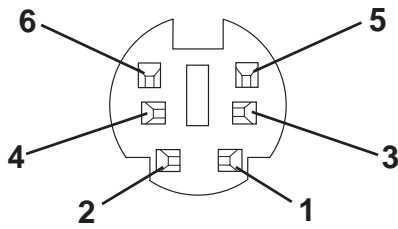

Keyboard

Pin No.	Signal Name
1	KEYDATA
2	NC
3	GND
4	+5V
5	KEYCLK
6	NC
SHIELD	GND

Mouse

Pin No.	Signal Name
1	Mouse DATA
2	NC
3	GND
4	+5V
5	Mouse CLK
6	NC
SHIELD	GND



- 107 key (English) and 112 key (Japanese) ACPI-compatible keyboards cannot be used. Be sure your keyboard is a 101 key, 104 key (English), 106 key, or 109 key (Japanese) keyboard.

■ RS-232C Interface (COM1/COM2/COM3)

Dsub 9 pin (Male)

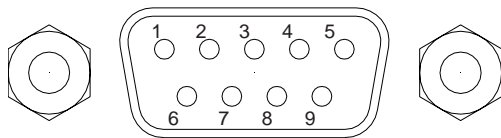

Screw Size: (4-40): Inch Type

Pin No.	Signal Name	Pin No.	Signal Name
1	DCD	6	DSR
2	RXD	7	RTS
3	TXD	8	CTS
4	DTR	9	RI/+5V
5	GND		



- The GND terminal is the signal ground. Be sure to connect the GND terminal to the other unit's SG (signal ground).

Number 9 pin's [RI/+5V] changeover is COM2 and COM3. COM1 becomes [RI]. To set the changeover for COM2 and COM3, remove the PL's rear maintenance cover and locate the main function switches, next to the PL's circuit board. To change COM2, set main function switch SW2 to ON, and COM2 will change to +5V. The factory setting is OFF and [RI]. To change COM3, turn SW3 to ON.

**Reference** *PL-5910 Series Panel Computer User Manual, 2.3.4 RS-232C Interface (COM1/COM2/COM3)*



- Be sure to confirm what settings will be used by the other device and set the dip switches accordingly. Failure to do so can result in a unit malfunction or damage.
- Whenever changing the PL Main Function switches, be sure to first turn the PL's power supply OFF. Failure to do so can cause a PL malfunction.

■ RAS Interface

**Dsub 25 pin (Male)**

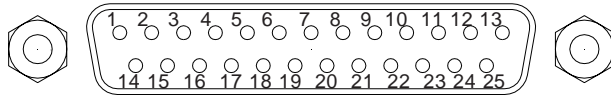

**Screw Size:** (4-40): Inch Type

Pin No.	Signal Name	Pin No.	Signal Name
1	GND	14	GND
2	+5V (max. 100mA)	15	+5V
3	+12V (max. 100mA)	16	NC
4	NC	17	NC
5	RESET INPUT (+)	18	NC
6	DIN 0 (+)	19	NC
7	DOUT (-)	20	NC
8	DOUT (+)	21	LAMP OUT (-)
9	ALARM OUT (-)	22	LAMP OUT (+)
10	ALARM OUT (+)	23	NC
11	RESET INPUT (-)	24	DIN1 (-)
12	DIN 0 (-)	25	NC
13	DIN 1 (+)		



- When using No.2 (+5V) and No.3 (+12V) External Power Output, be sure to use only the designated level of current. Failure to do so can cause equipment damage or a unit malfunction.

◆ External Input Signal (Dual use of DIN, Remote Reset Input Port)

<b>Input Voltage</b>	DC12V to DC24V
<b>Input Current</b>	7mA
<b>Operating Voltage</b>	ON voltage: 9V (min), OFF voltage:3V (max)
<b>Isolation Method</b>	Via photocoupler

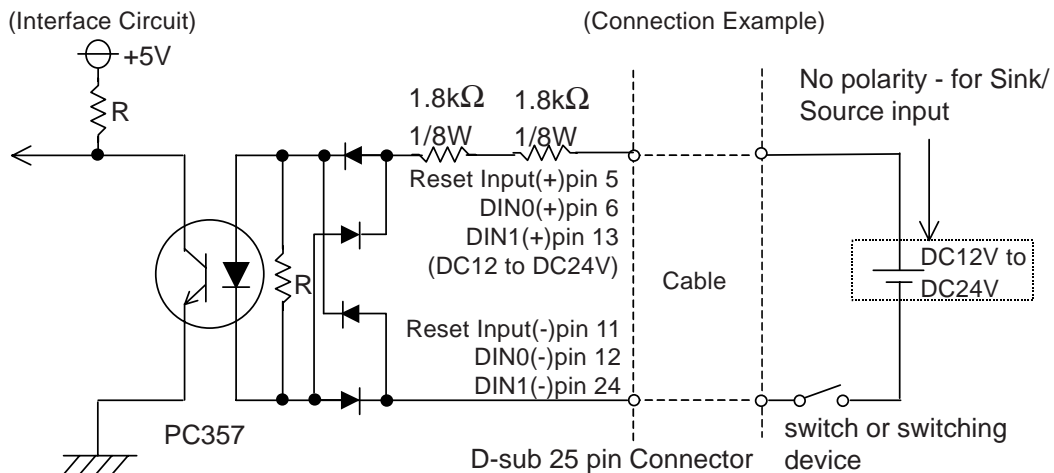



- General Purpose Input (DIN) level must be 1.5 seconds or longer to be detected.
- Be sure the voltage value between terminals is controlled via the input voltage, so that the PL is operated within its recommended range. If the input voltage exceeds this range, the PL may be damaged or malfunction.
- With Sink/Source input, even if the D (-), and RESET (-) are positive, and D (+), RESET (+) are negative, no problems are created. Be sure to operate the unit within the recommended voltage range.

◆ **External Output Signal**  
(Dual use of DOUT/Alarm Output/Lamp Output/Port)

<b>Rated Load Voltage</b>	DC12V to DC24V
<b>Maximum Load Current</b>	100mA/point
<b>Maximum Voltage Drop between Terminals</b>	1.5V (at 100mA load current)
<b>Isolation Method</b>	Via photocoupler

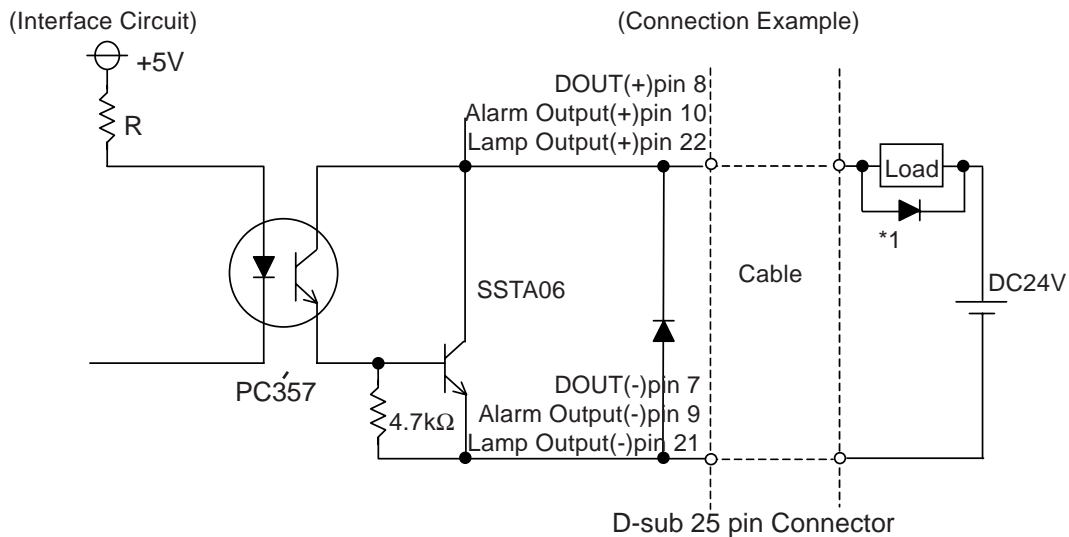

- Be sure to operate the unit within its maximum load current. If the maximum load current exceeds this range, a malfunction or PL damage may occur.
- Design your electrical system by adding the load current and voltage values to the terminal voltage. If load current value used is large, a maximum voltage of 1.5V will exist between the terminals.
- When connecting an induction load, be sure to connect the above drawing's protection diode (\*1).

# 5 Installing the PL

Follow the steps given below when installing the PL.

## ■ Attaching the Moisture Resistant Gasket

Even if the your PL's Moisture Resistant Gasket is not needed to prevent water from entering the unit, the gasket also acts as a vibration absorber and should always be attached. To install it, place the PL face down on a soft surface and attach the gasket to the rear side of the display face, in the plastic bezel's groove (see picture below).



- Before installing the PL into a cabinet or panel, check that the moisture resistant gasket is attached to the unit.
- A gasket which has been used for a long period of time may have scratches or dirt on it, and could have lost much of its water resistance. Be sure to change the gasket at least once a year, or when scratches or dirt become visible.
- Be sure to use gasket model PL-WS500.
- Be sure the gasket's seam is not inserted into any of the unit's corners, only in the straight sections of the groove. Inserting it into a corner may lead to its eventually tearing.
- To ensure the installation gasket's maximum level of moisture resistance, be sure the gasket's seam is inserted as shown into the *panel's bottom face*.

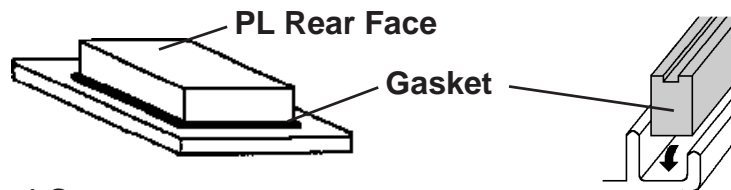

## ■ Create a Panel Cut

Create a panel cut for the PL unit, using the dimensions given here. The moisture resistant gasket and the mounting brackets are also required when installing the PL.

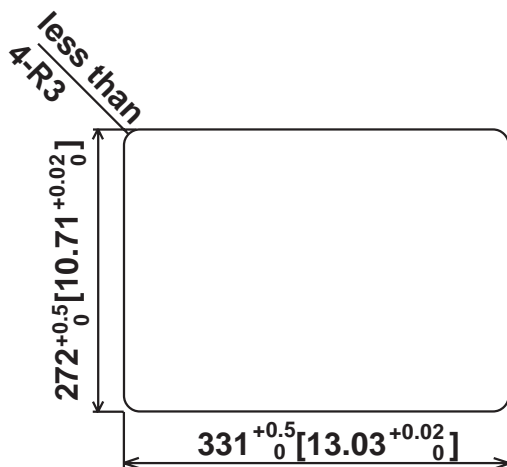

Unit:mm [in.]



- To obtain the maximum degree of moisture resistance, be sure to install the PL on a smooth, flat surface.



- Strengthening may be required for the panel. Be sure to consider the weight of the PL when designing the panel.

## ■ Installation

1) Insert the PL into the panel.



- Be sure the panel cut's actual measurements are the same as those given here, otherwise the PL may shift or fall out of the panel.

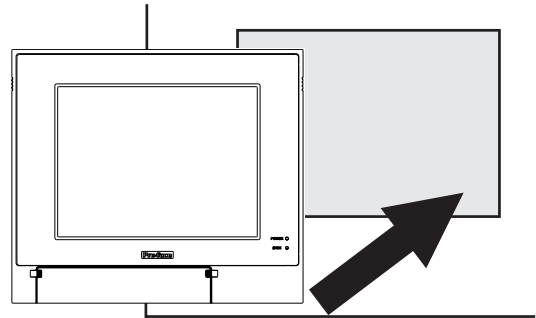

2) Insert the installation fastener hooks into the four installation fastener holes on PL unit's top and bottom sides.

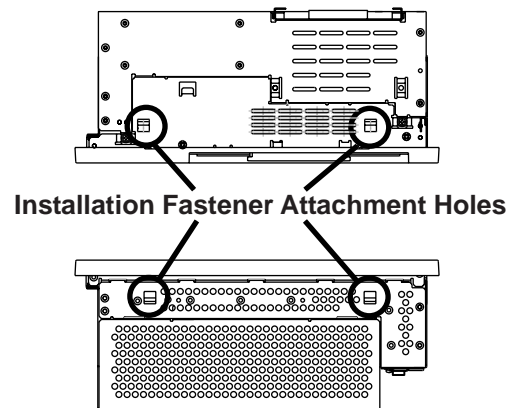

3) Slide the installation fastener back so the hook section catches on the rear of the installation hole.

4) Tighten the installation fastener screws. Be sure to these screws in an even, criss-cross pattern.

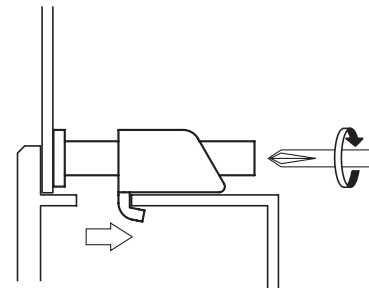

- Do not use excessive force when tightening the installation fastener screws. A torque of only 0.5 N•m is required to provide the specified level of water resistance.

## 6 Wiring the PL

Connect the power cord wires to the PL unit's rear face power terminals.

(Left Side)

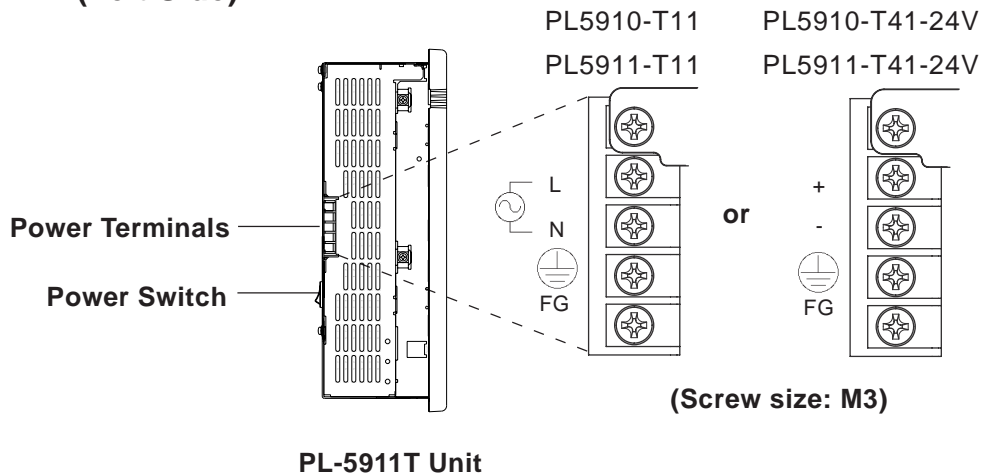

PL5910-T11/PL5911-T11	
<b>L</b>	AC Input Live Line
<b>N</b>	AC Input Neutral Line
<b>FG</b>	Grounding Terminal connected to the PL chassis.

PL5910-T41-24V/PL5911-T41-24V	
<b>+</b>	Positive electrode
<b>-</b>	Negative electrode
<b>FG</b>	Grounding Terminal connected to the PL chassis.

Use the following steps when connecting the power cord wires to the power terminals.



### WARNINGS

- To prevent an electric shock, be sure to turn the PL unit's power supply OFF before connecting the power cord terminals to the PL.
- To prevent fires, electrical hazards and equipment damage, be sure to use only the specified power supply voltage when operating the PL.



- 1) Confirm that the PL unit's power switch is turned OFF. Then, lose two Attachment screws and swing the terminal block cover open. (See drawing.)

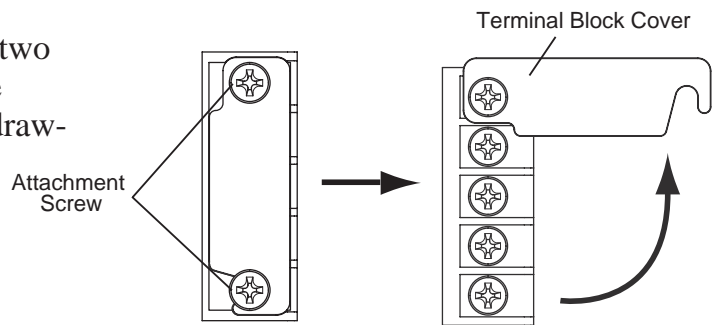

■ PL5910-T11/PL5911-T11

- 2) Remove the middle three attachment screws from the power input terminal block. Align the power cord's crimp terminals with each screw hole and tighten the screws.

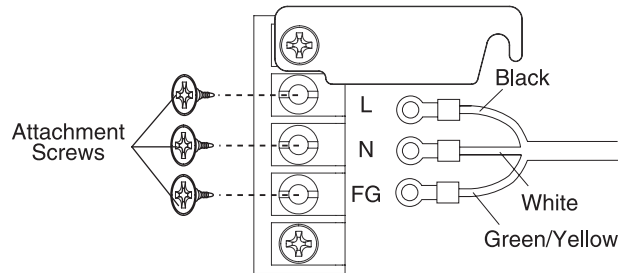

**Crimp Terminal Types :**

**V1.25-3, by J.S.T. or equivalent  
(JIS standard part number :  
RAV1.25-3)**

- **Crimp terminals must be the same as shown below.**

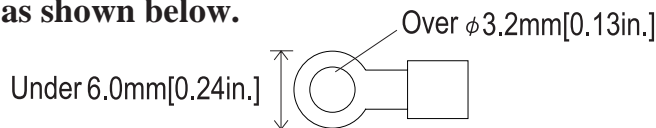

- **Confirm that the ring terminal wires are connected correctly.**
- **The torque required to tighten these screws is 0.5 to 0.6 N•m.**
- **The wire colors indicated in these figures are for the cable included with the PL unit.**
- **This power Cord is designed only for AC100V/AC115V use. Any other voltage level will require a different cable.**



- 3) Swing the terminal block cover closed and secure it in place with its attachment screws. (See drawing.)

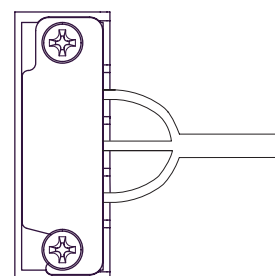

■ PL5910-T41-24V/PL5911-T41-24V

- 2) Remove the middle three screws from the power input terminal block. Align the power cord's crimp terminals with each screw hole and tighten the screws.

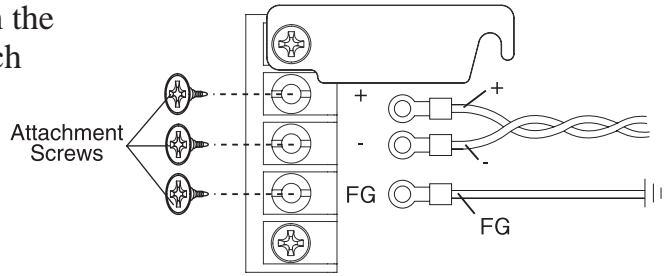

**Note:** Crimp Terminal Types :

V1.25-3, by J.S.T. or equivalent (JIS standard part number : RAV1.25-3)

- Crimp terminals must be the same as shown below.

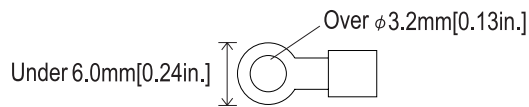

- Confirm that the ring terminal wires are connected correctly.
- The torque required to tighten these screws is 0.5 to 0.6 N•m.

- 3) Swing the terminal block cover closed and secure it in place with its attachment screws. (See drawing.)

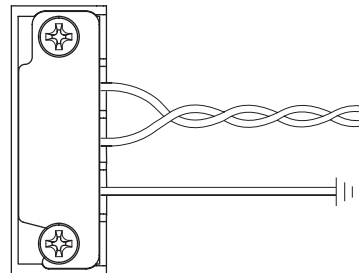

# 7

## Power Supply Cautions

When connecting the power cord's AC power terminals to the PL unit's terminal block, please be aware of the following:

- If voltage fluctuations are expected to vary beyond the specified range, connect a constant voltage transformer.
- Use a low-noise power supply both between the lines and between the PL and its ground. If there is still excess noise, connect an insulating transformer (noise-prevention type).



- **Be sure any constant or insulating transformer used has a capacity of 200VA or more.**

- Wire the power cords of the PL, I/O devices, and power supply devices separately.
- To improve noise immunity, it is recommended to attach a ferrite core to the power cord.
- Isolate the main circuit (high voltage, large current) line, I/O signal lines, and power cord, and do not bind or group them together.
- To prevent damage from lightning, connect a lightning surge absorber.



- Ground the lightning surge absorber (E1) and the PL (E2) separately.
- Select a lightning surge absorber which will not exceed the allowable circuit voltage, even when the voltage rises to the maximum.

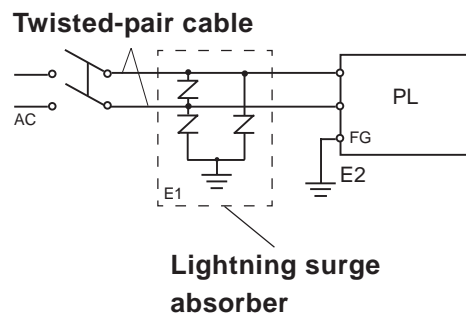
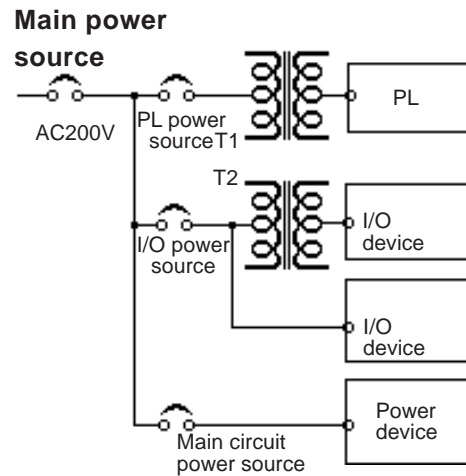
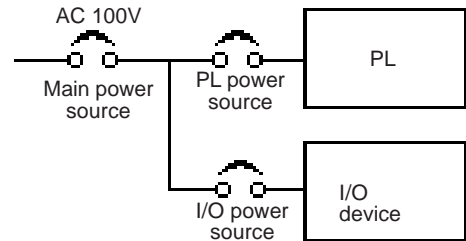
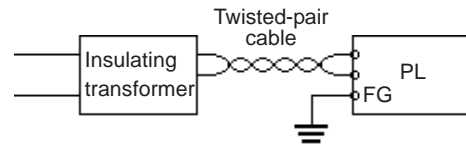
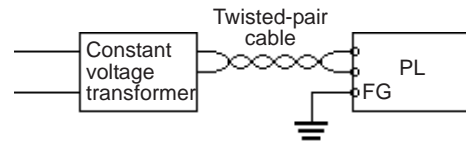

## 8 Grounding Cautions

- Set up a dedicated ground when using the rear panel's FG terminal. Use a grounding resistance of 100Ω., a wire of 2 mm<sup>2</sup> or thicker, or your country's applicable standard.
- If a dedicated ground is not possible, use a shared ground, as shown in figure (b).
- The grounding point must be as close to the PL as possible, and the grounding wires must be as short as possible. If the wires must be long, use thick, insulated wires and run them through conduits.
- When connecting an external device to PL with the SG terminal, check that no short-circuit loop is created when you set up the system.

(a) Dedicated Ground: Best \*1



(b) Shared Ground: Allowed \*1

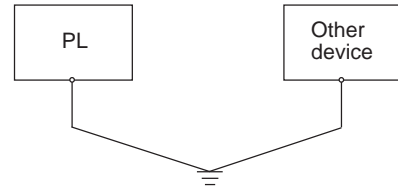

(c) Shared ground - not allowed

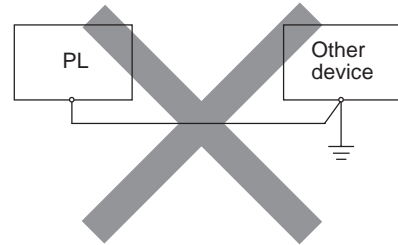

## 9 I/O Signal Line Cautions

- I/O signal lines must be wired separately from the power cord.
- If the power cord must be wired together with the input/output (I/O) signal lines, use shielded lines and ground one end of the shield to the PL unit's FG terminal.
- To improve noise immunity, Pro-face recommends that you attach a ferrite core to the power cord.

## 10 Backlight Replacement

The PL unit's backlight can be changed after it wears out. When changing the backlight, please refer to the backlight's Installation Guide or the PL-5910 Series User Manual.



**Note:** Please use the following table to identify which backlight model number to use when ordering your backlight.

PL Model	Backlight Model Number
PL- 5910T	GP577RT-BL00-MS
PL- 5911T	

\*1 Use a grounding resistance of less than 100Ω and a 2mm<sup>2</sup> or thicker wire, or your country's applicable standard. For details, contact your local PL distributor.