

Pro-face

by **Schneider** Electric

SP5000 Series Open Box Reference Manual



The information provided in this documentation contains general descriptions and/or technical characteristics of the performance of the products contained herein. This documentation is not intended as a substitute for and is not to be used for determining suitability or reliability of these products for specific user applications. It is the duty of any such user or integrator to perform the appropriate and complete risk analysis, evaluation and testing of the products with respect to the relevant specific application or use thereof. Neither Pro-face nor any of its affiliates or subsidiaries shall be responsible or liable for misuse of the information that is contained herein. If you have any suggestions for improvements or amendments or have found errors in this publication, please notify us.

No part of this document may be reproduced in any form or by any means, electronic or mechanical, including photocopying, without express written permission of Pro-face.

All pertinent state, regional, and local safety regulations must be observed when installing and using this product. For reasons of safety and to help ensure compliance with documented system data, only the manufacturer should perform repairs to components.

When devices are used for applications with technical safety requirements, the relevant instructions must be followed.

Failure to use Pro-face software or approved software with our hardware products may result in injury, harm, or improper operating results.

Failure to observe this information can result in injury or equipment damage.

Copyright © 2017 Digital Electronics Corporation. All Rights Reserved.

Table of Contents



	Safety Information	5
	About this Manual	7
Chapter 1	Overview	9
	Main Features	10
	Operating System and Main Applications	11
	Development Workflow	13
Chapter 2	Launcher	15
	About the Launcher	16
	Normal Window	18
	Custom Window	19
	Startup Window	21
	Setting Window	22
Chapter 3	Environmental Settings	25
	Calibration Setting	26
	Backlight Brightness Setting	27
	Front USB Setting	28
	Dual Display Setting	29
	UART Setting (Communication Settings)	30
	System Version Information	31
	Task Changer Setting	32
	Other Environmental Settings	35
	Other Restrictions	36
Chapter 4	System Operations	39
	Power	40
	Eject	41
	Write Filter	42
	HORM	43
	Shell	44

Safety Information



Important Information

NOTICE

Read these instructions carefully, and look at the equipment to become familiar with the device before trying to install, operate, or maintain it. The following special messages may appear throughout this documentation or on the equipment to warn of potential hazards or to call attention to information that clarifies or simplifies a procedure.



The addition of this symbol to a “Danger” or “Warning” safety label indicates that an electrical hazard exists which will result in personal injury if the instructions are not followed.



This is the safety alert symbol. It is used to alert you to potential personal injury hazards. Obey all safety messages that follow this symbol to avoid possible injury or death.

DANGER

DANGER indicates a hazardous situation which, if not avoided, **will result in death** or serious injury.

WARNING

WARNING indicates a hazardous situation which, if not avoided, **could result in death** or serious injury.

CAUTION

CAUTION indicates a hazardous situation which, if not avoided, **could result in minor or moderate injury**.

NOTICE

NOTICE is used to address practices not related to physical injury.

PLEASE NOTE

Electrical equipment should be installed, operated, serviced, and maintained only by qualified personnel. No responsibility is assumed by Pro-face for any consequences arising out of the use of this material.

A qualified person is one who has skills and knowledge related to the construction and operation of electrical equipment and its installation, and has received safety training to recognize and avoid the hazards involved.

About this Manual



At a Glance

Document Scope

This manual describes how to use the SP5000 Series Open Box ("this product" below).

Validity Note

This documentation is valid for this product.

The technical characteristics of the device(s) described in this manual also appear online at <http://www.pro-face.com>.

The characteristics presented in this manual should be the same as those that appear online. In line with our policy of constant improvement we may revise content over time to improve clarity and accuracy. In the event that you see a difference between the manual and online information, use the online information as your reference.

Registered Trademarks

Microsoft, Windows, Internet Explorer, Office, Excel, and Aero are registered trademarks of Microsoft Corporation in the United States and/or other countries.

Intel is a registered trademark of Intel Corporation.

SkyPDF is a registered trademark of Skycom Corporation.

Product names used in this manual may be the registered trademarks owned by the respective proprietors.

Related Documents

You can download the manuals related to this product, such as the software manual, from our support site <http://www.pro-face.com/trans/en/manual/1001.html>.

Chapter 1

Overview

Introduction

This chapter describes the software and system development workflow for this product.

What Is in This Chapter?

This chapter contains the following sections:

Topic	Page
Main Features	10
Operating System and Main Applications	11
Development Workflow	13

Main Features

This product's features are described below.

Multilanguage Support

This product's operating system supports English (factory setting), Japanese, Spanish, French, German, and Italian. Change the operating system language as required (*see page 35*).

Other languages are available for installation. For additional language support, refer to our support site <http://www.pro-face.com/trans/en/manual/1001.html>.

Write Filter

This function prevents write operations to the CFast system card, enabling you to power off the product without shutting down the operating system (*see page 42*).

HORM (Hibernate Once/Resume Many)

This function shortens the startup time after a shutdown by restoring the system to its state before the shutdown (*see page 43*).

Launcher

This utility displays icons for simple touch operation of files and programs that you can define in advance (*see page 16*).

Password Settings

Setting passwords enhances security by restricting access to operations. You can password-protect individual pages in the Launcher (*see page 22*).

Change Shell

Changing from the Explorer Shell to a Custom Shell enhances security and prevents issues such as altered settings and duplicated applications (*see page 44*).

Operating System and Main Applications

The following describes the product's system parameters.

Hardware Specifications

	SP-5B40	SP-5B41
Operating System	Windows® Embedded Standard 7 with Service Pack 1*1	
CPU	Intel Atom E6x0 1.3 GHz (Single core/Dual thread)	Intel Atom Processor E3825 1.33 GHz (Dual core/Dual thread)
L2 Cache Memory	512 KB	1 MB
Main Memory	DDR2 SDRAM 2 GB	DDR3L SDRAM 2 GB
Video Memory	64 MB maximum (UMA main memory)	256 MB maximum (UMA main memory)

*1 **Windows® Update** is disabled in the factory settings. If updating is required, enable **Windows® Update**.

Installed Applications

The following applications are installed on this product.

- HMI Runtime*1
- Windows® Internet Explorer®
- Windows® Media Player
- Microsoft® .NET Framework 4
- Microsoft® Office® Excel® Viewer 2003
- Microsoft® Office® Word Viewer 2003
- SkyPDF® Viewer

*1 HMI Runtime is a Pro-face application that runs the screen data you create with screen editing software.

Special Utilities

The following is a list of Pro-face utilities available on this product.

Utility	Description	Reference
Launcher	This application provides a single access point to necessary programs for this product. You can define what programs to include.	Chapter 2 Launcher (see page 15)
Calibration Setting	Calibrates the touch coordinates.	Chapter 3 Environmental Settings (see page 25)
Backlight Brightness Setting	Adjusts the Display Module brightness.	
Front USB Setting	Enables/disables the front USB port.	
Dual Display Setting*1	Sets up a dual display.	
UART Setting (Communication Setting)	Defines the serial interface communication settings.	
System Version Information	Displays the version of the product firmware, BIOS, and operating system.	
Task Changer Setting	Lists the current tasks.	

*1 Displays on the Launcher for SP-5B40 only.

Utility	Description	Reference
Power	Runs the following operations: Shutdown, Reboot, and Hibernation.	Chapter 4 System Operations (see page 39)
Eject	Enables you to remove devices.	
Write Filter	Enables/disables the Write Filter.	
HORM	Enables/disables HORM (Hibernate Once/Resume Many).	
Shell	Shows/hides the Windows® desktop.	

Development Workflow

This section describes the workflow for system development.

NOTE: The factory setting of the operating system language is English. Change the operating system language as required (see page 35).

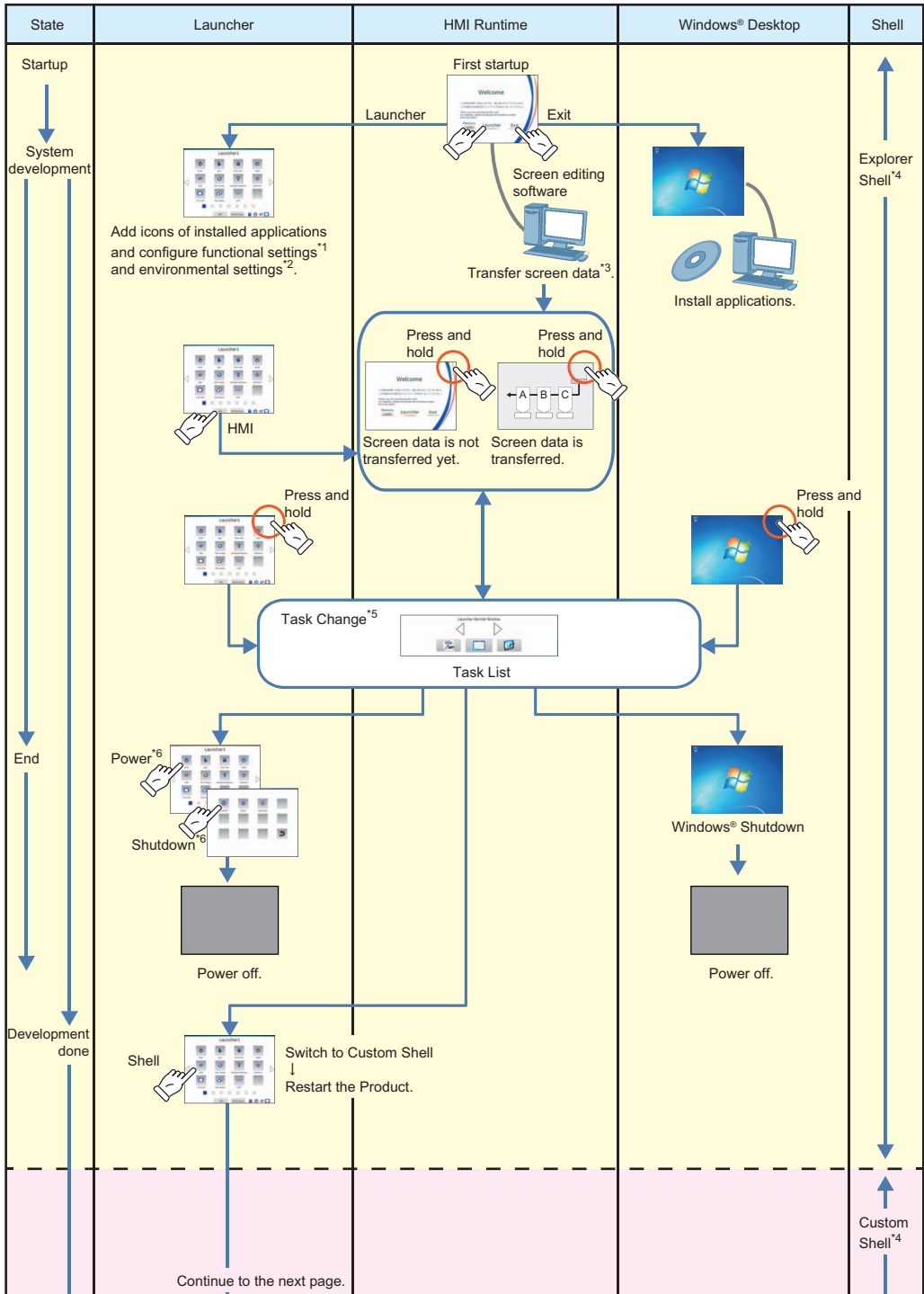

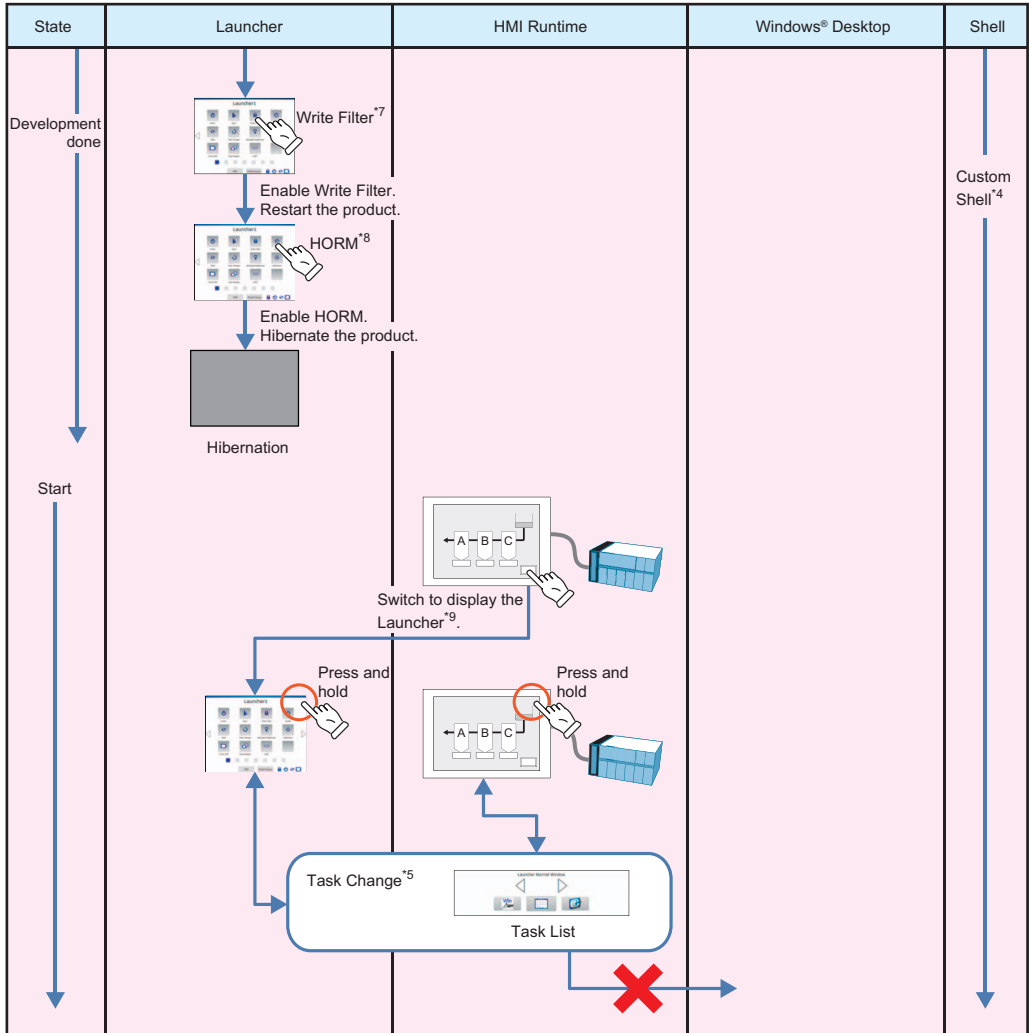

*1 Chapter 2: Launcher (see page 15)

*2 Chapter 3: Environmental Settings (see page 25)

*3 Refer to your screen editing software manual.

*4 Chapter 4: System Operations - Shell (see page 44)

*5 Chapter 3: Environmental Settings - Task Changer Setting (see page 32)

*6 Chapter 4: System Operations - Power (see page 40)

*7 Chapter 4: System Operations - Write Filter (see page 42)

*8 Chapter 4: System Operations - HORM (see page 43)

*9 You can use the screen editing software to create a switch that displays the Launcher. Refer to your screen editing software manual for instructions.

NOTE: During normal operation of this product, we recommend that you have the Write Filter, HORM, and Custom Shell enabled at all times.

Chapter 2

Launcher

Introduction

This chapter describes the features of the Launcher.

What Is in This Chapter?

This chapter contains the following sections:

Topic	Page
About the Launcher	16
Normal Window	18
Custom Window	19
Startup Window	21
Setting Window	22

About the Launcher

Introduction

The Launcher is a utility that displays icons of files, programs, and settings that you designate in advance. It allows for convenient touch-screen operation.

The Launcher is used in Normal Mode during normal operation. Use Custom Mode to add programs and to change the Launcher screen configurations, startup settings, and passwords.

The following describes the different modes.

Normal Mode

The Normal Window is displayed in this mode, which is where you use this utility.

Change to Custom Mode by using the **ModeChange** button.

Normal Window:

In this window, start files and programs by touching their icons.

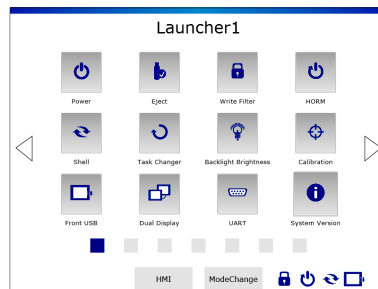

Custom Mode

Use this mode to change the Launcher screen configuration, startup settings, and passwords.

There are three windows in this mode, as described below. Touch **Exit** to return to Normal Mode.

Custom Window:

Add, delete, and move programs, as well as lock pages.

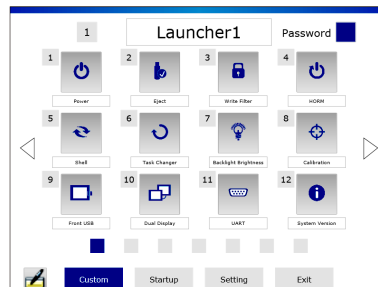

Startup Window:

Define the programs you want to start automatically when the operating system starts up, and set the order in which these programs start.

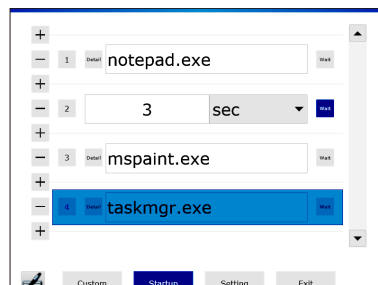

Setting Window:

Set passwords for toggling between modes and changing pages, set the number of pages in the Launcher, and set whether or not to use animation in the Launcher.

The screenshot shows a software settings window with the following elements:

- Mode Change Password** (selected)
- Page Change Password**
- Launcher Page Number**
- Animation**
- Password**: ON
- Effective Time**: 10 min
- Security Level**: Low
- Delete Password** button
- Current Password** field
- New Password** field
- Re-entry of New Password** field
- Navigation bar: Custom, Startup, **Setting**, Exit

Normal Window

Description of the Normal Window

Press and hold the top-right corner of the screen to display the Task List Window, and touch the **Launcher** icon to display the Launcher.

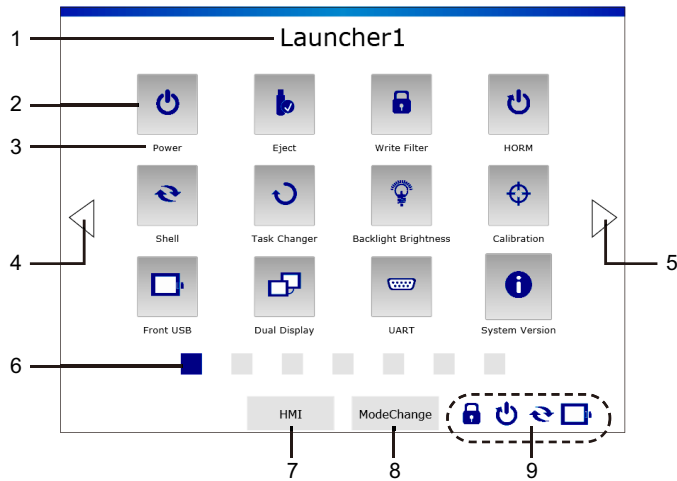

No.	Name	Description
1	Title	The title of the page that is displayed.
2	Program button	The icon for the program.
3	Program name	The name of the program.
4	Previous button	Displays the previous page.
5	Next button	Displays the next page.
6	Page number button	Shows the currently displayed page. Can also be used to switch to another page.
7	HMI button	Displays the HMI Runtime.
8	ModeChange button	Changes to Custom Mode.
9	System status	Shows if the following features are enabled or disabled: Write Filter, HORM, Shell, Front USB.

Custom Window

Description of the Custom Window

To change to this window, touch the **ModeChange** button at the top of the Launcher's Normal Window.

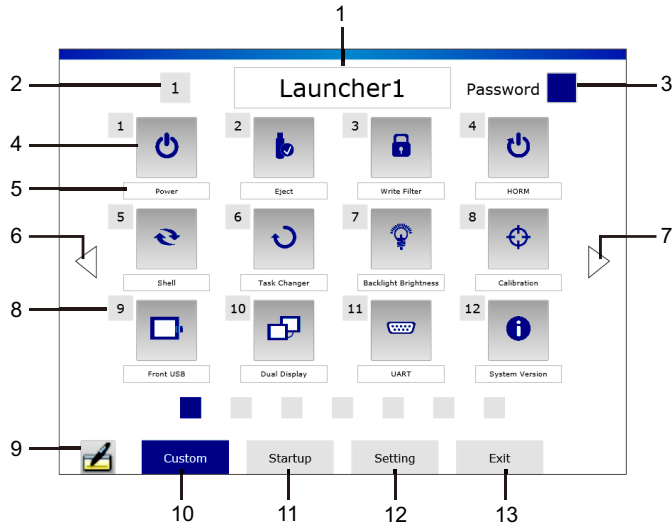

No.	Name	Description
1	Title textbox	Enter the page title here.
2	Page Select button	Select this when moving the contents of the entire page to another page.
3	Password button	Locks/unlocks the page. If the page change password is not set and you touch the Password button, the Password Setting screen is displayed (see page 22).
4	Program button	Add/delete programs (see page 20).
5	Program Name textbox	Enter the program name here.
6	Previous button	Displays the previous page.
7	Next button	Displays the next page.
8	Program Select button	Select this when moving a program to another position (see page 20).
9	Keyboard button	Displays the keyboard.
10	Custom button	Displays the Custom Window (see page 19).
11	Startup button	Displays the Startup Window (see page 21).
12	Setting button	Displays the Setting Window (see page 22).
13	Exit button	Returns to Normal Mode.

Adding Programs

Touch an open button.

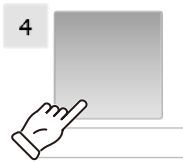

Select the program.

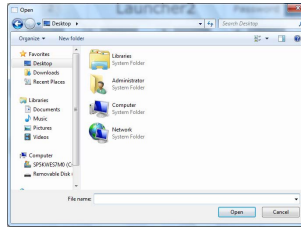

Enter the program name.



NOTE: If the screen below is displayed after you select a program, you can select whether or not the program is always displayed on top.

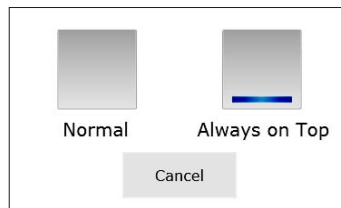

Deleting Programs

Touch the button.



Press **OK** to delete.

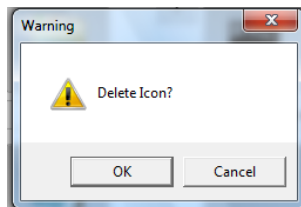

NOTE: Programs that were installed in the factory cannot be deleted.

Moving Programs

Touch the Program Select button.

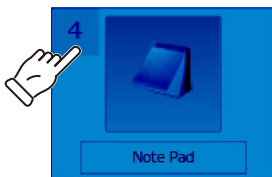

Touch the destination Program Select button.

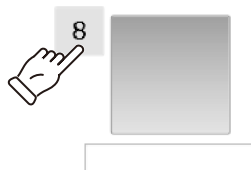

Move complete.



NOTE: If a program already exists in the destination, the existing program trades places with the program you are moving.

Startup Window

Startup Setting

Startup is a feature that allows you to automatically start specified programs when the operating system starts.

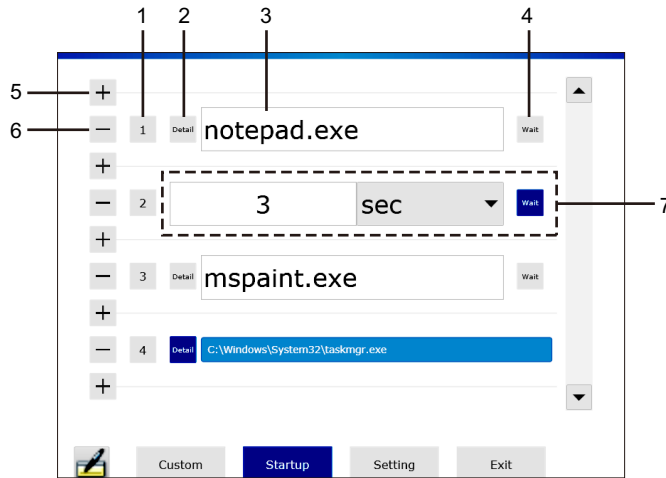

No.	Name	Description
1	Number button	Select this when changing the order for starting programs.
2	Detail button	Displays the location (path) of the selected program.
3	Program Setting box	Touch this to select the program. The selected program name is displayed. If the Wait button is enabled, the Wait Time Setting box is displayed.
4	Wait button	Switches between the Program Setting box and the Wait Time Setting box.
5	Add button	Adds a Program Setting / Wait Time Setting box
6	Delete button	Deletes a Program Setting / Wait Time Setting box.
7	Wait Time Setting box	Sets the wait time from the start of a program to the start of the next program. The unit can be set to [sec] or [msec]. If the Wait button is disabled, the Program Setting box is displayed.

Changing the Starting Order

Touch the Number button.

Touch the Number button of the destination box.

Order change complete.

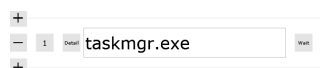
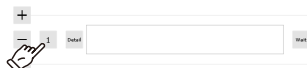

NOTE: If a program/wait time already exists in the destination, the existing program/wait time trades places with the program/wait time you are moving.

Setting Window

Setting the Mode Change Password

Set the password that must be entered when switching from Normal Mode to Custom Mode.

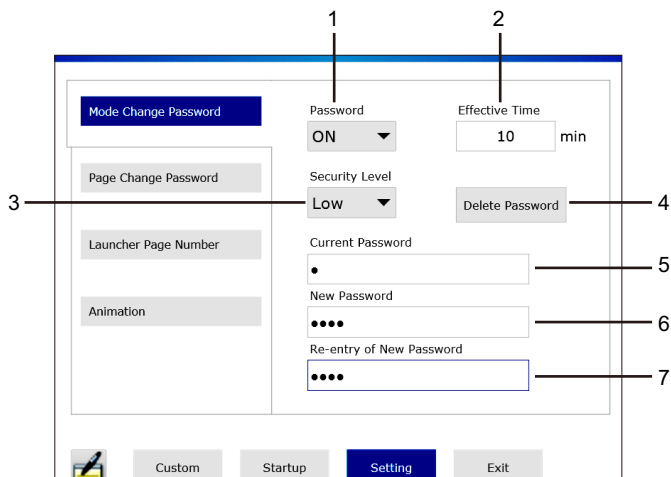

No.	Name	Description
1	Password ON/OFF	Enable/disable the password.
2	Effective Time	After the password is entered, the screen returns automatically to the Normal Window when this set time elapses if you do not perform any screen operations.
3	Security Level	High and Low have different requirements for the number of character types and the number of characters that can be used. High: From the usable characters below, at least 4 types and at least 8 characters are required. Low: From the usable characters below, at least 1 type and at least 1 character is required. Usable characters Lowercase letters: a to z Uppercase letters: A to Z Numbers: 0 to 9 Characters: !"#%&'()*+,-.:/<=>?@[^_`{ }~
4	Delete Password button	Deletes the password.
5	Current Password	Enter your current password. This is displayed only when a password has been set.
6	New Password	Enter your new password here.
7	Re-entry of New Password	Re-enter your new password.

NOTE: Do not forget your password. Without your password, you cannot switch to Custom Mode and change various settings.

Setting the Page Change Password

Set the password that must be entered when switching to a locked page in the Normal Window.

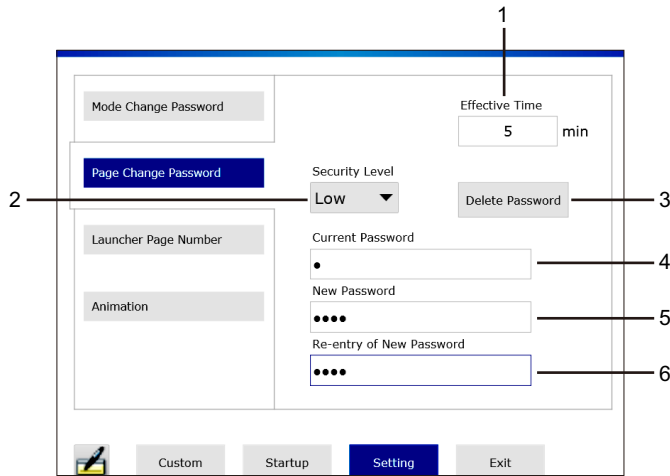

No.	Name	Description
1	Effective Time	After a locked page is opened, the screen returns automatically to the Normal Window when this set time elapses if you do not perform any screen operations.
2	Security Level	High and Low have different requirements for the number of characters types that can be used, and on the number of characters. High: From the usable characters below, at least 4 types and at least 8 characters are required. Low: From the usable characters below, at least 1 type and at least 1 character is required. Usable characters Lowercase letters: a to z Uppercase letters: A to Z Numbers: 0 to 9 Characters: !"#%&'()*+,-.:/<=>?@[\\]^_`{ }~
3	Delete Password button	Deletes the password.
4	Current Password	Enter your current password. This is displayed only when a password has been set.
5	New Password	Enter your new password here.
6	Re-entry of New Password	Re-enter your new password.

NOTE:

- To lock a page, in the Custom Window, touch the **Password** button for the page in question (see page 19).
- Do not forget your password. Without your password, you cannot display the locked page.

Setting the Launcher Page Number

Set the number of pages in the Launcher. Up to 7 pages can be set.

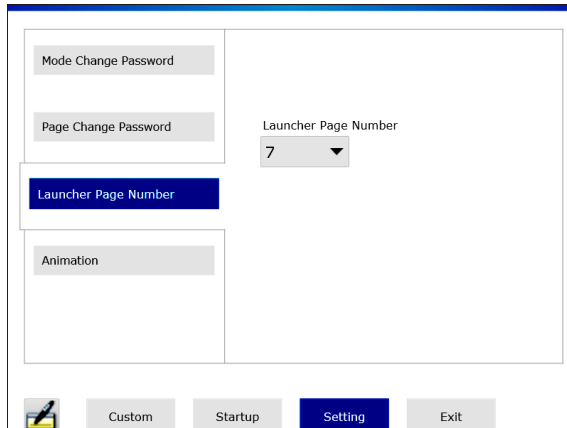

Setting the Animation

Enable and disable the animation used in the Launcher.

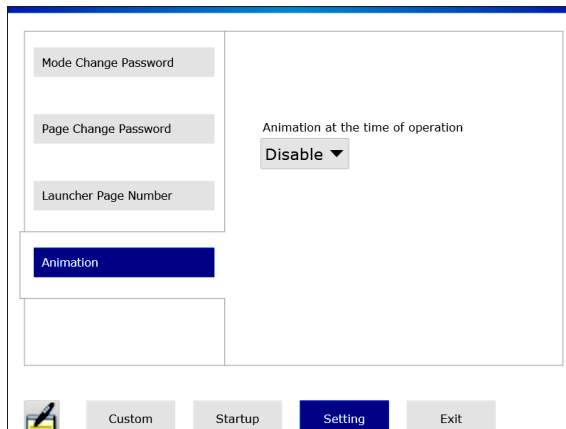

Chapter 3

Environmental Settings

Introduction

This chapter describes the environmental settings for this product.

What Is in This Chapter?

This chapter contains the following sections.

Topic	Page
Calibration Setting	26
Backlight Brightness Setting	27
Front USB Setting	28
Dual Display Setting	29
UART Setting (Communication Settings)	30
System Version Information	31
Task Changer Setting	32
Other Environmental Settings	35
Other Restrictions	36

Calibration Setting

Introduction

Calibrates the display (touch panel).

You can change this setting from either the Launcher or the Control Panel.

Changing the Setting from the Launcher

In the Launcher, touch the **Calibration** icon and perform the calibration following the on-screen instructions.

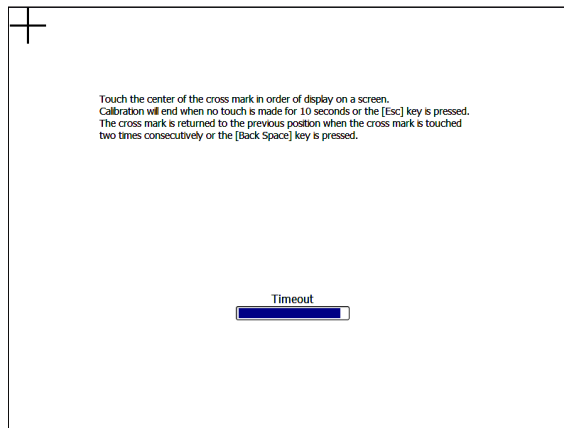

Changing the Setting from the Control Panel

Control Panel → **Hardware and Sound** → **Display Module Calibration**

NOTE: Do not use [Adjustment] in **Control Panel** → **Hardware and Sound** → **Tablet PC Settings**. You will not be able to properly calibrate the touch coordinates.

Backlight Brightness Setting

Introduction

Adjusts the backlight brightness.

You can change this setting from either the Launcher or the Control Panel.

NOTE: When the DC Power Supply Adapter for Box Module is attached, this setting becomes invalid.

Changing the Setting from the Launcher

In the Launcher, touch the **Backlight Brightness** icon, and adjust the brightness.

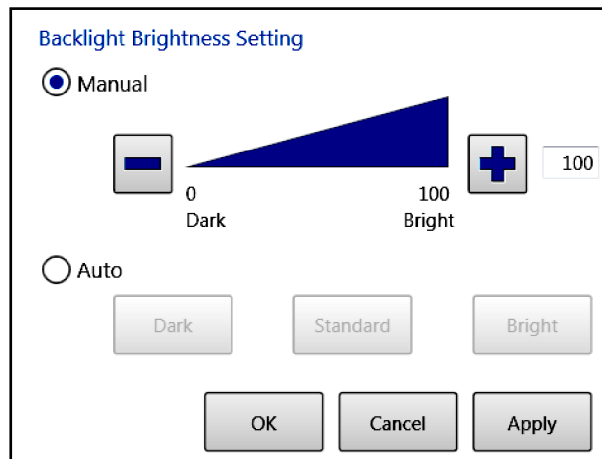

Manual: Sets the brightness to a fixed value from 0 to 100.

Auto: Automatically adjusts the brightness to the selected level using a brightness sensor.

Changing the Setting from the Control Panel

Control Panel → **Hardware and Sound** → **Backlight Brightness Setting**

NOTE: You cannot change the backlight brightness from the following locations:

- **Control Panel** → **Hardware and Sound** → **Power Options** → **Screen brightness**
- **Control Panel** → **Hardware and Sound** → **Power Options** → **Choose when to turn off the display** → **Adjust plan brightness**

Front USB Setting

Introduction

Enables/disables the front USB.

You can change this setting from either the Launcher or the Control Panel.

NOTE: In models without a front USB, this setting is disabled.

Changing the Setting from the Launcher

In the Launcher, touch the **Front USB** icon, and enable/disable the setting.

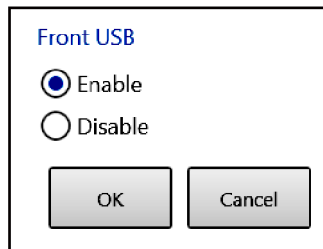

Changing the Setting from the Control Panel

Control Panel → Hardware and Sound → Front USB Setting

Dual Display Setting

Introduction

Sets the display method.

You can change this setting from either the Launcher or the Control Panel.

NOTE: On the SP-5B41, set up is possible only from the Control Panel.

Changing the Setting from the Launcher

In the Launcher, touch the **Dual Display** icon, and set the display method.

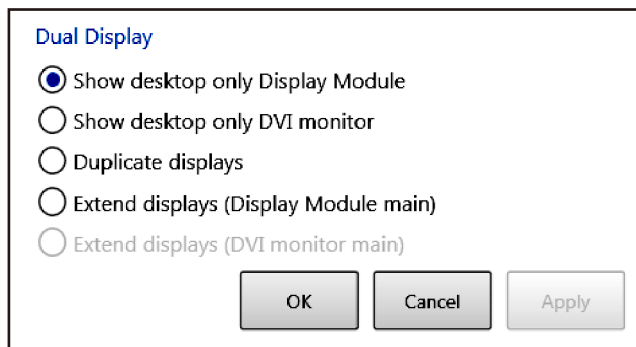

Changing the Setting from the Control Panel

For SP-5B40: **Control Panel** → **Hardware and Sound** → **Dual Display Setting**

For SP-5B41: **Control Panel** → **Appearance and Personalization** → **Display** → **Adjust resolution**

NOTE:

The following notes are only for SP-5B40:

- If you change [Multiple Displays] to [Extend these displays] in **Control Panel** → **Appearance and Personalization** → **Display** → **Adjust resolution**, the DVI monitor will be set as the main display even when it is not connected. To change the display method, always use **Dual Display** in the Launcher.
- When using the SP-5500WA (10.1-inch wide display) or SP-5600WA (12.1-inch wide display) connected to a DVI monitor, you cannot select clone mode [Duplicate displays]. When connecting a DVI monitor, use extended desktop [Extend displays].
- When you first connect a monitor to the DVI port and change to the extended desktop setting, a dialog box to confirm the setting change may be displayed on the DVI monitor. Enable the setting change on the DVI monitor.
- In the **Dual Display** setting, you cannot use [Show desktop only DVI monitor].

UART Setting (Communication Settings)

Introduction

Sets the COM1/COM2 communication settings.

You can change this setting from either the Launcher or the Control Panel.

Changing the Setting from the Launcher

In the Launcher, touch the **UART** icon, and set the communication method.

UART Setting

COM1 COM2

RS232C Vcc / RI Vcc RI
 RS422 / 485 2 / 4 Wire 2 Wire 4 Wire
 Echo cancel Enable Disable

Baudrate: 115200 bps
 Stop bit: 1 bit
 Parity bit: None
 Data length: 8 bit

OK Cancel Apply

Changing the Setting from the Control Panel

Control Panel → Hardware and Sound → UART Setting

NOTE:

- When you use the COM1 or COM2 port for an application, you can only use the port that is not used by the HMI Runtime. Also, the communication settings shown in the above figure must be consistent with the communication settings for that application.
- The following note is only for SP-5B40:
 - For COM2, there may be instances when the control signal response is significantly delayed. COM2 cannot be used for real-time control. Use COM1 when you require signal response for real-time control.

System Version Information

Introduction

Displays the version of the product firmware, BIOS, and operating system.

Display on the Launcher

On the Launcher, touch the **System Version** icon to display the information.

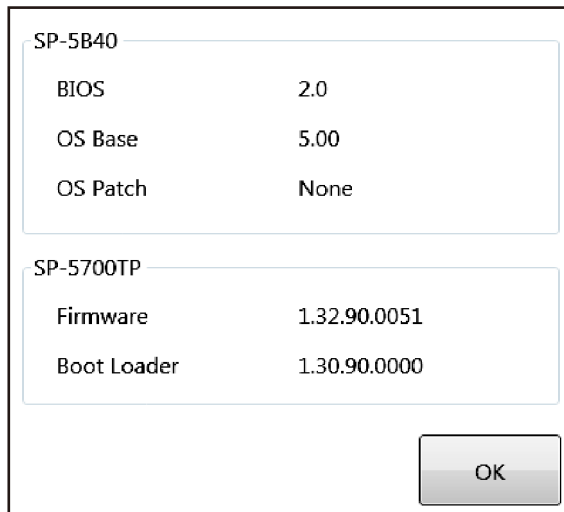

Task Changer Setting

Introduction

Press and hold the top-right corner of the screen to display the Task List window to change between tasks.

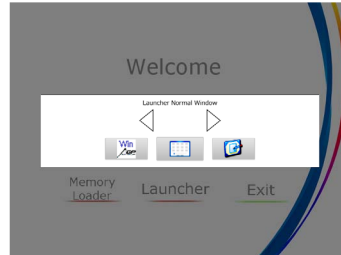

NOTE: To display the Task List, you can also press and hold the top-right corner of a DVI monitor connected in the extended desktop setting.

Task List Window

To display the Task List window, touch the **Task** button in the **Task Changer** window, or touch and hold the top-right corner of the screen.

The Task List window shows the current tasks.

Select a task that you want to display, and the screen will change to this task.

NOTE: The position to press and hold can be set to any corner of the screen (see page 34).

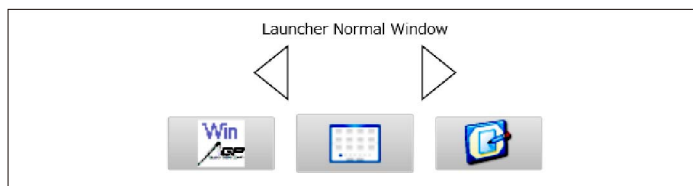

Task Changer Window

Touch the **Task Changer** icon on the Launcher to display the **Task Changer** window.

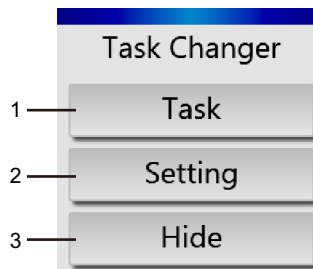

No.	Name	Description
1	Task button	Displays the Task List window.

No.	Name	Description
2	Setting button	Displays the Setting window. In the Setting window, you can change the settings for Task Changer operations.
3	Hide button	Hides the Task Changer window.

Task Changer Setting Window

Change settings for **Task Changer** operations.

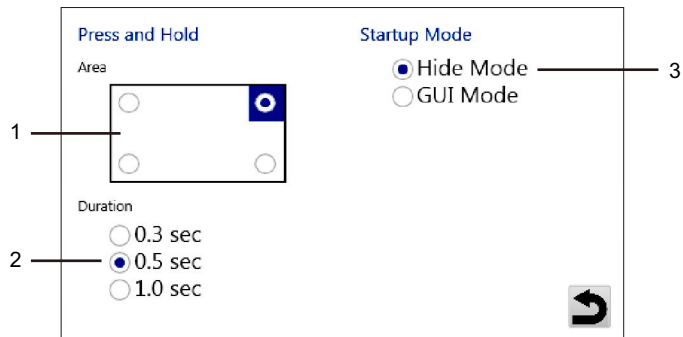

No.	Name	Description
1	Press and Hold Area	Choose the corner where to press and hold.
2	Press and Hold Duration	Choose how long to touch the press and hold area to display a complete circle.
3	Startup Mode	Hide Mode: The Task Changer window is not displayed when the Launcher is started. GUI Mode: The Task Changer window is displayed when the Launcher is started.

Other Environmental Settings

Introduction

The other environmental settings can be changed in the Control Panel.

Network Settings

Control Panel → Network and Internet → Network and Sharing Center

Language Settings

For details on changing the operating system language, refer to the following URL.

<http://www.pro-face.com/trans/en/product/1017.html>

Time Settings

Control Panel → Clock, Language, and Region → Date and Time

NOTE: The RTC installed in this product is an external RTC. After changing the clock setting, restart or shut down the operating system.

Audio/Speaker Settings

Control Panel → Hardware and Sound → Sound

Other Restrictions

Introduction

This product was factory-configured to maintain optimal performance as an HMI. Changing the settings may lead to the loss of performance as an HMI.

Read the restrictions below, and use this product in an appropriate environment.

User Account

If you change the login account from the factory setting of [Administrator] to another account, the **User Account Control** dialog box may be displayed while you use this product. Depending on how you operate the **User Account Control** dialog box, this product may not operate properly. Do not use a login account other than [Administrator].

Theme Settings (SP-5B40 only)

The [Change the theme] option in **Control Panel** → **Appearance and Personalization** → **Personalization** is disabled. Use the factory-set theme.

Displaying Standard Windows® Dialog Boxes for the SP-5400WA (7.0-inch Wide Display)

Because the resolution of the SP-5400WA is WVGA (800 x 480), some standard Windows® dialog boxes may not display the **OK/Cancel/Apply** buttons, preventing the user from touching them.

If this happens, connect the DVI monitor as an extended desktop and display the dialog boxes on the DVI monitor so that you can operate them.

Resolution on the SP-5500TP (10.4-inch Display) (SP-5B40 only)

The resolution of the SP-5500TP is SVGA (800 x 600). Although the resolution recommended in **Control Panel** → **Desktop** → **Display** → **Screen Resolution** is XGA (1024 x 768), using this resolution will shrink the screen and distort the display.

Be sure to use the factory setting of SVGA (800 x 600).

VGA (640 x 480) Support on SP-5B41

When using the SP-5B41, follow the steps below to change the resolution to VGA (640 x 480).

1. From **Control Panel** → **Appearance and Personalization** → **Display** → **Adjust resolution**, touch **Advanced settings**.
2. From the **Adapter** tab, touch **List All Modes**.
3. Select the **VGA (640 x 480)** mode.
4. Touch OK.

If you follow these steps and change the display to VGA (640 x 480), some standard Windows® dialog boxes may not display the **OK/Cancel/Apply** buttons, preventing the user from touching them. If this happens, connect the DVI monitor as an extended desktop and display the dialog boxes on the DVI monitor so that you can operate them.

NOTE: The HMI runtime does not support VGA.

Rotating the Screen When Using Extended Desktop (SP-5B40 only)

When you use a DVI monitor connected as an extended desktop, only [Normal] is available for setting rotation in the graphics options.

Receiving Jumbo Frames Through an Ethernet Interface (Ethernet2) (SP-5B40 only)

If jumbo frames are received when Ethernet2 jumbo frames are disabled, the BSOD (Blue Screen of Death) will occur. For this reason, this product is shipped with jumbo frames for Ethernet2 enabled. If you disable Ethernet2 jumbo frames, set the peripheral devices so that jumbo frames are not sent through the network.

Press and Hold as Right Click

When this product is shipped, [Enable Press and hold for right clicking] is disabled in **Control Panel** → **Hardware and Sound** → **Pen and Touch** → **Touch** → **Press and Hold** → **Settings**.

Make sure this setting is disabled, or else press and hold for **Task Changer** will not function correctly.

Removeable Media AutoPlay

You cannot enable **AutoPlay** for removable media.

Device Manager

Special settings unique to this product have been set in **Control Panel** → **System and Security** → **System** → **Device Manager**. Do not change the factory settings.

Services Settings

Special settings unique to this product have been set in **Control Panel** → **System and Security** → **Administrative Tools** → **Services**. Do not change the factory settings.

Task Scheduler Settings

Special settings unique to this product have been set in **Control Panel** → **System and Security** → **Administrative Tools** → **Task Scheduler**. Do not change the factory settings.

Software Keyboard

You can only use the software keyboard with the main display. This is a standard specification of Windows® 7.

When you want to start the software keyboard from the Launcher, first show the Launcher on the main display using the **Task Changer**.

Screen Saver

If **Turn off the display** is enabled in **Control Panel** → **Hardware and Sound** → **Power Options** → **Choose when to turn off the display**, and a screen saver is also enabled, when you perform a touch operation with the display power off, incorrect operation may result.

When **Turn off the display** is enabled, in **Control Panel** → **Appearance and Personalization** → **Personalization** → **Screen Saver**, set **Screen Saver** to [None].

Chapter 4

System Operations

Introduction

This chapter describes the system operations for this product.

What Is in This Chapter?

This chapter contains the following sections.

Topic	Page
Power	40
Eject	41
Write Filter	42
HORM	43
Shell	44

Power

Introduction

Operates the power for the product.

Power Window

Touch the **Power** icon on the Launcher to select a power-related operation.

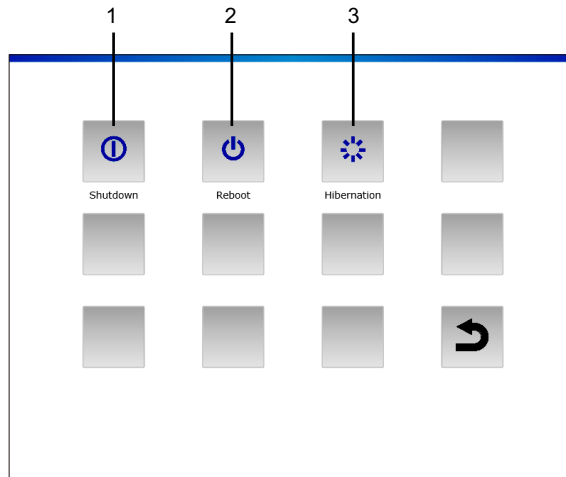

No.	Name	Description
1	Shutdown	Shuts down the operating system.
2	Reboot	Reboots the operating system.
3	Hibernation	Hibernates the operating system.

NOTE:

- When you hibernate the operating system using the **Hibernation** icon with HORM enabled, the current system state overwrites the state previously saved in HORM. When you reboot the system, the system starts in this state saved at hibernation. After that, even if the power is shut off with HORM enabled, the system returns to this state saved at hibernation.
- This system is set to [High Performance] in **Control Panel** → **Hardware and Sound** → **Power Options** → **Select a power plan** → **Preferred plans**. Do not change this setting because this may affect performance.

Eject

Introduction

Enables storage devices (not including the CFast card) to be removed.

NOTICE

Loss of Data

- While storage devices are accessed, do not turn off or reset this product, and do not insert or remove the storage devices.
- When removing storage devices (not including the CFast card) from this product, always use the Eject command from the Launcher or the Windows® Safely Remove Hardware feature.
- Turn off this product when inserting or removing the CFast card.

Failure to follow these instructions can result in equipment damage.

Eject Window

Touch the **Eject** icon on the Launcher, and choose the storage device you want to remove.

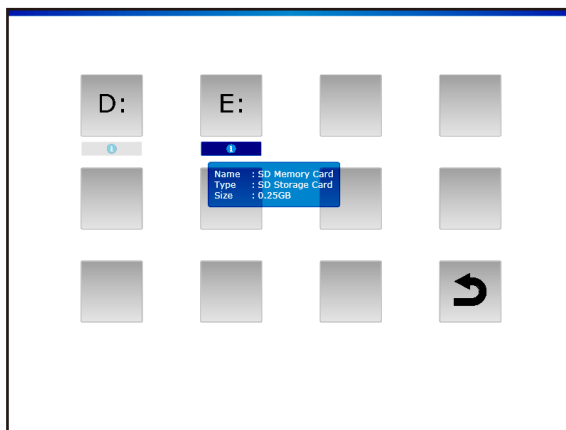

NOTE: The drive letter of the storage device depends on the order in which it was inserted. Check the drive letter before removing the device.

Write Filter

Introduction

This function prevents writing to the CFast system card.

By enabling the Write Filter, you can prevent damage to the CFast system card and shorted life due to excessive writes. Also, enabling the Write Filter allows you to turn off the power to this product without shutting it down.

NOTICE

Loss of Data

Do not turn off the power while writing to a storage device that is not protected by the Write Filter.

Failure to follow these instructions can result in equipment damage.

NOTE:

- The Write Filter is disabled when the product is shipped.
- Normally, have the Write Filter enabled to reduce the number of writes to the CFast system card.
- When changing settings (such as the settings in the Launcher and Control Panel, and when adding drivers, changing the registry, installing applications, transferring screen data to the HMI Runtime), always ensure that the Write Filter is disabled. If the Write Filter is enabled, the setting information will be erased when the operating system is rebooted. After you change the setting, we recommend that you re-enable the Write Filter.

Write Filter Window

Touch the **Write Filter** icon to enable/disable the Write Filter. Enabling the Write Filter causes the system to restart.

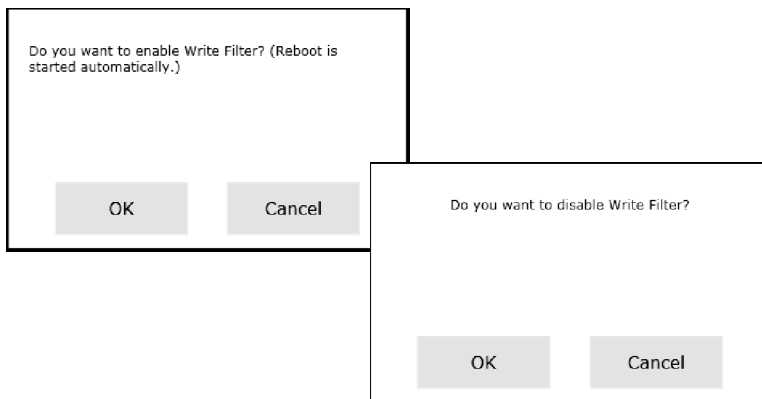

HORM

Introduction

This feature shortens the product's restart time.

If you save a system state with HORM enabled, it is possible to restore the system to this saved state even after the power to this product is cut off.

If HORM is enabled, it is necessary to enable the Write Filter as well. By doing so, you can turn off the power to this product without performing a shutdown.

NOTICE

Loss of Data

Do not turn off the power while writing to a storage device that is not protected by the Write Filter.

Failure to follow these instructions can result in equipment damage.

HORM Window

Touch the **HORM** icon on the Launcher to enable/disable HORM.

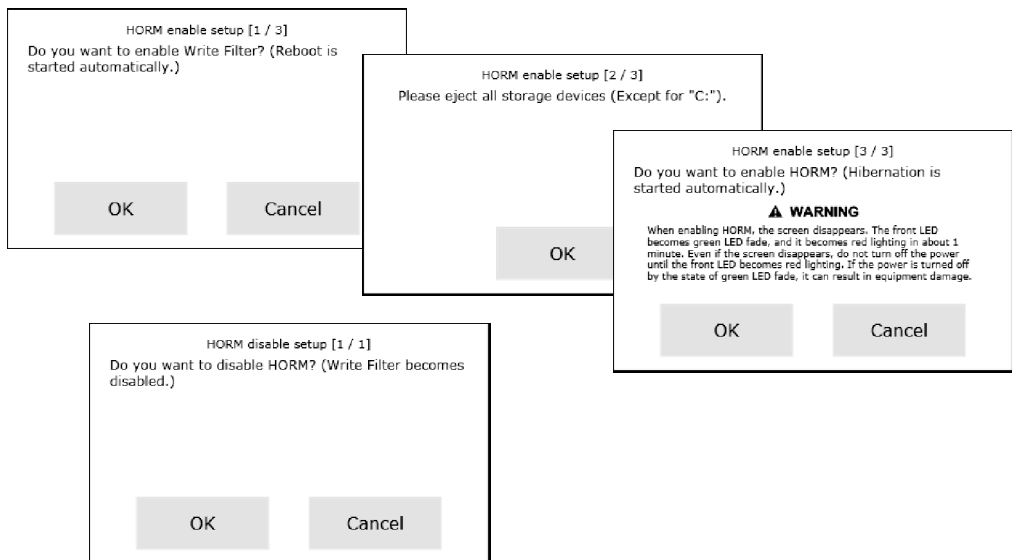

NOTE:

- Before enabling this feature, remove any connected storage devices (*see page 41*).
- If you touch the **HORM** icon when the Write Filter is disabled, a dialog box for enabling the Write Filter appears. To reboot, touch **OK**. However, HORM is not yet enabled. To enable HORM, touch the **HORM** icon again.
- The system cannot be backed up or recovered normally immediately after hibernation or when HORM is enabled. To back up or recover the system, first shut down the computer or disable HORM. (To back up or recover the system, refer to our support site (<http://www.pro-face.com/trans/en/manual/1001.html>). You can also use commercial system-backup software.)
- If the CFast system card has stored the system configured at hibernation or with HORM enabled, do not use the CFast system card with a different Open Box.

Shell

Introduction

By switching from the Explorer Shell to the Custom Shell, you can hide the Windows® desktop and make it look like a dedicated HMI. By doing so, you can prevent settings from being changed and applications from being duplicated, and improve security.

Shell Window

Touch the **Shell** icon on the Launcher to change from the Explorer Shell to the Custom Shell and back. After you change the shell, the system automatically reboots.

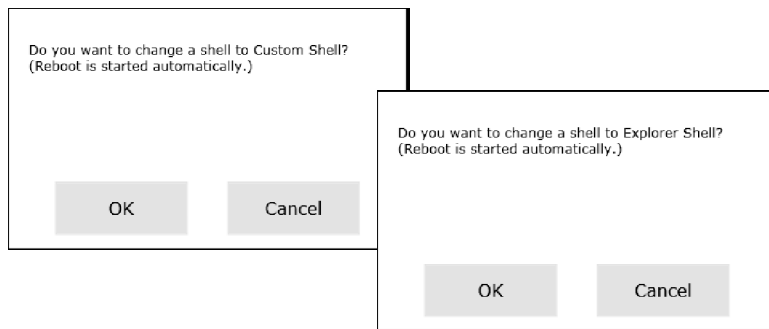

Custom Shell: The Windows® desktop is not displayed.

Explorer Shell: The Windows® desktop is displayed.

NOTE:

- Install applications in the Explorer Shell.
- When the Launcher is displayed, the features shown in the Explorer Shell (such as Windows® desktop, Start menu, taskbar) cannot be used.