

PL-3600K/3700K Series Installation Guide

Caution

Be sure to read the "Warning/Caution Information" on the attached sheet before using the product.

Package Contents

- (1) PL Unit (1)
- (2) Installation Guide (1) <This Guide>
- (3) Warning/Caution Information (1)
- (4) Installation Gasket (Attached to the front module) (1)
- (5) Installation Fasteners (4 fasteners per set)
PL-3600K Series: 2 sets
PL-3700K Series: 3 sets



- (6) USB Cable Clamp (2 ports) (2)



- (7) USB Holder (fasteners: 1, screws: 2) (1 set)



- (8) Power Connector (For AC type or DC type) (1)

For AC type



For DC type



IMPORTANT

- Be careful when installing the PL not to damage the built-in HDD.

This unit has been carefully packed, with special attention to quality. However, should you find anything damaged or missing, please contact your local PL distributor immediately.

When you order a PL unit built to your specifications, that PL package should include each optional item's Installation Guide. Please use that guide to check the contents of each optional item's package.

About the Manual

For the detailed information on PL series, refer to the following manuals.

- PL3000 Series Hardware Manual
 - PL3000 Series Reference Manual
 - PL3000 Series API Reference Manual
- Manual can be downloaded from Pro-face Home Page.

URL <http://www.pro-face.com/otasuke/>

NOTE

- The drivers and utilities for PL can be downloaded from Pro-face Home Page.

Part Names and Functions

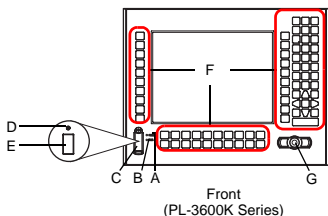

Name		Description	
A	Power LED / RAS status lamp (POWER)	LED	Indicates
		Green (lit)	Normal operation (power is on)
		Green (blinking)	Soft OFF state
		Orange (lit)	System monitor error (RAS error) / Touch Panel Self Test Error
		Orange/Red (blinking)	Backlight burnout is detected.
		Not lit	Power is OFF
B	Disk access lamp (DISK)	LED	Indicates
		Green (lit)	When HDD or IDE is accessed
		Not lit	When neither HDD nor IDE is accessed
C	Front cover	—	
D	Hardware reset switch (RESET)	Resets the PL unit and returns the system from Soft OFF.*1	
E	USB interface	1 port. USB2.0 compatible. Type-A connector is used.	
		Power supply voltage	DC5V±5%
		Output current	500mA (Max.)
		Maximum communication distance	5m
F	Keypad	F/A key allows switching between function entry and character entry. An illuminated F/A key LED indicates character entry. For detailed instruction of how to use the keypad, refer to "PL3000 Series Reference Manual".	
G	Mouse pointer	2-button mouse	

*1 The Soft OFF refers to the state when Windows® has been shut down and the power is provided only for the electric circuit to boot system. This Soft OFF State is different from Windows® System Standby.

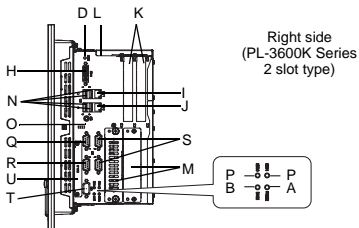

	Name	Description						
H	DVI-I interface (DVI-I)	For analog RGB output only. *1						
I	Ethernet interface (LAN1)	10BASE-T/100BASE-TX/1000BASE-T Auto Changeover. This interface uses an RJ-45 type modular jack connector (8 pins).						
J	Ethernet interface (LAN2)	10BASE-T/100BASE-TX Auto Changeover. This interface uses an RJ-45 type modular jack connector (8 pins).						
K	Expansion slot	For expansion board (PCI). 2 slots or 4 slots.						
L	Expansion slot cover	Expansion slot cover is removed when mounting expansion board and DIM module.						
M	HDD slot	For serial ATA HDD unit. HDD slot 0 and then HDD slot 1 from the left						
N	USB interface (USB1/2/3/4)	4 ports. USB2.0 compatible. Type-A connector is used. <table border="1" style="width: 100%; border-collapse: collapse;"> <tr> <td>Power supply voltage</td> <td>DC5V±5%</td> </tr> <tr> <td>Output current</td> <td>500mA (Max.)</td> </tr> <tr> <td>Maximum communication distance</td> <td>5m</td> </tr> </table>	Power supply voltage	DC5V±5%	Output current	500mA (Max.)	Maximum communication distance	5m
Power supply voltage	DC5V±5%							
Output current	500mA (Max.)							
Maximum communication distance	5m							
O	Speaker output interface (SPK)	Mini pin jack connector						
P	HDD status lamp (HDD0/HDD1)	For HDD0 and for HDD1 from left to right. <table border="1" style="width: 100%; border-collapse: collapse;"> <thead> <tr> <th>LED</th> <th>Indicates</th> </tr> </thead> <tbody> <tr> <td>Green (lit)</td> <td>HDD mounted (Normal operation)</td> </tr> <tr> <td>Not lit</td> <td>No HDD mounted</td> </tr> </tbody> </table>	LED	Indicates	Green (lit)	HDD mounted (Normal operation)	Not lit	No HDD mounted
LED	Indicates							
Green (lit)	HDD mounted (Normal operation)							
Not lit	No HDD mounted							
Q	Serial interface (COM1)	D-Sub 9-pin plug type. RS-232C, RS-422, RS-485 Changeover. CI (RI)/+5V Changeover.						
R	Serial interface (COM2)	D-Sub 9-pin plug type. RS-232C. CI (RI)/+5V Changeover.						
S	Serial interface (COM3/COM4)	D-Sub 9-pin plug type. RS-232C. COM3 and then COM4 from the top						
T	RAS interface (RAS)	D-Sub 9 pin socket type.						
U	CF card interface	IDE-type connection *2 CF card (Type I/II) is available.						

*1 DVI monitor cannot be connected.

*2 Since an IDE-type connection is used, the unit is not hot-swappable. When inserting/removing the CF card, be sure that power is turned OFF.

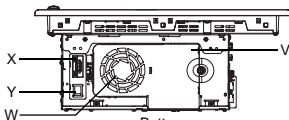

Bottom
(PL-3600K Series 2 slot type)



Top
(PL-3600K Series 2 slot type)

	Name	Description
V	Fan cover	System fan inside
W	System fan	A fan for cooling the PL unit.
X	Power connector	—
Y	Power switch	AC type only.

IMPORTANT

- When attaching peripheral units to the PL, be sure the PL's power cord is disconnected from the main power supply.

General Specifications

■ Electrical Specifications

Power Supply		DC type	AC type
	Input Voltage	DC24V	AC100 to 240V
	Rated Voltage	DC19.2 to 28.8V	AC85 to 264V
	Rated Frequency	—	50/60Hz
	Allowable Frequency Range	—	47 to 63Hz
	Allowable Voltage Drop	5ms or less	1 cycle or less (Voltage drop interval must be 1s or more.)*1
	Power Consumption	145W or less	145VA or less
	In-Rush Current	40A or less	
Voltage Endurance	AC1000V 10mA for 1 minute (between charging and FG terminals)	AC1500V 20mA for 1 minute (between charging and FG terminals)	
Insulation Resistance	DC500V 10MΩ (min.) (between charging and FG terminals)	DC500V 10MΩ (min.) (between charging and FG terminals)	

*1 Depending on the total of the expansion slot power and the external load power, the length of the allowable voltage drop will be 20 ms or less. For details, refer to the chart below.

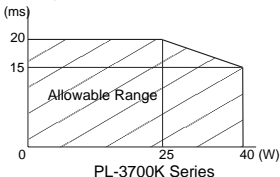
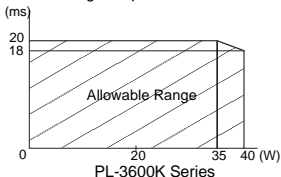

■ Environmental Specifications

Physical	Surrounding Air Temperature	0 to 50°C :without HDD 5 to 50°C :with HDD
	Storage Temperature	-20 to +60°C
	Ambient Humidity	10 to 90% RH (Not condensing, wet bulb temperature: 39°C or less. Wet bulb temperature with HDD: 29°C or less.)
	Storage Humidity	10 to 90% RH (Not condensing, wet bulb temperature:39°C or less.)
	Dust	Free of dust
	Pollution Degree	For use in Pollution Degree 2 environment

IMPORTANT

- When using any of the PL's optional devices, be sure to check that device's specifications for any special conditions or cautions that may apply to its use.
- Be aware that not only does the Hard Disk have a fixed lifetime, but that accidents can always occur. Therefore, be sure to back up your Hard Disk's data regularly, or prepare another Hard Disk unit that can be used for backup.
- The Hard Disk lifetime given here may be reduced due to unforeseen environmental factors, however, generally speaking, the disk should last for 20,000 hours (of operation) or approximately 5 years, whichever comes first at an operating temperature of 20°C and 333 hours of operation per month. (HDD access frequency of 20% or less)
- Using the Hard Disk in an environment that is excessively hot and/or humid will shorten the disk's usage lifetime. A wet bulb temperature of 29°C or less is recommended. This is equivalent to the following data.

Temperature	at 35°C	at 40°C
Humidity	no higher than 64% RH	no higher than 44% RH

- In order to extend the lifetime of the hard disk, Pro-face recommends you set the Windows® 2000's [Control panel]-[Power Management option]-[Turn off hard disks] selection or the Windows® XP's [Control panel]-[Performance and Maintenance]-[Power Management option]-[Turn off hard disks] selection to turn the hard disk off when the unit is not being operated. A setting of 5 minutes is recommended.
- Do not vibrate the hard disk continuously at the same frequency. Doing so may cause the hard disk to reduce transfer speeds or stop temporarily.

Internal Switches

To operate the internal switches, uninstall the control box and the front module.

 Installation/uninstallation of the front module and the control box (page 12)

IMPORTANT

- Make sure to turn off the power supply before using the switches. Adjusting the switches while power is supplied may cause errors.

1. Internal switches of the control box

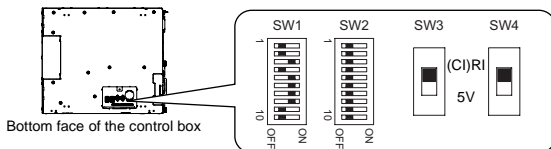

Switch Location	Switch Name	Compatible I/F	Factory Settings	Description
SW1	System Set SW	—	See ■ System Set Switch	10-point dip switch. For System Set SW and the factory settings details, see ■ System Set Switch.
SW2	Serial Mode Select SW	COM1	All OFF (RS-232C)	10-point dip switch. Designates COM1 communication settings. For Serial Mode Select SW details, see ■ Serial Mode Select Switch.
SW3	CI(RI)/+5V Changeover SW	COM2	CI(RI)	Changes # 9 pin (CI(RI) <---> +5V).
SW4	CI(RI)/+5V Changeover SW	COM1	CI(RI)	Changes # 9 pin (CI(RI) <---> +5V).

■ System Set Switch

Switch No.	Description	ON	OFF	Factory Settings	Notes
1	Internal setting	Reserved	Reserved	OFF	Do not change. (Factory setting)
2	Implements the logical inversion operation for RAS output.	Normal Close	Normal Open	OFF	RAS output is a CLOSE state when the SW and the system is ON. When the SW is OFF, it is the opposite. The RAS Output keeps Normal OPEN when the Soft OFF state occurs or the power turns OFF.
3	Sets up an enabled/disabled state for the front USB port execution control function.*1	Enabled	Disabled	ON	The front USB port is available when the SW is ON. It is unavailable when the SW is OFF.
4	Internal setting	Reserved	Reserved	OFF	Do not change. (Factory setting)
5 to 8				ON	
9 to 10				OFF	

*1 The Setting up an enabled/Disabled state for USB port execution control function is available for only Windows® 2000 and Windows® XP. Make sure to disable the function of the setting when other OS is used.

■ Serial Mode Select Switch

Switch No.	Description	ON	OFF	RS-232C	RS-422	RS-485
1	Internal setting	Reserved	Reserved	OFF ^{*1}	OFF ^{*1}	OFF ^{*1}
2	Changes COM1's communication method	RS-422/RS-485	RS-232C	OFF	ON	ON
3	Changes COM1's communication method	RS-422/RS-485	RS-232C	OFF	ON	ON
4	Changes SD (TXD) data's output mode	SD (TXD) data output is controlled via the RS (RTS) signal.	SD (TXD) data output is NOT controlled via the RS (RTS) signal. (normally output)	OFF	ON/OFF	ON/OFF ^{*2}
5	Switches the SD (TXD) termination resistance ON/OFF	Inserts termination resistance of 220Ω between SDA and SDB.	No termination	OFF	ON	ON/OFF ^{*3}
6	Switches the RD (RXD) termination resistance ON/OFF	Inserts termination resistance of 220Ω between RDA and RDB.	No termination	OFF	ON	ON/OFF ^{*3}
7	Switches the shorting of SDA and RDA ON or OFF	Shorts SDA and RDA (RS-485 mode)	No shorting (RS-422 mode)	OFF	OFF	ON
8	Switches the shorting of SDB and RDB ON or OFF	Shorts SDB and RDB (RS-485 mode)	No shorting (RS-422 mode)	OFF	OFF	ON
9	RS (RTS) Automatic control mode	The data is automatically controlled via the RS (RTS) signal.	The data is not automatically controlled via the RS (RTS) signal.	OFF	OFF	ON/OFF ^{*2}
10	(enabled only when RS-485 mode)			OFF	OFF	ON/OFF ^{*2}

*1 Be sure to keep the settings, "OFF".

*2 Set switches number 9 and 10 to ON when the SD (TXD) output driver is automatically controlled with RS (RTS). Set switch number 4 to OFF.

Set switches number 9 and 10 to OFF when the SD (TXD) output driver is controlled with the RS (RTS) signal. Set switch number 4 to ON.

*3 If you use the termination resistance, base your settings on the connection specifications.

Serial Mode Select Switches (SW4 to SW10) operate as shown in the circuit diagram below.

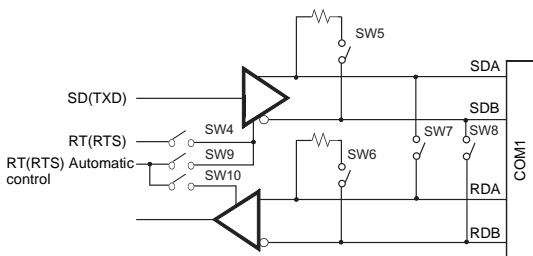

2. Internal switches of the front module

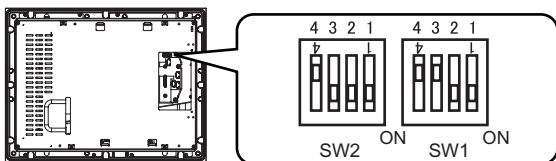

Rear face of the front module (PL-3600K Series)

Switch Location	Switch Name	Factory Settings	Description
SW1	Touch Panel Set SW	1:ON, 2:ON, 3:OFF, 4:OFF	4-point dipswitch. For Touch Panel Set SW details, see "■ Touch Panel Set SW".
SW2	—	PL-3600K Series: 1:ON, 2:ON, 3:ON, 4:OFF PL-3700K Series: 1:ON, 2:OFF, 3:ON, 4:OFF	Internal setting. Do not change. (Factory setting)

■ Touch Panel Set SW

Switch No.	Description	ON	OFF	Factory Settings	Notes
1 to 2	Internal setting	Reserved	Reserved	ON	Do not change. (Factory setting)
3				OFF	
4	Cancellation function of two point touch on the touch panel ^{*1}	Enabled	Disabled	OFF	The middle point is not considered to be touched when the SW is ON. It is considered to be touched when the SW is OFF.

*1 When two points are pushed, it is considered that middle point between the two points is touched according to the nature of the analog resistive touch panel. When the switch, etc. is set on the middle point, it will be enabled and may operate. To prevent such a switch from malfunction in case of pushing two points, turn ON the SW No.4 in advance, then the middle point will be disabled for two point touch.

External Interfaces

IMPORTANT

- This PL unit's serial port is not isolated. When the host (PLC) unit is also not isolated, and to reduce the risk of damaging the RS-232C/RS-422/RS-485 circuit, be sure to connect pin #5 SG (Signal Ground) terminal.
- Never connect NC to COM1.
- Connect FG to shell.

Serial Interface (COM1, COM2, COM3, COM4)

Interfit Bracket	#4-40 UNC
------------------	-----------

◆COM1, COM2, COM3, COM4

Pin #	RS-232C	
	Signal Name	Meaning
1	CD	Carrier Detect
2	RD(RXD)	Receive Data
3	SD(TXD)	Send Data
4	ER(DTR)	Data Terminal Ready
5	SG	Signal Ground
6	DR(DSR)	Data Set Ready
7	RS(RTS)	Request to Send
8	CS(CTS)	Clear to Send
9	CI(RI)/+5V	Called status display/ +5V Output 0.5A ^{*1} *2
Shell	FG	Frame Ground (Common with SG)

*1 Only COM1 and COM2 are available for switching to +5 V. COM3 and COM4 are used exclusively for CI (RI).

*2 Slide switch on the circuit board in the PL unit switches between CI (RI) and +5 V. For details, see [Internal Switches].

◆COM1

Pin #	RS-422 ^{*3}	
	Signal Name	Meaning
1	RDA	Receive Data A(+)
2	RDB	Receive Data B(-)
3	SDA	Send Data A(+)
4	ERA	Data Terminal Ready A(+)
5	SG	Signal Ground
6	CSB	Clear to Send B(-)
7	SDB	Send Data B(-)
8	CSA	Clear to Send A(+)
9	ERB	Data Terminal Ready B(-)
Shell	FG	Frame Ground (Common with SG)

Pin #	RS-485 ^{*3}	
	Signal Name	Meaning
1	DATA +	Send/Receive Data (+)
2	DATA -	Send/Receive Data (-)
3	NC	No Connection
4	NC	No Connection
5	SG	Signal Ground
6	NC	No Connection
7	NC	No Connection
8	NC	No Connection
9	NC	No Connection
Shell	FG	Frame Ground (Common with SG)

*3 To change the communication method, set the dip switch located on the circuit board in the PL unit to the desired position. For details, see [Internal Switches].

■ RAS Interface

IMPORTANT

- Be sure to use only the rated voltage level when using pin #1 (+12V) for external power output. Failure to do so can lead to a unit malfunction or accident.

Interfit Bracket	#4-40 UNC
------------------	-----------

Pin #	Signal Name	Meaning
1	+12V	Output Current: 100mA or less Output Voltage: 12V±5%
2	DOUT0(+)	Data out 0(+)
3	DOUT1(+)	Data out 1(+)
4	DIN0(+)	Data in 0(+)
5	DIN1(+)	Data in 1(+) ^{*1}
6	GND	Ground
7	DOUT0(-)	Data out 0(-)
8	DOUT1(-)	Data out 1(-)
9	DINCOM	Data in ground common

*1 Can be used as reset input.

NOTE

- For the circuit diagram, refer to “PL3000 Series Reference Manual”.

Installations

IMPORTANT

- Before installing the PL unit on the panel, detach the control box from the front module to configure the settings of the internal switches.

SEE → Installation/uninstallation of the front module and the control box, Internal Switches

1. Installation Requirements

- For easier maintenance, operation, and improved ventilation, be sure to install the

PL at least 50mm [1.97 in.] away from adjacent structures and other equipment. For the face to which the cable is connected, however, a space of 120 mm [4.72 in.] or more is necessary for cable curve.

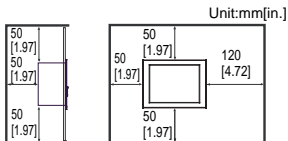

- Be sure that the surrounding air temperature and the ambient humidity are within their specified ranges. When installing the PL on the panel of a cabinet or enclosure, “Surrounding air temperature” indicates both the panel face and cabinet or enclosure’s internal temperature.

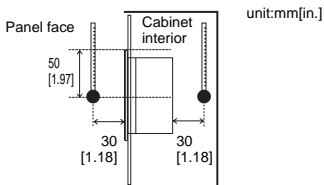

- Be sure that heat from surrounding equipment does not cause the PL to exceed its standard operating temperature.

2. PL Installation

- Create a Panel Cut following the dimensions in the following table. Also, determine the panel thickness according to the panel thickness range with due consideration of panel strength.

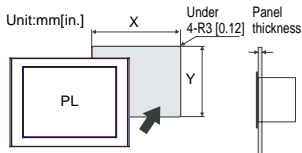

PL	X	Y	Panel thickness
PL-3600K Series	383.5^{+1}_{-0} [15.1 $^{+0.04}_{-0}$]	282.5^{+1}_{-0} [11.12 $^{+0.04}_{-0}$]	1.6[0.06] to 10.0[0.39]
PL-3700K Series	441.5^{+1}_{-0} [17.38 $^{+0.04}_{-0}$]	313.5^{+1}_{-0} [12.34 $^{+0.04}_{-0}$]	1.6[0.06] to 10.0[0.39]

NOTE

- When using the PL-3600K series to replace the 3612KPM/4612KPM from Xycom Automation, you can install the unit without adjusting the Panel Cut size. As shown in the following diagram, simply remove 7 screws from the upper and lower positions to remove attachments from the PL-3600K series unit.

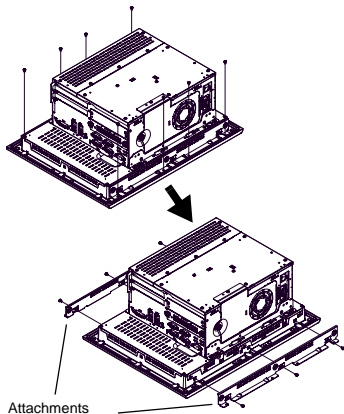

Panel Cut size without attachment

PL	X	Y	Panel thickness
PL-3600K Series (3612KPM/4612KPM compatible)	383.54 [15.10]	275.59 [10.85]	1.6[0.06] to 10.0[0.39]

- Confirm that the installation gasket is attached to the PL unit and then place the PL unit into the Panel from the front.

IMPORTANT

- It is strongly recommended that you use the installation gasket, since it absorbs vibration in addition to repelling water. For the procedure for attaching the installation gasket, refer to "PL3000 Series Hardware Manual".
- Insert each fastener's hook into the slot and tighten it with a screwdriver. Tighten the 8 screws for PL-3600K Series and 12 screws for PL-3700K Series gradually in an even, crisscross pattern.

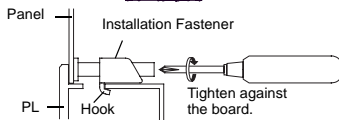
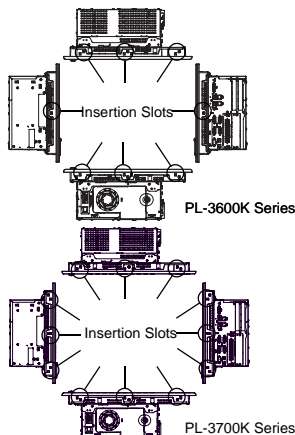

IMPORTANT

- Tightening the screws with too much force can damage the PL unit.
- The torque required to tighten these screws is 0.8 N•m.

Installation/uninstallation of the front module and the control box

⚠ WARNING

- To avoid an electric shock, prior to installation/uninstallation of the front module and the control box, confirm that the PL unit's power supply is completely turned OFF, via a breaker, or similar unit.

1. Uninstalling the front module and the control box

- (1) Unscrew the two attachment screws to detach the cover for the flexible cable.

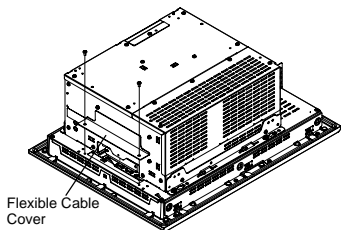

- (2) Disconnect the flexible cable.

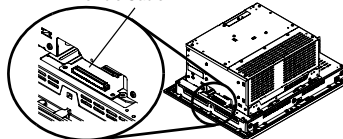

- (3) Remove four screws on the installation fasteners for the control box.

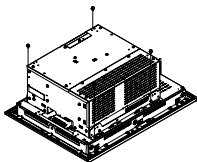

- (4) Slide the control box in direction shown by the arrow.

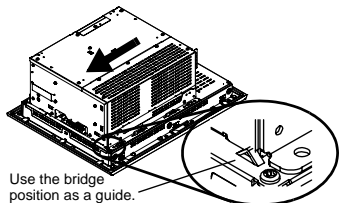

Use the bridge position as a guide.

- (5) Lift the control box and remove the front module tabs from the slot on the installation fasteners for the control box. Then remove the control box.

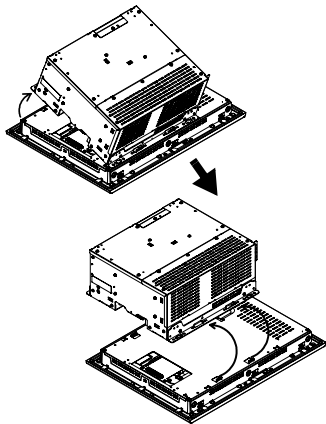

2. Installing the front module and the control box

Install the control box to the front module in the reverse order of the uninstallation steps. The necessary torque is $0.5\text{N}\cdot\text{m}$ to $0.6\text{N}\cdot\text{m}$ in every step.

Wiring

⚠ WARNING

- To avoid an electric shock, prior to connecting the PL unit's power cord terminals to the power terminal block, confirm that the PL unit's power supply is completely turned OFF, via a breaker, or similar unit.
- Any other power level can damage both the PL and the power supply.
- Since DC type has no power ON/OFF switch, be sure to attach a breaker-type switch to its power cord.
- When the FG terminal is connected, be sure the wire is grounded.

1. Wiring the AC type power supply cable

IMPORTANT

- When the FG terminal is connected, be sure the wire is grounded. Not grounding the PL unit will result in excessive noise. Use your country's applicable standard for grounding.

■ Power Cord Specifications

Use copper conductors only.

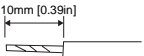
Power Cord Diameter	0.75 to 2.5mm ² (18 - 12 AWG)
Conductor Type	Simple or Stranded Wire ¹
Conductor Length	

*1 If the Conductor's end (individual) wires are not twisted correctly, the end wires may either short against each other, or against an electrode.

■ Wiring

When connecting the power code, use the following items when performing wiring.
(Items are made by Phoenix Contact.)

Recommended Driver	SZS 0.6x3.5 (1205053)
Recommended Pin Terminals	AI 0.75-10GY (3201288) AI 1-10RD (3200182) AI 1.5-10BK (3200195) AI 2.5-12BU (3200962)
Recommended Pin Terminal Crimp Tool	CRIMPFOX ZA3 (1201882)

NOTE

- Accompanying power supply connector is a CA7-ACCNL-01 of Pro-face or FKC2,5/3-STF-5,08 of Phoenix Contact.

■ Connecting the Power Cord

- (1) Confirm that the power is not supplied to the PL unit.
- (2) Push the Opening button by a small and flat screw driver to open the desired pin hole.
- (3) Insert each pin terminal into its each hole. Release the Opening button to clamp the pin place.

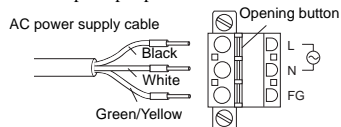

- (4) After inserting all three pins, insert the Power Plug into the Power Connector at PL. Fix the plug with two minus screws.

IMPORTANT

- Confirm that all wires are connected correctly.
- The torque required to tighten these screws is 0.5 to 0.6 N•m [5-7Lb•In].
- To prevent the possibility of a terminal short, use a pin terminal that has an insulating sleeve.

2. Wiring the DC type power supply cable

IMPORTANT

- When the FG terminal is connected, be sure the wire is grounded. Not grounding the PL unit will result in excessive noise. Use your country's applicable standard for grounding.

■ Power Cord Specifications

Use copper conductors only.

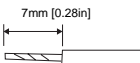
Power Cord Diameter	0.75 to 2.5mm ² (18 - 12 AWG)
Conductor Type	Simple or Stranded Wire ^{*1}
Conductor Length	

*1 If the Conductor's end (individual) wires are not twisted correctly, the end wires may either short against each other, or against an electrode.

■ Power Connector (Plug) Specifications

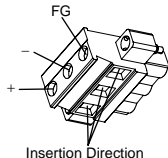
	+	24V
	-	0V
	FG	Grounding Terminal connected to the PL chassis

NOTE

- Accompanying power supply connector is CA5-DCCNL-01 of Pro-face or GMVSTBW2.5-3-STF-7.62 of Phoenix Contact.

When connecting the power cord, use the following items when performing wiring. (Items are made by Phoenix Contact.)

Recommended Driver	SZF 1-0.6x3.5 (1204517)
Recommended Pin Terminals	AI 0.75-8GY (3200519) AI 1-8RD (3200030) AI 1.5-8BK (3200043) AI 2.5-8BU (3200522)
Recommended Pin Terminal Crimp Tool	CRIMPFOX ZA 3 (1201882)

■ Connecting the PL Power Cord

- (1) Confirm that the power is not supplied to the PL unit.
- (2) Loosen three screws in the center of the Power Connector (plug).

- (3) Strip the power cord, twist the conductor's wire ends, insert them into the pin terminal and crimp the terminal. Attach the terminal to the Power Connector.

IMPORTANT

- Use a flat-blade screwdriver (Size 0.6 x 3.5) to tighten the terminal screws. The torque required to tighten these screws is 0.5 to 0.6 N•m [5-7Lb•In.].
- Do not solder the cable connection.

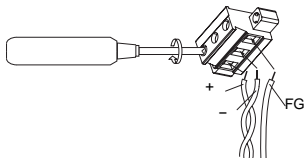

- (4) Attach the Power Connector (plug) to the PL and fix it to the PL main unit with right/left tightening screws.

3. Power Supply Cautions

- Input and Output signal lines must be separated from the power control cables for operational circuits.
- To improve the noise resistance, be sure to twist the ends of the power cord wires before connecting them to the Power connector (Plug).
- The PL unit's power supply cord should not be bundled with or kept close to main circuit lines (high voltage, high current), or input/output signal lines.
- To reduce noise, make the power cord as short as possible.
- If the supplied voltage exceeds the PL unit's range, connect a voltage transformer.
- Between the line and the ground, be sure to use a low noise power supply. If there is an excess amount of noise, connect a noise reducing transformer.
- The temperature rating of field installed conductors: 75°C only.

IMPORTANT

- Use voltage and noise reducing transformers with capacities exceeding Power Consumption value.
- Branch Circuit Protective device shall be use for rating 20A for DC24V input device.
- Connect a surge absorber to handle power surges.
- Be sure to ground the surge absorber (E1) separately from the PL unit (E2). Select a surge absorber that has a maximum circuit voltage greater than that of the peak voltage of the power supply.

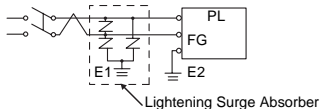

4. Grounding Cautions

- Be sure to create an exclusive ground for the Power Cord's FG terminal. Use a grounding resistance of 100Ω , a wire of 2mm^2 or thicker, or your country's applicable standard.
- The SG (signal ground) and FG (frame ground) terminals are connected internally in the PL unit. When connecting the SG line to another device, be sure that the design of the system/connection does not produce a shorting loop.
- The grounding wire should have a cross sectional area greater than 2mm^2 . Create the connection point as close to the PL unit as possible, and make the wire as short as possible. When using a long grounding wire, replace the thin wire with a thicker wire, and place it in a duct.

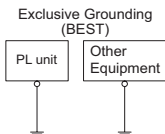

Common Grounding (OK)

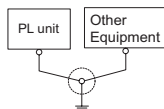

Common Grounding (Not OK)

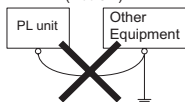

5. Input/Output Signal Line Cautions

- All PL Input and Output signal lines must be separated from all operating circuit (power) cables.
- If this is not possible, use a shielded cable and ground the shield.
- To improve noise immunity, it is recommended to attach a ferrite core to the power cord.

To prevent the USB cable from coming off

■ Attaching the USB Cable Clamp

- (1) Place the PL unit face-down on a flat surface as shown below. Your PL unit has four USB connectors.

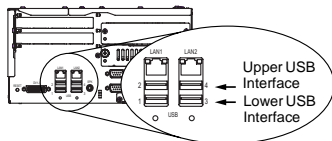

NOTE

- When using two or more USB ports, be sure to first connect one USB cable to the lower USB connector, and then connect the second USB cable to the upper USB connector.
 - When using only one of the USB ports, be sure to use the lower USB connector. This allows you to securely clamp the USB cable in the cable clamp.
 - The USB cable clamp is not compatible with the USB connector on the front face.
- (2) Fix the USB holder with two screws.
The torque required to tighten these screws is 0.5 to 0.6 N•m.

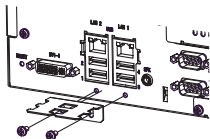

- (3) As the figure shows, pass the USB Cable Clamp's band around the depressed surface of the holder, twist the USB Cable Clamp's band around the USB cable, pull the band in the direction of the arrow, and then fasten the band using the clamp.

NOTE

- Be sure the clamp is securely holding the USB cable's plug and collar.
- Be sure the clamp is positioned as shown below, with the clamp pointing upwards - not to the side. This is to keep the clamp from interfering with nearby connectors and their cables.

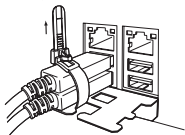
**■ Removing the USB Cable Clamp**

- (1) To remove the clamp from the USB cables, push down on the clamp strap's clip to release it while pulling up on the clamp.

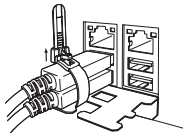
**UL/c-UL Approval**

The following units are UL/c-UL listed products:
(UL File No.E220851)

Product Model No.	UL/c-UL Registration Model No.
APL3600-KA	3582302-01 Front module: 3620003-04
APL3700-KA	3582302-01 Front module: 3620003-05
APL3600-KD	3582302-11 Front module: 3620003-04
APL3700-KD	3582302-11 Front module: 3620003-05

These products conform to the following standards:

■ UL508

Industrial Control Equipment

**■ CSA-C22.2 No.142-M1987
(c-UL Approval)**

Process Control Equipment

<Cautions>

Be aware of the following items when building the PL into an end-use product:

- The PL unit's rear face is not approved as an enclosure. When building the PL unit into an end-use product, be sure to use an enclosure that satisfies standards as the end-use product's overall enclosure.
- The PL unit must be used indoors only.
- Install and operate the PL with its front panel facing outwards.

- If the PL is mounted so as to cool itself naturally, be sure to install it in a vertical panel. Also, according to the installation requirements, create space around the rear face of the PL unit. The temperature must be checked on the final product in which the PL unit is installed.
- For use on a flat surface of a Type 1 Enclosure.

CE Marking

- APL3600-KA/APL3700-KA units are CE marked product that conforms to EMC directives and Low Voltage Directives EN55011 Class A, EN61000-6-2, and EN60950-1.
- APL3600-KD/APL3700-KD units are CE marked product that conforms to EMC directives EN55011 Class A and EN61000-6-2.

Inquiry
Do you have any questions about difficulties with this product? Please access our site anytime that you need help with a solution. http://www.pro-face.com/otasuke/

Note

Please be aware that Digital Electronics Corporation shall not be held liable by the user for any damages, losses, or third party claims arising from the uses of this product.

Digital Electronics Corporation
8-2-52 Nanko-higashi
Suminoe-ku, Osaka 559-0031
JAPAN
TEL: +81-(0)6-6613-3116
FAX: +81-(0)6-6613-5888
<http://www.pro-face.com/>

© Copyright 2008 Digital Electronics Corporation. All rights reserved.

