

# **Memory Loader II**

# **Operation Manual**

Digital Electronics Corporation



# Preface

Thank you for purchasing Digital's Memory Loader II. This equipment has been manufactured with the goals of facilitating maintenance work on our GP Series units, and achieving high speed data copying from one GP panel to another. Before using the Memory Loader II, please be sure to read this manual carefully to ensure that you use the product properly and get optimum use of its functions.

In this manual, the "GP Series" refers to the following GP graphic display panels:

GP-230 Series	GP-230G, GP-230S, GP-230B, GP-230H
GP-*3J Series	GP-43J, GP-53JT, GP-53JS
GP-*50 Series	GP-250B, GP-250L, GP-250S, GP-450E, GP-550T, GP-550S, GP-B50
GP70 Series	GP-H70L, GP-H70S, GP-270L, GP-270S, GP-370L, GP-370S, GP-470E, GP-570L, GP-570S, GP-570T, GP-570VM, GP-571T, GP-57JS, GP-675S, GP-675T, GP-870VM, GP-377L, GP-377S
GP77R Series	GP-377RT, GP-477RE, GP-577RT, GP-577RS
GLC Series	GLC100L, GLC100S, GLC300T
CGP Series	CGP-370L, CGP-370S
Easy Series	Easy20L, Easy20S, Easy40, Easy50S, Easy50T

1. It is forbidden to copy the contents of this manual, either in whole or in part, except for the purpose of user's personal use, without the express written permission of the Digital Electronics Corporation of Japan.
2. The information provided in this manual is subject to change without notice.
3. This manual has been written with care, however, should the user discover any errors or omissions, please contact the Digital Electronics Corporation and inform them of your findings.
4. Please be aware that the Digital Electronics Corporation is not responsible for any damages resulting from the use of its products, regardless of article 3 above.

All company or manufacturer names used in this manual are the registered trademarks of their respective companies.

© Copyright 1998, Digital Electronics Corporation

MS-DOS® and Windows®95 are registered trademarks of the Microsoft Corporation.

IBM® DOS® are registered trademarks of IBM.



## General Safety Precautions

- Due to the possibility of electric shock, be sure to turn OFF the GP panel's power prior to connecting the Memory Loader II.
- Do not use power which is outside of the specified voltage range.
- Do not use the Memory Loader II in an environment that contains flammable gases, since it may cause explosion.
- Due to the possibility of electric shock, be sure to turn OFF the Memory Loader II's power prior to replacing the batteries.

### To Avoid Damaging the Memory Loader II

- DO NOT press the Memory Loader II's LCD display surface with excessive force or with a hard object. Otherwise, the LCD display surface may be damaged.
- Storing or operating the Memory Loader II in environments with temperatures outside the specified allowable ranges may cause the unit to break down.
- Do not allow water, liquids, or metal particles to enter into the Memory Loader II's case, since it can cause a malfunction or electrical shock.
- Avoid operating the Memory Loader II in locations where sudden temperature changes can cause condensation to form inside the unit, since this can cause the unit to malfunction.
- DO NOT store or use the unit in a high-temperature environment.
- Avoid storing or operating the Memory Loader II in either direct sunlight or in excessively dusty or dirty environments.
- Because the Memory Loader II is a precision instrument, do not use or store it in locations where excessive jolting or vibration can occur.
- Do not use paint thinner or organic solvents to clean the Memory Loader II's case or display.
- If dead batteries are left in the unit for a long period of time, the batteries may leak, causing damage to the unit. When the unit is not used for long periods of time, remove the batteries from the unit.
- Place the batteries in the correct orientation. If they are placed incorrectly, heat may be generated.
- Do not store or operate the Memory Loader II where chemicals and acids are stored or where high concentrations of fumes are present. The Memory Loader II may either malfunction or be damaged as a result.

# Table of Contents

## Preface

Preface .....	1
General Safety Precautions .....	2
Table of Contents .....	3
Packing Box Contents .....	5
Information Symbols .....	6

## Chapter 1 Introduction

1-1 Memory Loader II Features .....	1-1
1-2 System Design .....	1-2

## Chapter 2 Specifications

2-1 General Specifications .....	2-1
2-1-1 Electrical Specifications .....	2-1
2-1-2 Environmental Specifications .....	2-1
2-2 Performance Specifications .....	2-2
2-2-1 External Interface .....	2-2
2-2-2 Special Features .....	2-2
2-3 Component Names .....	2-3
2-4 External Dimensions and Views .....	2-4

## Chapter 3 Operation

3-1 Memory Loader II Features .....	3-1
3-1-1 Block Transfer .....	3-1
3-1-2 Screen Transfer .....	3-2
3-2 Communication Modes .....	3-3
3-3 From Start Up to Quitting .....	3-4
3-4 GP Transfer .....	3-5
3-4-1 Starting Up GP Transfer Mode .....	3-5
3-4-2 Uploading Data .....	3-6
3-4-3 Downloading Data (Block Transfer) .....	3-8
3-4-4 Downloading Data (Screen Transfer) .....	3-13
3-4-5 Clearing Memory Card Data .....	3-15
3-4-6 Completing GP Transfer .....	3-17

3-5	Personal Computer Transfer .....	3-18
3-5-1	Start Up Personal Computer Transfer Mode .....	3-19
3-5-2	GP-PRO/PB III for Windows95 Screen Transfer .....	3-20
3-5-3	Receiving Data (Screen Transfer) .....	3-21
3-5-4	Clearing Memory Card Data .....	3-24
3-5-5	Completing Personal Computer Transfer .....	3-25
3-6	Maintenance .....	3-27
3-6-1	Starting Up Maintenance Mode .....	3-27
3-6-2	Data Confirmation .....	3-28
3-6-3	Self-diagnosis .....	3-29
3-6-4	Quitting Maintenance Mode .....	3-33

## Chapter 4 Error Messages

4-1	Error Messages .....	4-1
4-1-1	Memory Loader II Error Messages .....	4-1

## Packing Box Contents

---

The Memory Loader II's packing box contains the items listed below. Please confirm that everything illustrated here has been included.

■ **Memory Loader II [1 unit]**

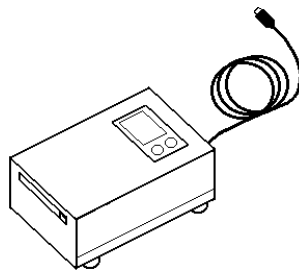

■ **Memory Loader II  
Operation Manual [1]**

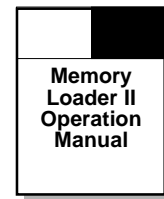

■ **Memory card [1]**  
(Made by Fujitsu, MB98A81273  
4MB)

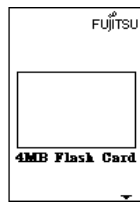

■ **AC adapter [1]**  
(100 volts)

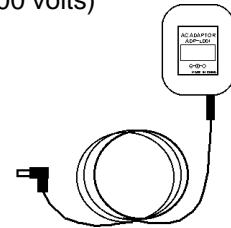





■ **Size AA alkaline batteries  
[2]**



This unit has been carefully packed, however, should you find any item to be either damaged or missing, please contact your local Memory Loader II distributor immediately for service.

## Information Symbols

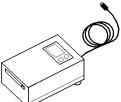
The list below describes the symbols and abbreviations used in this manual.

<b>GP</b>	Represents Digital's GP Series and the Easy Series of graphic panels, which are compatible with the Memory Loader II (introduced in Preface).
<b>PC</b>	Designates a standard, IBM compatible "personal computer."
 <i>Important</i>	Instructions or procedures that must be performed to ensure correct product use. Please be sure to read them carefully.
 <i>Note:</i>	Indicates helpful information for you to keep in mind, or usage hints.
 <b>Reference</b>	Reference pages of related sections and topics.
*1	Indicates supplemental explanatory information is located nearby, usually at the bottom of the page.
1. 2.	Represents operating procedures. Follow the numbers in order to perform the operations.
	Indicates that the following procedures/displays should be performed/will appear on the Memory Loader II.
	Indicates that the procedures/displays should be performed/will appear on your personal computer. *1

\*1 *Personal computer-related features are currently available only with GP-PRO/PBIII ML versions 2.0 or higher.*



## Introduction

### 1-1 Memory Loader II Features

The Memory Loader II has the following features:

#### ◆ Compact and Easy To Use

The Memory Loader II unit can be connected to the GP's tool connector interface and data can be copied from one GP panel to another via the memory card inserted in the unit. The Memory Loader II is a compact box-type unit, making it easy to use on the job site.

#### ◆ High Speed Data Transfer

HS-LINK protocol\*<sup>1</sup> is used to transfer data, and by compressing the transfer data, it can be transferred rapidly.

---

\*1 The HS-LINK protocol is a specially made, data compression protocol.

# 1-2 System Design

Available Memory Loader II peripheral equipment is as shown below:

### GP Series Units

**Reference** For compatible GP models, refer to "Preface."

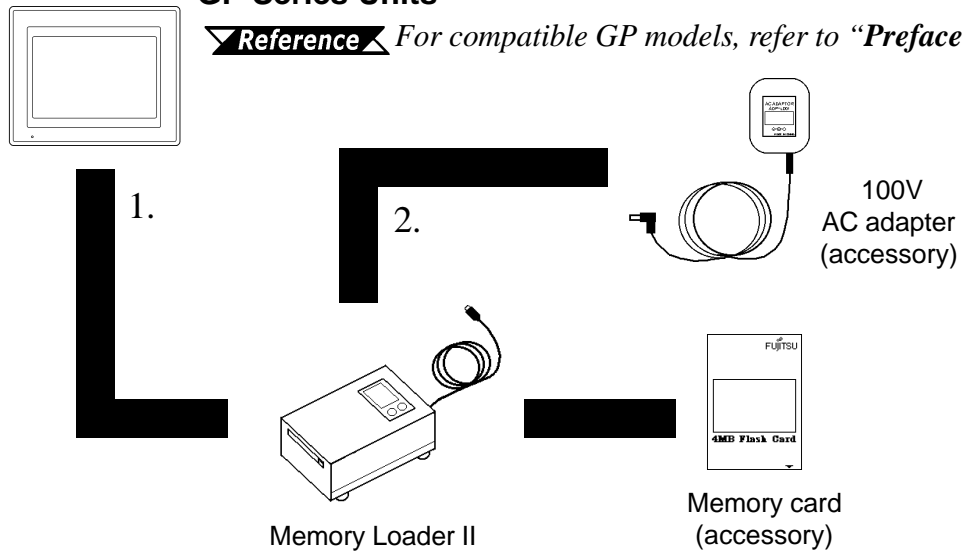

3.



RS-232C cross cable (Recommended\*1)

4.

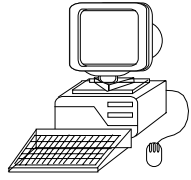

Personal computer\*2

### Cross cable pin assignment

Dsub 9-pin female	Dsub 25-pin male
1 CD	4 RS
	5 CS
2 RXD	2 SD
3 TXD	3 RD
4 DTR	6 NC
5 GND	7 GND
6 DSR	20 ER
7 RTS	8 CD
8 CTS	1 NC
SHELL	SHELL

### GP Interface

- 1. Tool connector

### Memory Loader II Interfaces

- 2. External DC input
- 3. Personal Computer Interface

### Personal Computer Interface

- 4. Serial interface

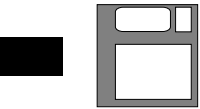

GP Screen Creation/Editing Software  
 GP-PRO/PB III for Windows95  
 (version 2.0 or higher)  
 GPW-PB01 \* (CD)  
 GPW-PB02 \* (FD)

\*1 Reverse cable C232R-PD15 (1.5m) made by Elecom

\*2 Compatible personal computer models may be limited.

**Reference** GP-PRO/PB III for Windows95 Operation Manual.

# 2

## Specifications

2-1 General Specifications

2-2 Performance Specifications

2-3 Component Names

2-4 External Dimensions and Views

### 2-1 General Specifications

#### 1 Electrical Specifications

<b>Power Supply</b>	Batteries: Size AA alkaline batteries [2] AC adapter (100V): EIAJ RC-5320A, voltage class 3 (for 9V DC output)
<b>Power Consumption</b>	Batteries: 400mA or less (3V) AC adapter (100V): 200mA or less (9V DC) (Assumed average power consumption level during data transfer.)
<b>Battery Operation Life</b>	Approximately 1 hour, when used continuously



- **Prior to changing the power supply source from batteries to the AC adapter, be sure to turn OFF the Memory Loader II's power. DO NOT change from batteries to the AC adapter while operating the Memory Loader II. Otherwise, all the Memory Loader II's settings will be reset.**
- **The batteries are to be used as an emergency backup. For regular use, use the AC adapter.**
- **When using batteries, be sure to use the alkaline type.**
- **The AC adapter is only 100V not 200V.**

#### 2 Environmental Specifications

<b>Operating Temperature</b>	0 to 50°C
<b>Storage Temperature</b>	-10 to 60°C
<b>Ambient Humidity</b>	30 to 85% RH (no condensation)
<b>Atmosphere</b>	Free of corrosive gas

## 2-2 Performance Specifications

### 1 External Interface

<p><b>Personal computer interface</b> (D-sub25S)</p> <table border="1"> <tr><td>2 SD</td></tr> <tr><td>3 RD</td></tr> <tr><td>4 RS</td></tr> <tr><td>5 CS</td></tr> <tr><td>7 GND</td></tr> <tr><td>8 CD</td></tr> <tr><td>20 ER</td></tr> </table>	2 SD	3 RD	4 RS	5 CS	7 GND	8 CD	20 ER	<p>Asynchronous type: RS-232C Data length: 8 bits Stop bit: 1 bit Parity check: None Transfer speed: 38400bps, automatic switching</p>	
2 SD									
3 RD									
4 RS									
5 CS									
7 GND									
8 CD									
20 ER									
<p><b>GP interface</b> (Mini D-Sub Connector Din 8-pin)</p> <table border="1"> <tr><td>1 RD</td></tr> <tr><td>2 GND</td></tr> <tr><td>3 CS</td></tr> <tr><td>4 SD</td></tr> <tr><td>5 CD</td></tr> <tr><td>6 RS</td></tr> <tr><td>7 ER</td></tr> <tr><td>8 Vcc</td></tr> </table>	1 RD	2 GND	3 CS	4 SD	5 CD	6 RS	7 ER	8 Vcc	<p>Asynchronous type: TTL level Data length: 8 bits Stop bit: 2 bits Parity check: None Transfer speed: 9600bps</p>
1 RD									
2 GND									
3 CS									
4 SD									
5 CD									
6 RS									
7 ER									
8 Vcc									
<p><b>Memory card interface</b> (JEIDA standard)</p>	<p>Compatible memory card MB98A81273, made by Fujitsu (4M from 5V-single wire)</p>								
<p><b>External DC Input</b></p>	<p>AC adapter EIAJ RC-5320A, voltage class 3 (for 9V output)</p>								

### 2 Special Features

■ **Power Supply Monitoring**

If the battery power supply level falls below the set voltage value (approx. 2.2V), “Batt Err” will appear on the Memory Loader II’s LCD display and operation will stop.

■ **Sleep Mode**

While the batteries are supplying power, if no operation is performed for the set period of time (1 min.) in the stand-by mode, the Memory Loader II’s LCD display message will disappear in order to reduce battery consumption. When the [Mode] switch or [Start] switch is pressed, the display will reappear.

## 2-3 Component Names

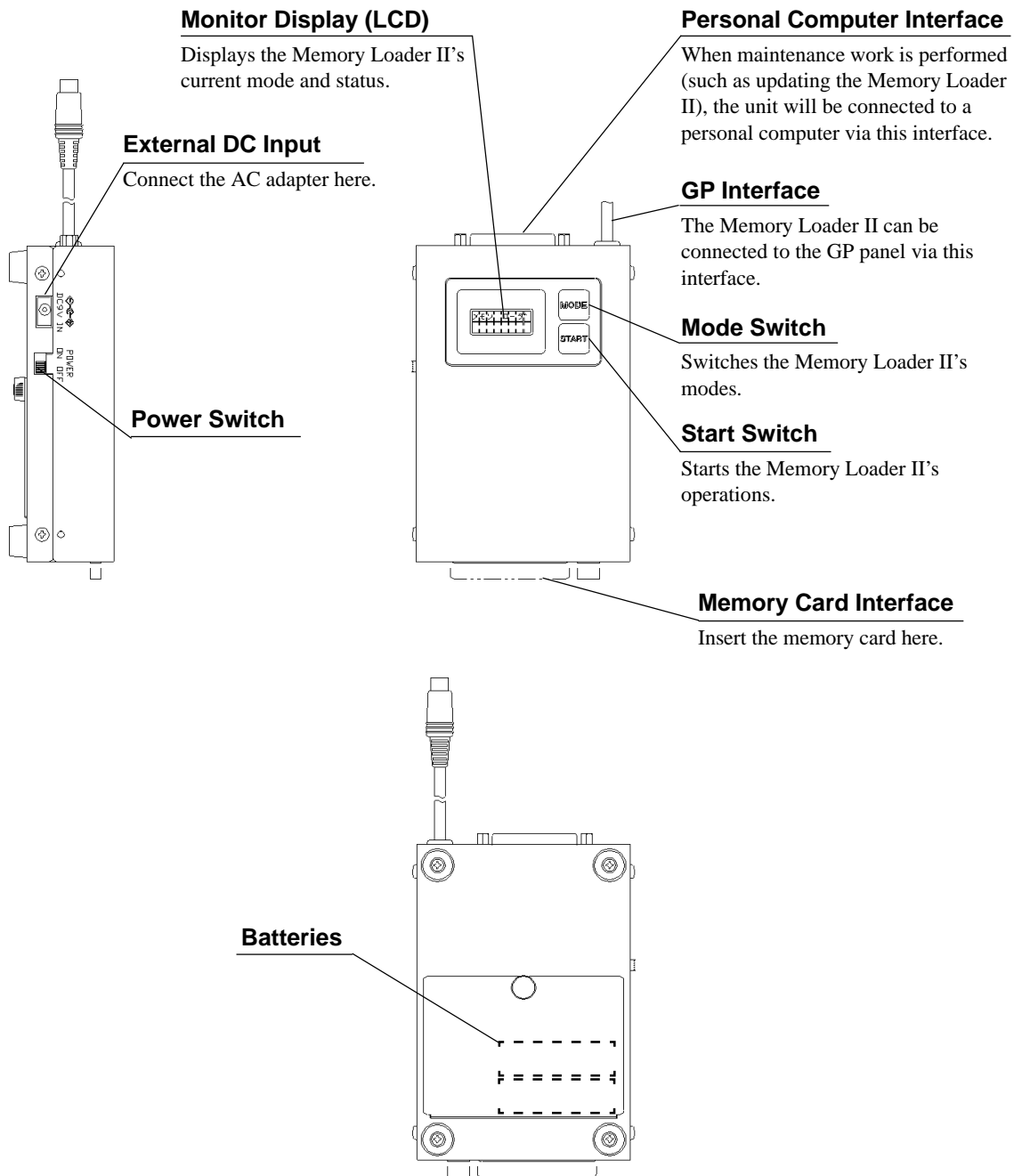

## 2-4 External Dimensions and Views

Unit: mm

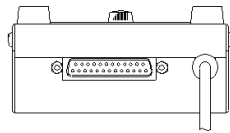

top

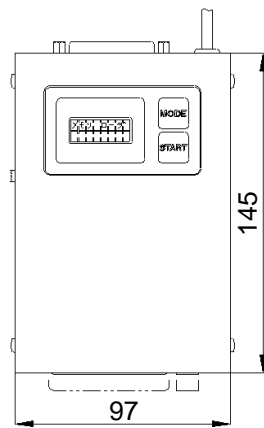

front

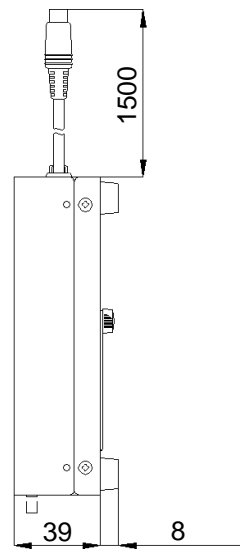

side

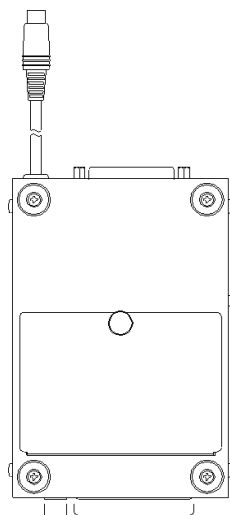

rear

# Chapter 3

## Operation

- 3-1 Memory Loader II Features
- 3-2 Communication Modes
- 3-3 From Start Up to Quitting
- 3-4 GP Transfer
- 3-5 Personal Computer Transfer
- 3-6 Maintenance

### 3-1 Memory Loader II Features

The Memory Loader II has the following features:

- Block Transfer:** Data (system, communication protocol, screen data) transferred to a GP panel is read (uploaded) and stored on the memory card. This stored data can be transferred (downloaded) to other GP panels.
- Screen Transfer\*<sup>1</sup>:** Only screen data created using the GP Screen Editing software will be stored in the Memory Loader II. This stored data will be transferred (downloaded) to a GP panel.
- Maintenance:** Memory Loader II's self-diagnosis function

Data transfer between the Memory Loader II and a GP panel is called "GP Transfer", and data transfer between the Memory Loader II and a personal computer is called "Personal Computer Transfer."

#### 1 Block Transfer

##### ■ Block Transfer Process

Copying data from one GP panel to another

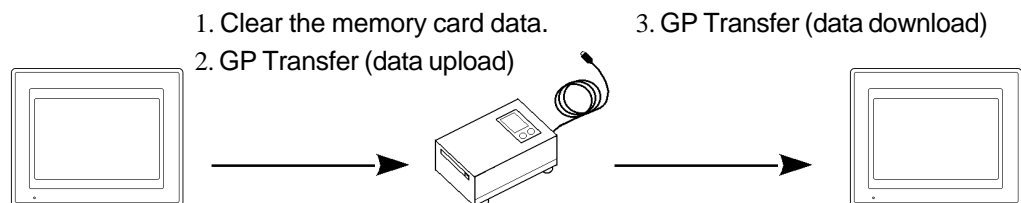

\*1 The Screen Transfer function is only compatible with the GP70 Series and the CGP Series.

## 2 Screen Transfer\*1

### ■ Screen Data Transfer Process

Sending screen data from a personal computer to a GP panel

- |  |   |                                   |
|--|---|-----------------------------------|
| 1. Screen data creation                | 3. Clear the memory card data.                    | 5. GP Transfer<br>(data download) |
| 2. Screen data transfer<br>preparation | 4. Personal Computer Transfer*2<br>(data receive) |                                   |

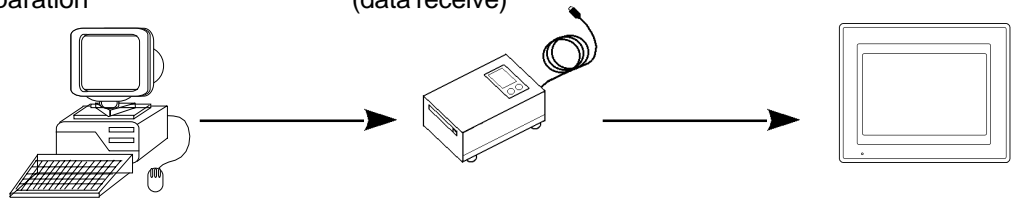

\*1 When using this feature, the project's system and protocol data must also be transferred.

\*2 This feature is available only with GP-PRO/PB III for Windows ML Ver. 2.0 or higher.



### 3-2 Communication Modes

The Memory Loader II has the three communication modes: GP Transfer, Personal Computer Transfer<sup>\*1</sup>, and Maintenance.

#### ■ GP Transfer

In this mode, data is transferred between the Memory Loader II and a GP panel. GP Transfer has the following 4 modes:

**Upload:** Reads out GP internal data, and writes it into the memory card.  
(GP -> Memory Loader II)

**Download:** Writes uploaded data, which has been written into the memory card (Block Transfer), and screen data, which has been created using GP-PRO/PB III for Windows95 (Screen Transfer), into a GP panel.  
(Memory Loader II -> GP)

**Clear:** Initializes the memory card.

**End:** Ends the GP Transfer mode.

#### ■ Personal Computer Transfer

In this mode, data is transferred between the Memory Loader II and a personal computer. Personal Computer Transfer has the following 4 modes:

**Receive:** Writes screen data, which has been created using GP-PRO/PB III for Windows95 (Screen Transfer), into the memory card. (Personal Computer -> Memory Loader II)

**Clear:** Initializes the memory card.

**End:** Ends the Personal Computer Transfer mode.

#### ■ Maintenance

This mode allows you to diagnose the memory card and Memory Loader II. Maintenance has the following 3 modes:

**Data confirmation:** Displays data stored in the memory card concerning the GP type, system version, data size, core ID and PLC type.

**Self-diagnosis:** Tests a variety of Memory Loader II items.

**End:** Ends the Maintenance mode.

---

<sup>\*1</sup> This feature is available only with GP-PRO/PB III for Windows95 ML Ver. 2.0 or higher.

## 3-3 From Start Up to Quitting

### ■ Basic Operating Procedure

The following flow charts show the Memory Loader II's basic operation from Startup to Quit, in the GP Transfer communication mode.

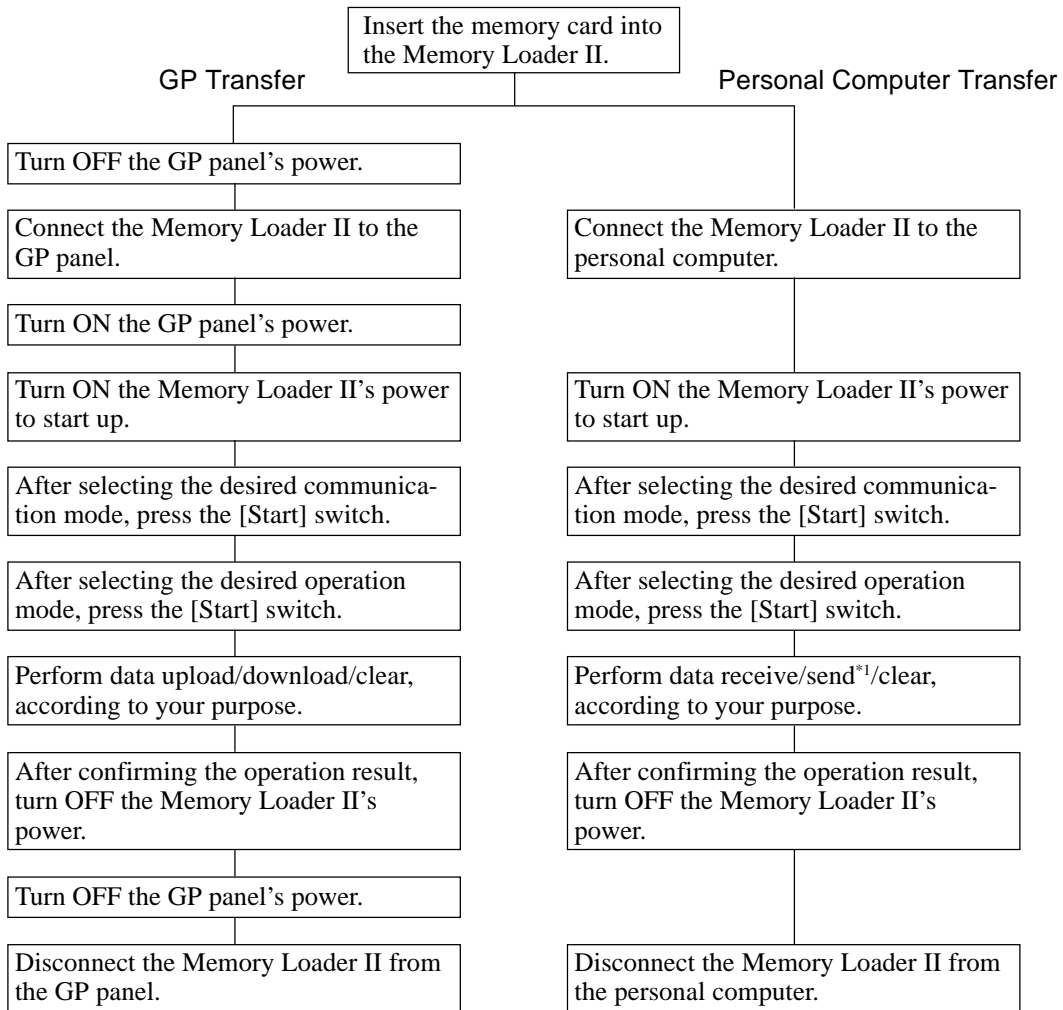

- **Prior to connecting the Memory Loader II to a GP panel, be sure to turn OFF the GP Panel's power. Also, prior to starting up or turning OFF the Memory Loader II, be sure to turn ON the GP panel's power.**
- **When disconnecting the cable, be sure to hold the plug itself and NEVER pull the cable itself. Otherwise, the cable may be damaged, causing the Memory Loader II not to work.**
- **DO NOT disconnect the cable while processing data. Otherwise, the Memory Loader II will stop operating, terminating the writing of data.**

\*1 Send Data is possible only with the Japanese unit.



## 3-4 GP Transfer

In this mode, data (system, communication protocol, screen data) uploading or downloading is performed between the Memory Loader II and a GP panel.

### 1 Starting Up GP Transfer Mode

Here, the procedures for starting up the Memory Loader II and to setting the communication mode to GP Transfer are described.

#### ■ GP Data Transfer Startup Procedures

PROCEDURE	REMARKS
<ol style="list-style-type: none"> <li>1. Turn OFF the GP panel's power.</li> <li>2. Connect the Memory Loader II to the GP panel.</li> <li>3. Turn ON the GP panel's power.</li> <li>                      4. Turn ON the Memory Loader II's power.                 </li> </ol> <p>The startup message and the Memory Loader II's version will appear. Then the Memory Loader II will start up.</p> <div style="display: flex; align-items: center; margin-bottom: 10px;"> <div style="border: 1px solid black; padding: 5px; margin-right: 10px;">Memory Loader</div> <div style="margin-left: 10px;">← Startup message (approx. 1 second)</div> </div> <div style="text-align: center; margin-bottom: 10px;">↓</div> <div style="display: flex; align-items: center;"> <div style="border: 1px solid black; padding: 5px; margin-right: 10px;">Ver *.*</div> <div style="margin-left: 10px;">← Version (approx. 1 second)</div> </div>	<div style="display: flex; align-items: center;">  <p><b>Note:</b> The batteries are only for emergency use. Use the AC adapter that came with the Memory Loader II.</p> </div>

PROCEDURE	REMARKS
<p>5. Use the [Mode] switch to set the communication mode to GP Transfer [Ld = Gp], and press the [Start] switch to register it.</p> <p>Every time the [Mode] switch is pressed, the communication mode will change.</p> <div style="display: flex; align-items: center; margin-bottom: 10px;"> <div style="border: 1px solid black; padding: 2px; margin-right: 10px;">Mode? Ld=Gp</div> <div>← Communication mode</div> </div> <div style="display: flex; align-items: center; margin-bottom: 10px;"> <div style="margin-right: 10px;">↓</div> <div>← Press the [Start] switch.</div> </div> <div style="display: flex; align-items: center; margin-bottom: 10px;"> <div style="border: 1px solid black; padding: 2px; margin-right: 10px;">Ld=Gp? Setting.</div> <div>← GP Transfer preparation (approx. 20 seconds)</div> </div> <div style="display: flex; align-items: center; margin-bottom: 10px;"> <div style="margin-right: 10px;">↓</div> <div>← Operation mode selection screen</div> </div> <div style="display: flex; align-items: center; margin-bottom: 10px;"> <div style="border: 1px solid black; padding: 2px; margin-right: 10px;">Ld=Gp? GP-&gt;Ld</div> <div>← Operation mode selection screen</div> </div>	<p><b>Note:</b> The communication mode will change in the following order:</p> <div style="border: 1px solid black; padding: 10px; margin: 10px 0;"> <pre> graph TD     A[GP Transfer (Ld = Gp)] --&gt; B[Personal Computer Transfer *1 (Ld = Pc)]     B --&gt; C[Maintenance (Maintain)]             </pre> </div> <p><b>Note:</b> During GP Transfer preparation, the GP panel's display will disappear. After the GP Transfer preparations have been completed, the following display will appear on the GP panel: "Memory Loader."</p>

## 2 Uploading Data

This feature uploads GP data (system, communication protocol, screen data) to the Memory Loader II.



**Prior to uploading data, be sure to clear the memory card's internal data. If data is uploaded when the memory card still contains internal data, an error will occur and the operation will be terminated.**

**Reference** Refer to 3-4-5, "Clearing Memory Card Data."

\*1 This feature is available only with GP-PRO/PB III for Windows95 ML Ver. 2.0 or higher.

# Operation

## ■ Data Upload Procedures

PROCEDURE	REMARKS
<p> 1. Set the communication mode to GP Transfer.</p> <p>2. Use the [Mode] switch to select the operation mode's Upload function [Gp -&gt; Ld], and press the [Start] switch to register it.</p> <p>Every time the [Mode] switch is pressed, the operation mode will change.</p> <div data-bbox="304 741 708 819" style="border: 1px solid black; padding: 5px; display: inline-block;">             Ld=Gp? Gp-&gt;Ld           </div> ← Operation mode <p>3. Confirm desire to start uploading data.</p> <div data-bbox="304 920 454 999" style="border: 1px solid black; padding: 5px; display: inline-block;">             Gp-&gt;Ld Start?           </div> <p>4. Press the [Start] switch to start uploading data.</p> <p>The data size will be displayed on the GP.</p> <div data-bbox="300 1160 933 1809"> <p>Operation mode      Operation status</p> <div style="border: 1px solid black; padding: 5px; display: inline-block; margin-bottom: 10px;">             GP-&gt;Ld ** ****kB           </div> <p>↑ Processed data size (in Kilobytes)</p> <div style="border: 1px solid black; padding: 5px; display: inline-block; margin-bottom: 5px;">             Gp-&gt;Ld RX ****kB           </div> <div style="border: 1px solid black; padding: 5px; display: inline-block; margin-bottom: 5px;">             Gp-&gt;Ld WT ****kB           </div> <p>↓</p> <div style="border: 1px solid black; padding: 5px; display: inline-block;">             Gp-&gt;Ld OK ****kB           </div> <p style="margin-left: 20px;">Data reading and writing will be repeated several times.</p> <p style="margin-left: 20px;">Data upload is completed.</p> </div>	<p><b>Reference</b> Refer to 3-4-1, "Starting Up GP Transfer Mode."</p> <p><b>Note:</b> The operation mode will change in the following order:</p> <div data-bbox="1013 728 1420 907" style="border: 1px solid black; padding: 10px; margin: 10px 0;"> <p style="text-align: center;">Download (Ld -&gt; Gp)      Upload (Gp -&gt; Ld)</p> <p style="text-align: center;">End (End)      Clear (Clear)</p> </div> <p><b>Note:</b> In order to cancel the data upload operation, press the [Mode] switch, and the GP panel display will return to the operation mode selection screen.</p> <p><b>Note:</b> When data upload starts, the following display will appear on the GP:</p> <div style="margin-left: 40px;"> <p>Memory Loader Transfer *****KB Gp-&gt;Ld</p> <p style="text-align: center;">↓</p> <p>Memory Loader  *****KB Gp-&gt;Ld</p> </div> <p>5. Press the [Start] switch to end data upload.</p>

PROCEDURE	REMARKS
<p>The Memory Loader II's LCD display will return to the operation mode selection screen.</p> <ul style="list-style-type: none"> <li>• Standard data processing time periods:</li> </ul> <div style="border: 1px solid black; padding: 5px; display: inline-block;">                     Ld=Gp? Ld-&gt;Gp                 </div> <p style="margin-left: 20px;">← Operation mode</p>	<p> <b>Note:</b></p> <p>GP70 Series            approx. 11 minutes</p> <p>GP-270 Series:        approx. 7.5 minutes</p> <p>GP-571, GP675:        approx. 22 to 27 minutes</p> <p>GP-377, GP-377R:    approx. 19 minutes</p> <p>GP-477R, GP-577R:    approx. 29 minutes</p> <p>GLC Series:            approx. 21 minutes</p> <p>GP-230 Series:        approx. 3 minutes</p> <p>GP-*3J Series:        approx. 4 minutes</p> <p>GP-250 Series:        approx. 6 minutes</p> <p>GP-*50 Series:        approx. 9 to 15 minutes</p> <p>CGP Series:            approx. 11 minutes</p> <p>Easy20 Series:        approx. 3 minutes</p> <p>Easy40/50 Series:    approx. 4 minutes</p>

### 3 Downloading Data (Block Transfer)

Here, data which has been uploaded from a GP panel will be written to another GP panel.

When data is written, the GP panels' model codes, data size and system versions will be checked. If these items do not match, an error will occur and data downloading will stop.

Even though downloading stops for this reason, you can transfer the data forcefully if necessary will stop.

**Reference** Refer to "Forced Transfer Procedure" in this section and 4-1-1 "Memory Loader II Error Messages."

#### ■ Data Downloading (Block Transfer) Procedure

PROCEDURE	REMARKS
<p> 1. Set the communication mode to GP Transfer.</p>	<p><b>Reference</b> Refer to 3-4-1, "Starting Up GP Transfer Mode."</p>

# Operation

PROCEDURE	REMARKS
<p>2. Use the [Mode] switch to select the operation mode's Download function [Ld-&gt;Gp], and press the [Start] switch to register it.</p> <p>Every time the [Mode] switch is pressed, the operation mode will change.</p> <div data-bbox="300 600 710 678" style="border: 1px solid black; padding: 5px; display: inline-block;">             Ld=Gp? Ld-&gt;Gp           </div> ← Operation mode	<p><b>Note:</b> The operation mode will change in the following order:</p> <div data-bbox="1013 504 1428 683" style="border: 1px solid black; padding: 5px; text-align: center;"> <pre>             Download (Ld -&gt; Gp) → Upload (Gp -&gt; Ld)             End (End) ← Clear (Clear)           </pre> </div>
<p>3. Confirm that you wish to start downloading data.</p> <div data-bbox="300 779 454 857" style="border: 1px solid black; padding: 5px; display: inline-block;">             Ld-&gt;Gp Start?           </div>	<p><b>Note:</b> In order to cancel the data upload operation, press the [Mode] switch, and the GP panel display will return to the operation mode selection screen.</p> <p><b>Important</b>  If the memory card's capacity and GP data size are different, a warning message will appear.</p>
<p>4. Press the [Start] switch to start downloading data.</p> <p>The data size will be displayed on the GP.</p> <div data-bbox="300 1355 933 2007" style="margin-top: 20px;"> <p>Operation mode      Operation status</p> <div style="border: 1px solid black; padding: 5px; margin: 5px 0;">             Ld-&gt;GP ** ****kB           </div> <p style="text-align: center;">↑ Processed data size</p> <div style="border: 1px solid black; padding: 5px; margin: 5px 0;">             Ld-&gt;GP TX ****kB           </div> <div style="border: 1px solid black; padding: 5px; margin: 5px 0;">             Ld-&gt;Gp WT ****kB           </div> <p style="text-align: center;">↓</p> <div style="border: 1px solid black; padding: 5px; margin: 5px 0;">             Ld-&gt;Gp OK ****kB           </div> <p style="text-align: center;">Data reading and writing will be repeated several times.</p> <p style="text-align: center;">Data download is completed.</p> </div>	<div data-bbox="997 1176 1436 1254" style="border: 1px solid black; padding: 5px; margin-bottom: 10px;">             Ld-&gt;Gp S Warn?           </div> ← Warning message

Memory Loader  
Transfer  
\*\*\*\*\*KB Ld->Gp

↓

Memory Loader  
\*\*\*\*\*KB Ld->Gp

PROCEDURE	REMARKS
<p>5. Press the [Start] switch to end data download.</p> <p>The GP panel display will return to the operation mode selection screen.</p> <div style="border: 1px solid black; padding: 5px; display: inline-block; margin-left: 20px;">                     Ld=Gp? Ld-&gt;Gp                 </div> <p style="margin-left: 40px;">← Operation mode</p>	<p> <b>Note:</b> Standard data processing time periods:</p> <p><b>GP-70 Series:</b> approx. 9 minutes</p> <p><b>GP-270 Series:</b> approx. 8 minutes</p> <p><b>GP-571, GP-675:</b> approx. 20 to 25 minutes</p> <p><b>GP-377, GP-377R:</b> approx. 14 minutes</p> <p><b>GP-477R, GP-577R:</b> approx. 20 minutes</p> <p><b>GLC Series:</b> approx. 14 minutes</p> <p><b>GP-230 Series:</b> approx. 4 minutes</p> <p><b>GP-*3J Series:</b> approx. 5 minutes</p> <p><b>GP-*50 Series:</b> approx. 4 to 6 minutes</p> <p><b>CGP Series:</b> approx. 9 minutes</p> <p><b>Easy20 Series:</b> approx. 4 minutes</p> <p><b>Easy40/50 Series:</b> approx. 5 minutes</p> <p> </p> <p> <b>Note:</b> In the case where downloading was abnormally stopped, you can force the transfer of data, if necessary.</p>

### ■ Forced Transfer Procedures

When data which has been uploaded from a GP panel is written to another GP, the Memory Loader II checks the GP panels' model codes, data sizes and system versions to prevent malfunctioning.

If these items do not match, TYPE ERR will be displayed, and data downloading will stop.





Check the data in the Maintenance mode, and if you decide to transfer it forcefully, do so using the following procedures:

**Reference** Refer to 3-6-2 "Data Confirmation."

PROCEDURE	REMARKS
<ol style="list-style-type: none"> <li>1. Turn OFF the GP panel's power.</li> <li>2. Connect the Memory Loader II to the GP panel.</li> <li>3. Turn ON the GP panel's power.</li> </ol>	



# Operation

PROCEDURE	REMARKS
<p>4. Turn ON the Memory Loader II while pressing its [Start] switch.</p> <p>The startup message and the Memory Loader II's version will appear. Then the Memory Loader II will start up.</p> <div style="border: 1px solid black; padding: 5px; width: fit-content; margin-bottom: 10px;">Memory Loader</div> <p style="margin-left: 20px;">← Startup message (approx. 1 second)</p> <p style="text-align: center;">↓</p> <div style="border: 1px solid black; padding: 5px; width: fit-content; margin-bottom: 10px;">Ver*. **</div> <p style="margin-left: 20px;">← Version (approx. 1 second)</p>	<p><b>Note:</b>  Keep pressing the [Start] switch until the operation mode screen is displayed.</p>
<p>5. When the operation mode screen is displayed, release the [Start] switch.</p> <p>Use the [Mode] switch to select Download [Ld -&gt; Gp], and press the [Start] switch to register it.</p> <div style="border: 1px solid black; padding: 5px; width: fit-content; margin-bottom: 10px;">Ld=Gp? Ld-&gt;Gp</div> <p style="margin-left: 20px;">← Operation mode</p>	<p><b>Note:</b>  The operation mode will change in the following order:</p> <div style="border: 1px solid black; padding: 10px; width: fit-content; margin: 10px auto;"> <p style="text-align: center;">Download → Upload (Ld -&gt; Gp)      (Gp -&gt; Ld)</p> <p style="text-align: center;">End ← Clear ← (End)                      (Clear)</p> </div>
<p>6. Use the [Mode] switch to select Forced Transfer [Force], and press the [Start] switch to register it.</p> <div style="border: 1px solid black; padding: 5px; width: fit-content; margin-bottom: 10px;">Ld-&gt;Gp Force?</div> <p style="margin-left: 20px;">← Transfer method</p>	<p><b>Note:</b>  The transfer method will change in the following order:</p> <div style="border: 1px solid black; padding: 10px; width: fit-content; margin: 10px auto;"> <p style="text-align: center;">Normal transfer → Forced transfer (Normal)                      (Force)</p> </div>
<p>7. Confirm that you wish to start downloading data.</p> <div style="border: 1px solid black; padding: 5px; width: fit-content; margin-bottom: 10px;">Ld-&gt;Gp Start?</div>	<p><b>Important</b>  <b>If the memory card's capacity and the GP data size are different, a warning message will appear.</b></p> <div style="border: 1px solid black; padding: 5px; width: fit-content; margin: 10px auto;"> <p>Ld-&gt;Gp S Warn? ← Warning message</p> </div>

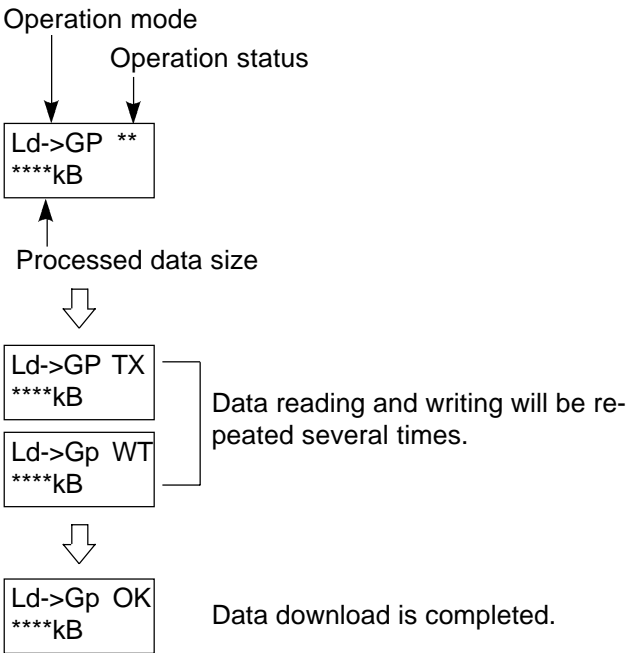
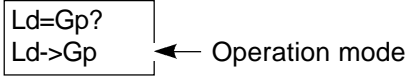
PROCEDURE	REMARKS
<p>8. Press the [Start] switch to start downloading data. The data size will be displayed on the GP.</p> 	<p><b>Note:</b> Standard data processing time periods:</p> <p>GP70 Series: approx. 9 minutes  GP-270 Series: approx. 8 minutes  GP-571, GP-675: approx. 20 to 25 minutes  GP-377, GP-377R: approx. 14 minutes  GP-477R, GP-577R: approx. 20 minutes  GLC Series: approx. 14 minutes  GP-230 Series: approx. 4 minutes  GP-*3J Series: approx. 5 minutes  GP-*50 Series: approx. 4 to 6 minutes  CGP Series: approx. 9 minutes  Easy20 Series: approx. 4 minutes  Easy40/50 Series: approx. 5 minutes</p> <p><b>This display will be repeated several times.</b></p>
<p>9. Press the [Start] switch to end data download. The GP panel will return to the operation mode selection screen.</p> 	<p><b>End the downloading operation with the [Start] switch. The GP panel will return to the operation mode selection screen.</b></p>



**Forced Transfer allows you to transfer the data to a GP with a different system version. To edit the downloaded screen data, however, the data must be edited on and uploaded from the screen creation/editing software of the same version.**

## 4 Downloading Data (Screen Transfer)

Screen data which has been written into the memory card in the Personal Computer Transfer mode will be written to the GP panel.

**Reference** Refer to 3-5-3, “Receiving Data (Screen Transfer).”

When data is written to the GP panel, the communication protocols will be confirmed. If both communication protocols do not match with each other, an error will occur, terminating data downloading.



- **The Screen Transfer function is only compatible with the GP70 Series and CGP Series.**
- **If a Project file with a registered password has been transferred to the GP panel, be sure to register the same password to the screen data to be downloaded from the Memory Loader II. If these passwords are different, you will not be able to download the data.**

### ■ Data Download (Screen Transfer) Procedures

PROCEDURE	REMARKS
 <p>1. Set the communication mode to GP Transfer.</p> <p>2. Use the [Mode] switch to select the operation mode's Download function [Ld -&gt; Gp], and press the [Start] switch to register it.</p> <p>Every time the [Mode] switch is pressed, the operation mode will change.</p> <div style="border: 1px solid black; padding: 5px; display: inline-block;">             Ld=Gp?              Ld-&gt;Gp         </div> <p>← Operation mode</p>	<p><b>Reference</b> Refer to 3-4-1, “Starting Up GP Transfer Mode.”</p> <p><b>Important</b> • <b>In order to download data (Screen Transfer), only the screen data has to be written into the memory card beforehand.</b></p> <p><b>Reference</b> Refer to 3-5-3, “Receiving Data (Screen Transfer).”</p> <p><b>Note:</b> In this case, the Upload operation mode cannot be selected.</p> <pre>             graph TD                 A[Download (Ld -&gt; Gp)] --&gt; B[Clear (Clear)]                 B --&gt; C[End (End)]                 C --&gt; A             </pre>

■ Data Download (Screen Transfer) Procedures

PROCEDURE	REMARKS
<p>3. Confirm that you wish to start downloading data. If the memory card's capacity and GP data size are different, a warning message will appear.</p> <div data-bbox="264 618 416 694" style="border: 1px solid black; padding: 2px; width: fit-content;">                     Ld-&gt;Gp Start?                 </div> <p>4. Press the [Start] switch to start downloading data. The data size will be displayed on the GP.</p> <div data-bbox="264 891 893 1541" style="margin-left: 20px;"> <p>Operation mode      Operation status</p> <div style="border: 1px solid black; padding: 2px; width: fit-content; margin-bottom: 10px;">                         Ld-&gt;GP ** ****kB                     </div> <p style="margin-left: 40px;">↑ Processed data size</p> <div style="display: flex; align-items: center; margin-bottom: 10px;"> <div style="border: 1px solid black; padding: 2px; width: fit-content; margin-right: 10px;">                             Ld-&gt;GP TX ****kB                         </div> <div style="border: 1px solid black; padding: 2px; width: fit-content; margin-right: 10px;">                             Ld-&gt;Gp WT ****kB                         </div> <div style="margin-left: 10px;">                             Data reading and writing will be repeated several times.                         </div> </div> <div style="display: flex; align-items: center; margin-bottom: 10px;"> <div style="border: 1px solid black; padding: 2px; width: fit-content; margin-right: 10px;">                             Ld-&gt;Gp OK ****kB                         </div> <div style="margin-left: 10px;">                             Data download is completed.                         </div> </div> </div> <p>5. Press the [Start] switch to end data downloading. The GP panel display will return to the operation mode selection screen.</p>	<div data-bbox="957 443 1407 705" style="margin-bottom: 20px;"> <p><b>Note:</b> In order to cancel the data upload operation, press the [Mode] switch, and the GP panel display will return to the operation mode selection screen.</p> </div> <div data-bbox="957 734 1407 918" style="margin-bottom: 20px;"> <p><b>Important</b>  Set the GP panel mode to the Screen Data Transfer mode or Run mode.</p> </div> <div data-bbox="957 1209 1407 1702"> <p><b>Note:</b> When data download starts, the following display will appear on the GP:</p> <p style="margin-left: 40px;">Now formatting Please wait.</p> <p style="text-align: center;">↓</p> <p style="margin-left: 40px;">Transferring data Please wait.</p> <p style="text-align: center;">↓</p> <p style="margin-left: 40px;">Writing data Please wait.</p> </div>

## 5 Clearing Memory Card Data

This operation clears the memory card's internal data (initializes the memory card).



**When the memory card's internal data is cleared, all the data stored in the memory card will be erased. In order to avoid the loss of important data, check the data before erasing the memory card.**

### ■ Data Clearing Procedure

PROCEDURE	REMARKS
 <p>1. Set the communication mode to GP Transfer.</p> <p>2. Use the [Mode] switch to select the [Clear] operation mode, and press the [Start] switch to register it.</p> <p>Every time the [Mode] switch is pressed, the operation mode will change.</p> <div style="border: 1px solid black; padding: 5px; display: inline-block;">             Ld=Gp? Clear         </div> <p style="margin-left: 20px;">← Operation mode</p>	<p><b>Note:</b> The Operation mode will change in the following order:</p> <p><b>In the Block Transfer mode:</b></p> <pre>             graph LR                 A[Download (Ld -&gt; Gp)] --&gt; B[Upload (Gp -&gt; Ld)]                 B --&gt; C[Clear (Clear)]                 C --&gt; D[End (End)]                 D --&gt; A             </pre> <p><b>In the Screen Transfer mode:</b></p> <pre>             graph LR                 A[Download (Ld -&gt; Gp)] --&gt; B[Clear (Clear)]                 B --&gt; C[End (End)]                 C --&gt; A             </pre>
<p>3. Confirm that you wish to start clearing data.</p> <div style="border: 1px solid black; padding: 5px; display: inline-block;">             Clear Start?         </div>	<p><b>Note:</b> To cancel the data clearing operation, press the [Mode] switch, and the Memory Loader II's LCD display will return to the operation mode selection screen.</p>

PROCEDURE	REMARKS
<p>4. Press the [Start] switch to clear the memory card's internal data.</p> <p>Operation mode</p> <p>↓</p> <div data-bbox="264 562 416 640" style="border: 1px solid black; padding: 2px; display: inline-block;">Clear ****kB</div> <p>↑</p> <p>Processed data size</p> <p>↓</p> <div data-bbox="264 781 416 860" style="border: 1px solid black; padding: 2px; display: inline-block;">Clear OK ****kB</div> <p style="margin-left: 100px;">Data upload is completed.</p> <p>5. Press the [Start] switch to end data clearing.</p> <p>The Memory Loader II's LCD display will return to the operation mode selection screen.</p> <div data-bbox="264 1055 416 1133" style="border: 1px solid black; padding: 2px; display: inline-block;">Ld=Gp? Clear</div> <p style="margin-left: 20px;">← Operation mode</p>	<p><b>Note:</b> The standard data processing time is approximately 90 seconds when using a 4MB memory card.</p>

## 6 Completing GP Transfer

The Memory Loader II's operation is completed in the GP Transfer mode.

### ■ Procedure for Quitting GP Transfer

PROCEDURE	REMARKS
<p>1. After data uploading, downloading or clearing operations have been completed, the Memory Loader II's LCD display will return to the operation mode selection screen.</p> <div style="border: 1px solid black; padding: 5px; display: inline-block;">                     Ld=Gp? Ld-&gt;Gp                 </div> ← Operation mode <p>2. Use the [Mode] switch to select the [End] operation mode, and press the [Start] switch to register it.</p> <p>The Memory Loader II's LCD display will return to the communication mode selection switch.</p> <div style="border: 1px solid black; padding: 5px; display: inline-block;">                     Mode? Ld=Gp                 </div> ← Communication mode <p>3. Turn OFF the Memory Loader II's power.</p> <p>The Memory Loader II will stop operation and the LCD display's message will disappear.</p> <div style="border: 1px solid black; padding: 5px; display: inline-block;">                     Mode? Ld=Gp                 </div> <p style="text-align: center;">↓</p> <div style="border: 1px solid black; width: 80px; height: 30px; margin: 0 auto;"></div> <p>4. Turn OFF the GP panel's power.</p> <p>5. Disconnect the Memory Loader II from the GP panel.</p>	<p><b>Note:</b> The operation mode will change in the following order:</p> <p><b>In the Block Transfer mode:</b></p> <pre>                     graph LR                         A[Download (Ld -&gt; Gp)] --&gt; B[Upload (Gp -&gt; Ld)]                         B --&gt; C[Clear (Clear)]                         C --&gt; D[End (End)]                         D --&gt; A                     </pre> <p><b>In the Screen Transfer mode:</b></p> <pre>                     graph LR                         A[Download (Ld -&gt; Gp)] --&gt; B[Clear (Clear)]                         B --&gt; C[End (End)]                         C --&gt; A                     </pre>

## 3-5 Personal Computer Transfer

Backup data or screen data is sent or received between the Memory Loader II and a personal computer.

The operating environment for data transfer is as follows. The program to be used will vary depending on the transfer mode used; i.e., Block Transfer or Screen Transfer.

**Reference** Refer to 1-2, "System Configuration."

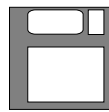

GP-PRO/PB III for Windows  
(ML version 2.0 or later)

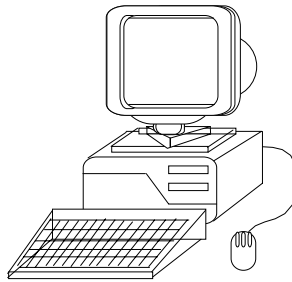

Personal computer

Connecting the RS-232C cross cable to the personal computer's serial interface



RS-232C cross cable

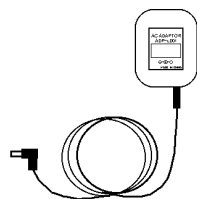

AC adapter

Connecting the AC adapter to the Memory Loader II's external DC input

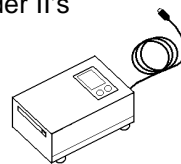

Memory Loader II





Connecting the RS-232C cross cable to the Memory Loader II's personal computer interface



# 1 Start Up Personal Computer Transfer Mode

The procedures for starting up the Memory Loader II and setting the communication mode to Personal Computer Transfer are described.

## ■ Personal Computer Data Transfer Procedures

PROCEDURE	REMARKS
<p>1. Connect the Memory Loader II to the personal computer's serial port.</p> <p>2. Turn ON the Memory Loader II's power.             The startup message and the Memory Loader II's version will appear. Then the Memory Loader II will start up.</p> <div style="display: flex; align-items: center; margin-bottom: 10px;"> <div style="border: 1px solid black; padding: 5px; margin-right: 10px;">Memory Loader</div> <div style="margin-left: 10px;">← Startup message (approx. 1 second)</div> </div> <div style="text-align: center; margin-bottom: 10px;">↓</div> <div style="display: flex; align-items: center; margin-bottom: 10px;"> <div style="border: 1px solid black; padding: 5px; margin-right: 10px;">Ver *.*</div> <div style="margin-left: 10px;">← Version (approx. 1 second)</div> </div> <p>3. Use the [Mode] switch to select the Personal Computer Transfer communication mode [Ld = Pc ], and press the [Start] switch to register it.</p> <p>Every time the [Mode] switch is pressed, the communication mode will change.</p> <div style="display: flex; align-items: center; margin-bottom: 10px;"> <div style="border: 1px solid black; padding: 5px; margin-right: 10px;">Mode? Ld=Pc</div> <div style="margin-left: 10px;">← Communication mode</div> </div> <div style="text-align: center; margin-bottom: 10px;">↓</div> <div style="display: flex; align-items: center; margin-bottom: 10px;"> <div style="border: 1px solid black; padding: 5px; margin-right: 10px;">Ld=Pc? Pc-&gt;Ld</div> <div style="margin-left: 10px;">← Operation mode selection screen</div> </div>	<p> <b>Note:</b> Use the RS-232C cross cable to connect the Memory Loader II and the personal computer.</p> <p> <b>Note:</b> The batteries are only for emergency use. Use the AC adapter that came with the Memory Loader II.</p> <p> <b>Note:</b> The communication mode will change in the following order:</p> <div style="border: 1px solid black; padding: 10px; margin-top: 10px;"> <pre>           graph TD             A[GP Transfer (Ld = Gp)] --&gt; B[Personal Computer Transfer (Ld = Pc)]             B --&gt; C[Maintenance (Maintain)]             C --&gt; A           </pre> </div>

## 2 GP-PRO/PB III for Windows95 Screen Transfer

The screen data can be written to the Memory Loader II from a personal computer. When you are using the GP-PRO/PB III for Windows95 Ver. 2.0 or higher, installation of the add-on software is not required.



**The Screen Transfer function is only compatible with the GP70 Series and CGP Series.**

### Transfer Settings

When using the GP-PRO/PB III for Windows95 software, the [Send To] attribute will appear in the [Transfer Settings] dialog box. Also, some of the attribute data in this dialog box will become fixed.

Designate if upload information used to receive data from a GP panel will be sent.

With this check box checked, the GP system setting information will be always sent.

The GP-PRO/PB III for Windows95 screen transfer add-on software setup will not be performed.

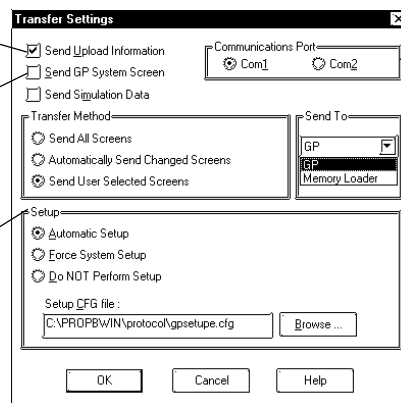

Select the desired serial port for connecting the transfer cable.

Select the desired transfer destination.

### ◆ Send to (transfer destination)

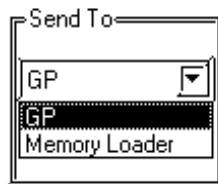

**GP:** Data will be sent or received between the GP-PRO/PB III for Windows95 and a GP panel.

**Memory Loader II:** Data will be sent or received between the GP-PRO/PB III for Windows95 and the Memory Loader II.

### 3 Receiving Data (Screen Transfer)

Screen data is written from the personal computer to the Memory Loader II.

This function can be utilized by GP-PRO/PB III for Windows95 screen transfer software.



**The Screen Transfer function is only compatible with the GP70 Series and CGP Series.**

#### ■ Data Receive (Block Transfer) Procedure



**Prior to receiving data from the personal computer, be sure to clear the memory card's internal data. If data is received when the memory card still contains internal data, an error will occur, and the operation will be terminated.**

**Reference** Refer to 3-5-4, "Clearing Memory Card Data."

PROCEDURE	REMARKS
<div style="display: flex; align-items: flex-start;"> <div style="margin-right: 10px;">  </div> <ol style="list-style-type: none"> <li>1. Set the communication mode to Personal Computer Transfer.</li>   <li>2. Use the [Mode] switch to select the operation mode's Receive function [Pc -&gt; Ld], and press the [Start] switch to register it.  Every time the [Mode] switch is pressed, the operation mode will change.   <div style="border: 1px solid black; padding: 5px; display: inline-block; margin-right: 10px;">                     Ld=Pc? Pc-&gt;Ld                 </div>                     ← Operation mode                 </li>   <li>3. Confirm that you wish to start uploading data.   <div style="border: 1px solid black; padding: 5px; display: inline-block; margin-right: 10px;">                     Pc-&gt;Ld Start?                 </div> </li> </ol> </div>	<p><b>Reference</b> Refer to 3-5-1, "Start Up Personal Computer Transfer Mode."</p> <p><b>Note:</b> The operation mode will change in the following order:</p> <div style="text-align: center; margin: 10px 0;"> <pre>                     graph TD                         A[Download (Pc -&gt; Ld)] --&gt; B[Upload (Ld -&gt; Pc)]                         B --&gt; C[Clear (Clear)]                         C --&gt; D[End (End)]                         D --&gt; A                     </pre> </div> <p><b>Note:</b> In order to cancel the data upload operation, press the [Mode] switch, and the GP panel display will return to the operation mode selection screen.</p>

**PROCEDURE**

**REMARKS**



4. Open the [Transfer] dialog box on the GP-PRO/PB III for Windows95 software.

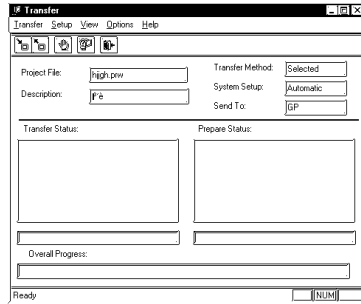

5. Either select [Transfer Settings] from the [Setup] menu, or click on .

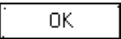

6. Designate “Memory Loader” as the transfer destination from the [Send To] dialog box under [Transfer Settings], and click on the  to register it.

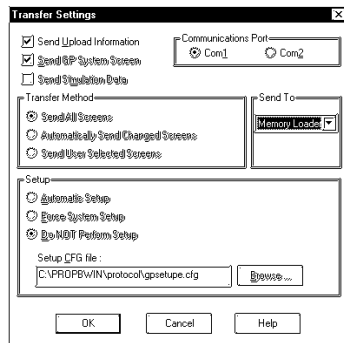





**Note:** When [Send To] (transfer destination) has been designated as “Memory Loader”, all of the [Transfer Settings] dialog box’s attributes, excluding “Send Upload Information”, “Communications Port”, and “Send To”, will become fixed.

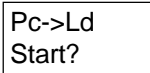





7. Press the [Start] switch, and the personal computer will enter transfer stand-by status.

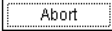

## Operation

PROCEDURE	REMARKS
<p>8. Either select [Send] from the [Transfer] menu, or click on the Tool Bar's  to start sending data.</p> <p>If the currently open project file has not been prepared (compiled) for screen transfer, its screen data will automatically be prepared for transfer to a GP panel.</p> <div style="text-align: center;">  <p>↓</p>  </div> <div style="display: flex; align-items: center;">  <div style="border: 1px solid black; padding: 5px; width: 100px;">             Pc-&gt;Ld **              ****kB           </div> </div> <p style="text-align: center;">↑</p> <p style="text-align: center;">Processed data size</p> <p style="text-align: center;">↓</p> <div style="display: flex; align-items: center;"> <div style="border: 1px solid black; padding: 5px; width: 100px;">             Pc-&gt;Ld RX              ****kB           </div> <div style="border: 1px solid black; padding: 5px; width: 100px; margin-left: 10px;">             Pc-&gt;Ld WT              ****kB           </div> <div style="margin-left: 10px;"> <p>⌋</p> <p>Data reading and writing will be repeated several times.</p> </div> </div> <p style="text-align: center;">↓</p> <div style="display: flex; align-items: center;"> <div style="border: 1px solid black; padding: 5px; width: 100px;">             Pc-&gt;Ld OK              ****kB           </div> <div style="margin-left: 10px;"> <p>Data receive has been completed.</p> </div> </div> <p>9. Press the [Start] switch to terminate data receive.</p> <p>The Memory Loader II's LCD display will return to the operation mode selection screen.</p> <div style="display: flex; align-items: center;"> <div style="border: 1px solid black; padding: 5px; width: 100px;">             Ld=Pc?              Pc-&gt;Ld           </div> <div style="margin-left: 10px;"> <p>← Operation mode</p> </div> </div>	<p><b>Reference</b> Refer to the <i>GP-PRO/PB III for Windows95 Operation Manual</i>, 7-2-3, "Transfer Preparation."</p> <p>To abort screen transfer, click on .</p>

PROCEDURE	REMARKS
<p>10. Click on .</p>  <p>11. Either select [Exit] from the [Transfer] menu, or click on the Tool Bar's .</p> 	

## 4 Clearing Memory Card Data

The memory card's internal data will be cleared; i.e., the memory card will be initialized.

**Note:** The memory card's internal data can also be cleared in the GP Transfer mode.

**Reference** Refer to 3-4-5, "Clearing Memory Card Data."

### ■ Data Clear Procedure

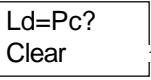
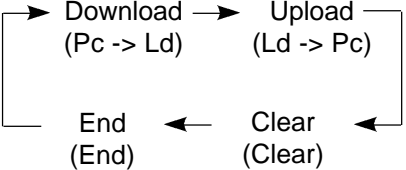
PROCEDURE	REMARKS
<p>1. Set the communication mode to Personal Computer Transfer.</p> <p>2. Use the [Mode] switch to select the [Clear] operation mode, and press the [Start] switch to register it.</p> <p>Every time the [Mode] switch is pressed, the operation mode will change.</p>  <p>← Operation mode</p>	<p><b>Reference</b> Refer to 3-5-1, "Start Up Personal Computer Transfer Mode."</p> <p><b>Note:</b> The operation mode will change in the following order:</p> 

## Operation

PROCEDURE	REMARKS
<p>3. A screen to confirm your desire to start clearing data will appear.</p> <div style="border: 1px solid black; padding: 5px; width: fit-content; margin-bottom: 10px;">Clear Start?</div> <p>4. Press the [Start] switch to start clearing data.</p> <p>Operation mode</p> <p style="text-align: center;">↓</p> <div style="border: 1px solid black; padding: 5px; width: fit-content; margin-bottom: 10px;">Clear ****kB</div> <p style="text-align: center;">↑</p> <p>Processed data size</p> <p style="text-align: center;">↓</p> <div style="border: 1px solid black; padding: 5px; width: fit-content; display: inline-block;">Clear OK ****kB</div> Data clear is completed. <p>5. Press the [Start] switch to terminate data clear.</p> <p>The Memory Loader II's LCD display will return to the operation mode selection screen.</p> <div style="border: 1px solid black; padding: 5px; width: fit-content; display: inline-block;">Ld=Pc? Pc-&gt;Ld</div> ← Operation mode	<p> <b>Note:</b> In order to cancel the data upload operation, press the [Mode] switch, and the GP panel display will return to the operation mode selection screen.</p>

## 5 Completing Personal Computer Transfer

The Memory Loader II's operation is terminated in the Personal Computer Transfer mode.

### ■ Procedure for Quitting Personal Computer Transfer

PROCEDURE	REMARKS
<p> 1. After data receiving, sending or clearing operations have been completed, the Memory Loader II's LCD display will return to the operation mode selection screen.</p> <div style="border: 1px solid black; padding: 5px; width: fit-content; display: inline-block;">Ld=Pc? Pc-&gt;Ld</div> ← Operation mode	

PROCEDURE	REMARKS
<p>2. Use the [Mode] switch to select the [End] operation mode, and press the [Start] switch to register it.</p> <p>The Memory Loader II's LCD display will return to the communication mode selection screen.</p> <div data-bbox="264 607 671 685" style="border: 1px solid black; padding: 5px; display: inline-block;">             Ld=Pc? End         </div> ← Operation mode <p>3. Turn OFF the Memory Loader II's power.</p> <p>The Memory Loader II's operation will stop, and the LCD display's message will disappear.</p> <div data-bbox="264 869 740 947" style="border: 1px solid black; padding: 5px; display: inline-block;">             Mode? Ld=Gp         </div> ← Communication mode <p style="text-align: center;">↓</p> <div data-bbox="264 1021 416 1099" style="border: 1px solid black; width: 100px; height: 35px; margin: 0 auto;"></div> <p>4. Turn OFF the GP panel's power.</p> <p>5. Disconnect the Memory Loader II from the GP panel.</p>	<p><b>Note:</b> The operation mode will change in the following order:</p> <div data-bbox="970 510 1378 685" style="border: 1px solid black; padding: 10px; text-align: center;"> <pre>             graph TD                 A[Download (Pc -&gt; Ld)] --&gt; B[Upload (Ld -&gt; Pc)]                 B --&gt; C[Clear (Clear)]                 C --&gt; D[End (End)]                 D --&gt; A             </pre> </div>



## 3-6 Maintenance

These modes are used to diagnose the Memory card unit and Memory Loader II.

### 1 Starting Up Maintenance Mode

The procedures for starting up the Memory Loader II and setting the communication mode to Maintenance mode are described.

#### ■ Maintenance Procedure

PROCEDURE	REMARKS
<div style="display: flex; align-items: flex-start;"> <div style="margin-right: 10px;">  </div> <div> <p>1. Turn ON the Memory Loader II's power.</p> <p>The startup message and the Memory Loader II's version will appear. Then the Memory Loader II will start up.</p> <div style="margin-left: 20px;"> <div style="border: 1px solid black; padding: 2px; display: inline-block;">Memory Loader</div> ← Startup message (approx. 1 second)                     </div> <p style="text-align: center;">↓</p> <div style="margin-left: 20px;"> <div style="border: 1px solid black; padding: 2px; display: inline-block;">Ver*. **</div> ← Version (approx. 1 second)                     </div> </div> <p>2. Use the [Mode] switch to select the maintenance communication mode [Maintain], and press the [Start] switch.</p> <p>Every time the [Mode] switch is pressed, the communication mode will change.</p> <div style="margin-left: 20px;"> <div style="border: 1px solid black; padding: 2px; display: inline-block;">Mode? Maintain</div> ← Communication mode                     </div> <p style="text-align: center;">↓</p> <div style="margin-left: 20px;"> <div style="border: 1px solid black; padding: 2px; display: inline-block;">Maint? Data</div> ← Operation mode                     </div> </div>	

\*1 This function is available only with GP-PRO/PB III for Window95 Ver. 2.0 or higher.

## 2 Data Confirmation

Data stored inside the memory card can be displayed to confirm the contents.

### ■ Data Confirmation Procedure



PROCEDURE	REMARKS
<p>1. Set the communication mode to the Maintenance mode.</p> <p>2. Use the [Mode] switch to select the data confirmation operation mode [Data].</p> <p>Every time the [Mode] switch is pressed, the operation mode will change.</p> <div style="border: 1px solid black; padding: 5px; display: inline-block;">             Maint? Data         </div> ← Operation mode <p>3. Press the [Start] switch to start data confirmation.</p> <p>Every time the [Mode] switch is pressed, the items displayed will change.</p> <div style="display: flex; flex-direction: column; align-items: flex-start;"> <div style="margin-bottom: 10px;"> <div style="border: 1px solid black; padding: 5px; display: inline-block;">                     ***** *****                 </div> ← GP type             </div> <div style="margin-bottom: 10px;"> <div style="border: 1px solid black; padding: 5px; display: inline-block;">                     ***** *****                 </div> ← Version             </div> <div style="margin-bottom: 10px;"> <div style="border: 1px solid black; padding: 5px; display: inline-block;">                     No. ** ****kB                 </div> ← Model No. ← Data size             </div> <div style="margin-bottom: 10px;"> <div style="border: 1px solid black; padding: 5px; display: inline-block;">                     ID ** *****                 </div> ← Core ID ← PLC type             </div> </div>	

 Maint?  
Data

### 3 Self-diagnosis

The Memory Loader II's self-diagnosis function is able to carry out the following eight checks:

SRAM check: SRAM read/write check

FEPRM check: FEPRM checksum check

Memory card check: Memory card read/write check

GP interface loop back check: Loop back check for Mini D-Sub Connector Din 8-pin type cable

Personal computer interface loop back check: Loop back check for D-sub 25-pin type cable

Battery check: Low power supply voltage check



Switch input check: Input check for [Start] and [Mode] switches

LCD display check: LCD display pattern check

#### ■ Self-diagnosis Procedure

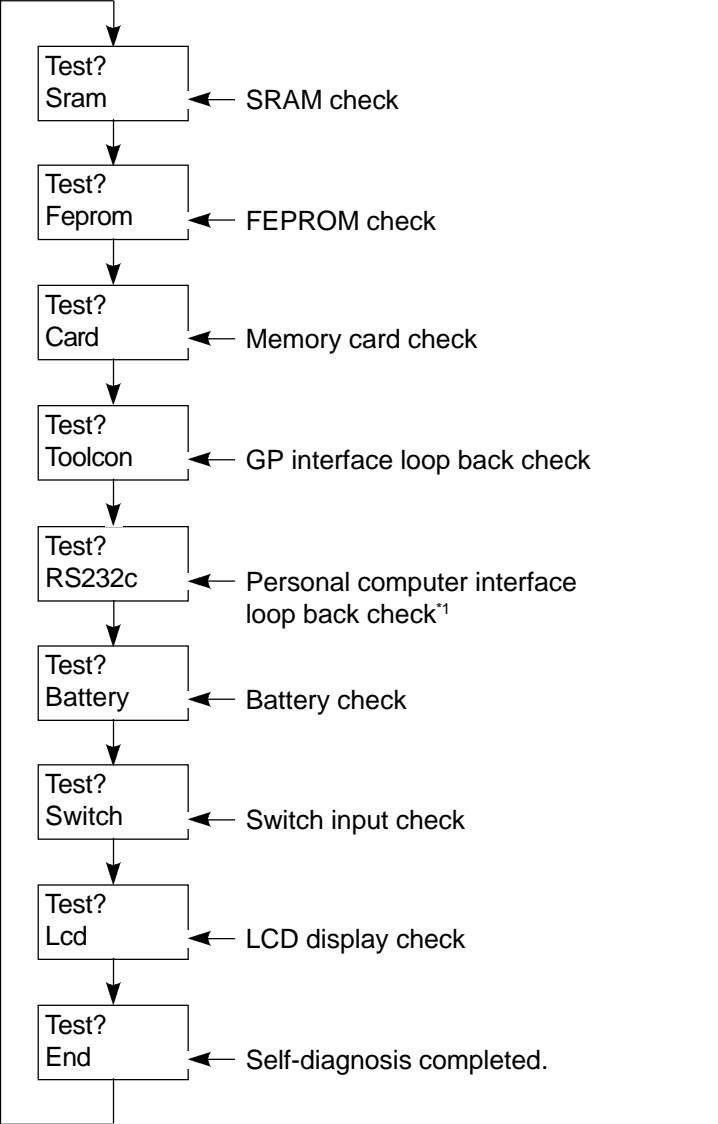

PROCEDURE	REMARKS
<p>1. Set the communication mode to the Maintenance mode.</p> <p>2. Use the [Mode] switch to select the self-diagnosis operation mode [Test], and press the [Start] switch to register it.</p> <p>Every time the [Mode] switch is pressed, the operation mode will change.</p> <div style="border: 1px solid black; padding: 5px; display: inline-block;">             Maint? Test         </div> <p style="margin-left: 20px;">← Operation mode</p>	<p><b>Reference</b> Refer to 3-6-1, "Starting Up Maintenance Mode."</p> <p><b>Note:</b> The operation mode will change in the following order:</p> <div style="border: 1px solid black; padding: 10px; margin: 10px 0;"> <pre>             graph LR             A[Data confirmation (Data)] --&gt; B[Self-diagnosis (Test)]             B --&gt; C[End (End)]             C --&gt; A             </pre> </div>

PROCEDURE	REMARKS
<p>3. Use the [Mode] switch to select the desired self-diagnosis item.</p> <p>Every time the [Mode] switch is pressed, the self-diagnosis item will change.</p>  <pre> graph TD     Sram[Test? Sram] --&gt; Feprom[Test? Feprom]     Feprom --&gt; Card[Test? Card]     Card --&gt; Toolcon[Test? Toolcon]     Toolcon --&gt; RS232c[Test? RS232c]     RS232c --&gt; Battery[Test? Battery]     Battery --&gt; Switch[Test? Switch]     Switch --&gt; Lcd[Test? Lcd]     Lcd --&gt; End[Test? End]     End --&gt; Sram     </pre>	<p> <b>Important</b> When the memory card check is performed, the memory card's internal data will be cleared.</p> <p><b>Reference</b> Refer to <b>Memory Card Check.</b></p> <p><b>Reference</b> Refer to <b>Loop Back Check.</b></p> <p><b>Reference</b> Refer to <b>Battery Check.</b></p> <p><b>Reference</b> Refer to <b>Switch Input Check.</b></p> <p><b>Reference</b> Refer to <b>LCD Display Check.</b></p>

\*1 This feature is available only with GP-PRO/PB III for Window95 ML Ver. 2.0 or higher.

## Operation

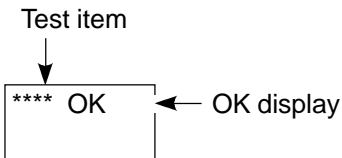
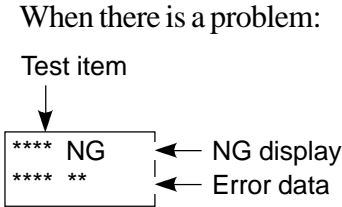
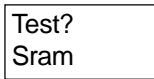
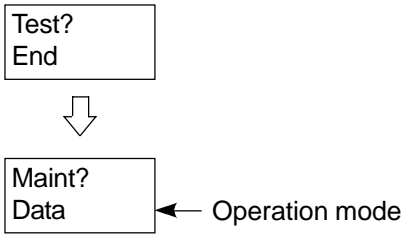
PROCEDURE	REMARKS
<p>4. Press the [Start] switch to start the self-diagnosis.</p> <p>Depending on the self-diagnosis results, [OK] or [NG] will be displayed.</p> <p>When there is no problem:</p> <p>Test item</p>  <p>When there is a problem:</p> <p>Test item</p> 	
<p>5. Press the [Start] switch to terminate the self-diagnosis.</p> <p>The Memory Loader II's LCD display will return to the self-diagnosis item selection screen.</p> 	<p><b>Note:</b> When carrying out a switch input check, the self-diagnosis operation is terminated by pressing the [Start] and [Mode] switches simultaneously. This is the only check which is terminated in this way.</p>
<p>6. Use the [Mode] switch to select [End], and press the [Start] switch to terminate the self-diagnosis.</p> <p>The Memory Loader II's LCD display will return to the operation mode selection switch.</p> 	<p><b>Reference</b> Refer to  <b>Switch Input Check.</b></p>

■ **Loop Back Check**

Each connector's control line and data send/receive line is checked.

◆ **GP interface loop back check**

GP interface loop back check is performed by connecting the GP interface loop back cable to the GP interface.

GP interface loop back cable (Mini D-Sub Connector Din 8-pin socket type)

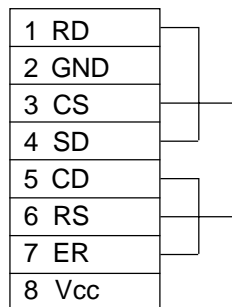

◆ **Personal computer interface loop back check**

The personal computer interface loop back check is performed by connecting the personal computer interface loop back cable to the personal computer interface.

Personal computer interface loop back cable (D-sub 25-pin socket type)

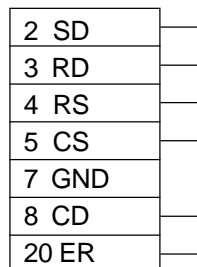

■ **Battery Check**

This check diagnoses the voltage level of the batteries to see if it is too low.

Batt OK

The battery voltage is appropriate.

Batt NG

Replace the batteries.

Batt Low

The battery charge is low.

Batt Adp

The AC adapter is being connected.

## ■ LCD Display Check

When using the LCD Display Check feature, when the display check starts, the alphabet characters displayed will be automatically shifted either up or down.

DEFGHIJK

The display shifts to show  
"ABCDEFGHIJKLMNOPQRSTUVWXYZ."



LCD TEST  
COMPLETE

LCD display check completed.

## ■ Switch Input Check

When the switch input check starts, the following display will appear. To perform this check, press either the [Mode] switch or [Start] switch to check if their input is correct. Pressing the [Mode] and [Start] switches simultaneously terminates this check.

When switch input is functioning normally:

Switch  
\*\*\*\*\*

Pressing the [Mode] switch displays [MODE].  
Pressing the [Start] switch displays [START].

## 4 Quitting Maintenance Mode

These procedures show how to quit the Memory Loader II's Maintenance mode.

### ■ Maintenance Mode Quitting Procedure

PROCEDURE	REMARKS
 <p>1. After the maintenance operation has been completed, the Memory Loader II's LCD display will return to the operation mode selection screen.</p> <div style="border: 1px solid black; padding: 5px; display: inline-block;">             Maint? Data           </div> <p>← Operation mode</p>	

PROCEDURE	REMARKS
<p>2. Use the [Mode] switch to select the [End] operation mode, and press the [Start] switch to register it.</p> <p>The Memory Loader II's LCD display will return to the communication mode selection screen.</p> <div data-bbox="264 600 667 678" style="border: 1px solid black; padding: 5px; display: inline-block;">             Maint? End           </div> <p style="margin-left: 20px;">← Operation mode</p> <p>3. Turn OFF the Memory Loader II's power.</p> <p>The Memory Loader II's operation will stop, and the LCD display's message will disappear.</p> <div data-bbox="264 864 735 943" style="border: 1px solid black; padding: 5px; display: inline-block;">             Mode? Ld=Gp           </div> <p style="margin-left: 20px;">← Communication mode</p> <div style="text-align: center; margin-top: 10px;">   <div data-bbox="264 1016 416 1095" style="border: 1px solid black; width: 80px; height: 30px; margin: 0 auto;"></div> </div>	<p><b>Note:</b> The operation mode will change in the following order:</p> <div data-bbox="970 504 1380 689" style="border: 1px solid black; padding: 10px; margin: 10px 0;"> <pre>             graph LR               A[Data confirmation (Data)] --&gt; B[Self-diagnosis (Test)]               B --&gt; C[End (End)]               C --&gt; A           </pre> </div>



# 4 Error Messages

## 4-1 Error Messages

### 4-1 Error Messages

If the Memory Loader II's communication ends abnormally, error messages will appear on the Memory Loader II.

#### 1 Memory Loader II Error Messages

Error messages displayed on the Memory Loader II's LCD display are listed here.

```
Ld->Gp NG
*****
```

← Error message

Error Message	Error Type	Causes	Countermeasures
Cd1 Err	Memory card error	Data uploading or receiving was performed with the memory card uninitialized.	Initialize the memory card, and try again.
		Downloading was attempted from an empty memory card.	First, upload or receive data into the memory card, and then download data.
Cd2 Err		A memory card other than the one designated in this manual was used.	Use the designated one.
Cd3 Err		The Memory Loader II was operated without inserting the memory card.	Insert the memory card.
Cd4 Err		When uploading data, the GP data size exceeded the memory card capacity.	Check the GP data size, and use a memory card with enough space.
Cd5 Err		Data uploading, receiving or clearing was attempted while the memory card is write-protected.	Undo write protect, and try again.
Cd6 Err		Data reading/writing into the memory card was not performed correctly.	Initialize the memory card, and try again.
Type Err	GP model incompatible	When downloading data, the memory card's internal data and download destination GP's model or protocol did not match.	Perform memory card data confirmation in the Maintenance mode, and check the download destination GP's model.

## Error Messages

Error Message	Error Type	Causes	Countermeasures
Pass Err	Different password <sup>*1</sup>	When screen data was downloaded to the GP70 Series, the passwords registered in the GP and the GP-PRO/PB III for Windows95 software were different.	Check these passwords, and match them.
Tx1 Err	Communication data/ command error <sup>*1</sup>	While the Memory Loader II was communicating with the GP panel or personal computer, the cable was disconnected (and connected again).	After turning OFF the Memory Loader II's power, try again.
		While the Memory Loader II was communicating with the GP panel or personal computer, the personal computer's power was turned OFF, and then ON.	After turning OFF the Memory Loader II's power, try again.
Tx2 Err	Communication error 2 <sup>*1</sup>	While the Memory Loader II was communicating with the GP panel or personal computer, the cable was disconnected (and connected again).	After turning OFF the Memory Loader II's power, try again.
	Parity overrun framing error <sup>*1</sup>	While the Memory Loader II was communicating with the GP panel or personal computer, the personal computer's power was turned OFF, and then ON.	After turning OFF the Memory Loader II's power, try again.
HS Err	Communication error 3 <sup>*1</sup>	While the Memory Loader II was communicating with the GP panel or personal computer, the cable was disconnected (and connected again).	After turning OFF the Memory Loader II's power, try again.
	HS link error	While the Memory Loader II was communicating with the GP panel, the GP panel's power was turned OFF, and then ON.	After turning OFF the Memory Loader II's power, try again.
Gp Err**	GP panel data writing error	When data was downloaded, data could not be written to the GP panel correctly.	After turning OFF the Memory Loader II's power, try again.
Batt Err	Memory Loader II power supply voltage lowered	The battery power supply voltage dropped.	Either replace the batteries or connect the AC adapter, and try again.
Size Err	Data size discrepancy	When data was downloaded, the GP's data size was smaller than the memory card's internal data size.	Check the memory card's data size in the Maintenance mode, and download data to the applicable GP.

<sup>\*1</sup> This feature is available only with GP-PRO/PB III for Windows ML Ver. 2.0 or higher.