

# LT Type H I/O Setting User Manual

# PREFACE

---

Thank you for purchasing Pro-face's LT Type H Series unit, hereafter referred to as the "LT" or the "LT unit". This unit, which utilizes Pro-face's newest PC architecture, is equipped with a wide range of standard-equipment interfaces and is designed for use in a wide variety of industrial applications.

Prior to using the LT unit, be sure to read this manual thoroughly to familiarize yourself with the unit's operation procedures and functions.

**< Note >**

1. It is forbidden to copy the contents of this manual in whole, or in part, without the permission of the Digital Electronics Corporation.
2. The information in this manual is subject to change without notice.
3. This manual was written with care; however, if you should find any errors or omissions, please contact Pro-face and inform them of your findings.
4. Please be aware that Digital Electronics Corporation shall not be held liable by the user for any damages, losses, or third party claims arising from the uses of this product.

Product names used in this manual are the trademarks of their respective manufacturers.

© Copyright 2002 Digital Electronics Corporation. All rights reserved.





# DOCUMENTATION CONVENTIONS

---

This manual uses the following symbols and terminology.





## ■ Safety Symbols and Terms

This manual uses the following symbols and terms to identify important information related to the correct and safe operation of this product.

Symbol	Description
	Indicates a potentially hazardous situation that could result in serious injury or death.
	Indicates a potentially hazardous situation that could result in minor injury or equipment damage.
	Indicates a potentially damaging action or dangerous situation that could result in abnormal equipment operation or data loss.
	Indicates instructions or procedures that must be performed to ensure correct product use.
	Indicates instructions or procedures that must not be performed.

## ■ General Information Symbols and Terms

This manual uses the following symbols and terms for general information.

Symbol	Description
	Provides hints on correct product use, or supplementary information.
	Indicates an item's related information (manual name, chapter, section, sub-section).
	Refers to keys on the computer keyboard.  <b>Keyboard Compatibility List</b>
Device	Indicates peripheral devices such as temperature controllers, inverters, etc. connected via serial I/O. It does not include devices connected via the Flex Network or DIO.
LT	Generic name for the "LT Series" Graphic Logic Controller made by Digital Electronics Corporation.
LT Editor	Indicates Digital Electronics Corporation's LT integrated development software "LT Editor" Version 2.0 (this product).

# TABLE OF CONTENTS

<b>PREFACE .....</b>	<b>1</b>
<b>DOCUMENTATION CONVENTIONS .....</b>	<b>2</b>
<b>TABLE OF CONTENTS .....</b>	<b>3</b>
<b>CHAPTER 1 OVERVIEW</b>	
<b>1.1 System Configuration .....</b>	<b>1-1</b>
<b>1.2 I/O Types .....</b>	<b>1-2</b>
<b>CHAPTER 2 I/O SETTINGS</b>	
<b>2.1 Interface Specifications .....</b>	<b>2-1</b>
<b>2.2 I/O Settings .....</b>	<b>2-5</b>
2.2.1 Overview .....	2-5
2.2.2 I/O Allocation (General) .....	2-6
2.2.3 DIN .....	2-22
2.2.4 DOUT .....	2-24
2.2.5 High-Speed Counter (General Use) .....	2-25
2.2.6 High-Speed Counter (Single-Phase Setting) .....	2-27
2.2.7 High-Speed Counter (two-phase).....	2-50
2.2.8 PWM Output .....	2-55
2.2.9 Normal Pulse Output .....	2-63
2.2.10 Acceleration/Deceleration Speed Pulse Output .....	2-71
2.2.11 Analog Input .....	2-86
2.2.12 Analog Output .....	2-89
2.2.13 Thermocouple Input .....	2-91
2.2.14 Pt100 Input .....	2-96
<b>CHAPTER 3 ERROR MESSAGES</b>	

# *Memo*

# Chapter 1 Overview

## 1.1 System Configuration

This section shows the standard peripheral devices and I/O interfaces that can be connected to the LT unit.

### ■ System Design

#### LT Unit (Type H)

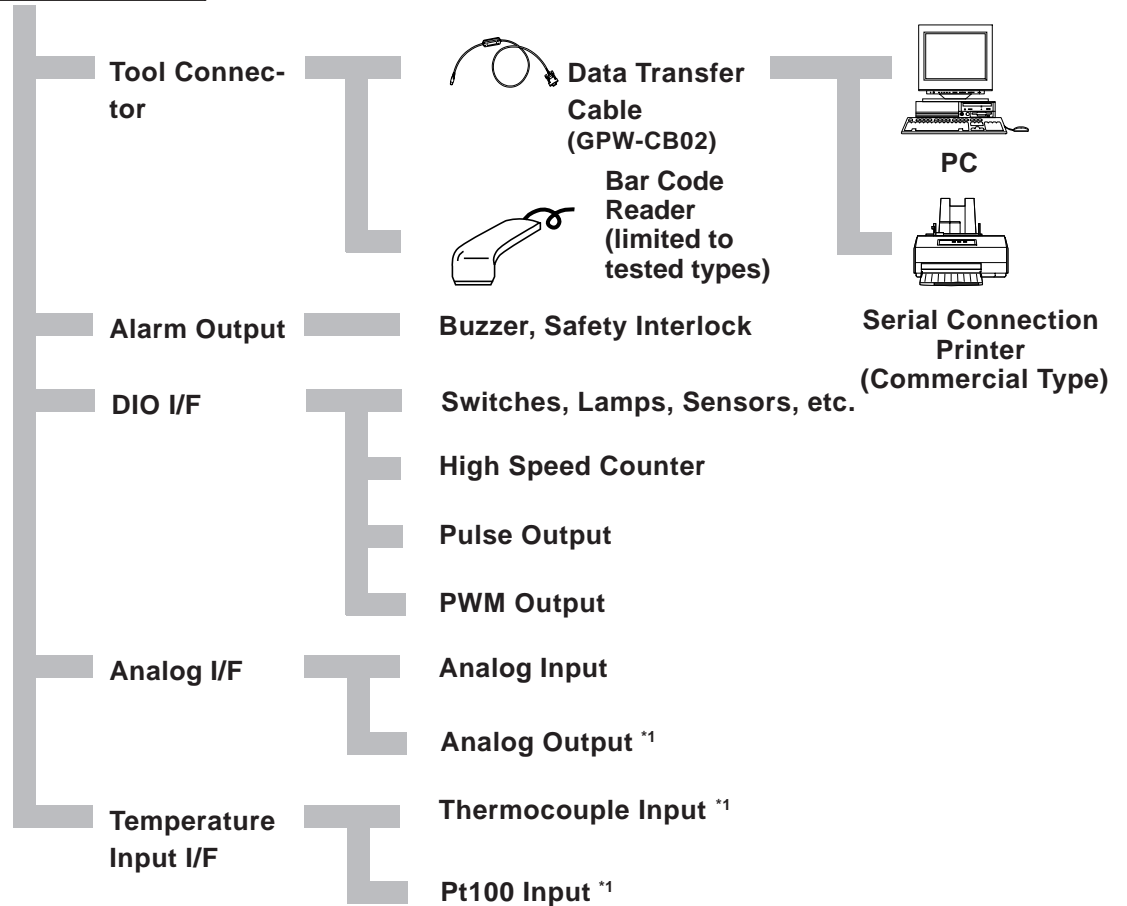
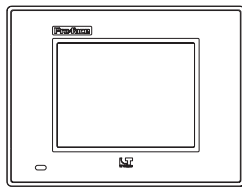

\*1 The I/O specifications will vary depending on the model of LT Type H unit used.

## 1.2 I/O Types

### ■ Maximum number of I/O Points

Depending on the type of I/O used, the number of points available will vary.

	I/O Type	Type H-AD	Type H-ADP	Type H-ADT
Standard Input	DIO	16	16	16
Standard Output(200mA)		8	8	8
Standard Output(500mA)		8	8	8
PWM Output <sup>*1</sup>	Special I/O	4	4	4
Pulse Output <sup>*1</sup>		4	4	4
High-Speed Counter <sup>*1*2</sup>		4	4	4
Analog Input	Analog I/O	2	2	2
Analog Output		1	2	2
Thermocouple Input	Temperature Input	-	-	3
Pt100 Input		-	2	-

### ■ DIO and Special I/O Allocation

Regardless of the I/O type, DIO terminal settings can be performed using the [Group Terminal Settings]. The characteristics of each I/O type is as follows:

#### ◆ DIO

Standard I/O	Input	Output
		Standard Input

#### ◆ Special I/O

	Input	Output
Single-phase counter	Counter Input	Synch. Output
	Preload Input	
	Prestrobe Input	
2-phase counter	Counter Input 1A	Synch. Output
	Counter Input 1B	
	Counter Input 1Z (Marker Input)	
PWM		PWM Output
Pulse		Pulse Output

*\*1 Since the I/O terminals for the Standard Input, Standard Output, PWM Output, Pulse Output and High-Speed Counter I/O are common, it will not be possible to simultaneously use the maximum number of each of these units.*

*\*2 When using 2-phase Counters, the maximum number of counters that can be used is one 2-phase Counter and two Single-phase Counters.*

## ■ DIO Terminal Settings

As shown in the drawing below, this unit's terminals X8 to X15 are reserved just for Input, and terminals Y4 to Y15 are reserved just for Output. Terminals from X0 to X7 and from Y0 to Y3 are designed as [Group Terminal Settings]. These [Group Terminal Settings] can be assigned for DIO and Special I/O.

For details, **Reference** [2.2.2 I/O Allocation \(General\)](#) ■ *Setting Normal I/O, High-Speed Counter, PWM Output and Pulse Output*

X15	X14	X13	X12	X11	X10	X9	X8	X7	X6	X5	X4	X3	X2	X1	X0
Y15	Y14	Y13	Y12	Y11	Y10	Y9	Y8	Y7	Y6	Y5	Y4	Y3	Y2	Y1	Y0

As shown below, each group consists of 2 input terminals and 1 output terminal, which is set as a unit. The following figures show the arrangement of each group.

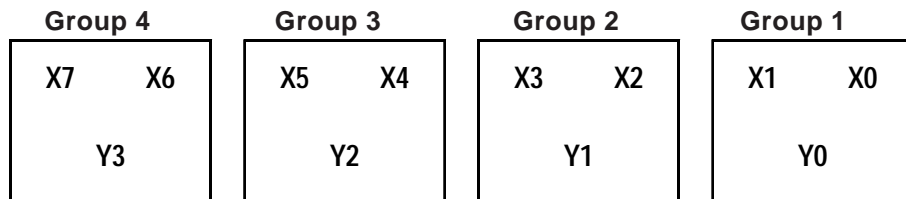



# *Memo*

# Chapter

## 2 I/O Settings

This chapter presents an overview and description of the functions of the driver software for the LT Type H. It also describes how to use LT Editor software to set these functions.

### 2.1 Interface Specifications

---

#### ■ I/O Board Overview

As shown in the block diagram below, in response to control instructions from the LT, a variety of I/O control is performed. All instructions and I/O board data is received via I/F RAM.

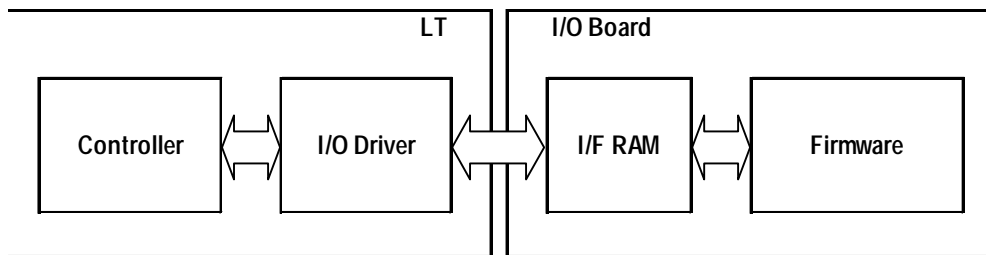

## ◆ I/O Board Processing Flow

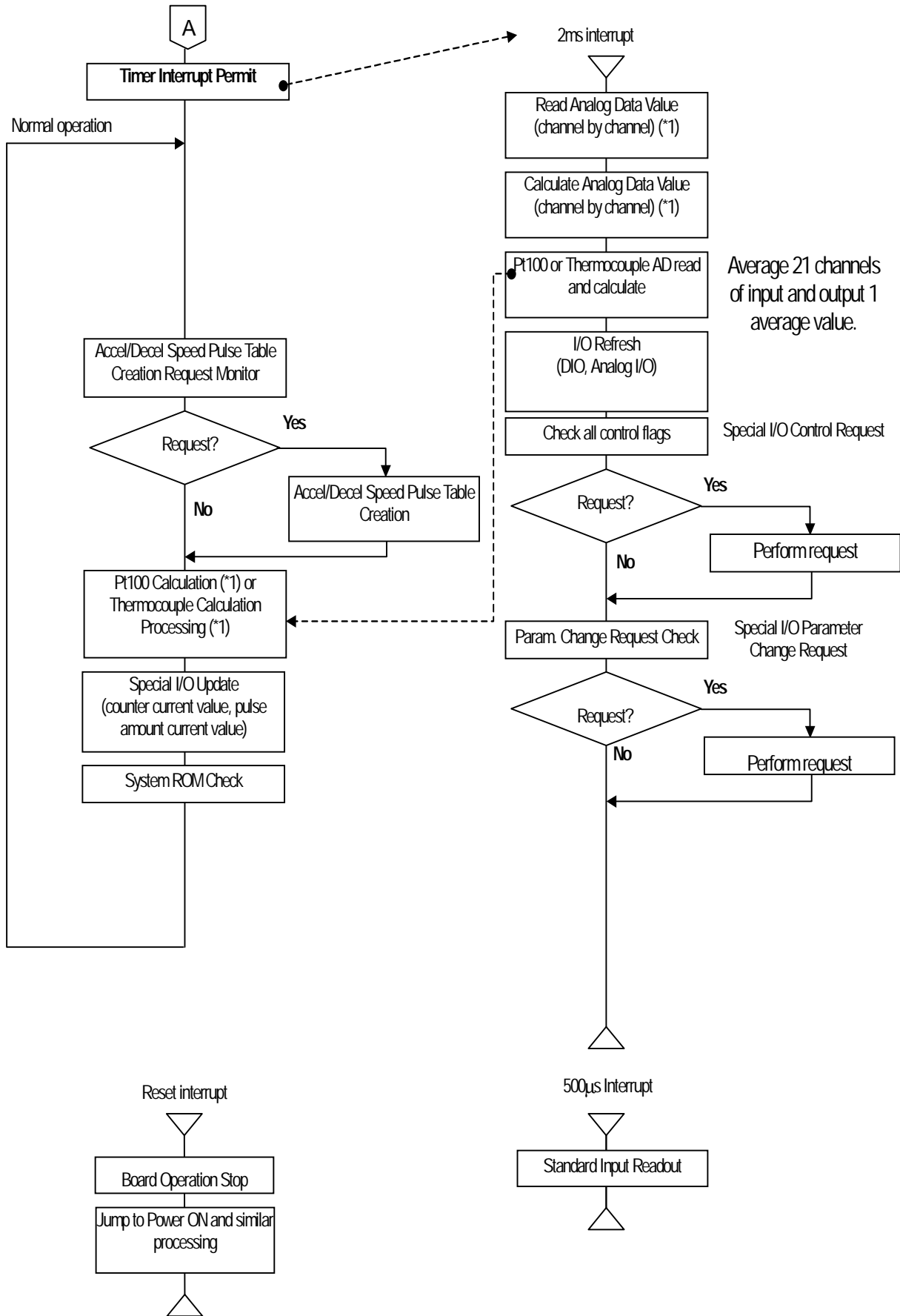

IFR: I/F RAM

\*1 Depending on I/O Board type, this may not be possible to do.

### ◆ I/O Board Processing Flow

I/O Board processing is normally updating I/O data and performing special I/O control in response to LT unit requests. This processing usually consists of special I/O interrupt processing, 0.5ms processing, 2ms processing, then normal processing.

For example, if during 2ms processing a special I/O interrupt processing request is received, the 2ms processing is stopped and the interrupt processing is performed.

Processing	Item	Description
Special I/O Interrupt	Special I/O Processing	(Counter synch. output control)
		(Counter preload input processing)
		(Counter pre-strobe input processing)
		(2-phase counter mark input processing)
		(Output pulse amount control)
		(Accel/Decel speed pulse table switching)
0.5ms interval	Input terminal status data storage	
2ms interval	Standard I/O update	
	Analog I/O update	
	Pt100/Thermocouple input storage	
	Special I/O control monitor	Special I/O start/stop
	Special I/O parameter change monitor	Special I/O parameter change
	Special I/O counter input special request monitor	Counter value clear
		(Synch. output clear)
		(Counter value readout)
(Counter value write)		
Normal operation	Accel/Decel speed pulse table creation	
	Pt100/Thermocouple input update	
	Special I/O update	Current counter value
		Pulse output amount current value
	System ROM check	

### ◆ When only DIO, Analog I/O, Temperature Input are used

Each type of processing is usually performed simultaneously.

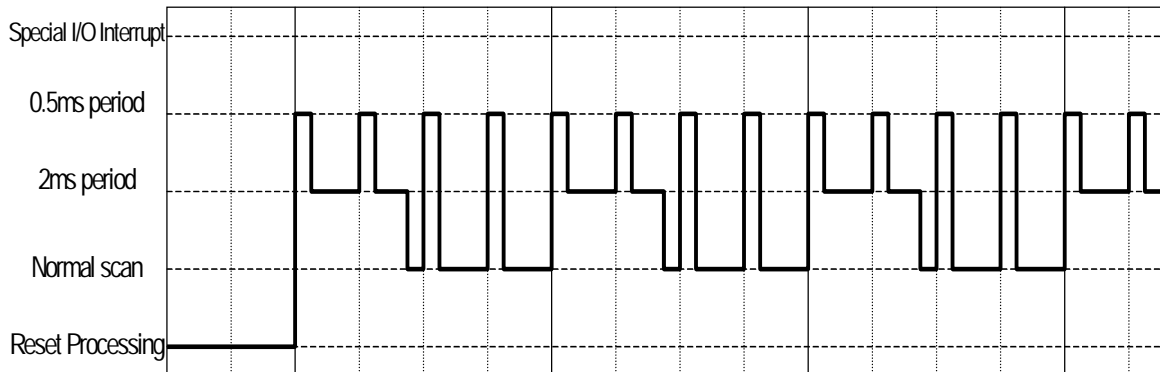

### ◆ Special I/O

If a Special I/O parameter change is performed during normal processing, the 2ms period's processing is changed. When the 2ms period is extended, in order to compress the normal scan time, the normal scan time is also increased.

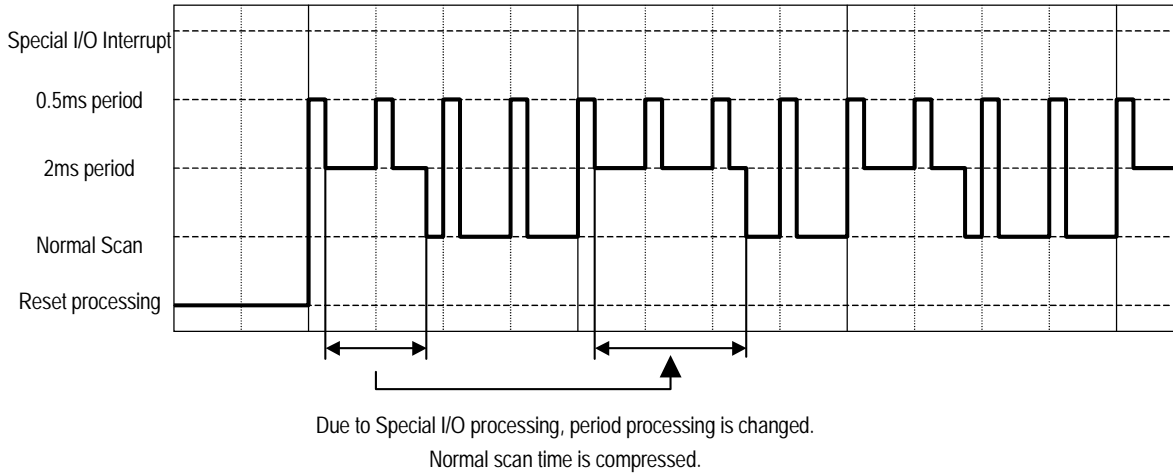

### ◆ When Interrupt Processing Occurs

If a Special I/O interrupt occurs and Special I/O is used, the interrupt processing can be performed at any arbitrary timing. During special I/O interrupt processing, in order to compress all other types of processing times, other processing times are increased.

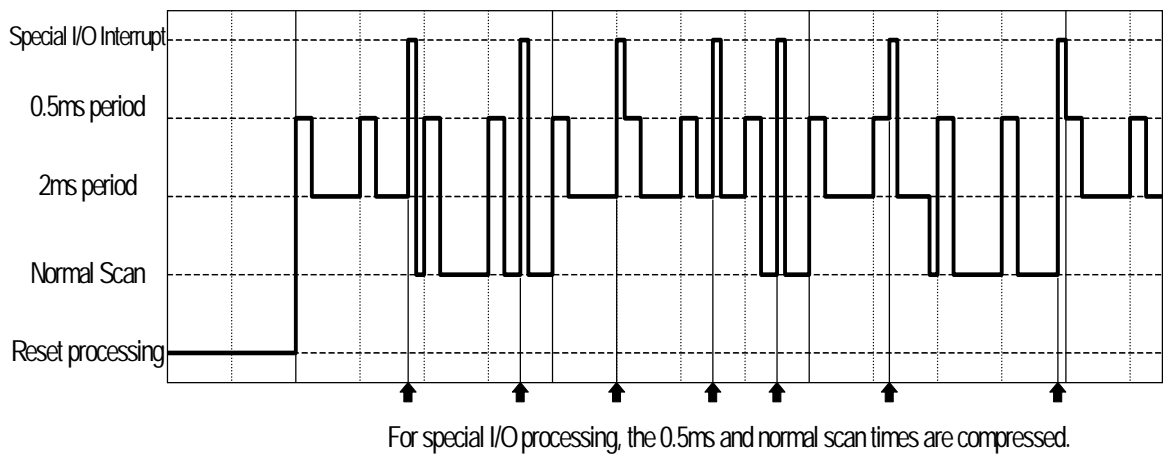

## 2.2 I/O Settings

After creating a logic program, you can enable real I/O control by assigning appropriate variables to actual I/O terminals.

The following sections describe how to assign functions to I/O terminals, including Standard I/O, High-Speed Counter, Pulse Output and PWM Output.

### 2.2.1 Overview

#### ■ Allocating Standard I/O, High-Speed Counter, Pulse Output and PWM Output

Standard I/O, High-Speed Counter, Pulse Output and PWM Output are assigned to the LT unit's DIO32-point interface I/O. Standard I/O can be assigned to any input terminals from X0 to X15 and to any output terminals from Y0 to Y15. The High-Speed Counter, PWM Output and Pulse Output, however, can only be assigned to input terminals X0 to X7 and to output terminals Y0 to Y3, as indicated below.

For details, **Reference** 2.2.2 I/O Allocation (General) ■ Setting Standard I/O, High-Speed Counter, PWM Output and Pulse Output

X15	X14	X13	X12	X11	X10	X9	X8	X7	X6	X5	X4	X3	X2	X1	X0
Y15	Y14	Y13	Y12	Y11	Y10	Y9	Y8	Y7	Y6	Y5	Y4	Y3	Y2	Y1	Y0

Depending on the type of LT unit used, the following I/O point amounts may vary.

	I/O Type	Type H-AD	Type H-ADP	Type H-ADT
Standard Input <sup>*1</sup>	DIO	16	16	16
Standard Output (200mA) <sup>*1</sup>		8	8	8
Standard Output (500mA) <sup>*1</sup>		8	8	8
PWM Output <sup>*1</sup>	Special I/O	4	4	4
Pulse Output <sup>*1</sup>		4	4	4
High-Speed Counter <sup>*1*2</sup>		4	4	4

#### ■ Assigning Analog I/O

The Analog I/O is assigned to the Analog Interface I/O terminals. Analog I/O can be assigned to two terminals - CH1 and CH2.

	I/O type	Type H-AD	Type H-ADP	Type H-ADT
Analog Input	Analog I/O	2	2	2
Analog Output		1	2	2

*\*1 Since the I/O terminals for the Standard Input, Standard Output, PWM Output, Pulse Output and High-Speed Counter I/O are common, it will not be possible to simultaneously use the maximum number of each of these units.*

*\*2 When using 2-phase Counters, the maximum number of counters that can be used is one 2-phase Counter and two Single-phase Counters.*

### ■ Assigning Thermocouple Input and Pt100 Input

The Thermocouple Input and Pt100 Input are assigned to the I/O terminals for "Temperature Input Interface." The Thermocouple Input can be assigned to three terminals for CH1, CH2 and CH3, and the Pt100 Input can be assigned to two terminals for CH1 and CH2.

	I/O Type	Type H-AD	Type H-ADP	Type H-ADT
Thermocouple Input	Temperature Input	-	-	3
Pt100 Input		-	2	-

### 2.2.2 I/O Allocation (General)

Use the LT Editor [Configure I/O] dialog box to assign I/O terminals for the DIO32-point Interface, Analog I/O Interface and Temperature I/O Interface.

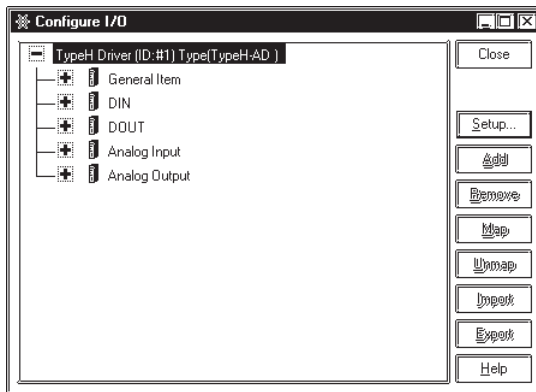

### ■ General Settings

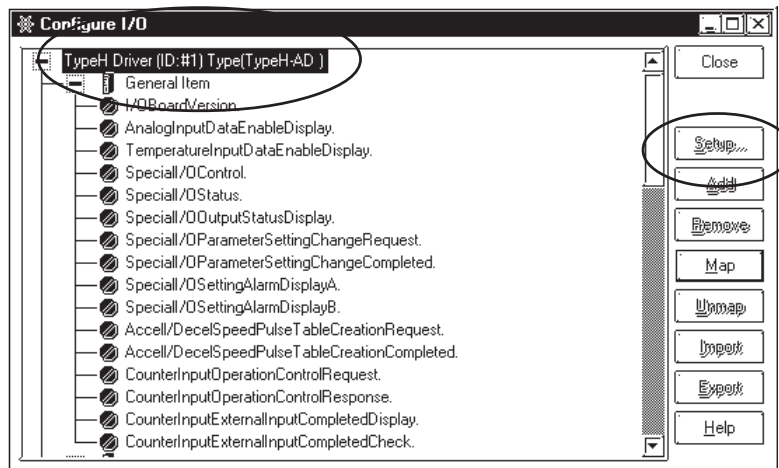

In the [General Item Setup] dialog box, select the LT type and the unit for temperature input, and specify whether a 2-phase counter is to be used.

▼ **Reference** ▲ 2.2.5 High-Speed Counter (General Settings)

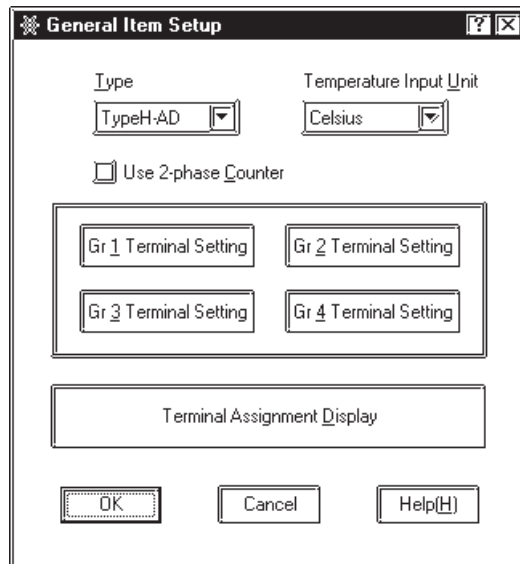

The above dialog box's [Group\*Terminal Settings(\*)] and [Terminal Assignment Display] items are explained in the ■ DIO, High-Speed Counter, PWM Output, Pulse Output Settings.

## ■ DIO, High-Speed Counter, PWM Output, Pulse Output Settings

### ◆ Overview

This sections explains the allocation methods used for the Input terminals X0 to X7, and Output terminals Y0 to Y3. As shown in the figure below, in the LT Editor software these terminals are arranged into 4 groups, which are then allocated according to the [Setting Pattern [P]] shown on the following page.

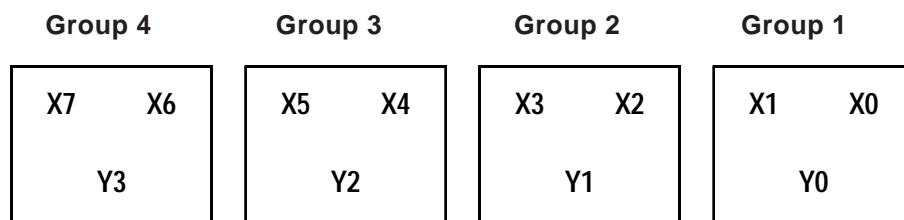

These groups are listed in the [General Item Setup] dialog box.

Input terminals X0 and X1, and Output terminal Y0, are combined in “Group 1”.  
 Input terminals X2 and X3, and Output terminal Y1, are combined in “Group 2”.  
 Input terminals X4 and X5, and Output terminal Y2, are combined in “Group 3”.  
 Input terminals X6 and X7, and Output terminal Y3, are combined in “Group 4”.



## Chapter 2 – I/O Settings

For example, clicking on the [Group 1] setting will call up the following dialog box. Selecting [Pattern 5] will designate the I/O settings as: X0: Counter Input, X1: DIN, and Y0: Synch. Output. (When not using a 2-phase Counter.)

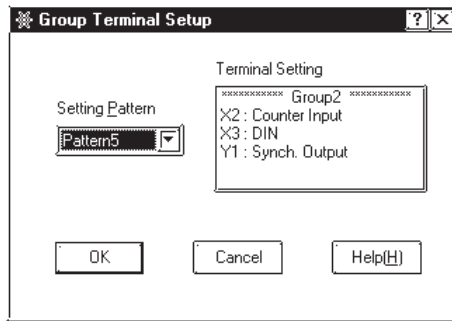

After all groups are allocated, the [Terminal Assignment Display] can be used to check the terminal allocations. The following screen shows the results of the following allocations. (When not using the 2-phase Counter)

- [Group 1]     used Pattern 5
- [Group 2]     used Pattern 2
- [Group 3]     used Pattern 4
- [Group 4]     used Pattern 3

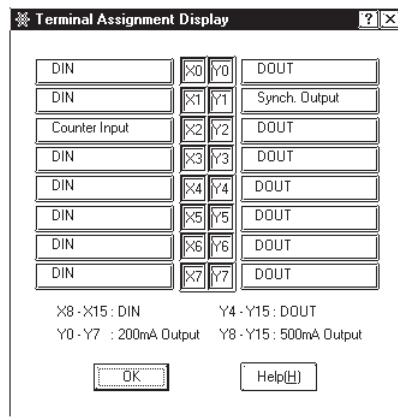

### ◆ [Setting Pattern] List (when NOT using the 2-phase Counter)

No.	X(2n-2)	X(2n-1)	Y(n-1)
1	DIN	DIN	DIN
2			PWM Output
3			Pulse Output
4	Counter Input	DIN	DIN
5			Synch. Output
6		Preload Input	DOUT
7			Synch. Output
8			DOUT
9	Pre-strobe Input	Synch. Output	

n : group number

◆ When using 2-phase Counter - [Gr1 Terminal Setting]

No.	X0	X1	Y0
1	Counter Input 1A	DIN	DOUT
2			Synch. Output
3		Preload Input	DOUT
4			Synch. Output
5		Pre-strobe Input	DOUT
6			Synch. Output

◆ When using 2-phase Counter - [Gr2 Terminal Settings]

No.	X2	X3	Y1
1	Counter Input 1B	Counter Input 1Z (Marker Input)	DOUT
2			PWM Output
3			Pulse Output
4		DIN	DOUT
5			PWM Output
6			Pulse Output

◆ When using 2-phase Counter - [Gr3 Terminal and Gr4 Terminal Settings]

These settings are same as when not using the 2-Phase Counter.

■ LT Type H-AD Setup

1. Open the Project Manager and select the LT unit type - “LT Type H”.

2. Enter the [TypeH Driver [ID:#1] Type[TypeH-AD]] settings in the [Configure I/O] screen.

- I/O type
- Temperature Input units
- Use/not use 2-phase Counter
- Group Terminal Settings

3. Allocate the Driver’s General Item variable(s).

- I/O Board Version
- AnalogInputDataEnableDisplay

\* I/O Type settings will vary depending on the [Group Terminal setting] used. For details, refer to next page’s [General Item Setup] list.

4. Perform individual I/O mode settings.

Standard Input

- Digital Input Filter Time

Standard Output

- Controller Stop Output Status

Analog Input

- Analog Input Range
- Analog Input Filter Time

Analog Output

- Analog Output Range
- Output Status at Controller Stop

\* I/O Type settings will vary depending on the [Group Terminal settings] used. For details, refer to next page's [General Item Setup] list.

### 5. Allocate variables for special I/O parameter items.

\* I/O Type settings will vary depending on the [Group Terminal settings] used. For details, refer to next page's [General Item Setup] list.

6. Allocate variables for terminals.

- DIO terminals (any setting)
- Analog I/O terminals (any setting)

7. Use the Error Check feature to check the data/settings.

### ■ General Item Setup

When using the LT Type H unit, be sure to enter these settings first.

Setting Item	Description
Type (I/O type)	Select the I/O type.
Temperature Input Unit	Select the units used for temperature input data display.
Use 2-Phase Counter	Selects the 2-phase Counter feature.
Group Terminal Settings	Designates the DIO terminal settings.

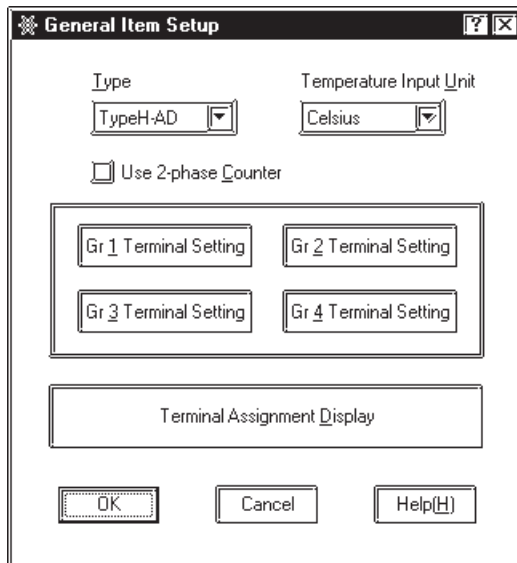

■ **General Settings**

Allocate all variables used for each I/O. Allocated variables must be integers only. Also, usable range is only the lower 16 bits. Depending on the I/O used, the settings available will change.

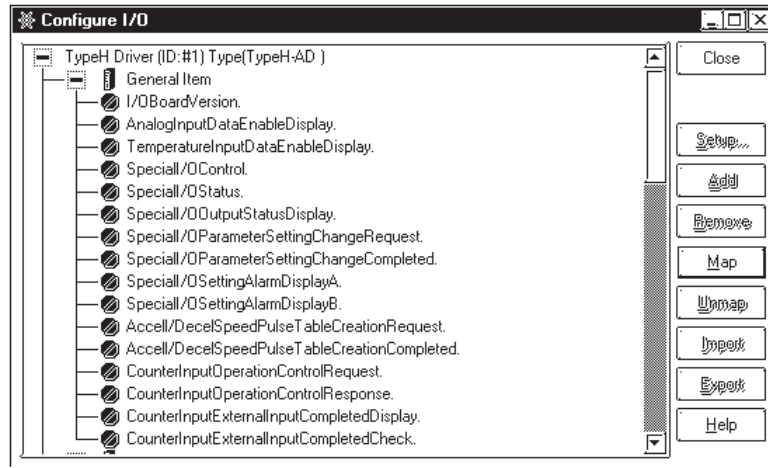

Terminal Name	Normal	Temp Input	High Speed Counter	PWM Output	Pulse Output
I/O Board Version	○				
Analog Input Data Enable Display	○				
Temperature Input Data Enable Display		○			
Special I/O Control			○	○	○
Special I/O Status			○	○	○
Special I/O Output Status Display			○	○	○
Special I/O Parameter Setting Change Request			○	○	○
Special I/O Parameter Setting Change Completed			○	○	○
Special I/O Parameter Setting Alarm Display A				○	○
Special I/O Parameter Setting Alarm Display B			○		○
Accel/Decel Speed Pulse Table Creation Request					○
Accel/Decel Speed Pulse Table Creation Completed					○
Counter Input Operation Control Request			○		
Counter Input Operation Control Response			○		
Counter Input External Input Completed Display			○		
Counter Input External Input Completed Check			○		

\* “○” indicates that this item must be set.



### ◆ Special I/O Control

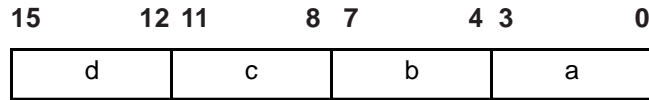

Special I/O Control is set using 4 bits of data, which designates the Group used.

a: Group 1 Special I/O Control    c: Group 3 Special I/O Control

b: Group 2 Special I/O Control    d: Group 4 Special I/O Control

PWM Output

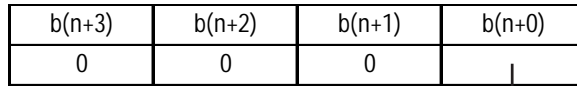

└─ PWM Output Control 0: Stop/1: Start

Pulse Output

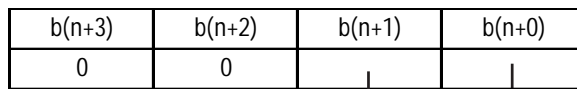

└─ Pulse Output Control 0: Stop/1: Start

└─ Accel/Decel Speed Pulse setting 0: Disable/1: Enable

High-Speed Counter (including 2-phase Counter)

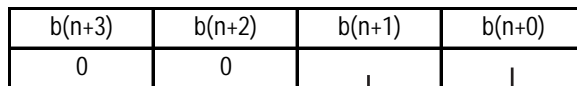

└─ High-Speed Counter Control 0: Stop/1: Start

└─ Synch. Output setting 0: Disable/1: Enable

The “n” character shown in the bit number, depending on the group number, will become 0, 4, 8, 12.

### ◆ Special I/O Status

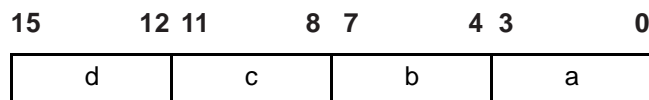

Special I/O Status is set using 4 bits of data, which designates the Group used.

a: Group 1 Special I/O Status    c: Group 3 Special I/O Status

b: Group 2 Special I/O Status    d: Group 4 Special I/O Status

PWM Output

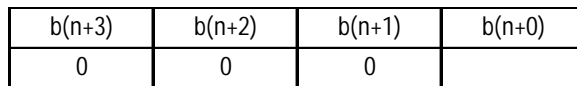

└─ PWM Output Status 0: Stop/1: Start

Pulse Output

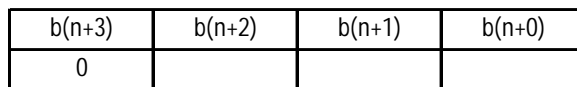

└─ Pulse Output Status 0: Stop/1: Start

└─ Accel/Decel Speed Pulse setting 0: Disable/1: Enable

└─ Accel/Decel Speed Pulse Amount Output Completed

0: not completed/ 1: Completed

## Chapter 2 – I/O Settings

### High-Speed Counter (including 2-phase Counter)

b(n+3)	b(n+2)	b(n+1)	b(n+0)
0	0		

High-Speed Counter Status 0: Stopped/1: Started  
 Synch. Output Setting Status 0: Disable/1: Enable

The “n” character shown in the bit number, depending on the group number, will become 0, 4, 8, 12.

### ◆ Special I/O Output Status Display

15	12 11	8 7	4 3	0
d	c	b	a	

Special I/O Output Status Display is set using 4 bits of data, which designates the Group used.

a: Group 1 Special I/O Output Status    c: Group 3 Special I/O Output Status  
 b: Group 2 Special I/O Output Status    d: Group 4 Special I/O Output Status

b(n+3)	b(n+2)	b(n+1)	b(n+0)
0	0	0	

Special I/O Output Status 0: Stop/1: Start

The “n” character shown in the bit number, depending on the group number, will become 0, 4, 8, 12.

### ◆ Special I/O Parameter Setting Change Request

15	12 11	8 7	4 3	0
d	c	b	a	

Special I/O Parameter Setting Change Request is set using 4 bits of data, which designates the Group used.

a: Group 1 Special I/O Parameter Setting Change Request  
 b: Group 2 Special I/O Parameter Setting Change Request  
 c: Group 3 Special I/O Parameter Setting Change Request  
 d: Group 4 Special I/O Parameter Setting Change Request

b(n+3)	b(n+2)	b(n+1)	b(n+0)
0	0		

Special I/O Parameter Setting Change Request  
 0: No request/1: Request  
 Special I/O Parameter Setting Read Request  
 0: No request/1: Request

- \* Be sure to perform all parameter changes prior to turning the Special I/O Parameter Setting Request bit ON.
- \* It is not possible here to change Accel/Decel Speed Pulse parameters. This should be performed using the Accel/Decel Speed Pulse table Creation Request Flag.
- \* When reading out the Accel/Decel Speed Pulse Parameters, be sure to also turn the Special I/O Control's Accel/Decel Speed Pulse Output Control Flag ON at the same time.
- \* The “n” character shown in the bit number, depending on the group number, will become 0, 4, 8, 12.

### ◆ Special I/O Parameter Setting Change Completed

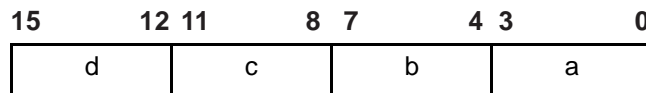

Special I/O Parameter Setting Change Completion is set using 4 bits of data, which designates the Group used.

- a: Group 1 Special I/O Parameter Setting Change Completed
- b: Group 2 Special I/O Parameter Setting Change Completed
- c: Group 3 Special I/O Parameter Setting Change Completed
- d: Group 4 Special I/O Parameter Setting Change Completed

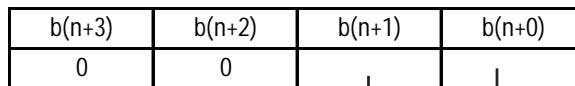

└─ Special I/O Parameter Setting Change Completed  
 0: No request/1: Request  
  
 └─ Special I/O Parameter Setting Read Completed  
 0: No request/1: Request

- \* The “n” character shown in the bit number, depending on the group number, will become 0, 4, 8, 12.



### ◆ Special Parameter Setting Alarm Display A

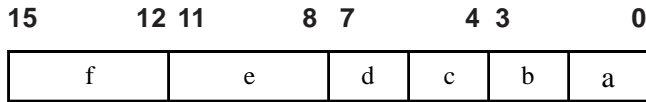

- a: Group 1 Special PWM Output Parameter Alarm
- b: Group 2 Special PWM Output Parameter Alarm
- c: Group 3 Special PWM Output Parameter Alarm
- d: Group 4 Special PWM Output Parameter Alarm
- e: Groups 1 to 4 Pulse Output Frequency Alarm
- f: Pulse Output Frequency Total Alarm

#### PWM Output Parameter Alarm

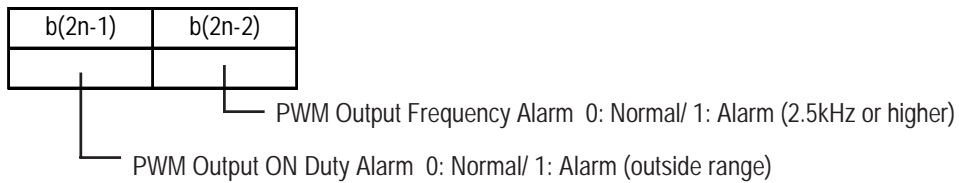

\* The “n” character shown in the bit number is the Group number.

#### Pulse Output Frequency Alarm

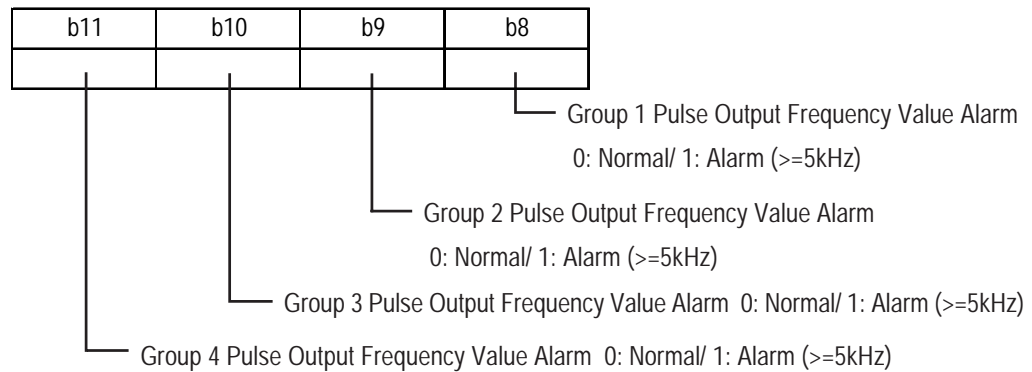

#### Pulse Output Frequency Total Alarm

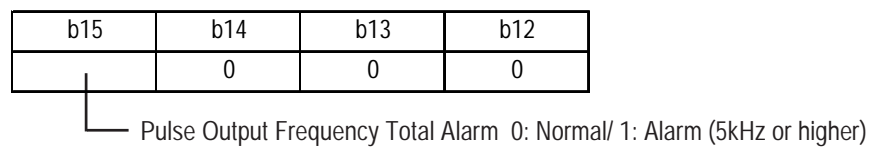

- \* The “n” character shown in the bit number is the Group number.
- \* If the parameter being changed via the Special I/O Parameter change has an Alarm, the related bit will turn ON.

◆ Special Parameter Setting Alarm Display B

15	12 11	8 7	4 3	0
Not used	c	b	a	

- a: Groups 1 to 4 Counter Preset Value Alarm
- b: Groups 1 to 4 Pulse Initial Output Frequency Value Alarm
- c: Groups 1 to 4 Accel/Decel Speed Pulse Parameter Warning

**Counter Preset Value Alarm**

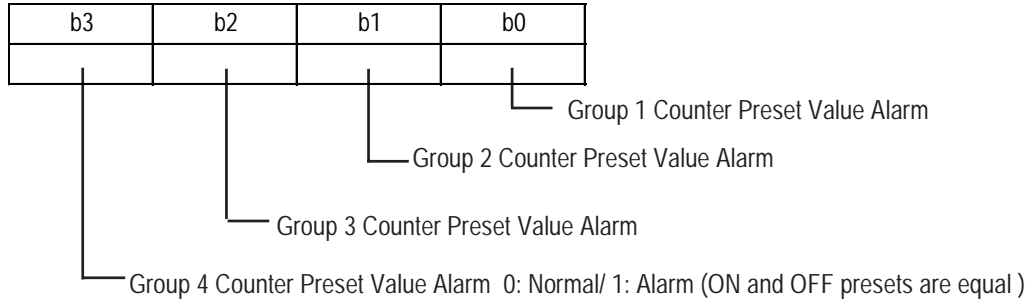

**Pulse Initial Output Frequency Value Alarm**

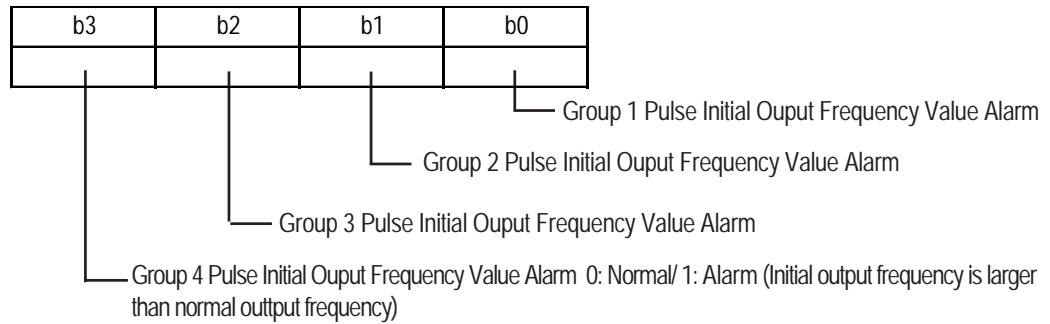

**Accel/Decel Speed Pulse Parameter Warning**

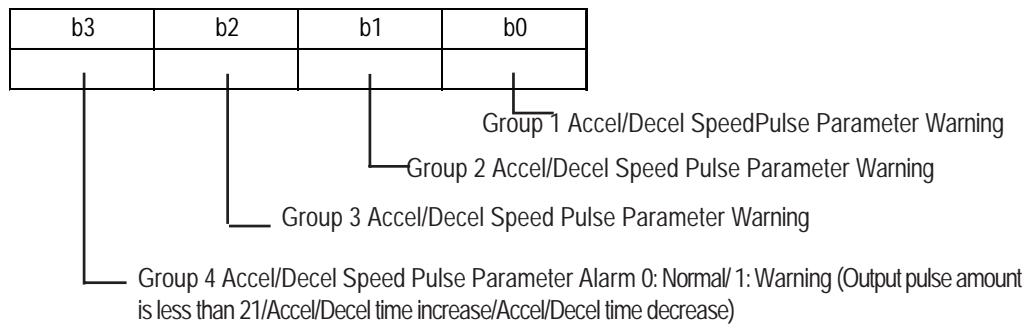

### ◆ Accel/Decel Speed Pulse Table Creation Request

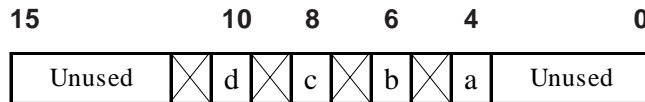

a: Group 1 Accel/Decel Speed Pulse Table Creation Request 0: No request/ 1: Request

b: Group 2 Accel/Decel Speed Pulse Table Creation Request 0: No request/ 1: Request

c: Group 3 Accel/Decel Speed Pulse Table Creation Request 0: No request/ 1: Request

d: Group 4 Accel/Decel Speed Pulse Table Creation Request 0: No request/ 1: Request

### ◆ Accel/Decel Pulse Table Creation Completed

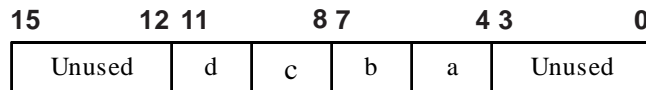

a: Group 1 Accel/Decel Pulse Table Creation Completed

b: Group 2 Accel/Decel Pulse Table Creation Completed

c: Group 3 Accel/Decel Pulse Table Creation Completed

d: Group 4 Accel/Decel Pulse Table Creation Completed

### Accel/Decel Pulse Table Creation Completed

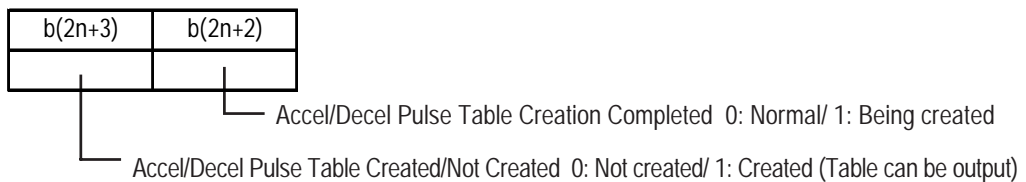

\* The “n” character shown in the bit number is the Group number.

◆ Counter Input Operation Control Request

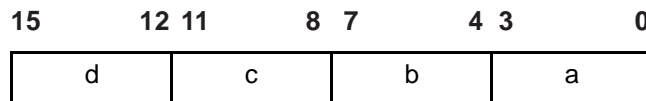

Counter Input Operation Control Request is set using 4 bits of data, which designates the Group used.

- a: Group 1 Counter Input Operation Control Request
- b: Group 2 Counter Input Operation Control Request
- c: Group 3 Counter Input Operation Control Request
- d: Group 4 Counter Input Operation Control Request

Counter Input Operation Control Request

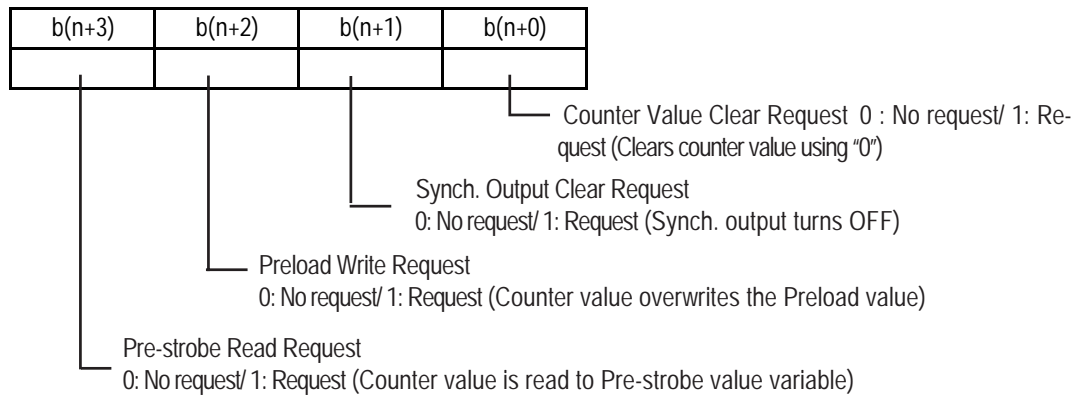

\* The "n" character shown in the bit number, depending on the group number, is 0, 4, 8, 12.

◆ Counter Input Operation Control Response

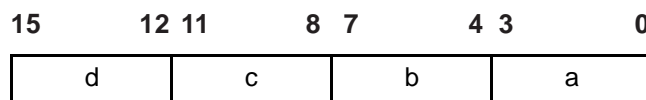

Counter Input Operation Control Response is set using 4 bits of data, which designates the Group used.

- a: Group 1 Counter Input Operation Control Response
- b: Group 2 Counter Input Operation Control Response
- c: Group 3 Counter Input Operation Control Response
- d: Group 4 Counter Input Operation Control Response

### Counter Input Operation Control Response

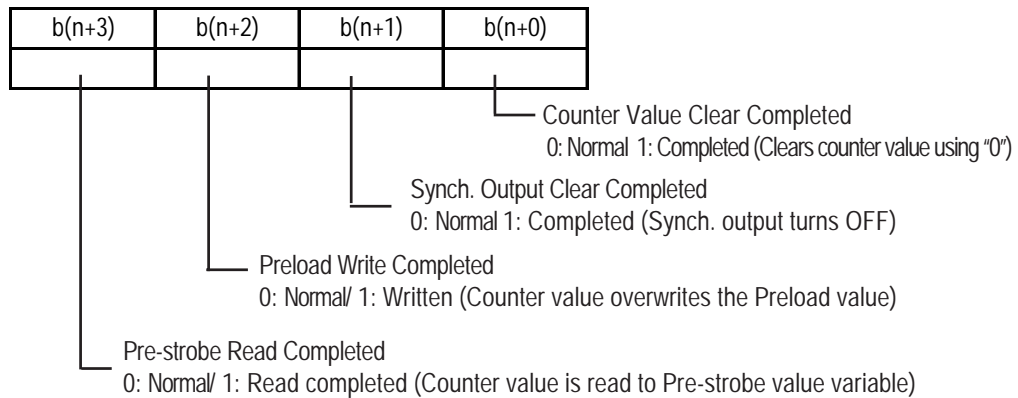

\* The "n" character shown in the bit number, depending on the group number, is 0, 4, 8, 12.

#### ◆ Counter Input External Input Completed Display

Announces that the Counter Special External Input (Preload/ Prestrobe Input/ Marker Input (\*1)) has turned ON and that the new counter value Write or Read out, has been completed.

15	12 11	8 7	4 3	1 0				
Not used	e	Not used	d	Not used	c	Not used	b	a

a: Group 1 Preload/Pre-strobe is completed 0: Normal 1: Completed

b: 2-phase Counter Input's Marker Input (\*1) is completed 0: Normal 1: Completed

c: Group 2 Preload/Pre-strobe is completed 0: Normal 1: Completed

d: Group 3 Preload/Pre-strobe is completed 0: Normal 1: Completed

e: Group 4 Preload/Pre-strobe is completed 0: Normal 1: Completed

#### ◆ Counter Input External Input Completed Check

Used to check the Counter Special External Input (Preload/ Prestrobe Input/ Marker Input (\*1)) has been completed.

15	12 11	8 7	4 3	1 0				
Not used	e	Not used	d	Not used	c	Not used	b	a

a: Group 1 Preload/Pre-strobe Completion Check 0: Normal 1: Check completed

b: 2-phase Counter Input's Marker Input (\*1) Completion Check 0: Normal 1: Completed

c: Group 2 Preload/Pre-strobe Completion Check 0: Normal 1: Check completed

d: Group 3 Preload/Pre-strobe Completion Check 0: Normal 1: Check completed

e: Group 4 Preload/Pre-strobe Completion Check 0: Normal 1: Check completed

\*1 Indicates the use of 2-phase counter input

### ■ I/O Mode Settings

The LT Type H unit's I/O has a variety of features. For details, refer to each I/O feature's separate explanation.

Item	Setting Data	Default	Setting Range
General Items	Type	Type H-AD	Type H-AD/ADT/ADP
	Temperature Input Unit	Centigrade	Fahrenheit/Centigrade
	2-phase Counter (Used/Not used)	Not Used	Used/Not used
Group Terminal Settings	Terminal Setting Pattern	DIO	Patterns 1 to 9
Standard Input Settings	Digital Input Filter Time	0	0 to 40 (0.5 to 20ms)
Standard Output Settings	Hold output values after Controller stop	Not held	Held/ Not held
Analog Input Settings	Analog Input Range	0 to 10V	0 to 10V/0 to 20mA/4 to 20mA
	Analog Input Filter Frequency	0	0 to 64 times
Analog Output Settings	Analog Output Range	0 to 10V	0 to 10V/0 to 20mA
	Hold output values after Controller stop	Not held	Held/ Not held
Thermocouple Input Settings	Thermocouple Input Range	J	J/K
	Thermocouple Input Filter Samp.	0	0 to 64 times
Pt100 Input Settings	Pt100 Input Filter Samp.	0	0 to 64 times
High-Speed Counter Settings	Hold Counter value after Controller stop	Not held	Held/ Not held
(Single-phase Counter)	Hold Synch. Output values after Controller stop	Not held	Held/ Not held
High Speed Counter Settings	2-phase Counter mode	Mode 0	Modes 0 to 4
(2-phase Counter)	Hold Counter value after Controller stop	Not held	Held/ Not held
	Hold Synch. Output values after Controller stop	Not held	Held/ Not held

### ■ Special I/O Parameter Settings

Depending on the type of special I/O used, Special I/O Parameter Settings may need to be set. The setting items available for each feature will vary.

Special I/O Types	Parameters	Effective Range
PWM Output	Output Frequency	10Hz to 2.5kHz
	OnDuty	0 to 100%
Pulse Output	Output Frequency	10Hz to 5kHz
	Output Pulse Count	0 to 65,535
	Initial Output Frequency	0, 10 to 5000Hz
	Accel/Decel Speed Time	0 to 65,535ms
	Pulse Output Count Current Value	0 to 65,535
High-Speed Counter	Count Content Type Change	0 to 3
	Preload Value	0 to 65,535
	Pre-strobe Value	0 to 65,535
	On Preset value	0 to 65,535
	Off Preset value	0 to 65,535
	Counter Current Value	0 to 65,535



**Since updating pulse output's current value is performed during the I/O board's normal processing cycle, a 2ms processing cycle will require a maximum of "40ms + LT Scan time".**

### 2.2.3 DIN

---

The I/O board's microcomputer monitors the Input terminals' status every 0.5ms, and the I/O refresh performed every 2ms writes the input status to I/F RAM.

If you choose to use a digital input filter time, the I/O refresh timing is used as a trigger to write the average of the collected (sampled) input values to I/F RAM. The number of samples is set using the Sampling Frequency setting. This averaged value is then read out each scan time.

#### ■ Digital Input Filter Time

This filter is designed to remove/reduce signal noise via software. This filter can be set in 0.5ms units, starting at 0.5ms and going to 20ms.

When this filter is used, data that is sampled every 0.5ms is stored internally. Then, the data is read out when the I/O refresh is performed every 2ms, while referring back to the previously read input terminal status data.

When all the input terminal status is the same, that value is used as the input terminal value. If the values do not agree within the designated period of time, the previous value is used. (The digital input filter's timing setting is used to check if the amount of sampling data satisfies or does not satisfy the filter's time setting. If it does not, the input status becomes OFF.)

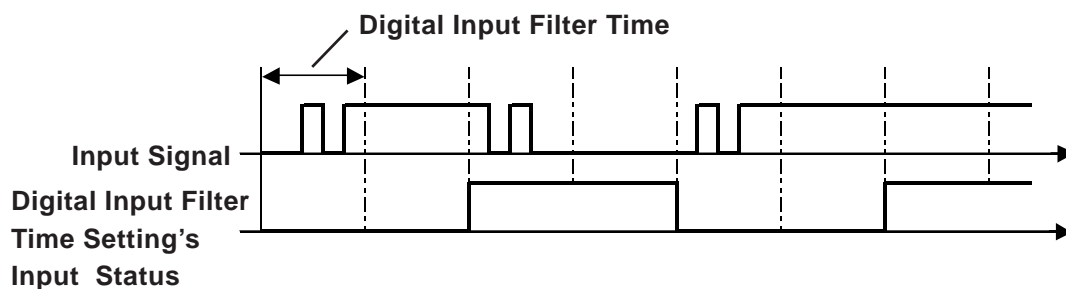

- **Be sure to consider the output characteristics of your connected device(s) and also any possible noise when setting up this feature's filter time.**
- **Depending on the Group terminal settings used and if the special I/O is used, input terminals in the same group cannot be used for DIN.**

■ **DIN Setup**

1. Double-click on the [Configure I/O] dialog box's [DIN] setting, or click once on the [DIN] and click on the [Setup] button. (see image)

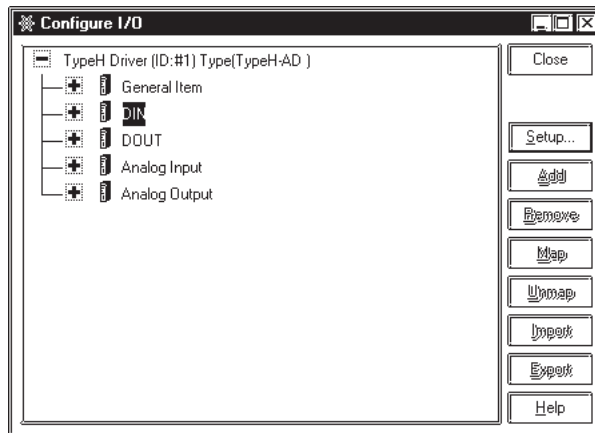

Depending on the Group terminal settings used and if the special I/O is used, input terminals in the same group are not displayed.

2. When the [DIN Setup] dialog box appears, enter the desired DIN filter time in 0.5ms units.

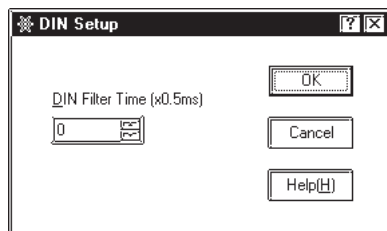

- This filter can be set from 0 to 20ms.
- A setting value of “0” ms means the digital input filter is not used.



### 2.2.4 DOUT

When using the Type H driver, output data is written to I/F RAM every scan time, and the I/O board then reads the I/F RAM's output area every 2ms. The data read out is reflected to the I/O board's output terminals.

The normal output terminals Y0 to Y7 provide 200mA output and Y8 to Y15 provide 500mA output. DOUT is also used to designate whether output hold is used or not used during controller stop periods.

#### ■ Output Hold At Controller Stop

This feature will hold the current output condition when the logic program stops. Then, when the logic program restarts, the hold is released and operation starts again. However, if the variables allocated are non-hold types, these variables are all turned OFF. Also, when the unit is changed to OFFLINE mode or is reset, or main power is turned OFF, all held variables are reset to OFF in order to reset all I/O to its initial state.



- The output hold setting applies to ALL terminals.
- Depending on the Group terminal settings used and if the special I/O is used, input terminals in the same group cannot be used for Standard Input.

#### ■ DOUT Setup

1. Double-click on the [Configure I/O] dialog box's [DOUT] setting, or, click once on the [DOUT] setting and then click on the [Setup] button. (see image)

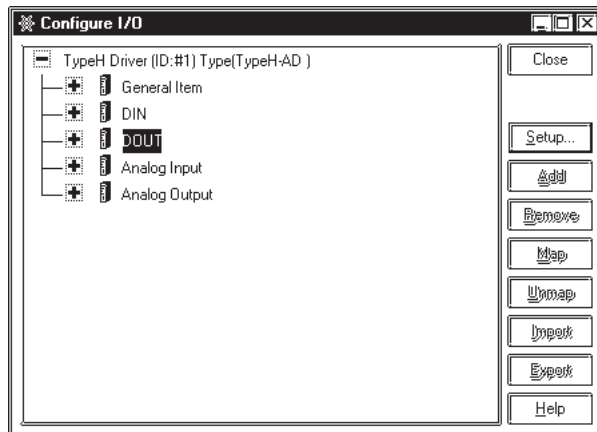

- Depending on the Group terminal settings used and if the special I/O is used, input terminals in the same group are not displayed.

2. The [DOUT Setup] dialog box appears. Hold is set by clicking on the checkbox and clicking on [OK].

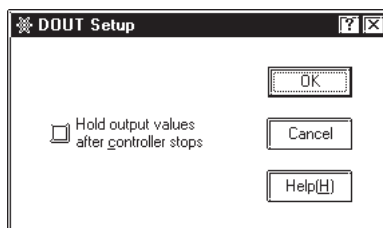

### 2.2.5 High-Speed Counter (General Use)

The High-Speed Counter can count pulse signals of up to 10 kHz from 0 to 65535 (16 bits). Two types of High-Speed Counters are provided: a Single-phase Counter that occupies one input terminal; and a 2-phase Counter that occupies two input terminals. The available functions and the terminal numbers to be assigned vary depending on the type. For details about single and two-phase counters,

**Reference** 2.2.6 *High-Speed Counter (Single-phase Settings)*,  
2.2.7 *High-Speed Counter (2-phase Counter Settings)*

#### ■ Feature Overview

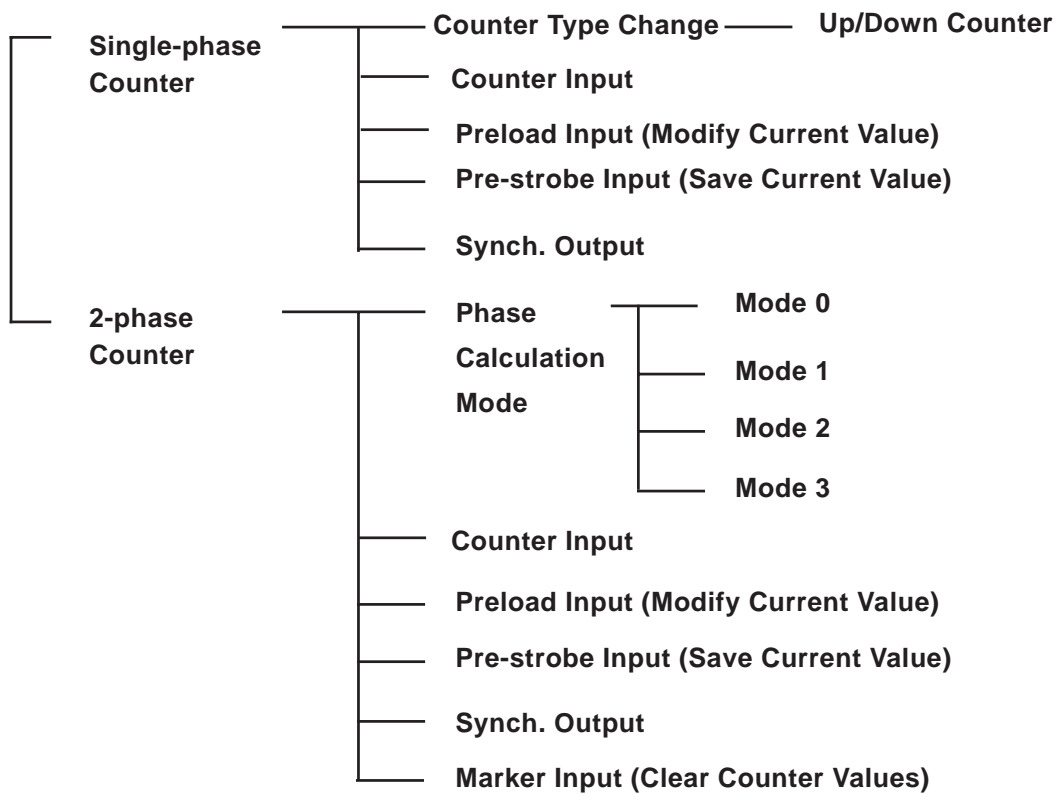

#### ■ Terminal Number Allocations

Feature	Single Phase	2-Phase	Usable Terminal Numbers
Counter Input	0	0	Single-phase: X0,X2,X4,X6
			2-phase: X0,X2
Preload Input	0	0	Single-phase: X1,X3,X5,X7
			2-phase: X1,X5,X7
Pre-strobe Input	0	0	Single-phase: X1,X3,X5,X7
			2-phase: X1,X5,X7
Synch. Output	0	0	Single-phase: Y0,Y1,Y2,Y3
			2-phase: Y0,Y2,Y3



**Note:** To set the usable terminal numbers, use the [General Item Setup | Group Terminal Setup] area. **Reference** 2.2.2 *I/O Allocation (General)*

### ■ Counter Value and Synch. Output at Controller Stop

When the logic program stops, the current value data in all counters is held. When the logic program is restarted, operation starts from the retained value. Also, when the LT unit is changed to OFFLINE mode or is reset, or the main power is turned OFF, all counter values are reset in order to initialize all I/O.

### ■ High-Speed Counter Setup

1. Double-click on the [Configure I/O] dialog box's [High-Speed Counter [Group1]] setting, or, click once on the [High-Speed Counter [Group1]] setting and then click on the [Setup] button. (see image)

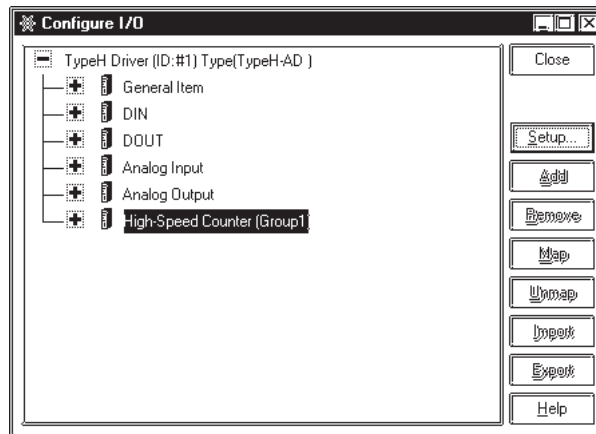

2. The [High-Speed Counter Setup] dialog box appears. Counter Value and/or Synch. Output Hold is set by clicking on the checkbox and clicking on [OK].

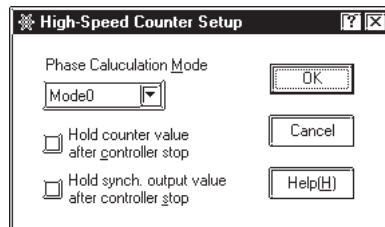

## 2.2.6 High-Speed Counter (Single-phase Setting)

The Single-phase Counter is a counter that occupies one input terminal to measure Single-phase Input signals.

### ■ Changing Up/Down Counting

During counting, the counting method can be switched between the up counter and down counter. Also, the counting method can be changed for the particular group to which the counter is assigned.



When changing the count method, a single pulse may be skipped.

### ◆ Summary

The following steps are used to change the up/down counting method.

1. Set the count method and the counting edge with [Counting Method Change].
2. Set the parameters with [Special I/O Parameter Setting Change Request].
3. Check the changes in [Special I/O Parameter Setting Change Completed].
4. Use [Special I/O Control] to start counting.
5. Confirm the operation with [Special I/O Status].



As mentioned earlier, the actions performed by [Special I/O Parameter Setting Change Request] and [Special I/O Parameter Setting Change Completed] are reflected in all the parameters in a group.

### ■ Count Method Setup

1. Allocate variable(s) to the [Configure I/O] dialog box's [High-Speed Counter]'s [CounterTypeChange] item. (see image)

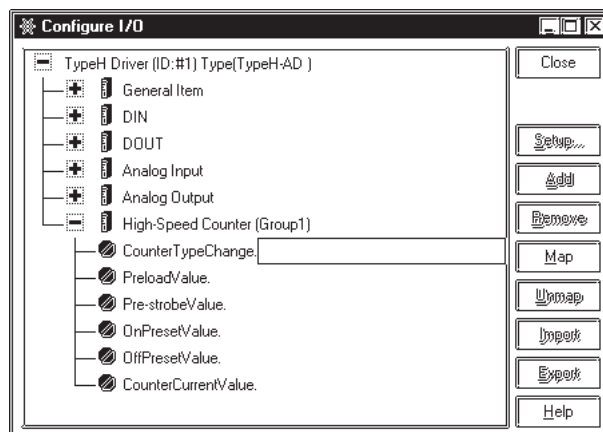

2. The [CounterTypeChange] detailed settings should be like the drawing below, i.e. when the “0” bit position’s bit is set to OFF, counting is UP, and when it is set to ON, counting is DOWN. Also, when the “1” bit position is set to OFF (0), the count trigger is the rising edge, and ON (1) is the falling edge.

15

1 0

Not used	b	a
----------	---	---

- a: Count Type [0]:Count Up, [1]:Count Down  
 b: Count Edge [0]:Rising Edge, [1]:Falling Edge

3. Allocate variables to the [General Item]’s [Special I/O Parameter Setting Change Request] and [Special I/O Parameter Setting Change Completed] items. (see image)

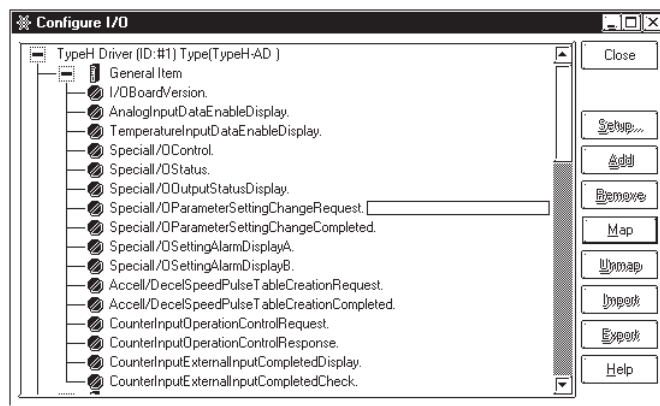

4. The [Special I/O Parameter Setting Change Request] detailed settings should be like the drawing below, i.e. showing to which group counters are allocated. The bits used will change, depending on how this allocation is set.

15

13

12

9

8

5

4

1

0

Not used	h	g	Not used	f	e	Not used	d	c	Not used	b	a
----------	---	---	----------	---	---	----------	---	---	----------	---	---

- a: Group 1 Special I/O Parameter Setting Change Request  
 c: Group 2 Special I/O Parameter Setting Change Request  
 e: Group 3 Special I/O Parameter Setting Change Request  
 g: Group 4 Special I/O Parameter Setting Change Request

The readout of the operation bit for the previously set values is as follows.

- b: Group 1 Special I/O Parameter Setting Read Request  
 d: Group 2 Special I/O Parameter Setting Read Request  
 f: Group 3 Special I/O Parameter Setting Read Request  
 h: Group 4 Special I/O Parameter Setting Read Request

5. The following shows the details of the variable assigned to [SpecialI/OParameterSettingChangeCompleted]. The monitoring bits vary depending on the group to which the counter output is assigned.

- a: Group 1 Special I/O Parameter Setting Change Completed
- c: Group 2 Special I/O Parameter Setting Change Completed
- e: Group 3 Special I/O Parameter Setting Change Completed
- g: Group 4 Special I/O Parameter Setting Change Completed

The readout of the monitor bit for the previously set values is as follows.

- b: Group 1 Special I/O Parameter Setting Read Completed
- d: Group 2 Special I/O Parameter Setting Read Completed
- f: Group 3 Special I/O Parameter Setting Read Completed
- h: Group 4 Special I/O Parameter Setting Read Completed

6. The timing of the Special I/O Parameter Setting Change Request and the Completed flag is shown in the following chart.

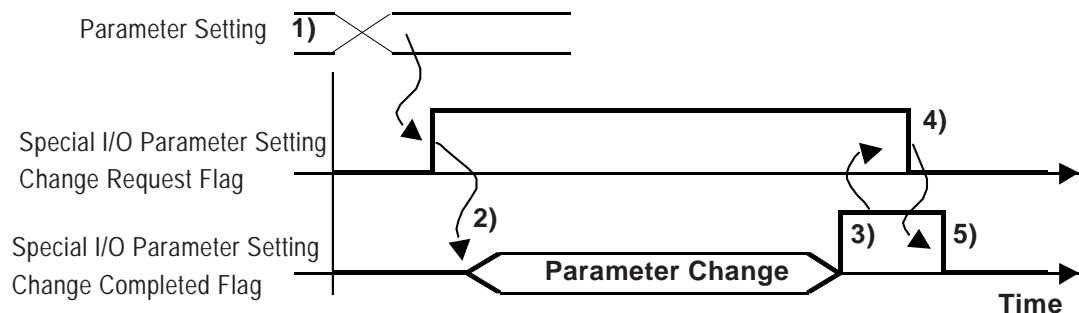

1. Enter all count and count edge settings.
2. When the Special I/O Parameter Setting Change Request flag turns ON, the parameter is changed.
3. After the parameter is changed, the completed flag is turned ON.
4. After confirming that the completion flag has turned ON, turn OFF the request flag.
5. The completion flag turns OFF after it is recognized that the request flag is turned OFF.

### ◆ Up/Down Count Control

This feature starts or stops Up/Down counting. As mentioned previously, after parameters are set, [General Item | SpecialI/OControl] is used to start, or stop, the counter.

#### Setting Procedure

1) Allocate a variable to the [Configure I/O] area's [General Item | SpecialI/OControl] selection.

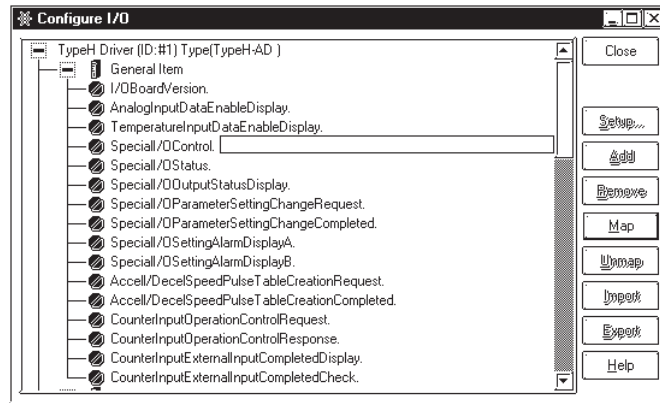

2) As shown below, depending on which group the variable in the [Special I/O Control] selection is allocated to, the bit used will differ.

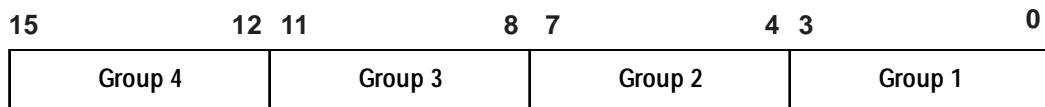

Turning the top bit (0 bit) in a group ON will start the feature, and OFF will stop it.



[1]: Operating, [0]: Stopped

### ◆ Up/Down Count Status

This feature displays the status of the Up/Down counting.

#### Setting Procedure

1) Allocate a variable to the [Configure I/O] area's [General Item | SpecialI/OStatus] selection.

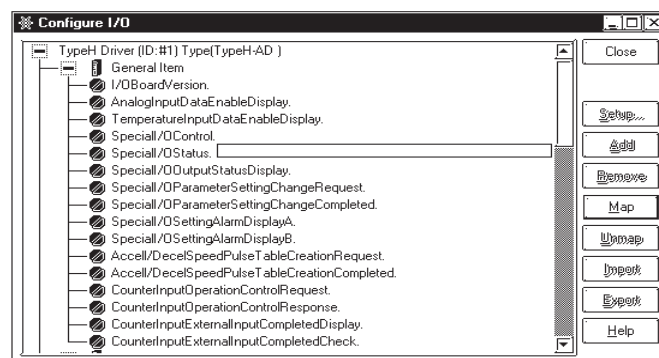





## Chapter 2 – I/O Settings

- 3) As shown below, depending on which group the variable in the [General Item | Counter Input Operation Control Response] selection is allocated to, the monitoring bit used will differ.

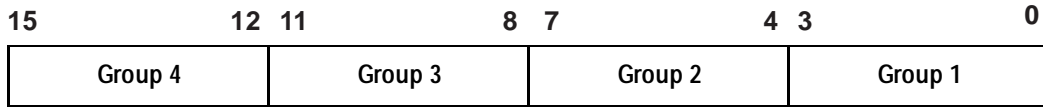

Turning the top bit (0 bit) in a group ON will complete the counter clear.

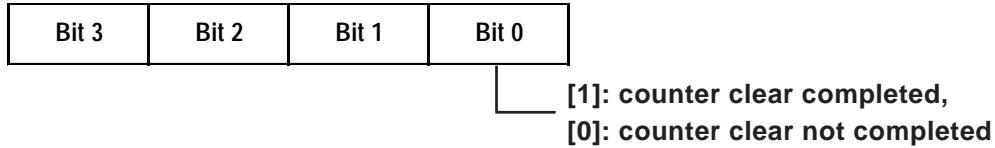

1. The counter value is cleared when the Clear Perform flag is set to ON.
2. After the counter is cleared, the Clear Completed flag is set to ON.
3. After confirming that the Clear Completed flag is set to ON, the Clear Perform flag is set to OFF.
4. After confirming that the Clear Perform flag is set to OFF, the Clear Completed flag is set to OFF.

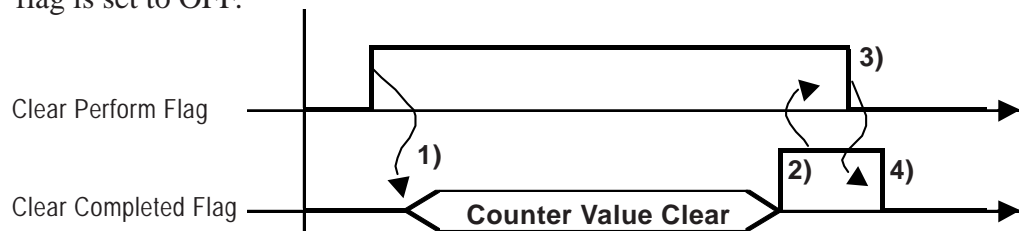

### ■ Preload

When using the Preload feature, the counter's current value can be easily changed to any desired value. The Preload feature allows you to set a specific value from where counting begins. Writing of this value can be done via an External Input, or a Request Flag.

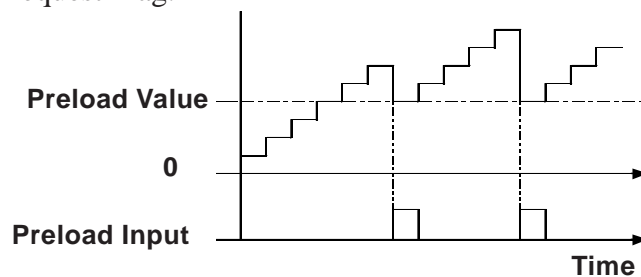

### ◆ Overview

Use the following steps to enter the Preload setting value.

1. Set the Preload value.
2. Use [Special I/O Parameter Setting Change Request] to enter the parameter.
3. Use [Special I/O Parameter Setting Change Completed] to check the parameter.
4. Use External Input, or a Request Flag to change/overwrite the value.
5. If External Input is used to change the value, use [Counter Input External Input Completed Display] to check the value.
6. If Request Flag is used to change the value, use [Special I/O Status] to check the value.



If the [Special I/O Parameter Setting Change Request] and [Special I/O Parameter Setting Change Completed] features are used, they will be reflected in all the parameters of the group being changed.

◆ **Preload Value Setting Method**

To set the Preload value, click on the [Configure I/O] area's [High-Speed Counter | PreloadValue] selection.

**Setting Procedure**

- 1) Allocate a variable to the [Configure I/O] area's [High-Speed Counter | PreloadValue] selection.

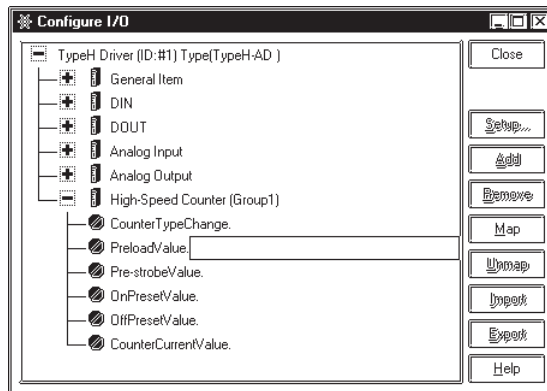

- 2) Save the Preload variable's value.
- 3) Allocate variables to the [Special I/O Parameter Setting Change Request] and [Special I/O Parameter Setting Change Completed] selections.

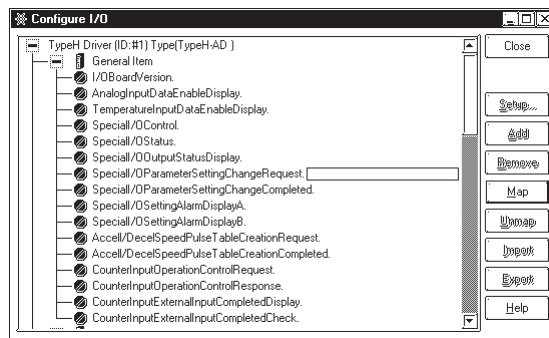

4. The [Special I/O Parameter Setting Change Request] detailed settings should be like the drawing below, i.e. showing to which group a counter is allocated. The bits used will change, depending on how this allocation is set.

15	13	12		9	8		5	4		1	0
Not used	h	g	Not used	f	e	Not used	d	c	Not used	b	a

- a: Group 1 Special I/O Parameter Setting Change Request
- c: Group 2 Special I/O Parameter Setting Change Request
- e: Group 3 Special I/O Parameter Setting Change Request
- g: Group 4 Special I/O Parameter Setting Change Request

The readout of the operation bit for the previously set values is as follows.

- b: Group 1 Special I/O Parameter Setting Read Request
- d: Group 2 Special I/O Parameter Setting Read Request
- f: Group 3 Special I/O Parameter Setting Read Request
- h: Group 4 Special I/O Parameter Setting Read Request

5. The following shows the details of the variable assigned to [SpecialI/OParameterSettingChangeCompleted]. The monitoring bits vary depending on the group to which the counter output is assigned.

<b>15</b>	<b>13</b>	<b>12</b>		<b>9</b>	<b>8</b>		<b>5</b>	<b>4</b>		<b>1</b>	<b>0</b>
Not used	h	g	Not used	f	e	Not used	d	c	Not used	b	a

- a: Group 1 Special I/O Parameter Setting Change Completed
- c: Group 2 Special I/O Parameter Setting Change Completed
- e: Group 3 Special I/O Parameter Setting Change Completed
- g: Group 4 Special I/O Parameter Setting Change Completed

The readout of the monitor bit for the previously set values is as follows.

- b: Group 1 Special I/O Parameter Setting Read Completed
- d: Group 2 Special I/O Parameter Setting Read Completed
- f: Group 3 Special I/O Parameter Setting Read Completed
- h: Group 4 Special I/O Parameter Setting Read Completed

6. The timing of the Special I/O Parameter Setting Change Request and the Completed flag is shown in the following chart.

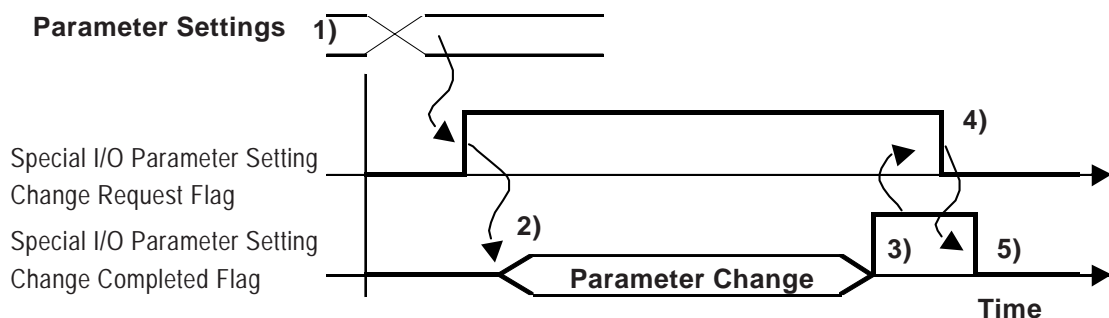

1. Set the Preload value.
2. When the Special I/O Parameter Setting Change Request flag turns ON, the parameter is changed.
3. After the parameter is changed, the completed flag is turned ON.
4. After confirming that the completion flag has turned ON, turn OFF the request flag.
5. The completion flag turns OFF after it is recognized that the request flag is turned OFF.

■ **Using Remote Input or Request Flag to Enter/Change Values.**

You can use either of two triggers to reset the current counter value - Remote Input or Request Flag.

Remote Input Trigger

When the [Group Terminal Settings] feature is used to turn the designated preload input terminal's signal ON, this will write a new preload value. Also, after this input signal is turned ON, you can then perform a value change completion check. The procedure for this check is as follows.

**Confirming Value Changes**

- 1) Allocate a variable to the [Configure I/O] area's [General Item | CounterInput ExternalInputCompletedCheck] and [General Item | CounterInputExternal InputCompleted Display] selections.

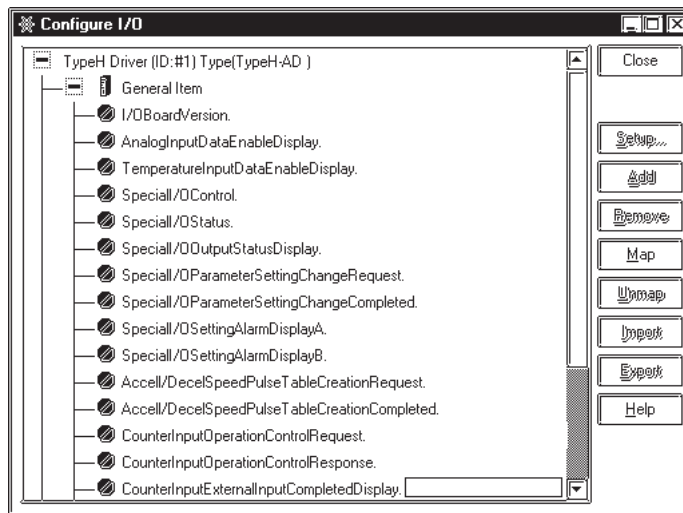

- 2) As shown below, depending on which group the variable in the [General Item | Counter Input External Input Completed Display] selection is allocated to, the monitoring bit used will differ.

15		12	11		8	7		4	3		0
Not used	d	Not used	c	Not used	b	Not used	<input checked="" type="checkbox"/>	a			

- a: Group1 preload completed
- b: Group2 preload completed
- c: Group3 preload completed
- d: Group4 preload completed

- 3) As shown below, depending on which group the variable in the [General Item | Counter Input External Input Completed Check] selection is allocated to, the counter bit used will differ.

15	12	11	8	7	4	3	0
Not used	d	Not used	c	Not used	b	Not used	a

- a: Group1 preload completion check  
 b: Group2 preload completion check  
 c: Group3 preload completion check  
 d: Group4 preload completion check

4. The timing of the [General Item | Counter Input External Input Completed Display] and the [General Item | Counter Input External Input Completed Check] is shown in the following chart.

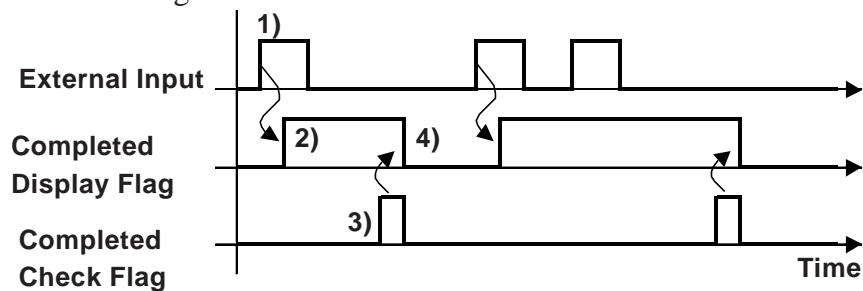

- 1) When the External Input turns ON, the preload value is written.
- 2) After the write, Counter Input External Input Completed Display flag turns ON.
- 3) After confirming that the Counter Input External Input Completed Display flag has turned ON, turn the Counter Input External Input Completed Check flag ON.
- 4) After the Counter Input External Input Completed Check flag ON is recognized, the CounterInput External Input Completed Display flag is turned OFF.

### Request Flag Trigger

- 1) Allocate a variable to the [Configure I/O] area's [General Item | CounterInputOperationControlRequest] and [General Item | CounterInputOperationControlResponse] selections.

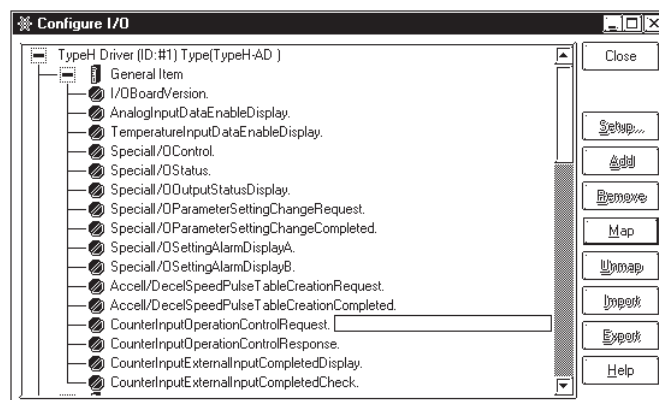

- 2) As shown below, depending on which group the variable in the [General Item | Counter Input Operation Control Request] selection is allocated to, the bit used will differ.

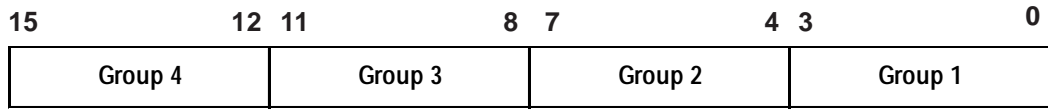

Turning the 2nd bit in a group ON will perform the write.

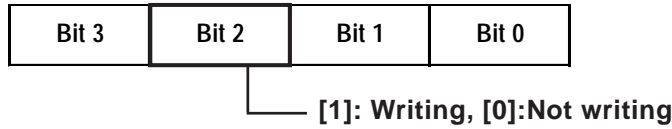

- 3) As shown below, depending on which group the variable in the [General Item | Counter Input Operation Control Response] selection is allocated to, the bit used for monitoring will differ.

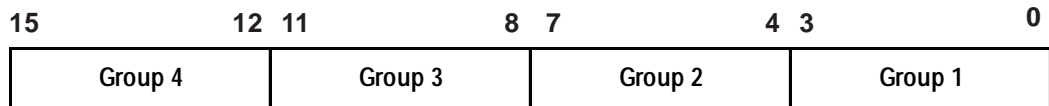

Writing a “1” to the 2nd bit will signal the write is completed, and a “0” will say that it is not completed.

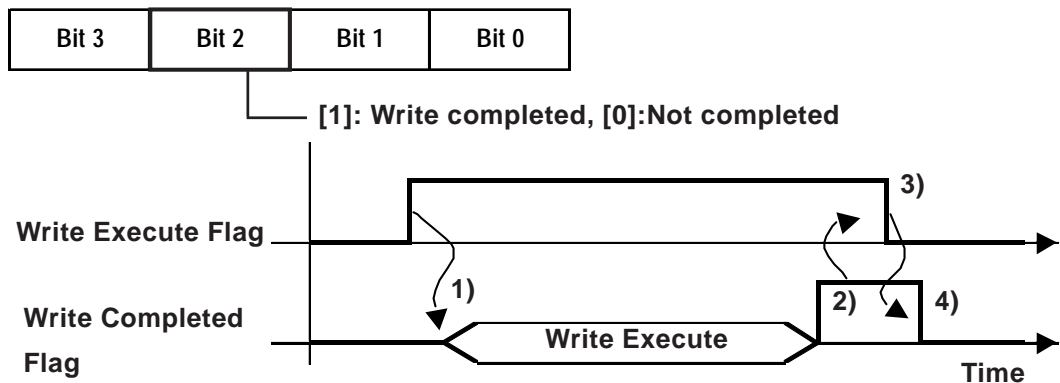

- 1) Write will be executed when the Counter Input Operation Control Request flag turns ON.
- 2) After writing, the Write Completed flag turns ON.
- 3) After confirming that the Write Completed flag is ON, turn the Write Execute flag OFF.
- 4) After Write Execute flag is confirmed as being OFF, Write Completed flag also turns OFF.

### ■ Pre-strobe

The Pre-strobe feature is used to record (save) the current count value. Saving of this value can be done via an External Input, or a Request Flag.

#### ◆ Overview

Use the following steps to enter the Pre-strobe setting value.

1. Designate the value used for saving the Counter value.
2. Save the value via an External Input, or a Request Flag.
3. If External Input is used to write the value, use [CounterInputExternal InputCompletedDisplay] to check the value.
4. If Request Flag was used to write the value, use [SpecialI/OStatus] to check the value.



If the [Special I/O Parameter Setting Change Request] and [Special I/O Parameter Setting Change Completed] features are used, they will be reflected in all the parameters of the group being changed.

---

◆ **Setting procedure**

To specify the location for storing the count value, assign a variable to [High-Speed Counter | Pre-strobe Value] in the [Configure I/O] dialog box. This variable stores the count value.

Two methods exist for triggering the storage of the count value: use either an external input or a request flag.

Trigger with an external input:

The count value is stored in the specified variable when the signal from the pre-strobe input terminal specified in [Group Terminal Setting] turns ON.

You can determine whether the storage is successfully completed by checking whether the signal from the pre-strobe input terminal specified in [Group Terminal Setting] has turned ON. The setting procedure is as follows:

Confirm the completion of the storage

1. Assign variables to [General Item | CounterInputExternalInputCompletedDisplay] and [General Item | CounterInputExternalInputCompletedCheck] in the [ConfigI/O] dialog box.

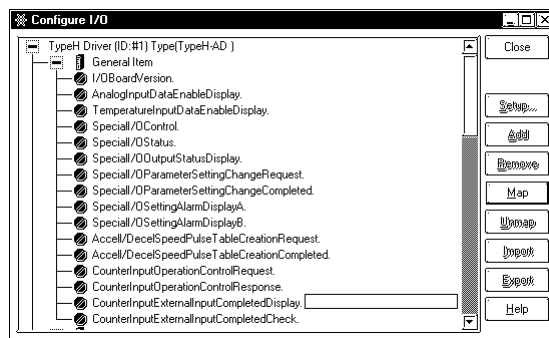

2. The following shows the details of the variable assigned to [Counter Input External Input Completed Display]. The monitoring bits vary depending on the group to which the counter is assigned.

15	12	11	8	7	4	3	0
Not used	d	Not used	c	Not used	b	Not used	a

- a: Group 1 Pre-strobe Completed
- b: Group 2 Pre-strobe Completed
- c: Group 3 Pre-strobe Completed
- d: Group 4 Pre-strobe Completed



3. The following shows the details of the variable assigned to [Counter Input External Input Completed Check]. The operation bits vary depending on the group to which the counter is assigned.

15	12	11	8	7	4	3	0
Not used	d	Not used	c	Not used	b	Not used	a

- a: Group 1 Preload Completion Confirmed
- b: Group 2 Preload Completion Confirmed
- c: Group 3 Preload Completion Confirmed
- d: Group 4 Preload Completion Confirmed

4. The following is the timing chart for [Counter Input External Input Completed Display] and [Counter Input External Input Completed Check].

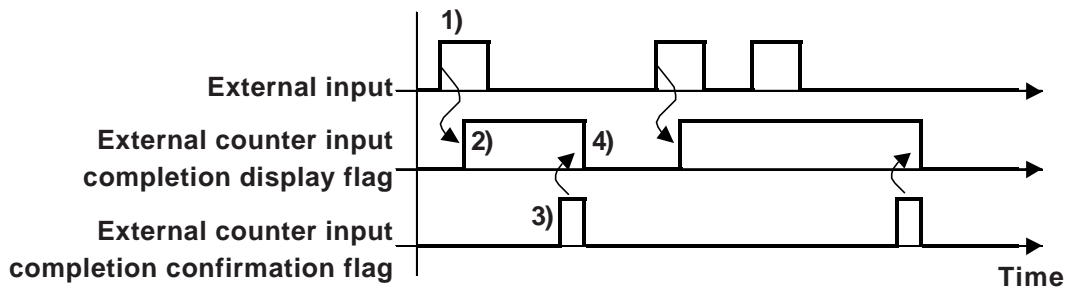

- 1) When the external input is turned ON, the count value is stored in the specified variable.
- 2) After the value has been stored, the external counter input completion display flag turns ON.
- 3) After confirming that the external counter input completion display flag has turned ON, turn ON the external counter input completion confirmation flag.
- 4) The external counter input completion display flag turns OFF after it has been recognized that the external counter input completion confirmation flag has turned ON.

### Trigger via request flag

1. Assign a variable to [General Item | CounterInputOperationControlRequest] in the [Configure I/O] dialog box.

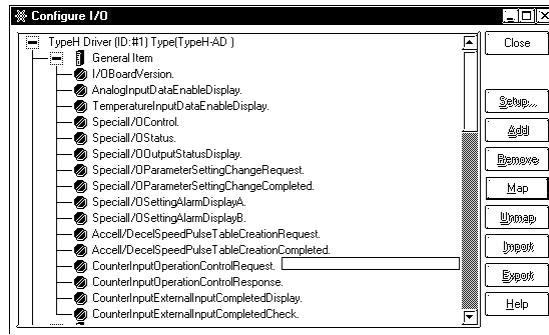

2. The following shows the details of the variable assigned to [Counter Input Operation Control Request]. The operation bits vary depending on the group to which the counter is assigned.

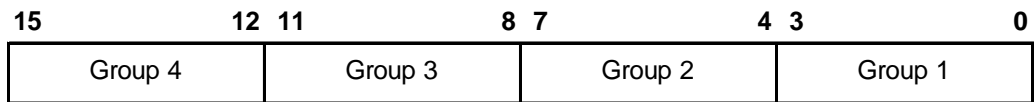

When bit 3 of each group turns ON, the current count value is written.

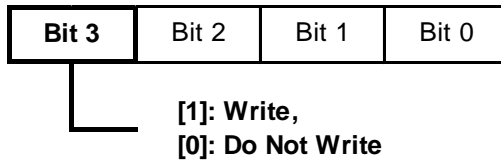

3. The following shows the details of the variable assigned to [Counter Input Operation Control Response]. The monitoring bits vary depending on the group to which the counter is assigned.

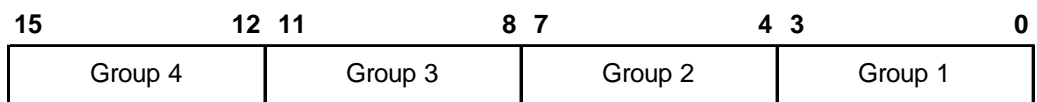

When bit 3 of each group is "1", the count value has been written. When it is "0", the count value has not been written.

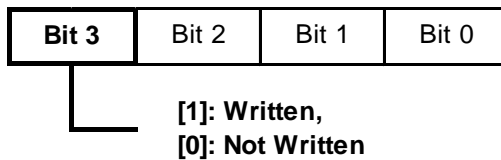

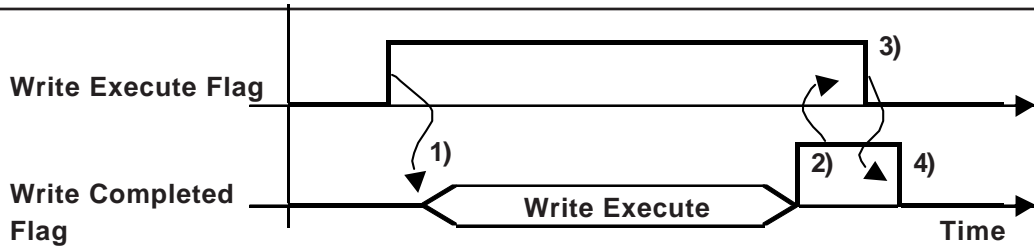

- 1) Write is executed when the Counter Input Operation Control flag is set ON.
- 2) After write is completed, the Write Completed flag is set ON.
- 3) After Write Completed Flag ON is confirmed, turn Write Execute flag OFF.
- 4) After Write Execute Flag OFF is confirmed, Write Completed flag turns OFF.

### ■ Synch. output

Synch. output is designed to output (turns) ON (or OFF) when the Counter Input value exceeds the ON Preset value, or output (turns) OFF (or ON) when the Input value exceeds the OFF Preset value.

The timing of this output, since it is designed to only output (change status) when the counter value either exceeds the ON preset or exceeds the OFF preset, will maintain this condition even if the Counter value is changed via the Preload Input or the Count Value Clear Input.

Also, during Synch. Output, even if the Special I/O Control Request's Synch. Output Enable/Disable Flag turns ON (or if the flag's ON conditions are met), Synch. Output will not turn ON.

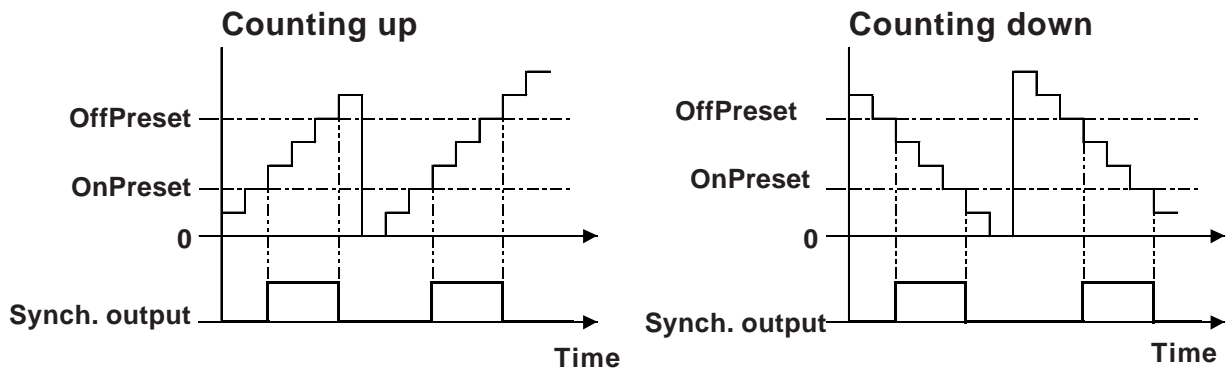

### ◆ Summary

The following is a summary of the setting procedure for the Synch. output function.

1. Specify the OnPreset and OffPreset values.
2. Set the parameters with [Special I/O Parameter Setting Change Request].
3. Check that the parameters are changed with [Special I/O Parameter Setting Change Completed].
4. Start the output with [Special I/O Control].
5. Confirm the result with [Special I/O Status].



***The [Special I/O Parameter Setting Change Request] and [Special I/O Parameter Setting Change Completed] features are reflected in all the parameters in a single group.***

◆ **Preset Value Setting Procedure**

1. Assign variables to [OnPresetValue] and [OffPresetValue] in the [High-Speed Counter] of the [Configure I/O] dialog box.

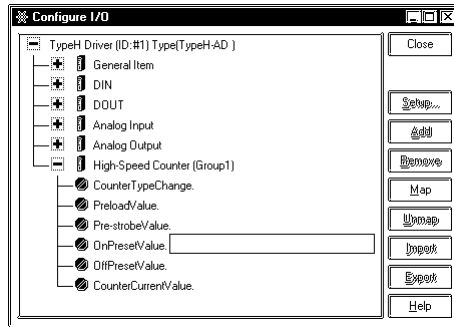

2. Store count values in the variables assigned for the OnPreset and OffPreset values.
3. Assign variables to [General Item | Special I/O Parameter Setting Change Request] and [General Item | Special I/O Parameter Setting Change Completed].

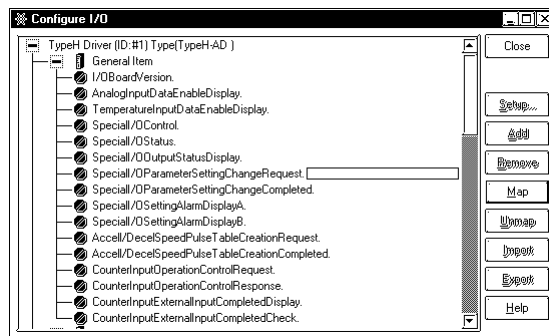

4. The following shows the details of the variable assigned to [Special I/O Parameter Setting Change Request]. The operation bits vary depending on the group to which the counter output is assigned.

15	13	12	9	8	5	4	1	0			
Not used	h	g	Not used	f	e	Not used	d	c	Not used	b	a

- a: Group 1 Special I/O Parameter Setting Change Request
- c: Group 2 Special I/O Parameter Setting Change Request
- e: Group 3 Special I/O Parameter Setting Change Request
- g: Group 4 Special I/O Parameter Setting Change Request

The trigger bits for activating reading of the preset value are as follows:

- b: Group 1 Special I/O Parameter Setting Read Request
- d: Group 2 Special I/O Parameter Setting Read Request
- f: Group 3 Special I/O Parameter Setting Read Request
- h: Group 4 Special I/O Parameter Setting Read Request

5. The following shows the details of the variable assigned to [Special I/O Parameter Setting Change Completed]. The monitoring bits vary depending on the group to which the counter output is assigned.

15	13	12	9	8	5	4	1	0			
Not used	h	g	Not used	f	e	Not used	d	c	Not used	b	a

- a: Group 1 Special I/O Parameter Setting Change Completed
- c: Group 2 Special I/O Parameter Setting Change Completed
- e: Group 3 Special I/O Parameter Setting Change Completed
- g: Group 4 Special I/O Parameter Setting Change Completed

The trigger bits for activating reading of the preset value are as follows:

- b: Group 1 Special I/O Parameter Setting Read Completed
- d: Group 2 Special I/O Parameter Setting Read Completed
- f: Group 3 Special I/O Parameter Setting Read Completed
- h: Group 4 Special I/O Parameter Setting Read Completed

6. The following is the timing chart for the request and completion flags for changing the special I/O parameter.

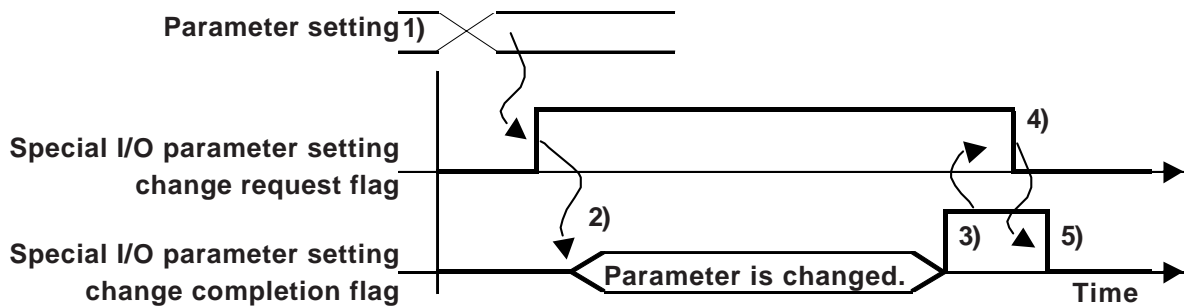

- 1) Specify the ON-preset and OFF-preset values.
- 2) When the special I/O parameter setting change request flag is turned ON, the parameter is changed.
- 3) After the parameter has been changed, the completion flag turns ON.
- 4) After confirming that the completion flag has turned ON, turn OFF the request flag.
- 5) The completion flag turns OFF after it is recognized that the request flag is turned OFF.

◆ **Preset Value Alarm Status**

This is used to display the Synch. Output On or Off Preset Value's alarm status. When #IOStatus shows error code 842, a High speed Counter Parameter Setting alarm will appear. (When any of this item's bits turns ON.)



**When any of the previously explained Special I/O Parameters are changed, if the Preset value is set as a disabled value, operation will continue using the current parameter.**

**Setting Method**

1. Allocate a variable to the [Configure I/O]'s [General Item | Special I/O Setting Alarm DisplayB] selection.

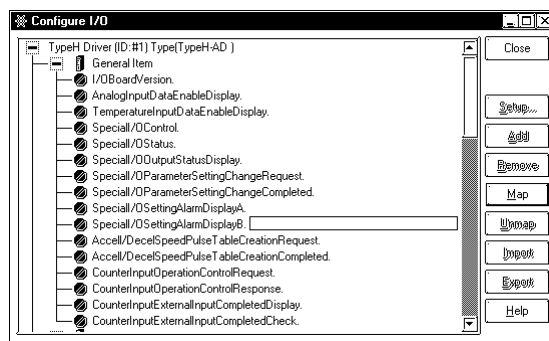

2. The [General Item | Special I/O Setting Alarm Display B] settings are as follows and the bits monitored will depend on which group the counter is allocated to.

15									3	2	1	0
Not used	X	X	X	X	X	X	X	X	d	c	b	a

- a: Group 1 Counter Preset Value alarm [1]: On Preset and Off Preset use same value  
[0]: Normal
- b: Group 2 Counter Preset Value alarm [1]: On Preset and Off Preset use same value  
[0]: Normal
- c: Group 3 Counter Preset Value alarm [1]: On Preset and Off Preset use same value  
[0]: Normal
- d: Group 4 Counter Preset Value alarm [1]: On Preset and Off Preset use same value  
[0]: Normal

◆ **Controlling the Synch. output operation**

You can enable or disable the Synch. output.

**Setting procedure**

1. Assign a variable to [General Item | SpecialI/OControl] in the [Configure I/O] dialog box.

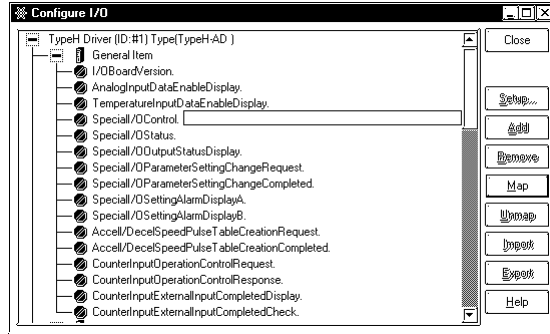

2. The following shows the details of the variable assigned to [Special I/O Control]. The operation bits vary depending on the group to which the counter is assigned.

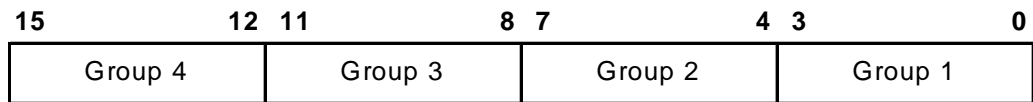

The Synch. output starts when the first bit is turned ON, and stops when the first bit is turned OFF.

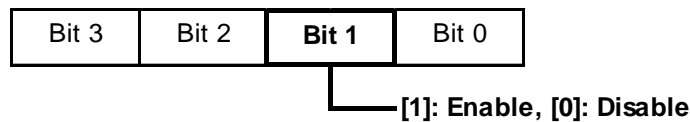

◆ **Synch. output status**

The status of the Synch. output (enabled or disabled) can be determined.

**Setting procedure**

1. Assign a variable to [General Item | SpecialI/OStatus] in the [Configure I/O] dialog box.

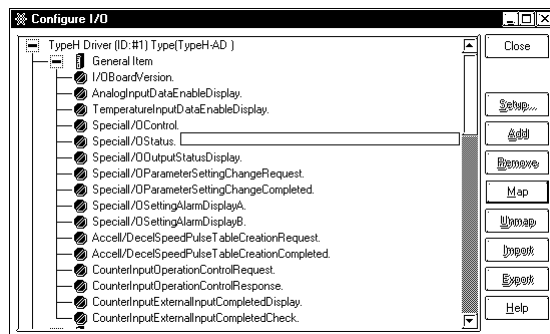

2. The following shows the details of the variable assigned to [Special I/O Status]. The monitoring bits vary depending on the group to which the counter output is assigned.

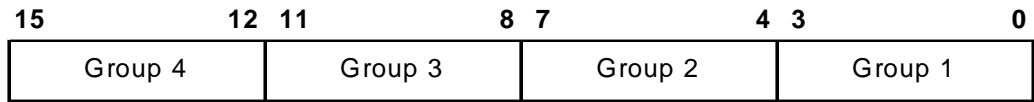

When bit 0 of each group is "1", Synch. output is enabled. When it is "0", Synch. output is disabled.

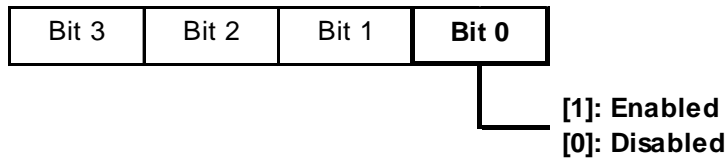

◆ **Clearing outputs during Synch. output**

You can suspend the output while the Synch. output operation is enabled. You can also determine whether the Synch. output has been successfully cleared.

**Setting procedure**

1. Assign variables to [General Item | CounterInputOperationControlRequest] and [General Item | CounterInputOperationControlResponse] in the [Configure I/O] dialog box.

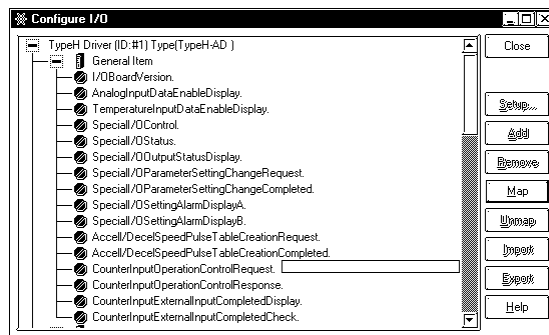

2. The following shows the details of the variable assigned to [Counter Input Operation Control Request]. The operation bits vary depending on the group to which the counter is assigned.

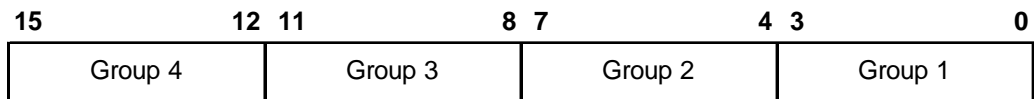

When bit 1 of each group is turned ON, the Synch. output is turned OFF.

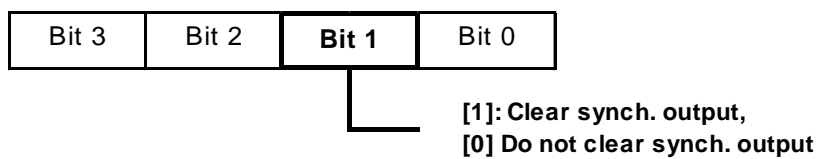



3. The following is the timing chart for the Synch. output operation control and the Synch. output clear flags.

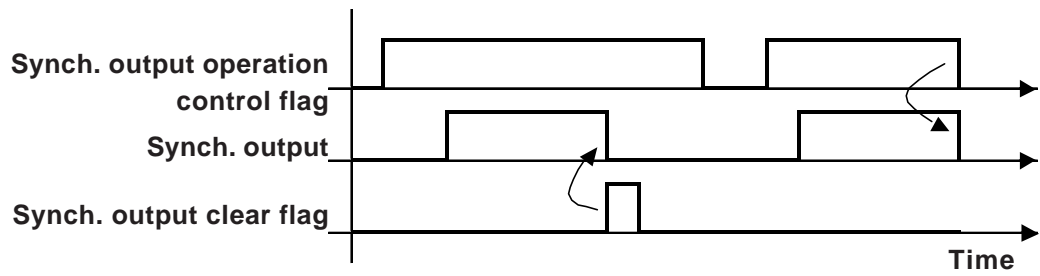

4. The following shows the details of the variable assigned to [Counter Input Operation Control Response]. The monitoring bits vary depending on the group to which the counter is assigned.

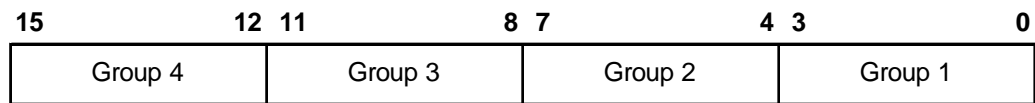

When bit 1 of each group is "1", the Synch. output has been cleared. When it is "0", the Synch. output has not been cleared.

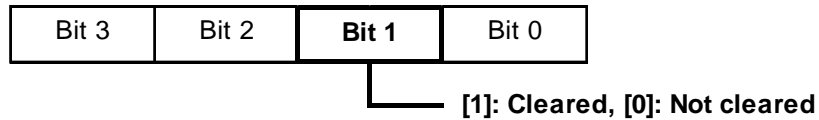

◆ **Synch. output status**

You can check the Synch. output status of output terminals Y0 through Y3.

**Setting procedure**

1. Assign a variable to [General Item | SpecialI/OOutputStatusDisplay ] in the [Configure I/O] dialog box.

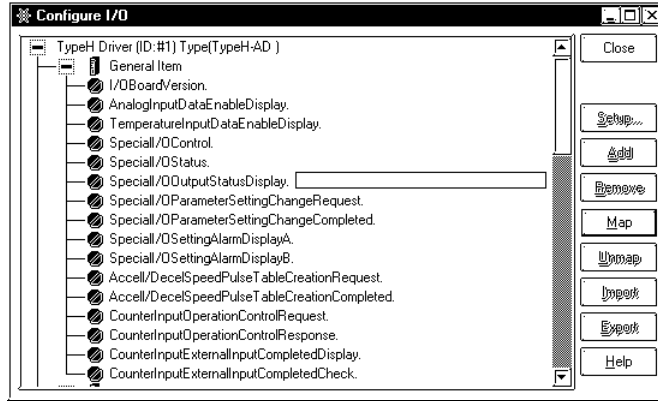

2. The following shows the details of the variable assigned to [Special I/O Output Status Display ]. The monitoring bits vary depending on the group to which the counter output is assigned.

15	12	8	4	0
Not used	d	Not used	b	a

- |                          |      |                       |
|--------------------------|------|-----------------------|
| a: Group 1 Output Status | [1]: | Output being produced |
|                          | [0]: | No output             |
| b: Group 2 Output Status | [1]: | Output being produced |
|                          | [0]: | No output             |
| c: Group 3 Output Status | [1]: | Output being produced |
|                          | [0]: | No output             |
| d: Group 4 Output Status | [1]: | Output being produced |
|                          | [0]: | No output             |

**2.2.7 High-Speed Counter (2-phase)**

The 2-phase Counter is a counter that occupies two input terminals (X0 and X2) to measure 2-phase Input signals. The terminal arrangement to be assigned is slightly different from that of the Single-phase Counter, since the 2-phase counter occupies input terminal X0 of group 1 and X2 of group 2. The functions and setting of the Preload Input, Pre-strobe Input and Synch. Output are the same as those of the Single-phase Counter.

**Reference** "2.2.6 High-speed counter (single-phase)"

The 2-phase Counter offers four measurement modes, "Phase Calculation mode 0" through "Phase Calculation mode 3."

**Phase Calculation mode 0**

When the phase of input 1A leads the phase of input 1B, the counter operates as an up counter. When the phase of input 1A lags the phase of input 1B, the counter operates as a down counter.

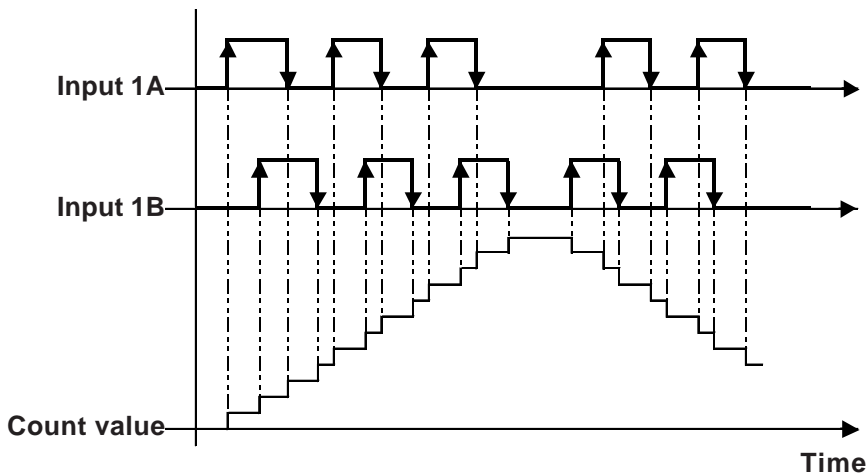

When the phase of input 1A precedes the phase of input 1B

Input 1A	Input 1B	Operation
1 (High)	Rising edge	Counting Up
0 (Low)	Falling edge	
Falling edge	1 (High)	
Rising edge	0 (Low)	

When the phase of input 1A lags the phase of input 1B

Input 1A	Input 1B	Operation
0 (Low)	Rising edge	Counting Down
1 (High)	Falling edge	
Falling edge	0 (Low)	
Rising edge	1 (High)	

**■ Phase Calculation mode 1**

The counter increments/decrements at the rising edge of input 1A. When input 1B is 0 (Low), the counter operates as an up counter. When input 1B is 1 (High), the counter operates as a down counter.

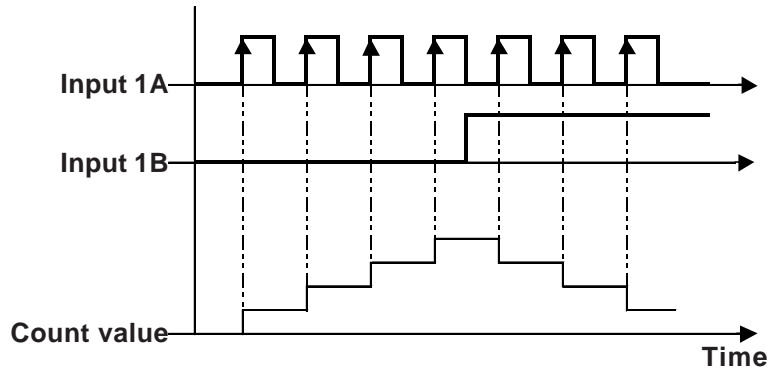

Input 1A	Input 1B	Operation
1 (High)	Rising edge	No count
0 (Low)	Falling edge	
Falling edge	1 (High)	Counting Up
Rising edge	0 (Low)	
0 (Low)	Rising edge	No count
1 (High)	Falling edge	
Falling edge	0 (Low)	Counting Down
Rising edge	1 (High)	

**■ Phase Calculation mode 2**

When input 1B is 0 (Low) at the rising edge of input 1A, the counter operates as an up counter. When input 1A is 0 (Low) at the rising edge of input 1B, the counter operates as a down counter.

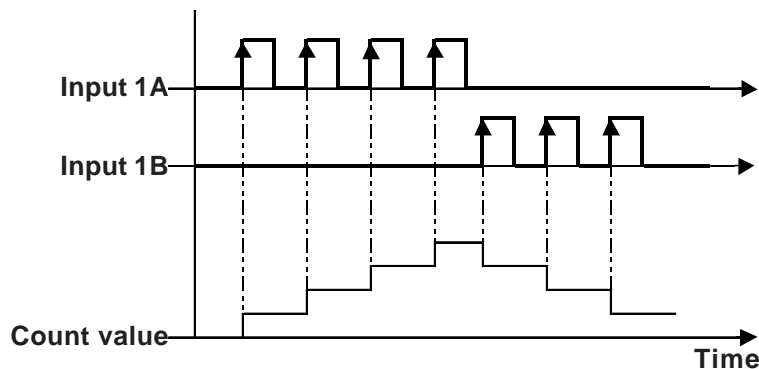

Input 1A	Input 1B	Operation
1 (High)	Rising edge	No count
0 (Low)	Falling edge	
Falling edge	1 (High)	Counting Up
Rising edge	0 (Low)	
0 (Low)	Rising edge	Counting Down
1 (High)	Falling edge	
Falling edge	0 (Low)	No count
Rising edge	1 (High)	

### ■ Phase Calculation mode 3

The counter increments/decrements at the rising and falling edges of input 1B. When input 1A leads input 1B, the counter operates as an up counter. When input 1A lags input 1B, the counter operates as a down counter.

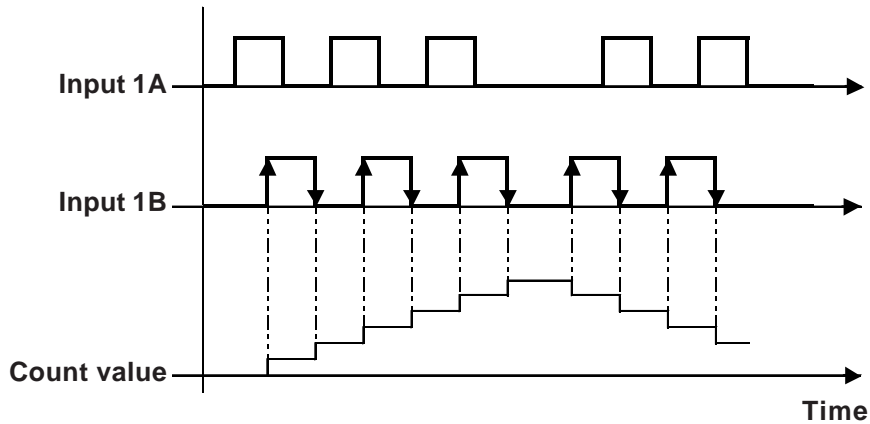

When the phase of input 1A leads the phase of input 1B

Input 1A	Input 1B	Operation
1 (High)	Rising edge	Counting Up
0 (Low)	Falling edge	
Falling edge	1 (High)	Not counting
Rising edge	0 (Low)	

When the phase of input 1A lags the phase of input 1B

Input 1A	Input 1B	Operation
0 (Low)	Rising edge	Counting Down
1 (High)	Falling edge	
Falling edge	0 (Low)	Not counting
Rising edge	1 (High)	

### ■ Phase Calculation Mode Setup

1. Double-click on the [Configure I/O] dialog box's [High-Speed Counter [Group 1]] setting, or, click once on the [High-Speed Counter [Group 1]] setting and click on the [Setup] button. (see image)

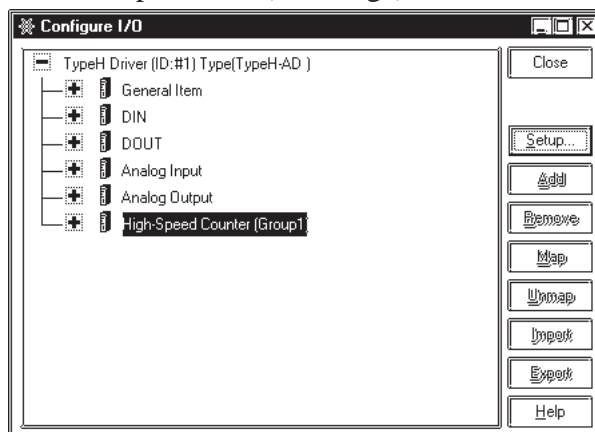

- The [High-Speed Counter Setup] dialog box appears. Counter Value and/or Synch Output Hold is set by selecting the checkbox and clicking [OK].

**Reference** 2.2.5 High-speed counter (Common Settings)

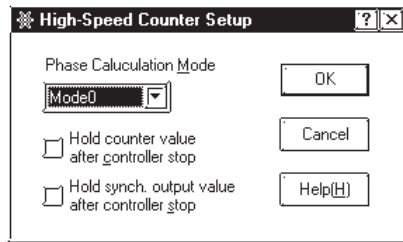

**Marker Input**

The counter value can be cleared with an external input signal while the 2-phase Counter is operating. You can also determine whether the counter value has been successfully cleared.

**Terminals assigned for the marker input**

The input terminal that can be assigned to the Marker Input (external input signal) is only terminal X3 of "Counter 1Z" shown below.

Terminal configuration of group 2 when the 2-phase Counter is used

No.	X2	X3	Y1
1	Counter 1B	Counter Input 1Z (Marker Input)	Standard Output
2			PWM Output
3			Pulse Output
4		Standard Input	Standard Output
5			PWM Output
6			Pulse Output

**Confirming marker input**

- Assign variables to [General Item | CounterInputExternalInputCompletedDisplay] and [General Item | CounterInputExternalInputCompletedCheck ] of the [Configure I/O] dialog box.

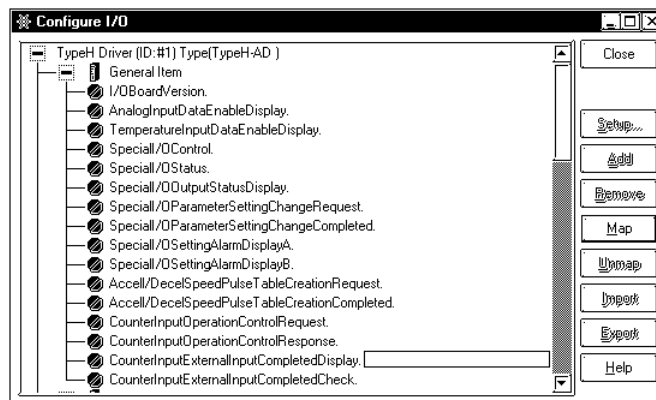

2. Bit 1 of the variable assigned to [Counter Input External Input Completed Display] acts as the input operation completion flag.

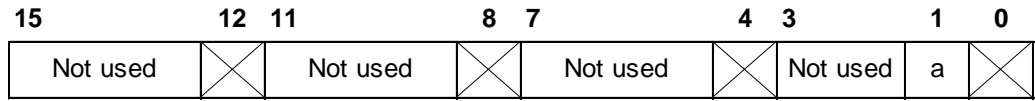

a: Completion of Marker Input operation of 2-phase Counter Input

3. Bit 1 of the variable assigned to [Counter Input External Input Completed Check] acts as the input operation completion confirmation flag.

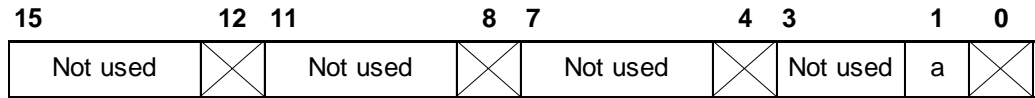

a: Confirmation of completion of Marker Input operation of 2-phase Counter Input

4. The following is the timing chart of [Counter Input External Input Completed Display] and [Counter Input External Input Completed Check].

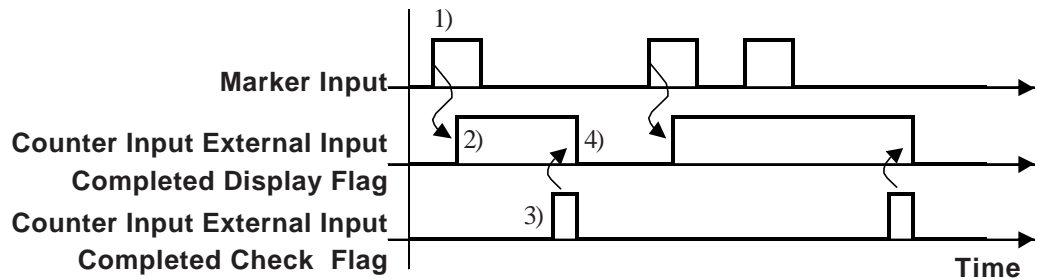

- 1) When the Marker Input turns ON, the count value is cleared.
- 2) After the count value has been cleared, the Counter Input External Input Completed Display flag turns ON.
- 3) After confirming that the Counter Input External Input Completed Display flag has turned ON, turn ON the Counter Input External Input Completed Check flag.
- 4) The Counter Input External Input Completed Display flag turns OFF after the Counter Input External Input Completed Check flag's ON condition is detected.

## 2.2.8 PWM Output

PWM Output is a function that outputs signals at the specified Output Frequency at a specified On Duty ratio. Up to four output channels can be used for PWM Output and each channel can be specified individually.

### ■ Summary

The following is a summary of the setting procedure for PWM Output.

1. Specify the Output Frequency and On Duty value.
2. Set the parameters with [Special I/O Parameter Setting Change Request].
3. Check the parameters with the [Special I/O Parameter Setting Change Completed] feature.
4. Start the output with [Special I/O Control].
5. Confirm the output with [Special I/O Status].



***The [Special I/O Parameter Setting Change Request] and [Special I/O Parameter Setting Change Completed] features are reflected in all the parameters in a single group.***

### ■ Output Frequency

Specify the output frequency. The available range is from 10Hz to 2.5kHz.

### ◆ Setting procedure

1. Assign a variable to [OutputFrequency] of [PWM Output] in the [Configure I/O] dialog box.

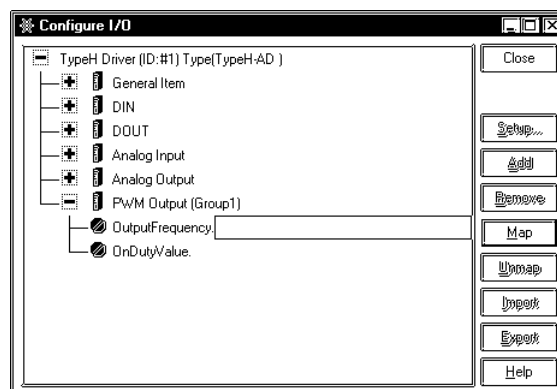

2. Store a desired frequency value in the variable assigned for [Output Frequency].



■ **OnDuty**

OnDuty is the ratio between the ON time and OFF time of a pulse, specified as a percentage (%).

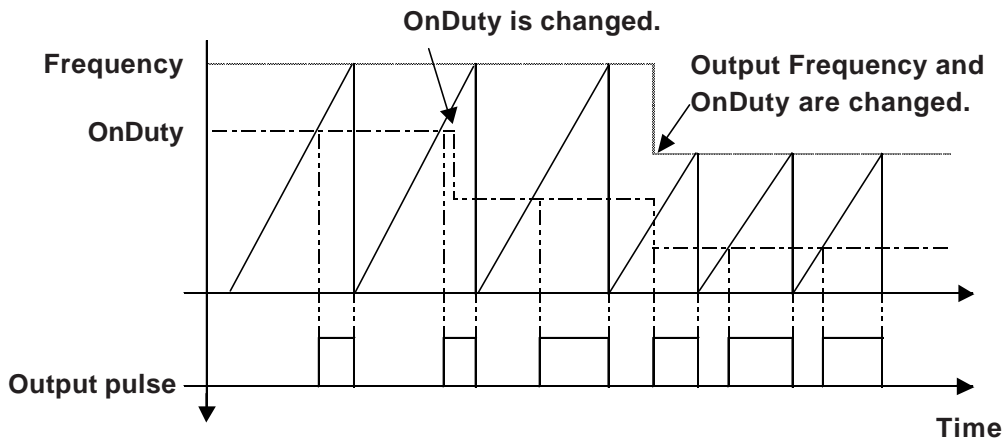

■ **OnDuty ratio Effective range**

The higher the frequency, the less the output waveform resembles the intended form specified with the OnDuty ratio. Therefore, if the Output Frequency is high, correct the output waveform by setting the OnDuty value within the effective range.

◆ **Calculation of the effective range**

Use the following expression to obtain the upper and lower limit values for the effective range of the OnDuty Value:

Upper limit value:  $100 - \text{Hardware delay time } (\mu\text{s}) \times \text{Frequency}$

Lower limit value:  $\text{Hardware delay time } (\mu\text{s}) \times \text{Frequency}$



**The hardware delay time is the total of the ON -> OFF time (Time required for the voltage to drop to 2.4 V, or 10% of 24 V) and the OFF -> ON time (time required for the voltage to increase to 21.6 V, or 90% of 24 V).**

Example: When the hardware delay time is 40 μs and the output frequency is 2000Hz:

Upper limit value:  $100 - 40 \times 10^{-4} \times 2000 = 92 (\%)$

Lower limit value:  $40 \times 10^{-4} \times 2000 = 8 (\%)$

Thus, the effective range of the OnDuty value is 8 to 92%.

### ◆ Setting procedure

1. Assign a variable to [OnDutyValue] in [PWM Output] of the [Configure I/O] dialog box.

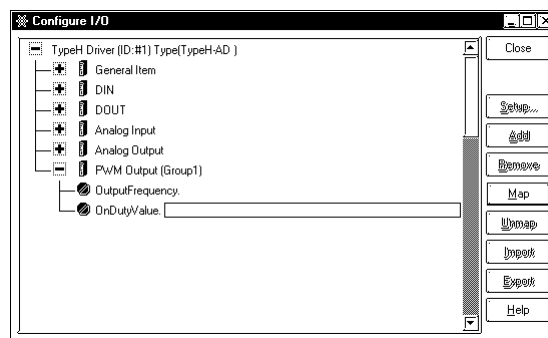

2. Store the OnDuty value in the variable that is assigned to the [On Duty Value].

### ■ Confirming the parameter change request and parameter change completion.

The parameters for the Output Frequency and OnDuty value are changed with [Special I/O Parameter Setting Change Request].

### ◆ Setting procedure

1. Assign variables to [General Item | SpecialI/OParameterSettingChangeRequest] and [General Item | SpecialI/OParameterSettingChangeCompleted] in the [Configure I/O] dialog box.

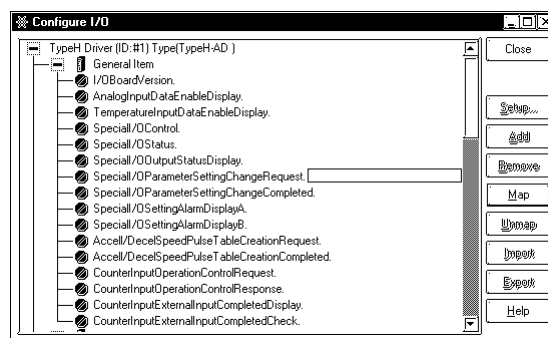

2. The following shows the details of the variable assigned to [Special I/O Parameter Setting Change Request]. The operation bits vary depending on the group to which the PWM Output is assigned.

<b>15</b>	<b>13</b>	<b>12</b>		<b>9</b>	<b>8</b>		<b>5</b>	<b>4</b>		<b>1</b>	<b>0</b>
Not used	h	g	Not used	f	e	Not used	d	c	Not used	b	a

- a: Group 1 special I/O parameter setting change request
- c: Group 2 special I/O parameter setting change request
- e: Group 3 special I/O parameter setting change request
- g: Group 4 special I/O parameter setting change request

The trigger bits for activating reading of the preset value are as follows:

- b: Group 1 special I/O parameter setting read request
- d: Group 2 special I/O parameter setting read request
- f: Group 3 special I/O parameter setting read request
- h: Group 4 special I/O parameter setting read request

3. The following shows the details of the variable assigned to [Special I/O Parameter Setting Change Completed]. The monitoring bits vary depending on the group to which the PWM Output is assigned.

<b>15</b>	<b>13</b>	<b>12</b>		<b>9</b>	<b>8</b>		<b>5</b>	<b>4</b>		<b>1</b>	<b>0</b>
Not used	h	g	Not used	f	e	Not used	d	c	Not used	b	a

- a: Group 1 special I/O parameter setting change completion
- c: Group 2 special I/O parameter setting change completion
- e: Group 3 special I/O parameter setting change completion
- g: Group 4 special I/O parameter setting change completion

The trigger bits for activating reading of the preset value are as follows:

- b: Group 1 special I/O parameter setting read completion
- d: Group 2 special I/O parameter setting read completion
- f: Group 3 special I/O parameter setting read completion
- h: Group 4 special I/O parameter setting read completion

4. The following is the timing chart for the request and completion flags for changing the special I/O parameter.

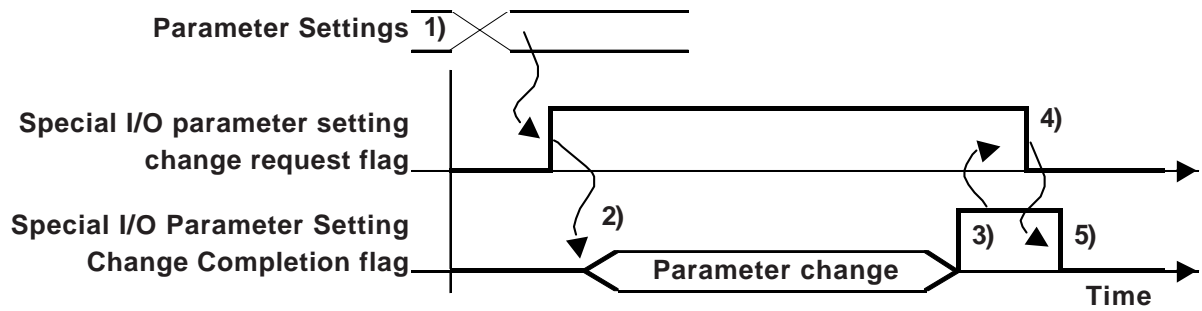

- 1) Set the Output Frequency and the OnDuty values.
- 2) When the special I/O parameter setting change request flag is turned ON, the parameter is changed.
- 3) After the parameter has been changed, the completion flag turns ON.
- 4) After confirming that the completion flag has turned ON, turn OFF the request flag.
- 5) The completion flag turns OFF after it is recognized that the request flag is turned OFF.

### ■ PWM Output alarm status

Displays the Alarm status of the Output Frequency and OnDuty Value of the PWM Output. When the #IOStatus shows an error code of 842, a PWM Output parameter setting alarm will appear (one of this feature's bits will turn ON.)



***When any of the previously explained Special I/O Parameters are changed, if the Preset value is set as a disabled value, operation will continue using the current parameter.***

### ◆ Setting procedure

1. Assign a variable to [General Item | SpecialI/OSettingAlarmDisplayA] in the [Configure I/O] dialog box.

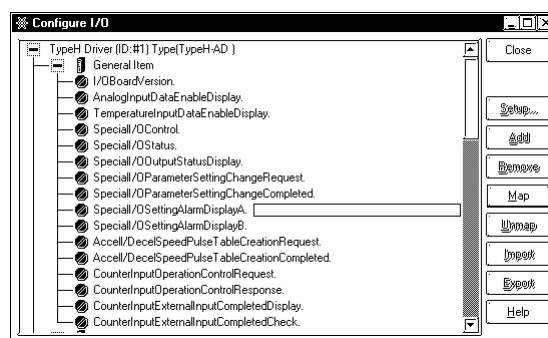

2. The following shows the details of the variable assigned to [Special I/O Setting Alarm Display A]. The monitoring bits vary depending on the group to which the PWM output is assigned.

<b>15</b>						<b>7</b>	<b>6</b>	<b>5</b>	<b>4</b>	<b>3</b>	<b>2</b>	<b>1</b>	<b>0</b>
X	Not used	X	X	X	X	h	g	f	e	d	c	b	

- a: Alarm Output Frequency for Group 1 PWM Output [1]: Exceeds 2.5kHz  
[0]: Normal
- b: Alarm OnDuty Value for Group 1 PWM Output [1]: Out of effective ON-duty range,  
[0]: Normal
- c: Alarm Output Frequency for Group 2 PWM Output [1]: Exceeds 2.5kHz  
[0]: Normal
- d: Alarm OnDuty Value for Group 2 PWM Output [1]: Out of effective ON-duty range  
[0]: Normal
- e: Alarm Output Frequency for Group 3 PWM Output [1]: Exceeds 2.5kHz  
[0]: Normal
- f: Alarm OnDuty Value for Group 3 PWM Output [1]: Out of effective ON-duty range  
[0]: Normal
- g: Alarm Output Frequency for Group 4 PWM Output [1]: Exceeds 2.5kHz,  
[0]: Normal
- h: Alarm OnDuty Value for Group 4 PWM Output [1]: Out of effective ON-duty range  
[0]: Normal

### ■ PWM Output control

Starts or stops PWM Output.

#### ◆ Setting procedure

1. Assign a variable to [General Item | SpecialI/OControl] in the [Configure I/O] dialog box.

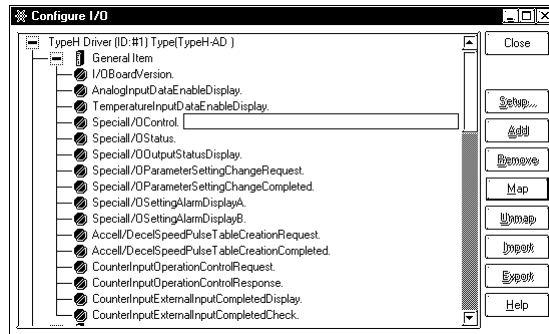

2. The following shows the details of the variable assigned to [Special I/O Control]. The operation bits vary depending on the group to which the PWM Output is assigned.

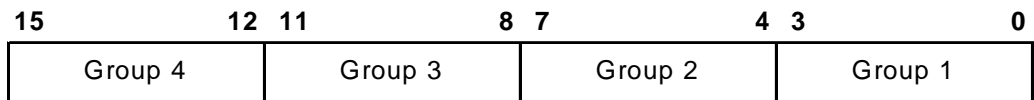

PWM output starts when the first bit (bit 0) is turned ON, and stops when the first bit is turned OFF.

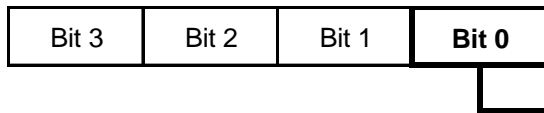

[1]: Start, [0]: Stop

### ■ PWM Output status

The status of PWM Output can be checked.

#### ◆ Setting procedure

1. Assign a variable to [General Item | SpecialI/OStatus] in the [Configure I/O] dialog box.

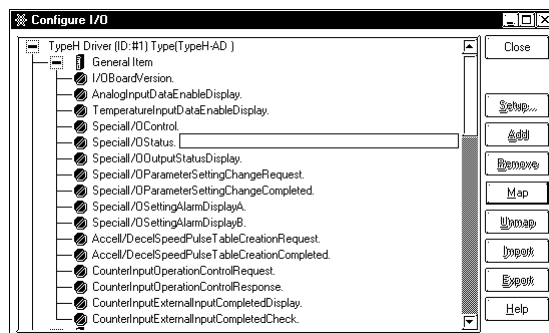

- The following shows the details of the variable assigned to [Special I/O Status]. The monitoring bits vary depending on the group to which the PWM Output is assigned.

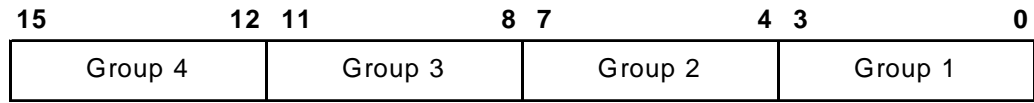

When the first bit (bit 0) is "1", the PWM Output is in operation. When it is "0", the PWM Output is stopped.

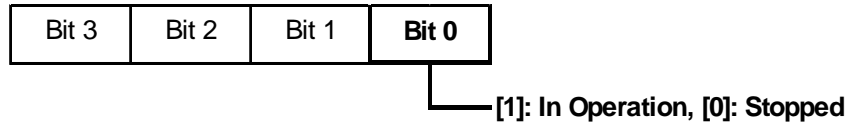

### ■ PWM Output terminal status

You can determine the status of PWM Output for output terminals Y0 through Y3.

#### ◆ Setting procedure

- Assign a variable to [General Item | SpecialI/OOutputStatusDisplay] in the [Configure I/O] dialog box.

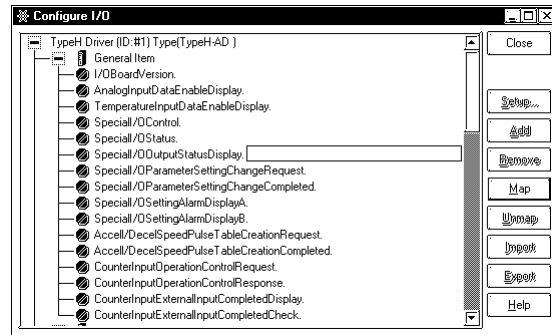

- The following shows the details of the variable assigned to [Special I/O Output Status Display]. The monitoring bits vary depending on the group to which PWB Output is assigned.

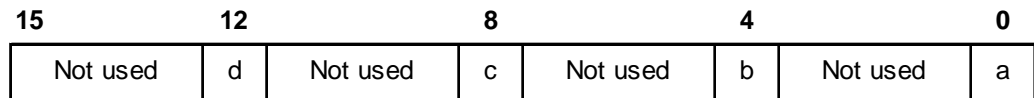

- |                          |      |                       |
|--------------------------|------|-----------------------|
| a: Group 1 Output Status | [1]: | Output being produced |
|                          | [0]: | No output             |
| b: Group 2 Output Status | [1]: | Output being produced |
|                          | [0]: | No output             |
| c: Group 3 Output Status | [1]: | Output being produced |
|                          | [0]: | No output             |
| d: Group 4 Output Status | [1]: | Output being produced |
|                          | [0]: | No output             |

## 2.2.9 Normal Pulse Output

Two types of pulse output are available: Normal Pulse Output, which outputs the specified number of pulses at the specified frequency; and Acceleration/Deceleration Speed Pulse Output, which gradually increases frequencies until the specified frequency is reached.

**Reference** "2.2.10 Acceleration/Deceleration Speed Pulse Output"

Connecting a CW, CCW stepping motor or servo amp, a positioning control motor can be operated.

### ■ Summary

The following is a summary of the setting procedure for pulse output.

1. Specify the output frequency and the number of output pulses.
2. Request the change of parameters with [Special I/O Parameter Setting Change Request].
3. Request the check of parameter change with [Special I/O Parameter Setting Change Completed].
4. Start the output with [Special I/O Control].
5. Check the output with [Special I/O Status].



- ***The [Special I/O Parameter Setting Change Request] and [Special I/O Parameter Setting Change Completed] features are reflected in all the parameters in a single group.***
- ***The pulse output default frequency is 10Hz.***
- ***If pulse output is turned from OFF to ON, then from ON to OFF, a single output is produced. Even though the output pulse amount's count is updated using ON to OFF timing, if pulse output is used for a forced stop, the forced stop pulse may not be counted, due to the need to stop the operation immediately.***

### ■ Output Frequency

Specify the Output Frequency. The available range is between 10Hz and 5kHz. When several groups are used for pulse output, the total Output Frequency must not exceed 5kHz.

Also, while two types of pulses, normal and Accel/Decel, can be set for a group, the Output Frequency total check will use whichever value is larger, the Accel/Decel Speed Pulse Frequency or the Normal Pulse Output's Output Frequency.

**Reference** "2.2.10 Acceleration/Deceleration Speed Pulse Output"



◆ Example of Pulse Output Output Frequency Parameter Changes

	Initial Setting	Parameter Change		Actual Frequency After Parameter Change
Group	Frequency (Hz)	Frequency (Hz)		Frequency (Hz)
1	500	2000	NG	500
2	1000	1500	NG	1000
3	1500	1000	OK	1000
4	2000	500	OK	500

When the above parameter changes are made, the following actions occur.

**Initial Settings and then Table Creation**

1. When "2000Hz" is set for Group 1, the total output frequency at this time (6500Hz) exceeds the allowed maximum of 5000Hz, and therefore the unit operates at the initial setting of 500Hz.

$$2000 + 1000 \text{ (Group 2:Initial)} + 1500 \text{ (Group 3:Initial)} + 2000 \text{ (Group 4:Initial)} = 6500$$

2. When "1500Hz" is set for Group 2, the total output frequency at this time (5500Hz) exceeds the allowed maximum of 5000Hz, and therefore the unit operates at group 2's initial setting of 1000Hz and 1500Hz is not used.

$$500 \text{ (Group 1:Initial)} + 1500 + 1500 \text{ (Group 3:Initial)} + 2000 \text{ (Group 4:Initial)} = 5500$$

3. When "1000Hz" is set for Group 3, the total output frequency at this time (4500Hz) is within the allowed maximum of 5000Hz, and therefore the unit operates at the new setting of 1000Hz.

$$500 \text{ (Group 1:Initial)} + 1000 \text{ (Group 2:Initial)} + 1000 + 2000 \text{ (Group 4:Initial)} = 4500$$

4. When "500Hz" is set for Group 4, the total output frequency at this time (3000Hz) is within the allowed maximum of 5000Hz, and therefore the unit operates at the new setting of 500Hz.

$$500 \text{ (Group 1:Initial)} + 1000 \text{ (Group 2:Initial)} + 1000 \text{ (Group 3:Initial)} + 500 = 3000$$

◆ Setting procedure

1. Assign a variable to [OutputFrequency] of [Pulse Output] in the [Configure I/O] dialog box.

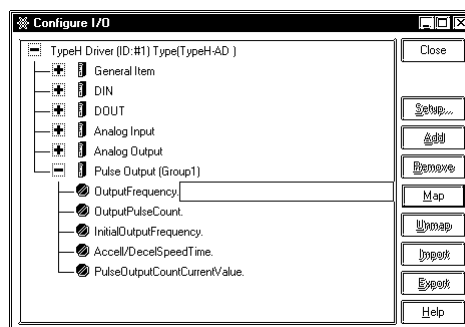

2. Store the value of the output frequency in the variable assigned for [Output Frequency]. Store the value of the number of output pulses in the variable assigned for [Output Pulse Count].

## ■ Number of output pulses

You can specify the number of pulses to be output. The available range is from 0 to 65535.



***If the number of output pulses is changed during pulse output and the specified value is less than the number of pulses that have been output by that time, pulse output will stop.***

### ◆ Setting procedure

1. Assign variables to [OutputFrequency] and [OutputPulseCount] of [Pulse Output] in the [Configure I/O] dialog box.

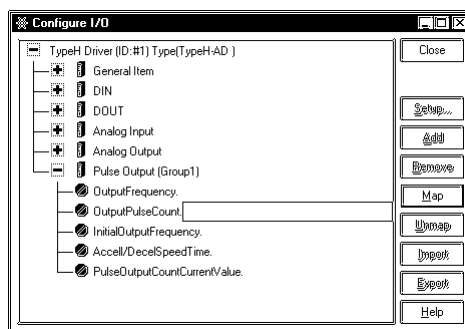

2. Store the value for the number of output pulses in the variable assigned for [Output Pulse Count].

## ■ Confirming parameter change request and parameter change completion

The parameters for the output frequency and the number of output pulses are changed with [Special I/O Parameter Setting Change Request].

### ◆ Setting procedure

1. Assign variables to [General Item | SpecialI/OParameterSettingChangeRequest] and [General Item | SpecialI/OParameterSettingChangeCompleted] in the [Configure I/O] dialog box.

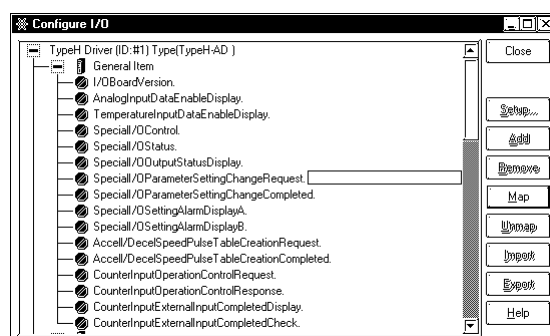

2. The following shows the details of the variable assigned to [Special I/O Parameter Setting Change Request]. The operation bits vary depending on the group to which the pulse output is assigned.

<b>15</b>	<b>13</b>	<b>12</b>		<b>9</b>	<b>8</b>		<b>5</b>	<b>4</b>		<b>1</b>	<b>0</b>
Not used	h	g	Not used	f	e	Not used	d	c	Not used	b	a

- a: Group 1 Special I/O parameter Setting Request
- c: Group 2 Special I/O parameter Setting Request
- e: Group 3 Special I/O parameter Setting Request
- g: Group 4 Special I/O parameter Setting Request

The trigger bits for activating reading of the preset value are as follows:

- b: Group 1 Special Parameter Setting Read Request.
- d: Group 2 Special Parameter Setting Read Request.
- f: Group 3 Special Parameter Setting Read Request.
- h: Group 4 Special Parameter Setting Read Request.

3. The following shows the details of the variable assigned to [Special I/O Parameter Setting Change Completed]. The monitoring bits vary depending on the group to which the pulse output is assigned.

<b>15</b>	<b>13</b>	<b>12</b>		<b>9</b>	<b>8</b>		<b>5</b>	<b>4</b>		<b>1</b>	<b>0</b>
Not used	h	g	Not used	f	e	Not used	d	c	Not used	b	a

- a: Group 1 Special I/O Parameter Setting Change Completed
- c: Group 2 Special I/O Parameter Setting Change Completed
- e: Group 3 Special I/O Parameter Setting Change Completed
- g: Group 4 Special I/O Parameter Setting Change Completed

The trigger bits for activating reading of the preset value are as follows:

- b: Group 1 Special I/O Parameter Setting Read Completed.
- d: Group 2 Special I/O Parameter Setting Read Completed.
- f: Group 3 Special I/O Parameter Setting Read Completed.
- h: Group 4 Special I/O Parameter Setting Read Completed.

- The following is the timing chart for the request and completion flags for changing the special I/O parameter.

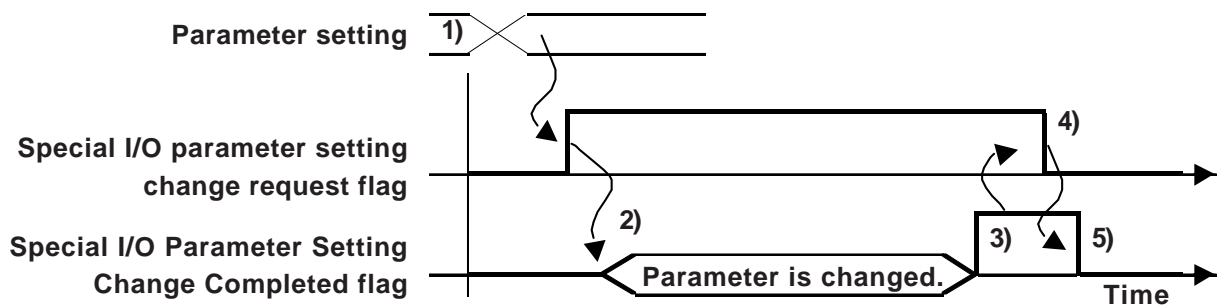

- Set the Output Frequency and the Output Pulse count.
- When the special I/O parameter setting change request flag is turned ON, the parameter is changed.
- After the parameter has been changed, the completion flag turns ON.
- After confirming that the completion flag has turned ON, turn OFF the request flag.
- The completion flag turns OFF after the request flag OFF condition is detected.

## ■ Pulse Output Alarm Status

This feature allows you to determine the alarm status of the Output Frequency, as well as the Total Pulse Output Frequency.

### ◆ Setting procedure

- Assign a variable to [General Item | SpecialI/OSettingAlarmDisplayA] in the [Configure I/O] dialog box.

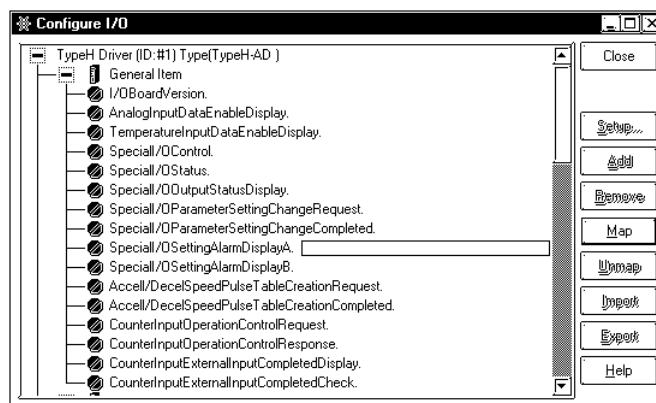

2. The following shows the details of the variable assigned to [Special I/O Setting Alarm Display A]. The monitoring bits vary depending on the group to which the pulse output is assigned.

15		11	10	9	8								0
e	Not used	d	c	b	a	X	X	X	X	X	X	X	X

- a: Group 1 Pulse Output Frequency Alarm [1]: Exceeds 5kHz  
[0]: Normal
- b: Group 1 Pulse Output Frequency Alarm [1]: Exceeds 5kHz  
[0]: Normal
- c: Group 1 Pulse Output Frequency Alarm [1]: Exceeds 5kHz  
[0]: Normal
- d: Group 1 Pulse Output Frequency Alarm [1]: Exceeds 5kHz  
[0]: Normal
- e: Pulse Output Total Frequency Alarm [1]: Total frequency exceeds 5kHz  
[0]: Normal

### ■ Normal pulse output control

Starts or stops pulse output.

### ◆ Setting procedure

1. Assign a variable to [General Item | SpecialI/OControl] in the [Configure I/O] dialog box.

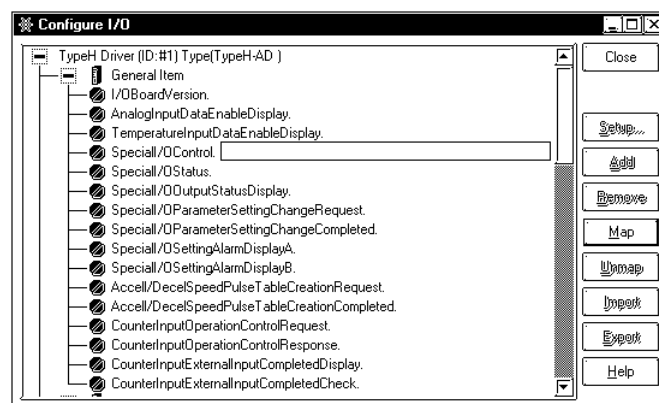

- The following shows the details of the integer variable assigned to [Special I/O Control]. The operation bits vary depending on the group to which the counter is assigned.

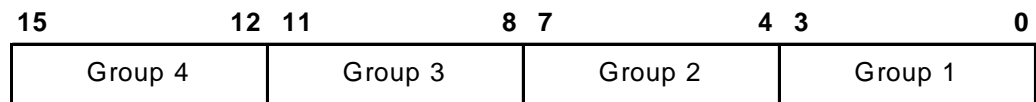

The pulse output starts when the first bit (bit 0) of each group is turned ON, and stops when the first bit is turned OFF.

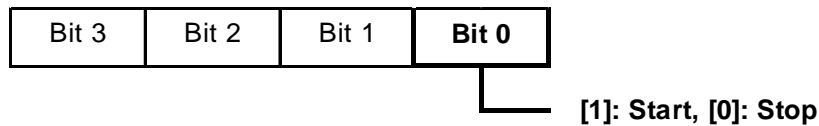

### ■ Normal pulse output status and completion status

You can check the status of operation and the status of normal pulse output completion.

#### ◆ Setting procedure

- Assign a variable to [General Item | SpecialI/OStatus] in the [Configure I/O] dialog box.

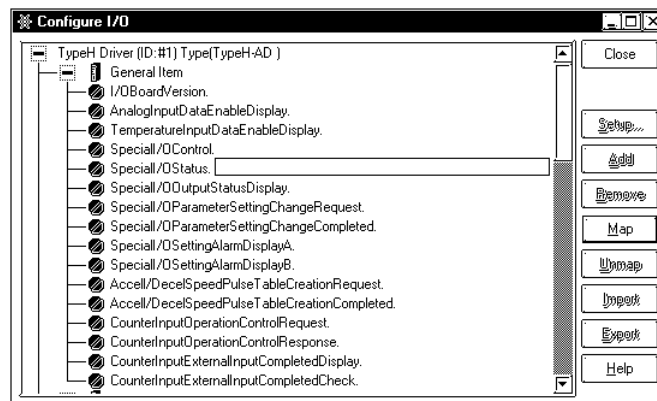

- The following shows the details of the variable assigned to [Special I/O Status]. The monitoring bits vary depending on the group to which the pulse output is assigned.

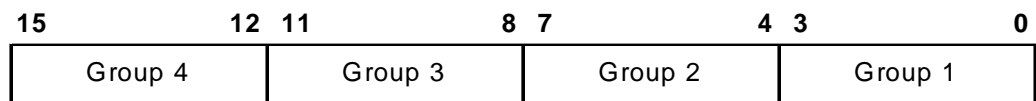

When the first bit (bit 0) of each group is "1", output is enabled. When it is "0", output is disabled.

When bit 2 is "1", the output of the specified number of pulses has been completed.

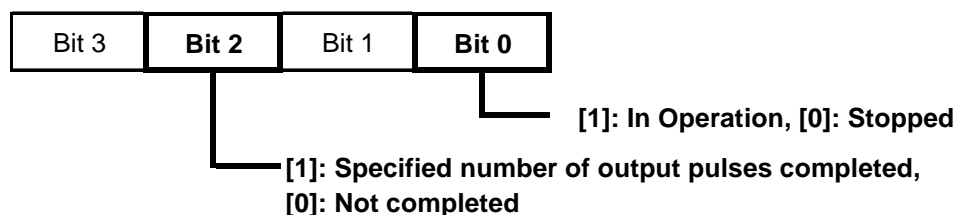

### ■ Pulse output terminal status check

You can check the status of the pulse output for output terminals Y0 through Y3.

#### ◆ Setting procedure

1. Assign a variable to [General Item | SpecialI/OOutputStatusDisplay] in the [Configure I/O] dialog box.

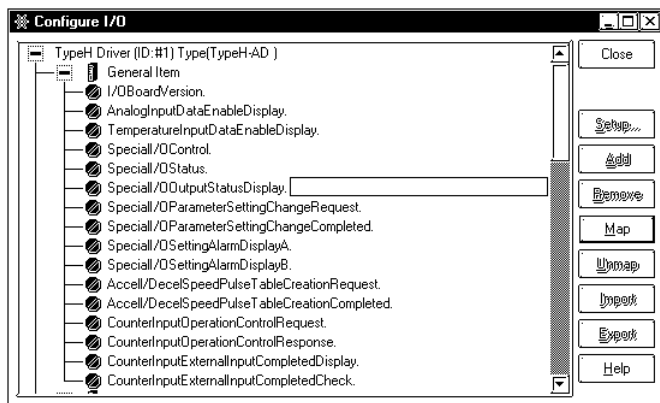

2. The following shows the details of the variable assigned to [Special I/O Output Status Display]. The monitoring bits vary depending on the group to which the pulse output is assigned.

15	12	8	4	0
Not used	d	Not used	c	Not used
			b	Not used
				a

- |                          |      |                       |
|--------------------------|------|-----------------------|
| a: Group 1 Output Status | [1]: | Output being produced |
|                          | [0]: | No output             |
| b: Group 2 Output Status | [1]: | Output being produced |
|                          | [0]: | No output             |
| c: Group 3 Output Status | [1]: | Output being produced |
|                          | [0]: | No output             |
| d: Group 4 Output Status | [1]: | Output being produced |
|                          | [0]: | No output             |

### 2.2.10 Acceleration/Deceleration Speed Pulse Output

Two types of pulse outputs are available: normal pulse output, which outputs the specified number of pulses at the specified frequency; and Acceleration/Deceleration pulse output, which gradually increases frequencies until the specified frequency is reached.

**Reference** "2.2.9 Normal Pulse Output"

#### ■ Summary

The following is a summary of the setting procedure for the Acceleration/Deceleration Speed Pulse Output.

1. Specify the Output Frequency, number of output pulses, Initial Output Frequency and Acceleration/Deceleration Speed Time.
2. Specify parameters with [Accel/Decel Speed Pulse Table Creation Request].
3. Check parameter changes with [Accel/Decel Speed Pulse Table Creation Completed].
4. Turn ON the Acceleration/Deceleration bit specified for [Special I/O Control].
5. Start the output with [Special I/O Control].
6. Check the status with [Special I/O status].

As shown below, the Accel/Decel Pulse Output is used to produce a smooth output frequency time line, as the set number of pulses is reached.

The Pulse Output's Initial Output Frequency begins at ( $F_0$ ) and accelerates in ten discrete steps until it reaches the Standard Output Frequency ( $F$ ). Then, during the following deceleration, from the Standard Output Frequency's pulse level to the desired reduced pulse level, the same 10 steps are used for pulse output.

Be sure when setting the Standard Output Frequency and the Output Pulse Amount settings to also enter the Initial Output Frequency ( $F_0$ ) and the Accel/Decel Speed Time ( $T$ ) settings.

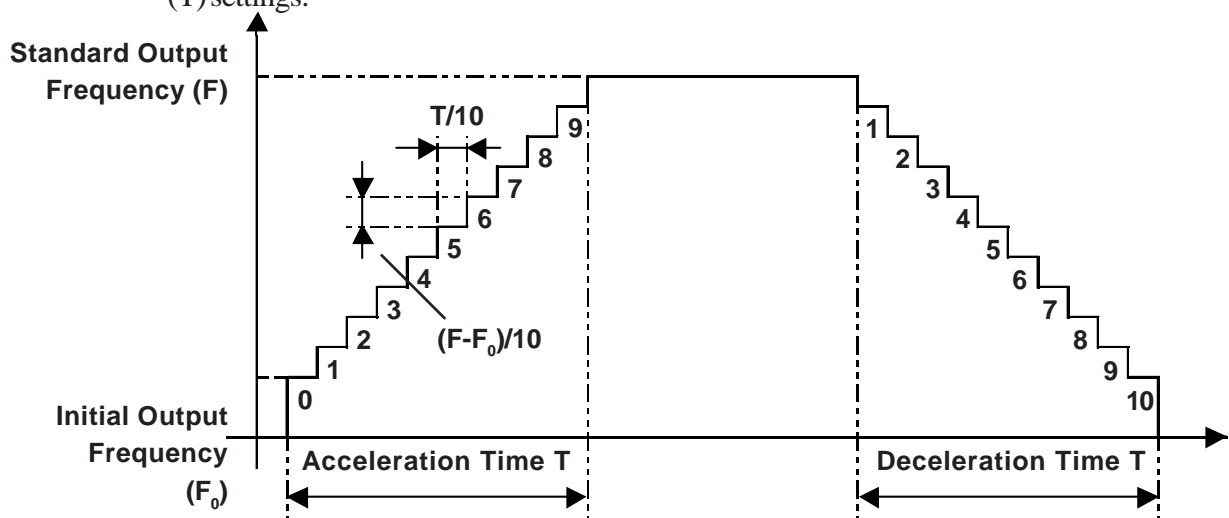



■ **Output Frequency**

Specify the Output Frequency. The available range is between 10Hz and 5kHz. When several groups are used for Pulse Output, the total output frequency must not exceed 5kHz.

Also, while two types of pulses, Normal and Accel/Decel Speed, can be set for a group, the Output Frequency total check will use whichever value is larger, the standard Accel/Decel Speed Pulse Frequency or the Normal Pulse Output's Output Frequency.

**Reference** "2.2.9 Normal Pulse Output"

◆ **Example of Pulse Output Output Frequency Parameter Changes**

Initial Setting		Creating Table		Parameter Change		Actual Frequency After Parameter Change
Group	Frequency (Hz)	Frequency (Hz)		Frequency (Hz)		Frequency (Hz)
1	2000	1500	OK	3000	NG	1500
2	500	500	OK	500	OK	500
3	500	500	OK	500	OK	500
4	500	2000	OK	500	OK	500

When the above parameter changes are made, the following actions occur.

**Initial Settings and then Table Creation**

1. When "1500Hz" is set for Group 1, the total output frequency at this time (3000Hz) is within the allowed maximum of 5000Hz, and therefore the setting of 1500Hz is used and a table is created.

$$1500 + 500 \text{ (Group 2:Initial)} + 500 \text{ (Group 3:Initial)} + 500 \text{ (Group 4:Initial)} = 3000$$

2. When "500Hz" is set for Group 2, the total output frequency at this time (3000Hz) is within the allowed maximum of 5000Hz, and therefore the setting of 500Hz is used and a table is created.

$$1500 \text{ (Group 1:After change)} + 500 + 500 \text{ (Group 3:Initial)} + 500 \text{ (Group 4:Initial)} = 3000$$

3. When "500Hz" is set for Group 3, the total output frequency at this time (3000Hz) is within the allowed maximum of 5000Hz, and therefore the setting of 500Hz is used and a table is created.

$$1500 \text{ (Group 1:After change)} + 500 \text{ (Group 2:After change)} + 500 + 500 \text{ (Group 4:Initial)} = 3000$$

4. When "500Hz" is set for Group 4, the total output frequency at this time (3000Hz) is within the allowed maximum of 5000Hz, and therefore the setting of 500Hz is used and a table is created.

$$1500 \text{ (Group 1:After change)} + 500 \text{ (Group 2:After change)} + 500 \text{ (Group 3:After change)} + 500 = 3000$$

### Table Creation and then Parameter Change

1. When "3000Hz" is set for Group 1, the total output frequency at this time (6000Hz) exceeds the allowed maximum of 5000Hz, and therefore the unit operates at the initial setting of 1500Hz. 3000Hz is not used.

$$3000 + 500 (\text{Group 2:Table value}) + 500 (\text{Group 3:Table value}) + 2000 (\text{Group 4:Table value}) = 6000$$



***The unit operates at 1500Hz, however when the output frequency total check includes Group 1, the initial value of 2000Hz is larger than the table value of 1500Hz and the initial value is used.***

2. When "500Hz" is set for Group 2, the total output frequency at this time (3500Hz) is within the allowed maximum of 5000Hz, and therefore the unit operates at 500Hz.

$$2000 (\text{Group 1:Initial}) + 500 + 500 (\text{Group 3:Table}) + 500 (\text{Group 4:Table value}) = 3500$$

3. When "500Hz" is set for Group 3, the total output frequency at this time (3500Hz) is within the allowed maximum of 5000Hz, and therefore the unit operates at the new setting of 500Hz.

$$2000(\text{Group 1:Initial}) + 500 (\text{Group 2:Table value}) + 500 + 500 (\text{Group 4:Table}) = 3500$$

4. When "500Hz" is set for Group 4, the total output frequency at this time (3500Hz) is within the allowed maximum of 5000Hz, and therefore the unit operates at the new setting of 500Hz.

$$2000(\text{Group 1:Initial}) + 500 (\text{Group 2:Table value}) + 500(\text{Group 3:Table value}) + 500 = 3500$$



- *When a Pulse Output Frequency Total Alarm and a Accel/Decel Speed Pulse Parameter Alarm occur at the same time, due to a change in a group's Output Frequency, the display of the Pulse Output Frequency Total Alarm will be given priority over the Accel/Decel Speed Pulse Parameter Alarm and the Accel/Decel Speed table will not be created.*
- *When a Pulse Output Frequency Total Alarm and an Initial Frequency Value Alarm occur at the same time, due to a change in a group's Output Frequency, the display of the Initial Frequency Value Alarm will be given priority and the Accel/Decel Speed table will not be created.*
- *When the Accel/Decel Speed Pulse Output starts from the OFF state, changing back from ON to OFF will cause 1 output. The timing of the changing from ON to OFF will change the Output Pulse Count, however, when Pulse Output is forced to stop. In order to stop the pulse in any type of condition, the pulse created at the forced stop may not be counted.*
- *When multiple groups turn their Accel/Decel Speed Pulse Table Creation Request ON at the same time, processing is basically performed in first to last order, it may be performed in 3 -> 4 -> 1 -> 2 order to create data from a table in a group that has a Request Flag ON.*

### ■ Initial Output Frequency

Sets the Output Frequency used when Pulse Output starts or stops. Initial Frequency can be set to 0, or from 10Hz to 5kHz. When the Initial Output Frequency is set to "0", if the Accel/Decel Speed time is not "0", the Initial Output Frequency is changed to 10Hz.

### ■ Acceleration/Deceleration Speed Time

This setting is used when the output pulse is changed from Initial Output Frequency to Standard Output Frequency. The time used can be from 0ms to 65535ms.

### ■ Requesting and confirming the creation of a parameter table

Create a parameter table with [Accel/Decel Speed Pulse Table Creation Request]. Also, you can delete this table by setting the initial frequency and the Accel/Decel Speed time values to "0". Then, when the Accel/Decel Speed Pulse table is created, this table is deleted.

◆ **Setting method**

1. Assign variables to [General Item | Accel/DecelSpeedPulseTableCreationRequest] and [General Item | Accel/DecelSpeedPulseTableCreationCompleted] in the [Configure I/O] dialog box.

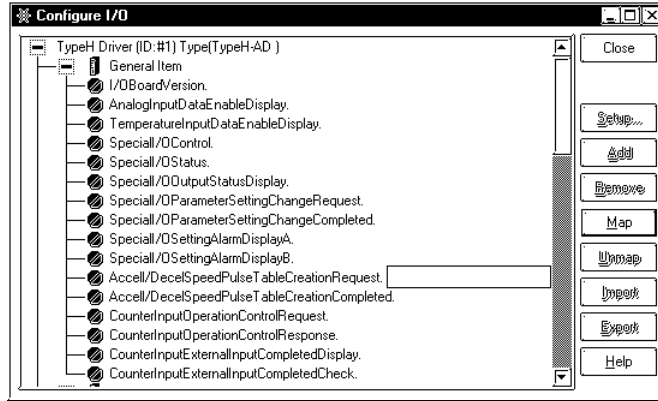

2. The following shows the details of the variable assigned to [General Item | Accel/Decel Speed Pulse Table Creation Request]. The operation bits vary depending on the group to which the pulse output is assigned.

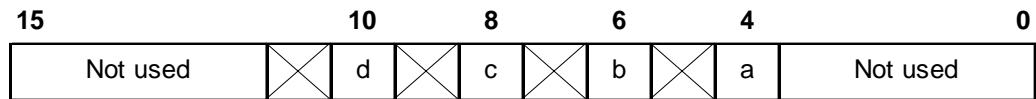

- a: Request for a table for an Acceleration/Deceleration Pulse for group 1 [1]: Request
- b: Request for a table for an Acceleration/Deceleration Pulse for group 2 [1]: Request
- c: Request for a table for an Acceleration/Deceleration Pulse for group 3 [1]: Request
- d: Request for a table for an Acceleration/Deceleration Pulse for group 4 [1]: Request

3. The following shows the details of the variable assigned to [Acceleration/Deceleration Pulse Table Creation Completed]. The monitoring bits vary depending on the group to which the Pulse Output is assigned.

<b>15</b>	<b>10</b>								<b>8</b>	<b>6</b>		<b>4</b>	<b>0</b>
Not used	h	g	f	e	d	c	b	a	Not used				

- a: Completion of the table for an Acceleration/Deceleration Speed Pulse for group 1  
[1]: Table completed
- b: Existence of a table for an Acceleration/Deceleration Speed Pulse for group 1  
[1]: Table exists and can be output. [0]: No table exists. (Table cannot be output.)
- c: Completion of the table for an Acceleration/Deceleration Speed Pulse for group 2  
[1]: Table completed
- d: Existence of a table for an Acceleration/Deceleration Speed Pulse for group 2  
[1]: Table exists and can be output. [0]: No table exists. (Table cannot be output.)
- e: Completion of the table for an Acceleration/Deceleration Speed Pulse for group 3  
[1]: Table completed
- f: Existence of a table for an Acceleration/Deceleration Speed Pulse for group 3  
[1]: Table exists and can be output. [0]: No table exists. (Table cannot be output.)
- g: Completion of the table for an Acceleration/Deceleration Speed Pulse for group 4  
[1]: Table completed
- h: Existence of a table for an Acceleration/Deceleration Speed Pulse for group 4  
[1]: Table exists and can be output. [0]: No table exists. (Table cannot be output.)

4. The following is the timing chart for the flags for the request for and completion of a table for an Acceleration/Deceleration Speed Pulse.

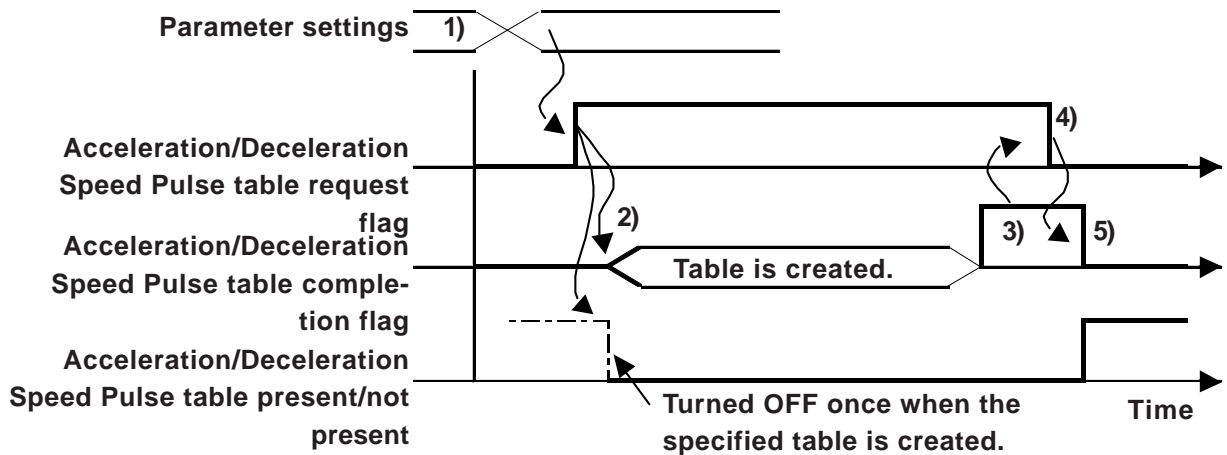

- 1) Set the Output Frequency, Output Pulse, Initial Output Frequency and Accel/Decel Speed Time values.
- 2) When the [Accel/Decel Speed Pulse Table Creation Request] flag is turned ON, a table is created.
- 3) After the table has been created, the completion flag turns ON.
- 4) Confirm that the completion flag turns ON and turn the request flag OFF.
- 5) The completion flag turns OFF after the request flag is recognized as OFF.

◆ **Precautions when creating tables**

If, during Accel/Decel Speed Pulse Output (i.e. the "Accel/Decel Speed Pulse Output Request" bit is ON), the drawing below shows how the [Accel/Decel Speed Pulse Table Creation Request] cannot be received.

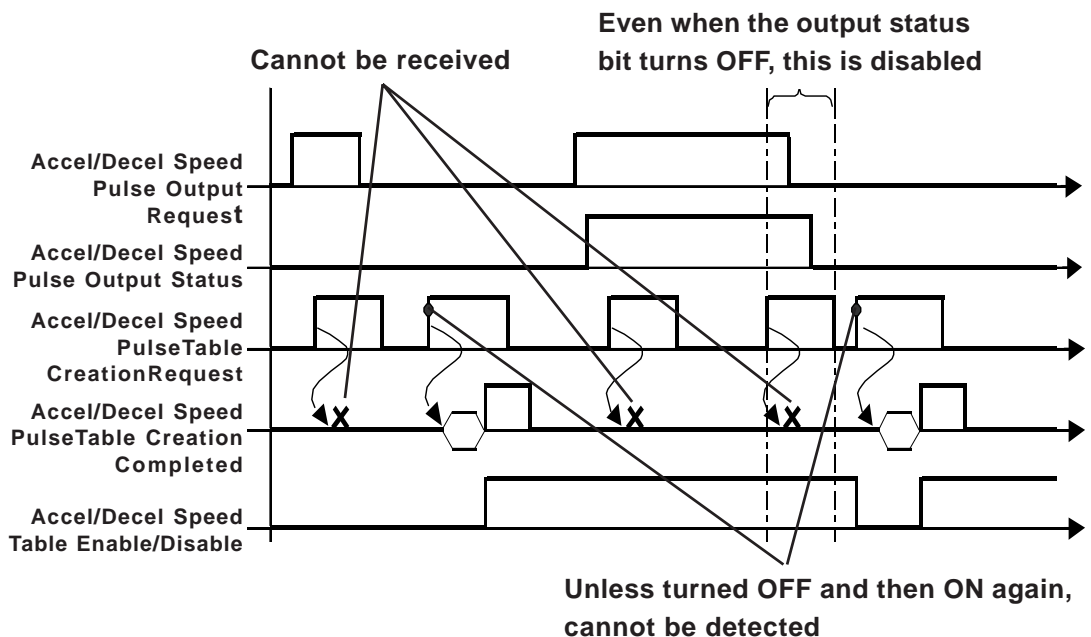

◆ **Controlling Acceleration/Deceleration Speed Pulse Output operation**

The Acceleration/Deceleration Speed Pulse Output is started or stopped. Prior to starting Acceleration/Deceleration Speed Pulse Output, this bit must be enabled (Setting procedure 2) and then started (Setting procedure 3).

◆ **Setting procedure**

1. Assign a variable to [General Item | Special I/O Control] in the [Configure I/O] dialog box.

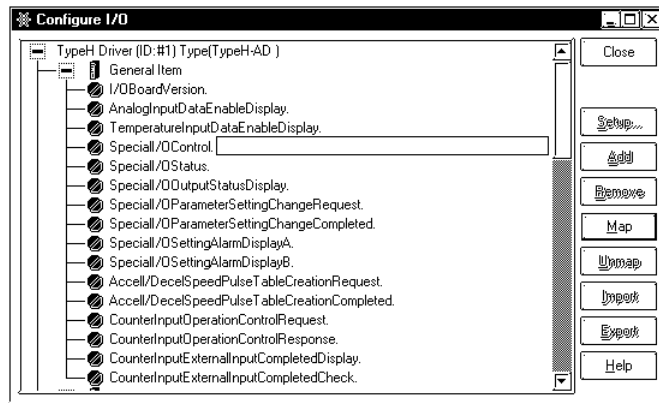

2. The following shows the details of the variable assigned to [Special I/O Control]. The operation bits vary depending on the group to which the counter output is assigned.

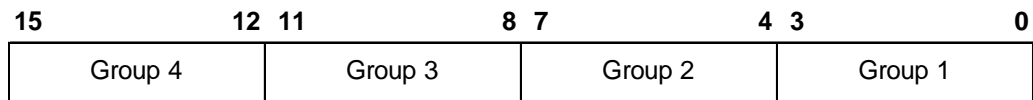

Bit 1 of each group is used for controlling the Acceleration/Deceleration Speed Pulse Output. To start the Acceleration/Deceleration Speed Pulse Output, first turn ON this bit.

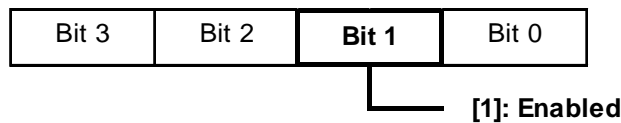

- The operation bits for starting or stopping the pulse output vary depending on the group to which the pulse output is assigned.

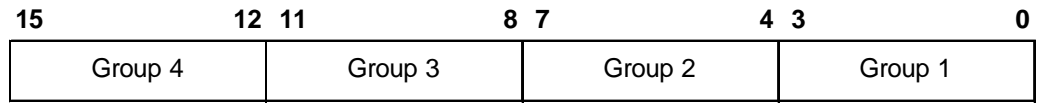

The Acceleration/Deceleration Speed Pulse Output starts when the first bit (bit 0) is turned ON, and stops when the first bit is turned OFF.

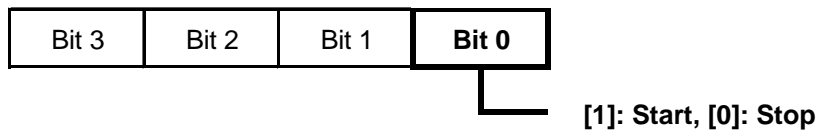

◆ **Pulse Output precautions**

During Accel/Decel Speed Pulse Table Creation, pulses cannot be output.

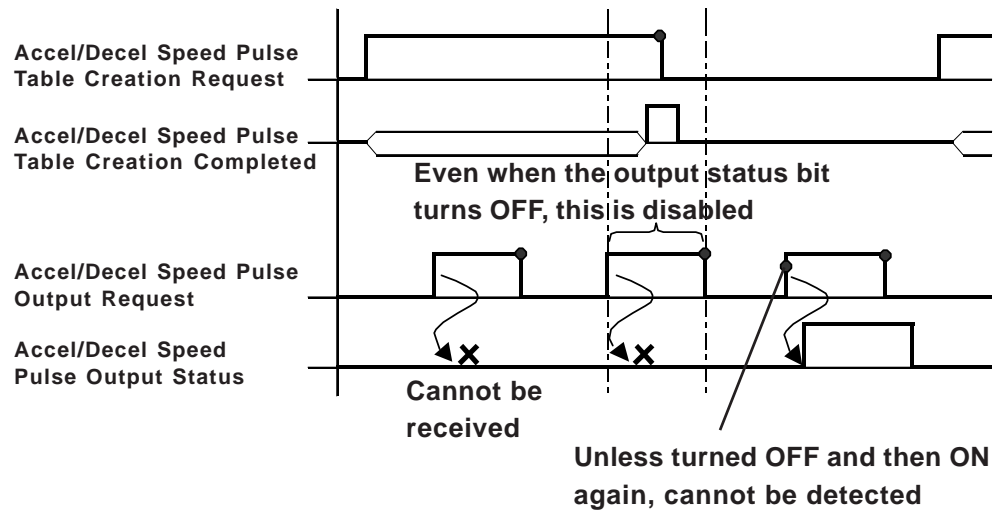

■ **Status of operation and completion of the Acceleration/Deceleration Speed Pulse Output**

You can confirm the operation and completion of the Acceleration/Deceleration Speed Pulse Output.

◆ **Setting procedure**

- Assign a variable to [General Item | Special I/O Status] in the [Configure I/O] dialog box.

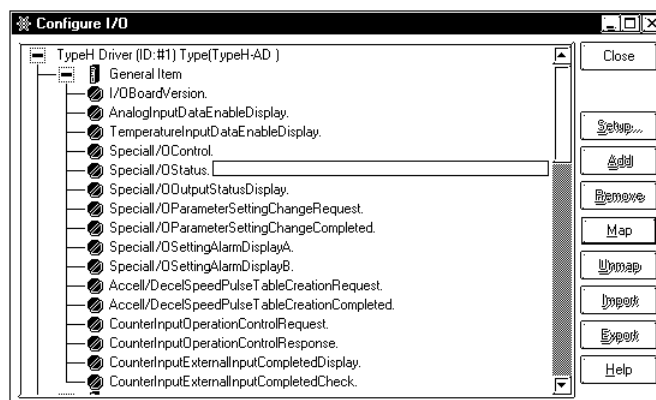



- The following shows the details of the variable assigned to [Special I/O Status]. The monitoring bits vary depending on the group to which the Pulse Output is assigned.

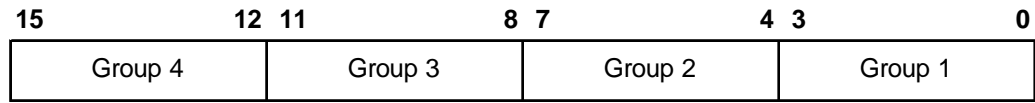

When the first bit (bit 0) of each group is "1", output is enabled. When it is "0", output is disabled.

When bit 2 is "1", the output of the specified number of pulses has been completed.

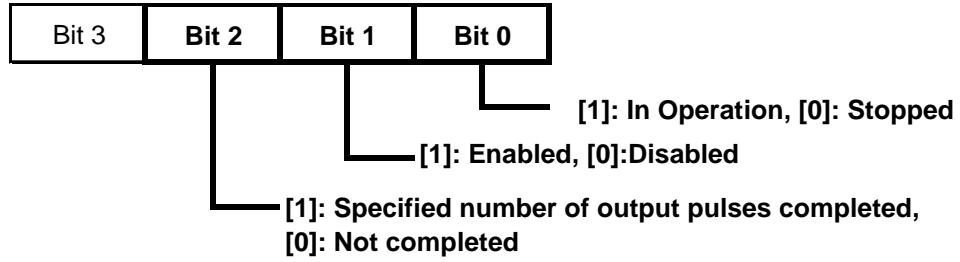

### ■ Acceleration/Deceleration Speed Pulse Output Terminal Status

You can check the pulse output status of output terminals Y0 through Y3.

#### ◆ Setting procedure

- Assign a variable to [General Item | SpecialI/OOutputStatusDisplay] in the [Configure I/O] dialog box.

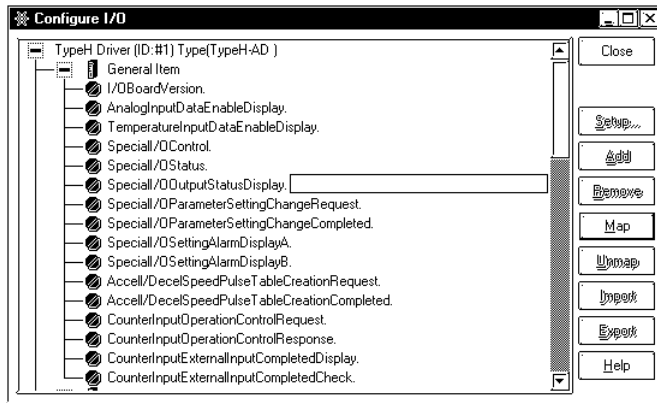

2. The following shows the details of the variable assigned to [Special I/O Output Status Display]. The monitoring bits vary depending on the group to which the pulse output is assigned.

15	12	8	4	0
Not used	d	Not used	c	Not used
			b	Not used
				a

- a: Group 1 Output Status [1]: Output being produced  
[0]: No output
- b: Group 2 Output Status [1]: Output being produced  
[0]: No output
- c: Group 3 Output Status [1]: Output being produced  
[0]: No output
- d: Group 4 Output Status [1]: Output being produced  
[0]: No output

### ■ Acceleration/Deceleration Speed Pulse Output Alarm Status

You can check for Alarm status of the Output Frequency and total Speed Frequency of the Pulse Output.

#### ◆ Setting procedure

1. Assign variables to [General Item | SpecialI/OSettingAlarmDisplayA] and [General Item | SpecialI/OSettingAlarmDisplayB] in the [Configure I/O] dialog box.

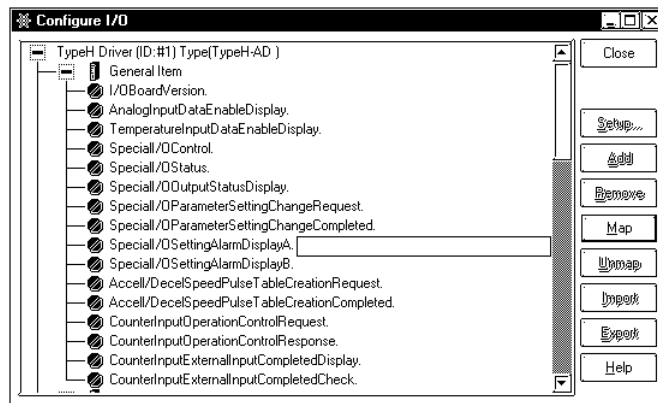

2. The following shows the details of the variables assigned to [Special I/O Setting Alarm Display A ] and [Special I/O Setting Alarm Display B]. The monitoring bits vary depending on the group to which the Pulse Output is assigned.

**Alarm Display A for Special I/O Setting**

15						7	6	5	4	3	2	1	0
e	Not used	d	c	b	a	X	X	X	X	X	X	X	X

- a: Group 1 Pulse Output Frequency Alarm [1]: Exceeds 5kHz  
[0]: Normal
- b: Group 2 Pulse Output Frequency Alarm [1]: Exceeds 5kHz  
[0]: Normal
- c: Group 3 Pulse Output Frequency Alarm [1]: Exceeds 5kHz  
[0]: Normal
- d: Group 4 Pulse Output Frequency Alarm [1]: Exceeds 5kHz  
[0]: Normal
- e: Pulse Output Frequency Total Alarm [1]: Total frequency exceeds 5kHz  
[0]: Normal

**Alarm Display B for Special I/O Setting**

15																0
Not used	h	g	f	e	d	c	b	a	X	X	X	X	X	X	X	X

- a: Group 1 pulse initial frequency output value alarm  
[1]: Initial output frequency is higher than (steady-state) frequency.  
[0]: Normal
- b: Group 2 pulse initial frequency output value alarm  
[1]: Initial output frequency is higher than (steady-state) frequency.  
[0]: Normal
- c: Group 3 pulse initial frequency output value alarm  
[1]: Initial output frequency is higher than (steady-state) frequency.  
[0]: Normal
- d: Group 4 pulse initial frequency output value alarm  
[1]: Initial output frequency is higher than (steady-state) frequency.  
[0]: Normal

- e: Group 1 Accel/Decel Speed Pulse parameter alarm
  - [1]: Initial Output Frequency is same as (steady-state) Frequency, Output Pulse count equals 21, Accel/Decel Speed Time increase/decrease
  - [0]: Normal
- f: Group 2 Accel/Decel Speed Pulse parameter alarm
  - [1]: Initial Output Frequency is same as (steady-state) Frequency, Output Pulse count equals 21, Accel/Decel Speed Time increase/decrease
  - [0]: Normal
- g: Group 3 Accel/Decel Speed Pulse parameter alarm
  - [1]: Initial Output Frequency is same as (steady-state) Frequency, Output Pulse count equals 21, Accel/Decel Speed Time increase/decrease
  - [0]: Normal
- h: Group 4 Accel/Decel Speed Pulse parameter alarm
  - [1]: Initial Output Frequency is same as (steady-state) Frequency, Output Pulse count equals 21, Accel/Decel Speed Time increase/decrease
  - [0]: Normal



***When creating an Accel/Decel Speed Pulse Output table, if the special I/O setting alarm display B's initial frequency alarm and the same group's Output Frequency change cause a special I/O setting alarm A's Output Frequency total alarm, the special I/O setting alarm display A's Output Frequency total alarm will not be detected.***

◆ **About the operation of the Accel/Decel Speed Pulse alarm**

In the following cases, pulse output is not created. (Accel/Decel Speed Pulse table enable flag does not turn ON.)

- 1) When the output terminals are not set for pulse output.
- 2) When the designated group is already producing output pulses.
- 3) When the Standard Frequency exceeds 5kHz\*<sup>1</sup>
- 4) When the Initial or Standard Frequency plus another pulse Output Frequency totally exceeds 5kHz\*<sup>2</sup>
- 5) When the Initial Frequency is higher than the Standard Frequency.

In the following cases, Pulse Output does not follow the parameter settings.

- 1) When the total Output Pulse count is low. (Does not reach 21 - instead of accelerating to the Standard Frequency, will decelerate. Or, during Accel/Decel Speed, the Output Pulse count changes in 1 level increments.)

---

1. The Special I/O setting alarm display area A's Frequency alarm bit turns ON.  
 2. The Special I/O setting alarm display area A's Frequency total alarm bit turns ON.

- 2) When the Accel/Decel Speed setting time is short. (Accel/Decel Speed levels are performed one at a time, which causes the Accel/Decel Speed Time to vary from set time.)\*<sup>1</sup>
- 3) When the Accel/Decel Speed setting time is long. (Accel/Decel Speed levels are performed one at a time, which causes the Accel/Decel Speed Time to vary from set time.)\*<sup>1</sup>

◆ **Accel/Decel Speed Frequency level diagram**

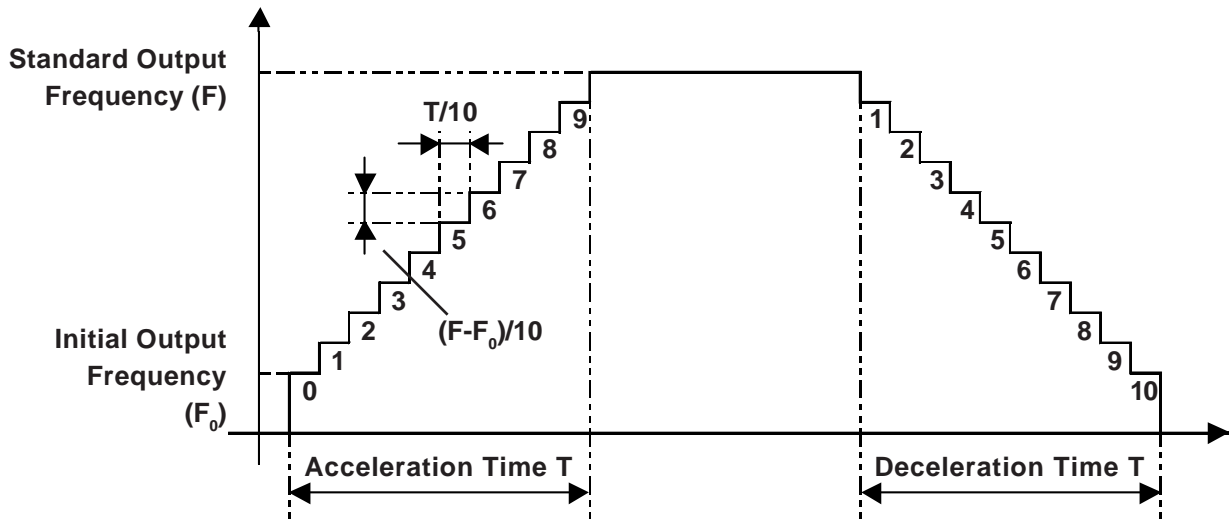

**When requesting each level's frequency**

nth level's frequency = Initial Frequency + (Standard Frequency - Initial Frequency)/10 levels\*(n levels - 1 level)  
 nth level's frequency's decimal point data is discarded.

**When requesting each level's pulse amount**

nth level's pulse amount = (Accel/Decel Speed Time/10 levels)\*(nth level's Frequency/1000ms)  
 nth level's pulse amount's decimal point data is discarded.  
 Since the minimum pulse amount is "1", if the pulse amount is actually "0", it is treated as "1".

The required pulse amount for an Accel/Decel Speed Pulse = (1st level's pulse amount + ....+ 10th level pulse amount)\*2+1 pulse.

This pulse amount, if it becomes larger than the designated pulse output amount, will become the Accel/Decel Speed Pulse parameter alarm's Accel/Decel increase.

**When requesting each level's Accel/Decel Speed Time**

nth level's Accel/Decel Speed Time = nth level's Pulse amount\*(1000ms/nth level's frequency)  
 nth level's Accel/Decel Speed Time's decimal data is discarded.  
 Accel/Decel Speed Time required for Accel/Decel = 1st level's Accel/Decel time + .... + 10th level's Accel/Decel time.  
 This Accel/Decel Speed Time, if it becomes larger than the designated Accel/Decel Speed Time, will become the Accel/Decel Speed Pulse parameter alarm's Accel/Decel Speed decrease.

1. The Special I/O setting alarm display area B's Accel/Decel Speed Pulse parameter alarm bit turns ON. (however, Accel/Decel Speed Pulse enable flag turns ON, and Accel/Decel Speed Pulse Output is possible.)

Ex. Using the previously explained calculation method, an Accel/Decel Speed table is created using the parameters given below. The calculated values are used to determine if a value becomes an alarm value or not.

<b>Output Frequency (Hz)</b>	500
<b>Output Pulse Count (Pulse)</b>	300
<b>Initial Frequency (Hz)</b>	10
<b>Accel/Decel Speed Time (ms)</b>	600

Thus, each level's frequency, pulse amount and Accel/Decel Speed Time will become as follows:

nLevel	Frequency	Pulse Amount	Accel/Decel Speed Time
1	10	1	100
2	59	3	50
3	108	6	55
4	157	9	57
5	206	12	58
6	255	15	58
7	304	18	59
8	353	21	59
9	402	24	59
10	451	27	59

**Output Pulse Total**

Calculating the total of each level's Output Pulses,  $(1 + 3 + 6 + \dots + 27) \times 2 + 1 = 273$ . Since this is less than the set Output Pulse Count, the [Accel/Decel Speed increase] alarm is cleared.

**Accel/Decel Time Total**

Calculating the total of each level's Accel/Decel Speed Time,  $100 + 50 + 50 + \dots + 59 = 614$ . Since this is more than the set Accel/Decel Speed Time, the [Accel/Decel Speed decrease] alarm is triggered.

### 2.2.11 Analog Input

The controller reads analog signals by monitoring terminals at a rate of 1ch/2ms, converting them into 12-bit digital signals and writing them to I/F RAM. These I/F RAM values are read by the LT once each scan.

#### ■ Analog Input Filter

Every 2 ms, this filter averages the current and preceding values to the extent specified with the [Analog Input] dialog box.

The available setting range is 0 to 64, and when this value is set to "0", data is used exactly as it is read out. Also, While the read-in analog data is less than the set sampling number, the analog input data enable display flag is OFF and the analog input value is "0".

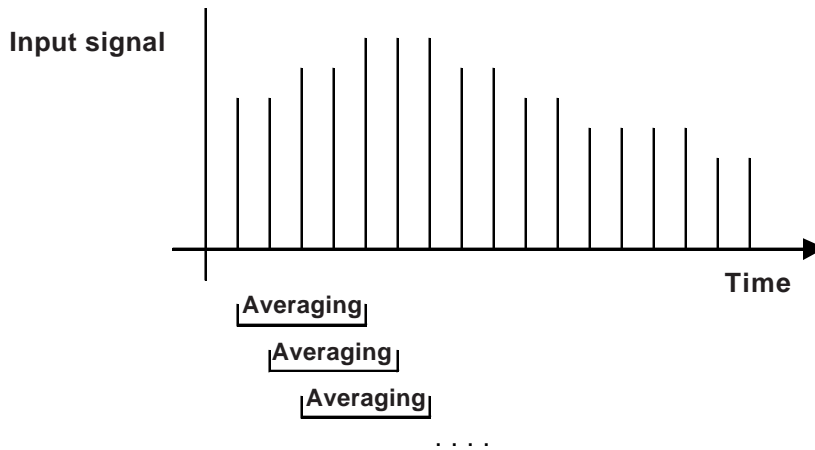

*The number specified for the analog input filter is common to all channels.*

#### ■ Setting procedure

1. Double-click [AnalogInput] in the [Configure I/O] dialog box, or select [Analog Input] and click the [Setup] button.

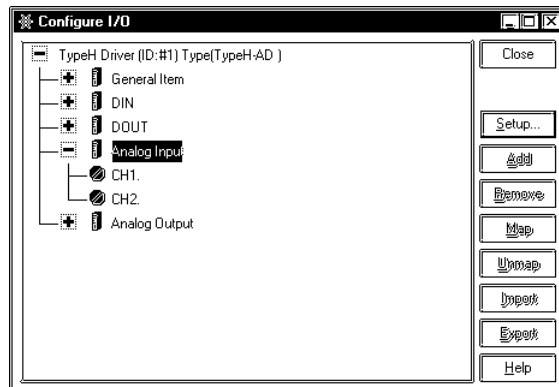

2. The [Analog Input Setting] dialog box appears.

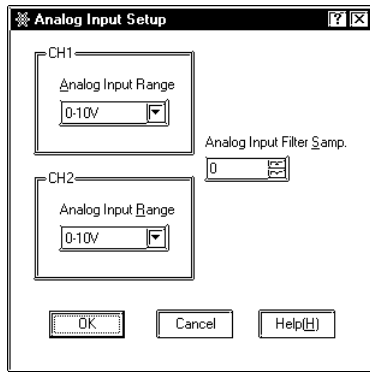

**Note:** When the Analog Input Filter is set to "0", the filter is disabled.

◆ **Analog Input Range and Displayed Value**

The Analog Input Values are displayed within the range of 12-bit values as shown below.

**Displayed value**

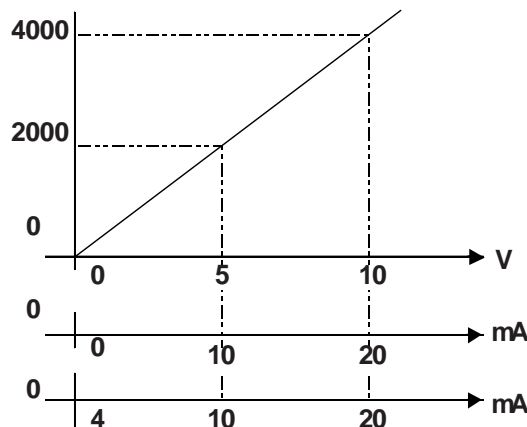

The following table shows the analog value(s) displayed based on the voltage or current input setting.

Analog Input Range	Input Value	Displayed Value (Decimal)
0 to 10 (V)	0 to 10.2375 (V)	0 to 4095
0 to 20 (mA)	0 to 20.475 (mA)	0 to 4095
4 to 20 (mA)	0 to 20.380 (mA)	-1000 to 4095



- Depending on the Type H driver used, 4 to 20mA is converted to 0 to 20mA. The conversion formula is as follows.  
(Depending on the Type H driver used)  
$$a - (b - 800) \times 1.25$$
  - a: Conversion value (the Input Display Value is rounded.)
  - b: Value from the I/O board (0 to 20mA).
- When the Input Range is set from 4 to 20mA, the value used for display when the input is less than 4mA (0 to less than 4) will be displayed a minus value. Use the cable cut detection feature for this minus display range.



■ **Data acquisition status when the Analog Input Filter is used**

You can verify that the amount of Analog Input Data specified is obtained by the Analog Input Filter.

◆ **Setting procedure**

1. Assign a variable to [General Item | AnalogInputDataEnableDisplay] in the [Configure I/O] dialog box.

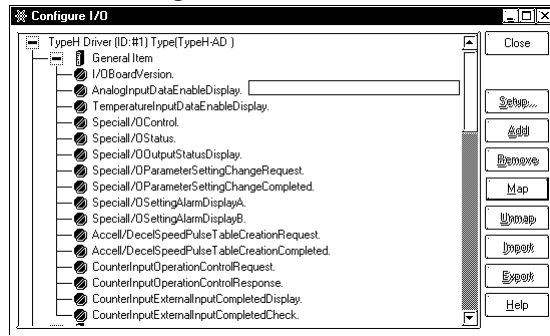

2. The following shows the details of the variable assigned to [Analog Input Data Enable Display]. The status bits vary depending on the channel.

<b>15</b>	<b>2</b>	<b>1</b>	<b>0</b>
Not used		b	a

a: Analog Input Data (CH1)

[0]: Invalid data (obtained during sampling)

[1]: Valid data

b: Analog Input Data (CH2)

[0]: Invalid data (obtained during sampling)

[1]: Valid data

## 2.2.12 Analog Output

Output data is written to I/F RAM from the TypeH driver every LT unit scan time. Next, every 2ms values are read from I/F RAM by the I/O board and reflected to the I/O board's analog output terminal. When the logic program is stopped, the output status of the analog output can be retained.

### ■ Output Hold at Controller Stop

When the logic program is stopped, the output status of the Analog Output is retained. When the logic program is restarted, the operation starts from the retained status.

Going OFFLINE, resetting the LT, or turning its power OFF however, initializes the I/O terminals. As a result, all the retained output statuses are turned OFF.

### ■ Setting procedure

1. Double-click [AnalogOutput] in the [Configure I/O] dialog box, or select [AnalogOutput] and click the [Setup] button.

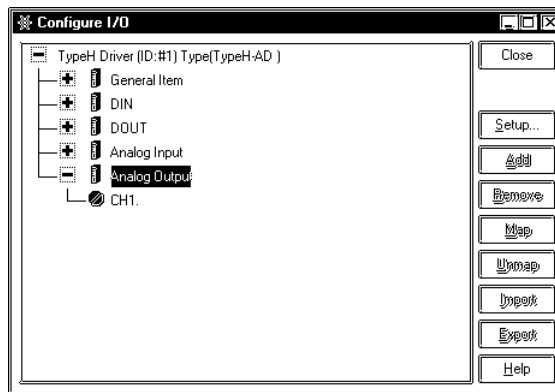

2. The [Analog Output Setting] dialog box appears.

The dialog box may differ between Type H-AD and Type H-ADP/Type H-ADT due to the differing number of channels. See the appropriate screen for the type you are using.

**Type H-AD**

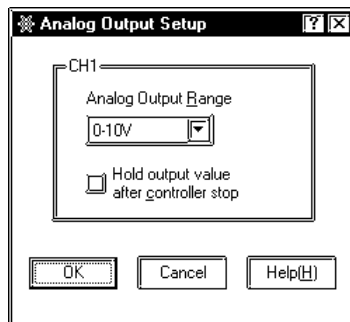

**Type H-ADP/Type H-ADT**

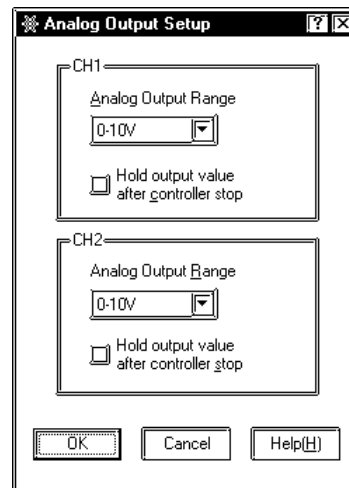

3. When the controller stops, the output hold and the analog output range are set.

**Reference** *For information about the Analog Output Range, see the following “Analog Output Range and display” section.*

**◆ Analog Output Range and Displayed Values**

The Analog Output Values are displayed within the range of 12-bit values as shown below.

**Displayed value**

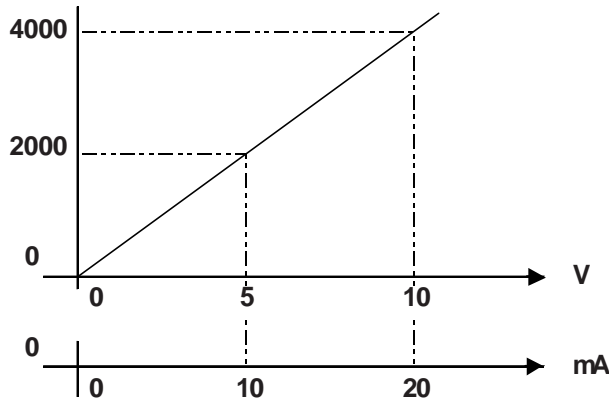

The following table shows the analog values displayed with the voltage or current input setting.

Analog Input Range	Input Value	Displayed Value (Decimal)
0 to 10 (V)	0 to 10.2375 (V)	0 to 4095
0 to 20 (mA)	0 to 20.475 (mA)	0 to 4095

### 2.2.13 Thermocouple Input

The controller reads analog signals from the thermocouple input by converting them into temperature data.

The I/O board reads thermocouple input (every 2ms) from each Channel and from the circuit board's temperature. Temperature data is stored in each channel's internal buffer. When the AD values (analog temperature data converted to digital) reach 21, those values are averaged and the single resulting value is written to I/F RAM. This value is then read out once every LT scan.

To avoid noise-induced fluctuations of thermocouple input signals, the thermocouple input filter can be used to average input signals.

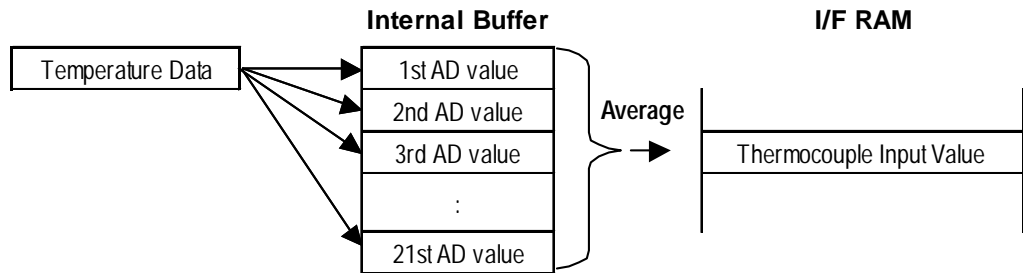

#### ■ Thermocouple Input Filter

Input signal (AD) values are collected every 2ms and stored in each channel's internal buffer. When the number of AD values collected in these internal channel buffers equals 21, the data is averaged automatically and stored in Internal Buffer 2. Then, according to the value set in the [Thermocouple Input Settings] dialog box, averaging is performed a second time when the number of averaged data values in Buffer 2 reaches this setting value (Example below uses "64"). This second averaged value is then written to I/F RAM, and is read out once every LT scan.

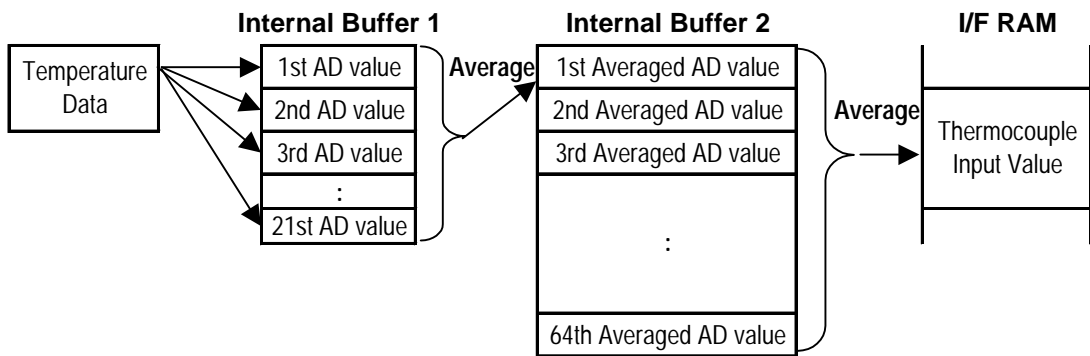

- **The thermocouple input filter's frequency and input range settings are used for all channels.**
- **Until an averaged AD value is stored, in order for  $2ms \times [Ch\ No. (H4:2, H5:3) + 1 (board\ temperature)] \times 21(ms)$  to elapse, if the filter frequency is increased, LT unit power ON or Reset, and also if the temperature returns to the normal specification range from outside of the normal specification range, time will be required for the new temperature data to be enabled.**

**Ex. Using a Type H-ADT with a filter frequency setting of 64:**

$$2 \times 4 \times 21 \times 64 = 10.752(ms) \text{ Ave. } 10.8sec.$$

### ■ Setting procedure

1. Double-click [Thermocouple Input] in the [Configure I/O] dialog box, or select [Thermocouple Input] and click the [Setup] button.

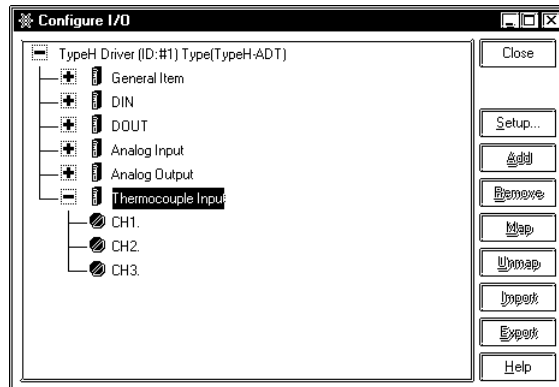

2. The [Thermocouple Input Setting] dialog box appears. This sets the thermocouple input range and the thermocouple filter amount (0 to 64). For thermocouple input range details, see [Reference](#) ◆ *Thermocouple Input Range*.

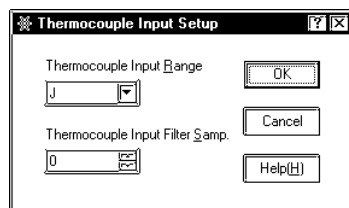

**Note:** When the Thermocouple Input Filter is set to "0", the filter is disabled.

### ◆ Thermocouple Input Range

Select the type of thermocouple to be connected, either type J or type K.

◆ Thermocouple Input Value and Displayed Value

Type J

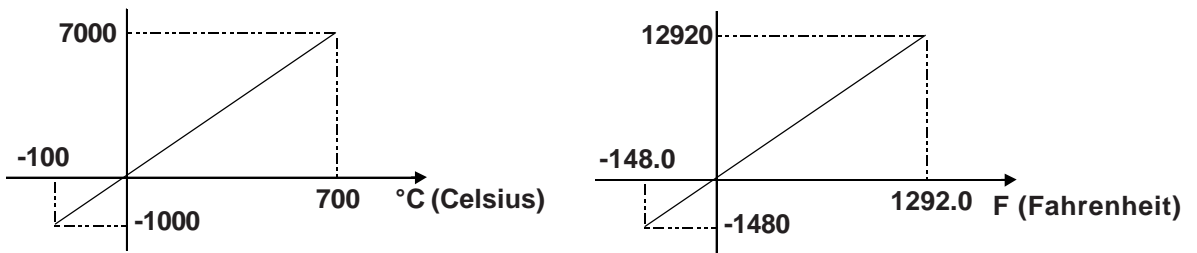

The following table is a summary of the range above.

	Celsius		Fahrenheit	
	Displayed Value(decimal)	Input Value C	Displayed Value(decimal)	Input Value F
<b>Out of specified temperature range (+)</b>	32767	710.1 or higher	32767	1310.1 or higher
<b>Within specified temperature range</b>	-1000 to 7000	100.0 to 700.0	-1480 to 12920	-148.0 to 1292.0
<b>Out of specified temperature range (-)</b>	-32768	-110.1 or lower	-32768	-166.1 or lower



**Note:** The temperature can be switched between Celsius and Fahrenheit modes in the [General Item Setup] dialog box

Type K

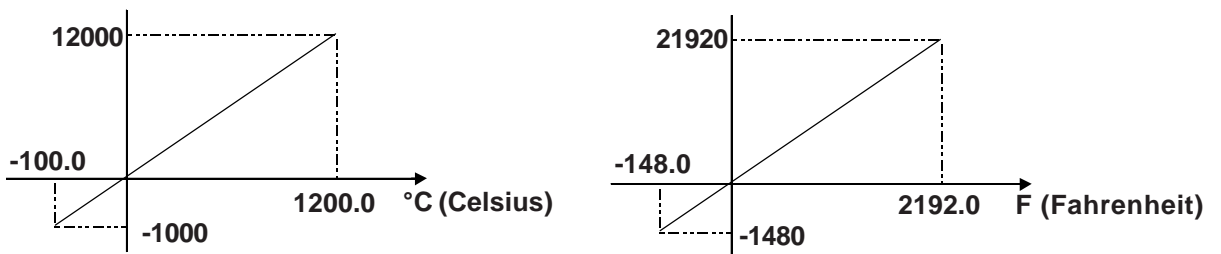

The following table is a summary of the range above.

	Celsius		Fahrenheit	
	Displayed Value(decimal)	Input Value C	Displayed Value(decimal)	Input Value F
<b>Out of specified temperature range (+)</b>	32767	1210.1 or higher	32767	2210.1 or higher
<b>Within specified temperature range</b>	-1000 to 12000	-100.0 to 1200.0	-1480 to 21920	-148.0 to 2192.0
<b>Out of specified temperature range (-)</b>	-32768	-110.1 or lower	-32768	-166.1 or lower



**Note:** The temperature can be switched between Celsius and Fahrenheit modes in the [General Item Setup] dialog box.

◆ **Temperature Input Outside of Specification Range**

When the temperature values input exceed the specified range by more than 10°C(+/-), all sampled data collected up to that point is cleared. Then, when the input temperature falls back to within the specified range, sampling will restart. At this time, until the sampling amount reaches the set value, the display will read "32767" or "-32768".

Ex. J type (°C display)

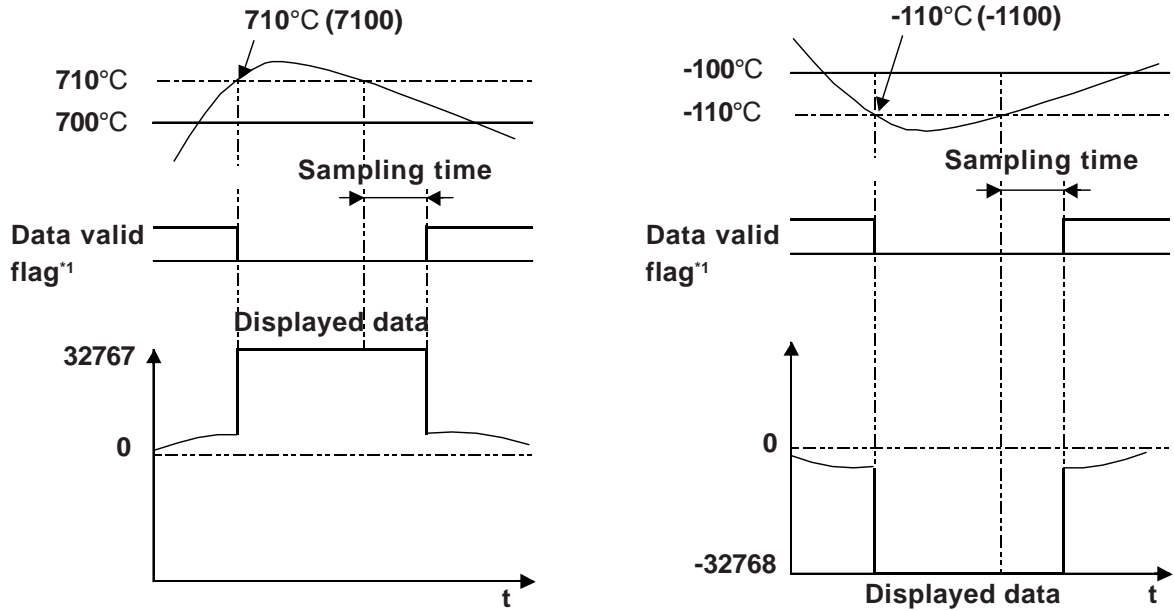

1. Temperature input data valid display's data valid flag.

## ■ Data acquisition status when the Thermocouple Input Filter is used

You can determine whether the amount of thermocouple input data obtained is as specified for the Thermocouple Input Filter.

### ◆ Setting procedure

1. Assign a variable to [General Item | TemperatureInputDataEnableDisplay] in the [Configure I/O] dialog box.

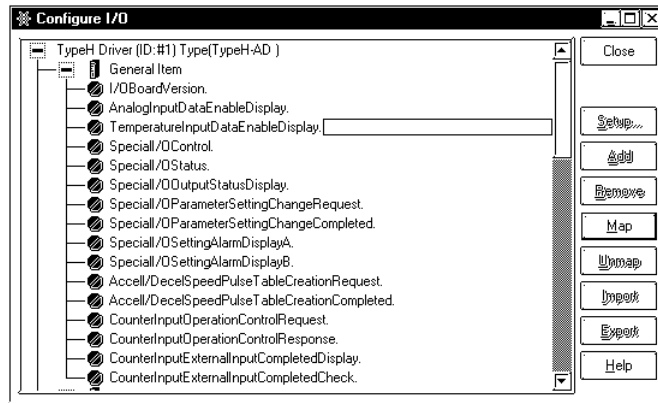

2. The following shows the details of the variable assigned to [Temperature Input Data Enable Display]. The status bits vary depending on the channel.

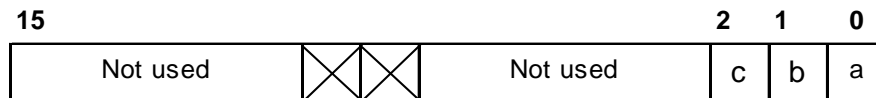

- |   |  |
|---|--|
| <p>a: Thermocouple Input Data (CH1)</p> <p>b: Thermocouple Input Data (CH2)</p> <p>c: Thermocouple Input Data (CH3)</p> | <p>[0]: Invalid data (obtained during sampling)</p> <p>[1]: Valid data</p> <p>[0]: Invalid data (obtained during sampling)</p> <p>[1]: Valid data</p> <p>[0]: Invalid data (obtained during sampling)</p> <p>[1]: Valid data</p> |
|---|--|



2.2.14 Pt100 Input

The controller reads analog signals from the Pt100 Input by converting them into temperature data.

The I/O board reads Pt100 Input (every 2ms) from each Channel and from the circuit board's temperature. Temperature data is stored in each channel's internal buffer.

When the AD values (analog temperature data converted to digital) reach 21, those values are averaged and the single resulting value is written to I/F RAM. This value is then read out once every LT scan.

The controller reads the analog signals of the Pt100 Input by converting them into temperature data. To avoid noise-induced fluctuations in Pt100 Input signals, the Pt100 Input Filter can be used to average the input signals.

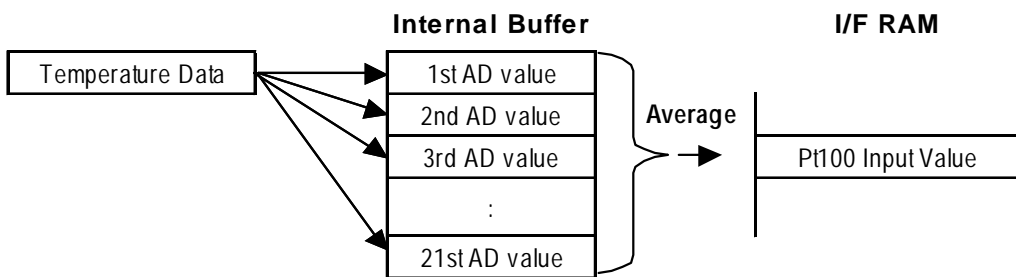

■ Pt100 Input Filter

Every 2 ms, this filter averages the current and preceding values according to the number specified with the [Pt100 Input Setup] dialog box.

Input signal (AD) values are collected every 2ms and stored in each channel's internal buffer. When the number of AD values collected in these internal channel buffers equals 21, the data is averaged automatically and stored in Internal Buffer 2. Then, according to the value set in the [Pt100 Input Setup] dialog box, averaging is performed a second time when the number of averaged data values in Buffer 2 reaches this setting value (Example below uses "64"). This second averaged value is then written to I/F RAM, and is read out once every LT scan.

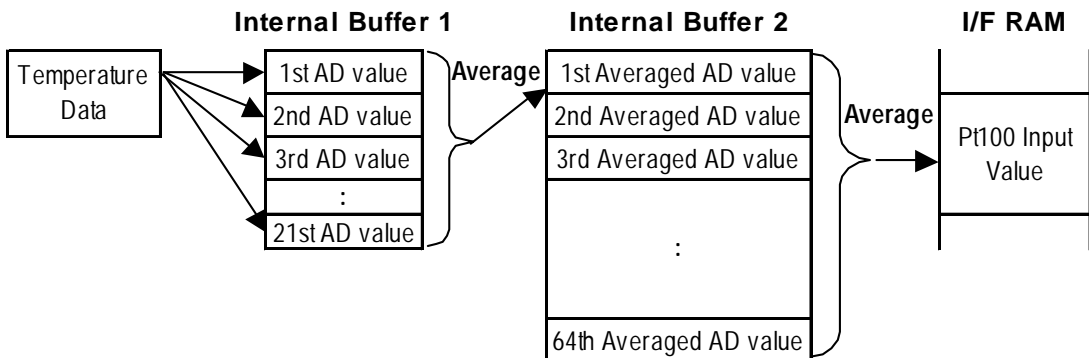



- The number specified for the Pt100 Input filter and the range specified for Pt100 Input are common to all channels.
- When the filter frequency becomes large, temperature reading data (When the power is turned ON or reset, or when the temperature returns to within the specified range from outside the range) may require over 5 seconds to become effective. The time required until an averaged AD value is stored ( $2\text{ms} \times \text{No. of channels} \times 21\text{ms}$ ) is as follows:

Assuming Pt100 Input filter frequency is set to 64 (with Type H-ADP)  
 $2 \times 2 \times 21 \times 64 = 5,376(\text{ms})$  [Approx. 5.4 sec.]

## ■ Setting procedure

1. Double-click [Pt100 Input] in the [Configure I/O] dialog box, or select [Pt100 Input] and click the [Setup] button.

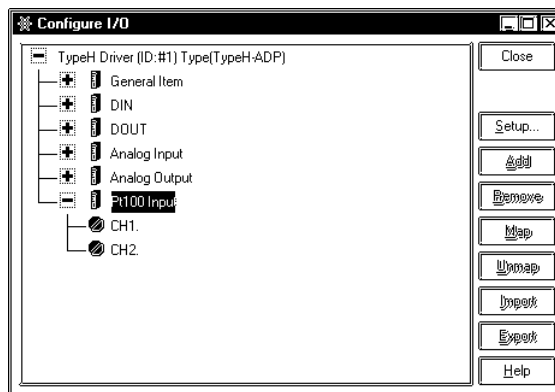

2. The [Pt100 Input Setup] dialog box appears. Here, enter the number of Input Filter Samples (0 to 64) used.

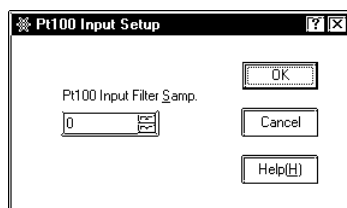

When the Pt100 Input Filter is set to "0", the filter is disabled.

◆ Pt100 Input Value and Displayed Value

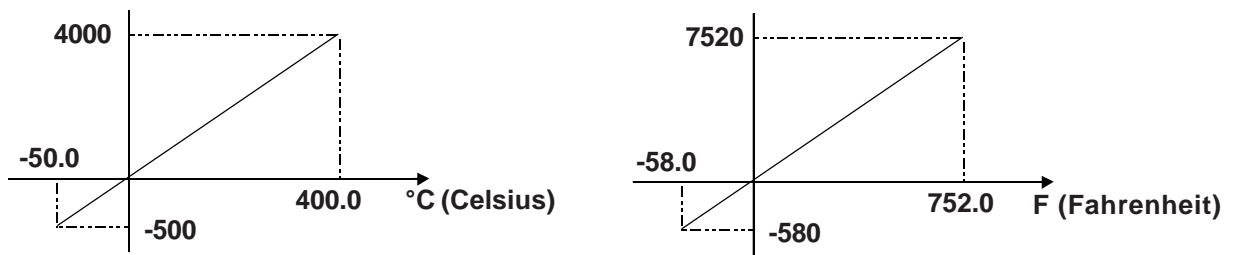

The following table is a summary of the range above.

	Celsius		Fahrenheit	
	Displayed Value(decimal)	Input Value C	Displayed Value(decimal)	Input Value F
<b>Out of specified temperature range (+)</b>	32767	410.1 or higher	32767	770.1 or higher
<b>Within specified temperature range</b>	-500 to 4000	50.0 to 400.0	-580 to 7520	-58.0 to 752.0
<b>Out of specified temperature range (-)</b>	-32768	-60.1 or lower	-32768	-76.1 or lower



**Note:** The temperature can be switched between Celsius and Fahrenheit modes in the [General Item Setting] dialog box.

◆ Temperature Input outside of Specification Range

When the temperature values input exceed the specified range by more than 10°C(+/-), all sampled data collected up to that point is cleared. Then, when the input temperature falls back to within the specified range, sampling will restart. At this time, until the sampling amount reaches the set value, the display will read "32767" or "-32768".

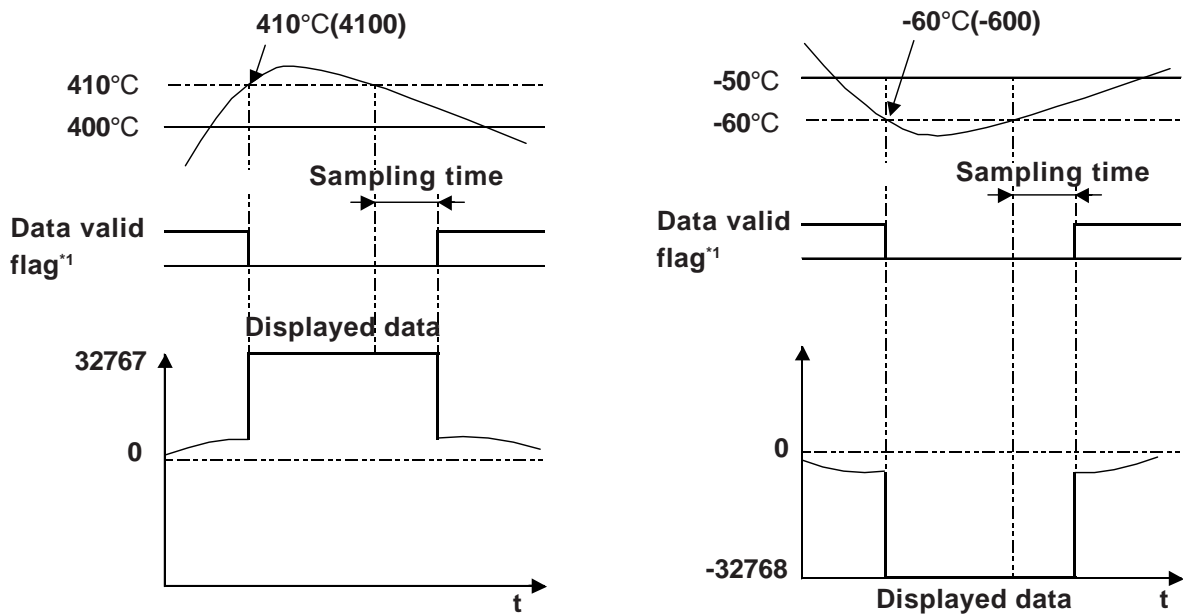

1. Temperature input data valid display's data valid flag.

■ **Data acquisition status when the Pt100 Input Filter is used**

You can determine whether the number of Pt100 Input Data obtained is as specified for the Pt100 Input Filter.

◆ **Setting procedure**

1. Assign a variable to [General Item | TemperatureInputDataEnableDisplay] in the [Configure I/O] dialog box.

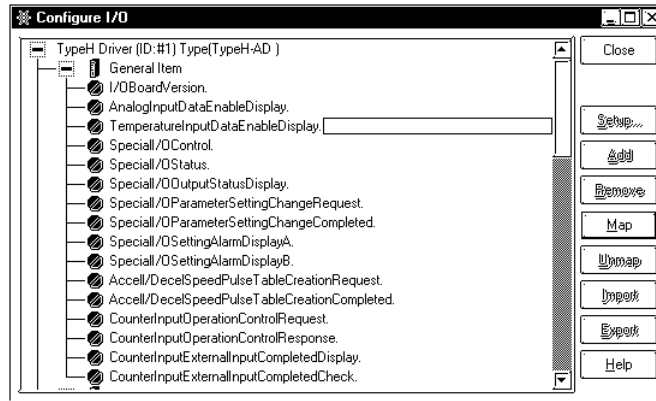

2. The following shows the details of the variable assigned to [Temperature Input Data Enable Display]. The status bits vary depending on the channel.

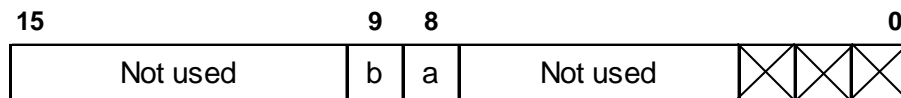

a: Pt100 Input Data (CH1)

[0]: Invalid data (obtained during sampling)

[1]: Valid data

b: Pt100 Input Data (CH2)

[0]: Invalid data (obtained during sampling)

[1]: Valid data

# *Memo*

# Chapter

## 3 Error Messages

All I/O errors noted here are I/O read or write errors. When an error occurs, that error's code is written to the controller's #IOStatus [1] variable.

Setting errors are checked when the logic program is downloaded to the LT unit. When a setting error is detected, the logic program stops. However, Initialization, Runtime or Internal errors will not cause the logic program to stop. This section explains the meaning of each error and that error's possible solution.



**If an I/O error occurs and the controller stops, please create the following logic program. However, please understand that 1 scan will be required from when the error is detected to when the logic program stops.**

**In the following example, #IOFault detects the I/O error, 1 is entered to #Command and the logic program stops.**



**When an error exists in I/O, #IOFault will turn ON. For error details, check #IOStatus [1].**

### ◆ Setting Errors

<b>Error #</b>	<b>Problem</b>	<b>Countermeasure</b>
<b>Error 500</b>	An unsupported driver has been detected.	
<b>Error 501</b>	An internal-type variable has been assigned as the variable for an I/O terminal.	Change the variable type to input or output.
<b>Error 502</b>	An input-type variable has been assigned as the variable for an output terminal.	Change the variable type to output.
<b>Error 503</b>	An output-type variable has been assigned as the variable for an input terminal.	Change the variable type to input.
<b>Error 504</b>	A discrete-type variable has been assigned as the variable for an integer terminal.	Change the variable type to integer.
<b>Error 505</b>	An integer-type variable has been assigned as the variable for a discrete terminal.	Change the variable type to discrete.
<b>Error 506</b>	Variable types not supported by the driver have been assigned as variables for the terminals.	Change the variable types.
<b>Error 507</b>	No variables have been assigned to the terminals.	Allocate variables to all terminals.
<b>Error 508</b>	A hardware type not supported by the driver has been specified.	Change the LT type.
<b>Error 801</b>	Some terminal numbers may overlap due to file corruption.	Not supported by the current driver.

◆ Initialization Errors

Error #	Problem	Countermeasure
<b>Error 821</b>	The actual LT type and the LT type setting differ.	Check that the LT type agrees with the current unit.
<b>Error 822</b>	I/O Board Initialization Alarm.	LT may be damaged. Contact your local LT service center about this error code.
<b>Error 823</b>	I/O Board System ROM Alarm.	LT may be damaged. Contact your local LT service center about this error code.
<b>Error 824</b>	I/O Board System RAM Alarm.	LT may be damaged. Contact your local LT service center about this error code.
<b>Error 825</b>	I/O Board Microprocessor Alarm.	LT may be damaged. Contact your local LT service center about this error code.
<b>Error 826</b>	I/O Board Interface RAM Alarm.	LT may be damaged. Contact your local LT service center about this error code.
<b>Error 827</b>	I/O Board E2PROM Alarm.	LT may be damaged. Contact your local LT service center about this error code.

◆ Runtime Errors

Error #	Problem	Countermeasure
<b>Error 841</b>	I/O Board Alarm.	LT may be damaged. Contact your local LT service center about this error code.
<b>Error 842</b>	Special I/O Setting Parameter Alarm.	Refer to the Special Parameter Setting Alarm Display A or B, and re-enter the current settings.

◆ Internal Errors

Error #	Problem	Countermeasure
<b>Errors 850 to 853</b>	Driver errors. A major system error has occurred.	Reset the LT unit. If the error code persists, the problem may be either a connected peripheral device or the LT unit itself. If LT is damaged, contact your local LT service center about this error code.



# *Memo*