

Saia S-Bus SIO Driver

1	System Configuration.....	3
2	Selection of External Device	11
3	Example of Communication Setting.....	12
4	Setup Items.....	22
5	Cable Diagram	27
6	Supported Device.....	39
7	Device Code and Address Code.....	48
8	Error Messages.....	49

Introduction

This manual describes how to connect the Display and the External Device (target PLC).

In this manual, the connection procedure will be described by following the below sections:

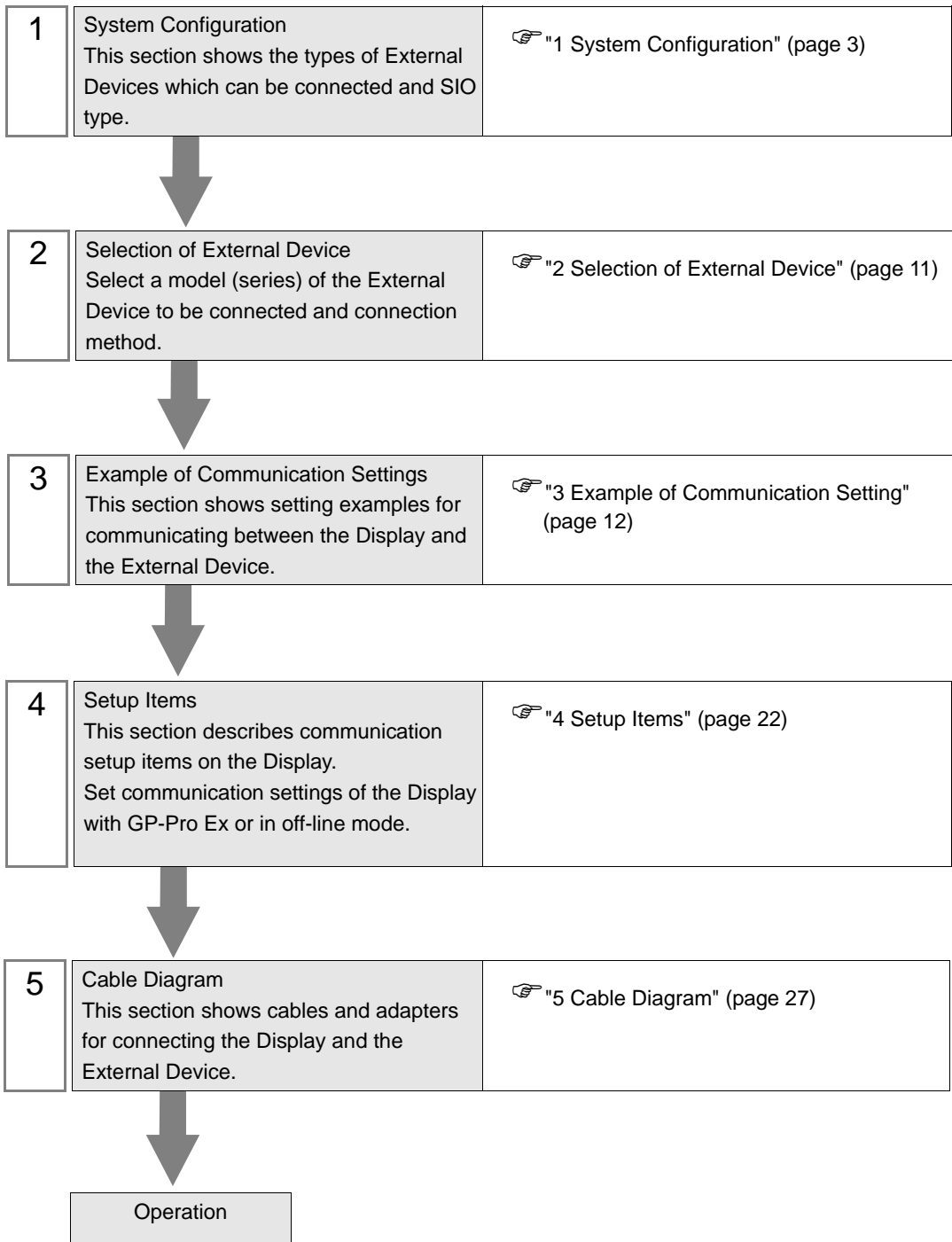

1 System Configuration

The system configuration in the case when the External Device of Saia-Burgess Controls Ltd. and the Display are connected is shown.

Series	CPU	Link I/F	SIO Type	Setting Example	Cable Diagram
PCD	PCD1.M110	PGU (Port 0)	RS232C	Setting Example 1 (page 12)	Cable Diagram 1 (page 27)
		PORT1	RS422/485 (2 wire)	Setting Example 4 (page 18)	Cable Diagram 4 (page 30)
	PCD1.M120 PCD1.M130	PGU	RS232C	Setting Example 1 (page 12)	Cable Diagram 1 (page 27)
		PCD7.F110	RS422/485 (2 wire)	Setting Example 4 (page 18)	Cable Diagram 4 (page 30)
			RS422/485 (4 wire)	Setting Example 5 (page 20)	Cable Diagram 5 (page 32)
		PCD7.F120	RS232C	Setting Example 2 (page 14)	Cable Diagram 2 (page 28)
		PCD7.F150	RS422/485 (2 wire)	Setting Example 4 (page 18)	Cable Diagram 4 (page 30)

Series	CPU	Link I/F	SIO Type	Setting Example	Cable Diagram
PCD	PCD2.M110 PCD2.M120 PCD2.M150 PCD2.M170 PCD2.M480	PGU (Port 0)	RS232C	Setting Example 1 (page 12)	Cable Diagram 1 (page 27)
			RS422/485 (2 wire)	Setting Example 3 (page 16)	Cable Diagram 4 (page 30)
		PCD7.F110	RS422/485 (2 wire)	Setting Example 4 (page 18)	Cable Diagram 4 (page 30)
			RS422/485 (4 wire)	Setting Example 5 (page 20)	Cable Diagram 5 (page 32)
		PCD7.F120	RS232C	Setting Example 2 (page 14)	Cable Diagram 2 (page 28)
		PCD7.F150	RS422/485 (2 wire)	Setting Example 4 (page 18)	Cable Diagram 4 (page 30)
	PCD2.M120 PCD2.M150 PCD2.M170 PCD2.M480	PCD2.F520	RS232C	Setting Example 2 (page 14)	Cable Diagram 3 (page 29)
			RS422/485 (2 wire)	Setting Example 4 (page 18)	Cable Diagram 4 (page 30)
			RS422/485 (4 wire)	Setting Example 5 (page 20)	Cable Diagram 6 (page 36)
		PCD2.F522	RS232C	Setting Example 2 (page 14)	Cable Diagram 3 (page 29)
	PCD2.M480	Port 6	RS422/485 (2 wire)	Setting Example 4 (page 18)	Cable Diagram 4 (page 30)

Series	CPU	Link I/F		SIO Type	Setting Example	Cable Diagram		
PCD	PCD3.M3020 PCD3.M3230 PCD3.M3330 PCD3.M5440 PCD3.M5540	PCD3.F110		RS422/485 (2 wire)	Setting Example 4 (page 18)	Cable Diagram 4 (page 30)		
				RS422/485 (4 wire)	Setting Example 5 (page 20)	Cable Diagram 5 (page 32)		
		PCD3.F150		RS422/485 (2 wire)	Setting Example 4 (page 18)	Cable Diagram 4 (page 30)		
		PCD3.F121		RS232C	Setting Example 2 (page 14)	Cable Diagram 2 (page 28)		
		Port 2		RS422/485 (2 wire)	Setting Example 4 (page 18)	Cable Diagram 4 (page 30)		
	PCD3.M5440 PCD3.M5540	PGU (Port 0)		RS232C	Setting Example 1 (page 12)	Cable Diagram 1 (page 27)		
	PCD4.M110 PCD4.M125 PCD4.M145 PCD4.M170 PCD4.M445	PGU		RS232C	Setting Example 1 (page 12)	Cable Diagram 1 (page 27)		
	PCD4.M125 PCD4.M145 PCD4.M170 PCD4.M445	PCD4.C340		PCD7.F110		RS422/485 (2 wire)	Setting Example 4 (page 18)	Cable Diagram 4 (page 30)
						RS422/485 (4 wire)	Setting Example 5 (page 20)	Cable Diagram 5 (page 32)
				PCD7.F120		RS232C	Setting Example 2 (page 14)	Cable Diagram 2 (page 28)
				PCD7.F150		RS422/485 (2 wire)	Setting Example 4 (page 18)	Cable Diagram 4 (page 30)
	PCD4.M145 PCD4.M445	PCD4.C120 Port 1		RS232C	Setting Example 2 (page 14)	Cable Diagram 2 (page 28)		

Series	CPU	Link I/F	SIO Type	Setting Example	Cable Diagram
PCD	PCD4.M170	PCD2.F520	RS232C	Setting Example 2 (page 14)	Cable Diagram 3 (page 29)
			RS422/485 (2 wire)	Setting Example 4 (page 18)	Cable Diagram 4 (page 30)
			RS422/485 (4 wire)	Setting Example 5 (page 20)	Cable Diagram 6 (page 36)
		PCD2.F522	RS232C	Setting Example 2 (page 14)	Cable Diagram 3 (page 29)
	PCD6.M540	PGU (channel 0)	RS232C	Setting Example 1 (page 12)	Cable Diagram 1 (page 27)
		Channel 1	RS422/485 (4 wire)	Setting Example 5 (page 20)	Cable Diagram 5 (page 32)
		Channel 2	RS232C	Setting Example 2 (page 14)	Cable Diagram 2 (page 28)
	PCD6.M210	Channel 0 - 3	RS232C	Setting Example 2 (page 14)	Cable Diagram 2 (page 28)
	PCD6.M230	Channel 2, 3	RS232C	Setting Example 2 (page 14)	Cable Diagram 2 (page 28)

Series	CPU	Link I/F		SIO Type	Setting Example	Cable Diagram
PCD	PCD6.M220	Channel 2, 3		RS232C	Setting Example 2 (page 14)	Cable Diagram 2 (page 28)
		Channel 0, 1		RS422/485 (4 wire)	Setting Example 5 (page 20)	Cable Diagram 5 (page 32)
	PCD6.M260	Channel 0 - 3		RS422/485 (4 wire)	Setting Example 5 (page 20)	Cable Diagram 5 (page 32)
	PCD6.M300	PGU		RS232C	Setting Example 1 (page 12)	Cable Diagram 1 (page 27)
		Interface no.0-3A	PCD7.F110	RS422/485 (2 wire)	Setting Example 4 (page 18)	Cable Diagram 4 (page 30)
				RS422/485 (4 wire)	Setting Example 5 (page 20)	Cable Diagram 5 (page 32)
			PCD7.F120	RS232C	Setting Example 2 (page 14)	Cable Diagram 2 (page 28)
	PCD7.F150		RS422/485 (2 wire)	Setting Example 4 (page 18)	Cable Diagram 4 (page 30)	

■ Connection Configuration

- 1:1 Connection



- 1:n Connection

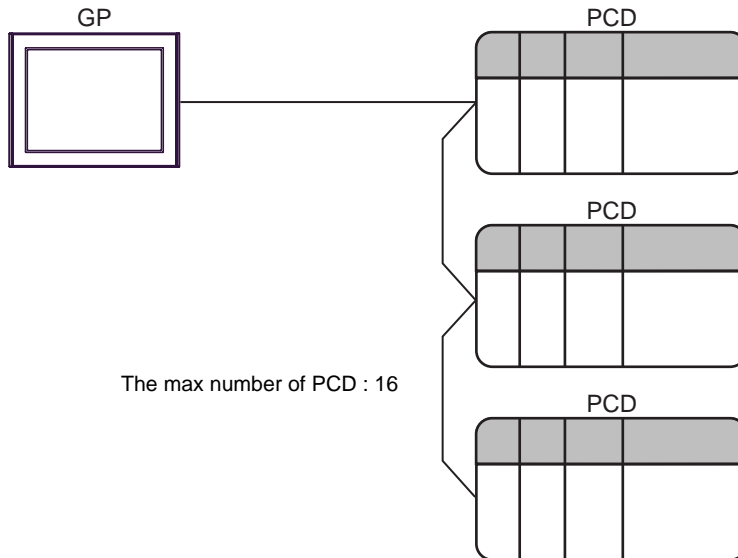

■ COM Port of IPC

When connecting IPC with External Device, the COM port which can be used changes with series and SIO type. Please refer to the manual of IPC for details.

Usable port

Series	Usable port		
	RS-232C	RS-422/485(4 wire)	RS-422/485(2 wire)
PS-2000B	COM1 ^{*1} , COM2, COM3 ^{*1} , COM4	-	-
PS-3450A, PS-3451A	COM1, COM2 ^{*1*2}	COM2 ^{*1*2}	COM2 ^{*1*2}
PS-3650A, PS-3651A	COM1 ^{*1}	-	-
PS-3700A (Pentium®4-M) PS-3710A	COM1 ^{*1} , COM2 ^{*1} , COM3 ^{*2} , COM4	COM3 ^{*2}	COM3 ^{*2}
PS-3711A	COM1 ^{*1} , COM2 ^{*2}	COM2 ^{*2}	COM2 ^{*2}
PL-3000B	COM1 ^{*1*2} , COM2 ^{*1} , COM3, COM4	COM1 ^{*1*2}	COM1 ^{*1*2}

*1 The RI/5V can be switched. Please switch with the change switch of IPC.

*2 It is necessary to set up the SIO type with the Dip switch. Please set up as follows according to SIO type to be used.

Dip switch setting: RS-232C

Dip switch	Setting	Description
1	OFF ^{*1}	Reserve (always OFF)
2	OFF	SIO type: RS-232C
3	OFF	
4	OFF	Output mode of SD (TXD) data: Always output
5	OFF	Terminal resistance (220Ω) insertion to SD (TXD): None
6	OFF	Terminal resistance (220Ω) insertion to RD (RXD): None
7	OFF	Short-circuit of SDA (TXA) and RDA (RXA): Does not Exist
8	OFF	Short-circuit of SDB (TXB) and RDB (RXB): Does not Exist
9	OFF	RS (RTS) Auto control mode: Disable
10	OFF	

*1 It is necessary to turn ON the set value, only when using PS-3450A and PS-3451A.

Dip switch setting: RS-422/485 (4 wire)

Dip switch	Setting	Description
1	OFF	Reserve (always OFF)
2	ON	SIO type: RS-422/485
3	ON	
4	OFF	Output mode of SD (TXD) data: Always output
5	OFF	Terminal resistance (220Ω) insertion to SD (TXD): None
6	OFF	Terminal resistance (220Ω) insertion to RD (RXD): None
7	OFF	Short-circuit of SDA (TXA) and RDA (RXA): Does not Exist
8	OFF	Short-circuit of SDB (TXB) and RDB (RXB): Does not Exist
9	OFF	RS (RTS) Auto control mode: Disable
10	OFF	

Dip switch setting: RS-422/485 (2 wire)

Dip switch	Setting	Description
1	OFF	Reserve (always OFF)
2	ON	SIO type: RS-422/485
3	ON	
4	OFF	Output mode of SD (TXD) data: Always output
5	OFF	Terminal resistance (220Ω) insertion to SD (TXD): None
6	OFF	Terminal resistance (220Ω) insertion to RD (RXD): None
7	ON	Short-circuit of SDA (TXA) and RDA (RXA): Exist
8	ON	Short-circuit of SDB (TXB) and RDB (RXB): Exist
9	ON	RS (RTS) Auto control mode: Enable
10	ON	

2 Selection of External Device

Select the External Device to be connected to the Display.

Setup Items	Setup Description
Maker	Select the maker of the External Device to be connected. Select "Saia-Burgess Controls Ltd."
Driver	Select a model (series) of the External Device to be connected and connection method. Select "Saia S-Bus SIO". Check the External Device which can be connected in "Saia S-Bus SIO" in system configuration. ☞ "1 System Configuration" (page 3)
Use System Area	Check this option when you synchronize the system data area of Display and the device (memory) of External Device. When synchronized, you can use the ladder program of External Device to switch the display or display the window on the display. Cf. GP-Pro EX Reference Manual "Appendix 1.4 LS Area (only for direct access method)" This can be also set with GP-Pro EX or in off-line mode of Display. Cf. GP-Pro EX Reference Manual " 5.14.6 Setting Guide of [System Setting Window]■[Main Unit Settings] Settings Guide◆System Area Setting" Cf. Maintenance/Troubleshooting "2.14.1 Settings common to all Display models ◆System Area Settings"
Port	Select the Display port to be connected to the External Device.

3 Example of Communication Setting

Examples of communication settings of the Display and the External Device, recommended by Pro-face, are shown.

3.1 Setting Example 1

■ Settings of GP-Pro EX

◆ Communication Settings

To display the setting screen, select [Device/PLC Settings] from [System setting window] in workspace.

◆ Device Setting

To display the setting screen, click ([Setting]) of External Device you want to set from [Device-Specific Settings] of [Device/PLC Settings].

When you connect multiple External Device, click from [Device-Specific Settings] of [Device/PLC Settings] to add another External Device.

■ Settings of External Device

Communication setting of external device by ladder soft (Saia PG5 Project Manager).

Please refer to the manual of external device for more detail.

- 1 External device is connected with the personal computer, and the power supply of external device is turned on.
External device starts in the STOP mode.
- 2 The ladder software is started, and [Hardware Settings] is selected from [CPU] menu.
- 3 The [PCD] tab in the [Hardware Settings] dialog box is clicked.
The series of external device is selected from PCD.
- 4 The [S-Bus] tab in the [Hardware Settings] dialog box is clicked.
The check is applied to [S-Bus Support], and the station number of external device is input to [S-Bus Station Number].
- 5 The [Serial] tab in the [Hardware Settings] dialog box is clicked.
The check on [Serial S-Bus Port] is removed.
- 6 The [Password] tab in the [Hardware Settings] dialog box is clicked.
The check on [Password Protection] is removed.
- 7 [Download] of the [Hardware Settings] dialog box is clicked.
The [Download] of the displayed dialog box is clicked.
- 8 The ladder program for the communication setting is made.
The [New] is selected from the menu that right-clicks in [Program Files] of the tree view and is displayed.

◆ Example of Ladder Program

- 9 The [Download Program] is selected from the [Online] menu.
The made ladder program is downloaded to external device.
- 10 External device is made RUN mode.

◆ Example of Ladder Program

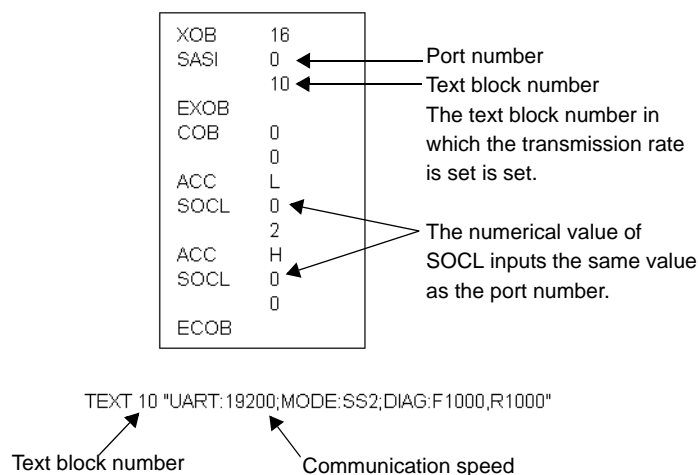

3.2 Setting Example 2

■ Settings of GP-Pro EX

◆ Communication Settings

To display the setting screen, select [Device/PLC Settings] from [System setting window] in workspace.

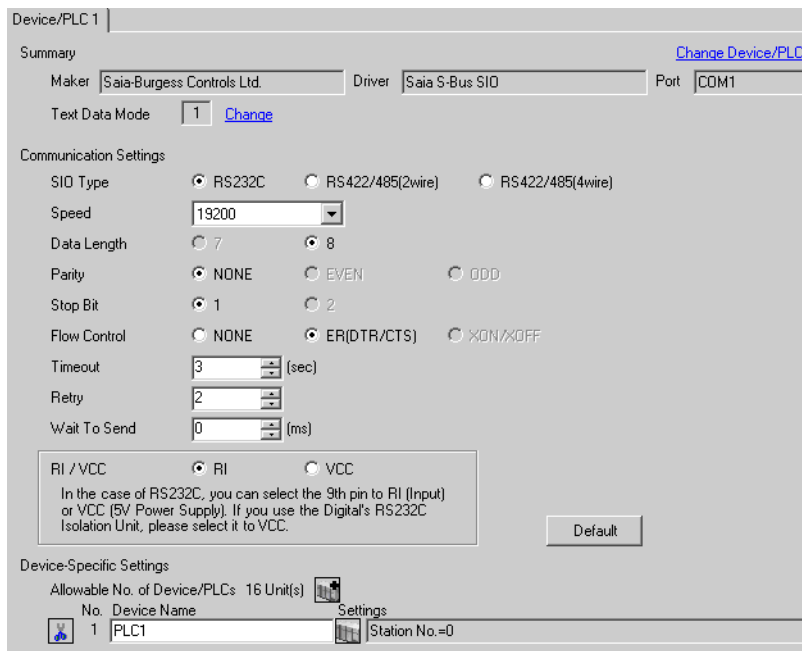

◆ Device Setting

To display the setting screen, click  ([Setting]) of External Device you want to set from [Device-Specific Settings] of [Device/PLC Settings].

When you connect multiple External Device, click  from [Device-Specific Settings] of [Device/PLC Settings] to add another External Device.

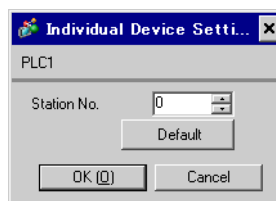

■ Settings of External Device

Communication setting of external device by ladder soft (Saia PG5 Project Manager).

Please refer to the manual of external device for more detail.

- 1 External device is connected with the personal computer, and the power supply of external device is turned on.
External device starts in the STOP mode.
 - 2 The ladder software is started, and [Hardware Settings] is selected from [CPU] menu.
 - 3 The [PCD] tab in the [Hardware Settings] dialog box is clicked.
The series of external device is selected from PCD.
 - 4 The [S-Bus] tab in the [Hardware Settings] dialog box is clicked.
The check is applied to [S-Bus Support], and the station number of external device is input to [S-Bus Station Number].
 - 5 The [Serial] tab in the [Hardware Settings] dialog box is clicked.
The check on [Serial S-Bus Port] is removed.
 - 6 The [Password] tab in the [Hardware Settings] dialog box is clicked.
The check on [Password Protection] is removed.
 - 7 [Download] of the [Hardware Settings] dialog box is clicked.
The [Download] of the displayed dialog box is clicked.
 - 8 The ladder program for the communication setting is made.
The [New] is selected from the menu that right-clicks in [Program Files] of the tree view and is displayed.
- 👉 ◆ Example of Ladder Program
- 9 The [Download Program] is selected from the [Online] menu.
The made ladder program is downloaded to external device.
 - 10 External device is made RUN mode.

◆ Example of Ladder Program

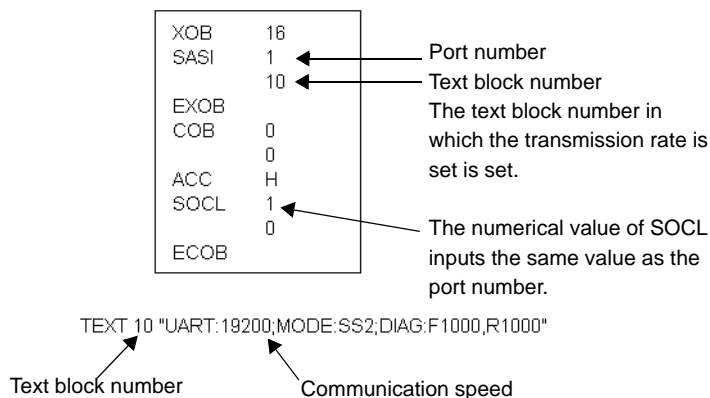

3.3 Setting Example 3

■ Settings of GP-Pro EX

◆ Communication Settings

To display the setting screen, select [Device/PLC Settings] from [System setting window] in workspace.

◆ Device Setting

To display the setting screen, click  ([Setting]) of External Device you want to set from [Device-Specific Settings] of [Device/PLC Settings].

When you connect multiple External Device, click  from [Device-Specific Settings] of [Device/PLC Settings] to add another External Device.

■ Settings of External Device

Communication setting of external device by ladder soft (Saia PG5 Project Manager).

Please refer to the manual of external device for more detail.

- 1 External device is connected with the personal computer, and the power supply of external device is turned on.
External device starts in the STOP mode.
- 2 The ladder software is started, and [Hardware Settings] is selected from [CPU] menu.
- 3 The [PCD] tab in the [Hardware Settings] dialog box is clicked.
The series of external device is selected from PCD.
- 4 The [S-Bus] tab in the [Hardware Settings] dialog box is clicked.
The check is applied to [S-Bus Support], and the station number of external device is input to [S-Bus Station Number].
- 5 The [Serial] tab in the [Hardware Settings] dialog box is clicked.
The check on [Serial S-Bus Port] is removed.
- 6 The [Password] tab in the [Hardware Settings] dialog box is clicked.
The check on [Password Protection] is removed.
- 7 [Download] of the [Hardware Settings] dialog box is clicked.
The [Download] of the displayed dialog box is clicked.
- 8 The ladder program for the communication setting is made.
The [New] is selected from the menu that right-clicks in [Program Files] of the tree view and is displayed.
 ◆ Example of Ladder Program
- 9 The [Download Program] is selected from the [Online] menu.
The made ladder program is downloaded to external device.
- 10 External device is made RUN mode.

◆ Example of Ladder Program

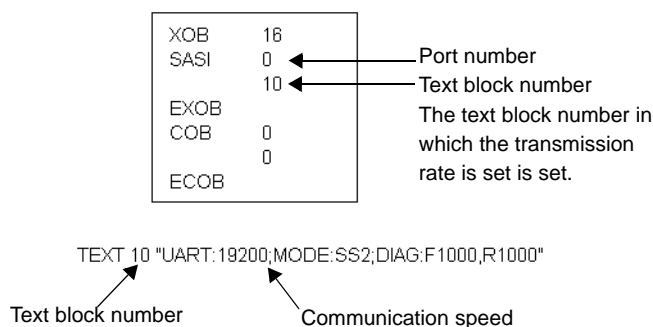

3.4 Setting Example 4

■ Settings of GP-Pro EX

◆ Communication Settings

To display the setting screen, select [Device/PLC Settings] from [System setting window] in workspace.

◆ Device Setting

To display the setting screen, click  ([Setting]) of External Device you want to set from [Device-Specific Settings] of [Device/PLC Settings].

When you connect multiple External Device, click  from [Device-Specific Settings] of [Device/PLC Settings] to add another External Device.

■ Settings of External Device

Communication setting of external device by ladder soft (Saia PG5 Project Manager).

Please refer to the manual of external device for more detail.

- 1 External device is connected with the personal computer, and the power supply of external device is turned on.
External device starts in the STOP mode.
- 2 The ladder software is started, and [Hardware Settings] is selected from [CPU] menu.
- 3 The [PCD] tab in the [Hardware Settings] dialog box is clicked.
The series of external device is selected from PCD.
- 4 The [S-Bus] tab in the [Hardware Settings] dialog box is clicked.
The check is applied to [S-Bus Support], and the station number of external device is input to [S-Bus Station Number].
- 5 The [Serial] tab in the [Hardware Settings] dialog box is clicked.
The check on [Serial S-Bus Port] is removed.
- 6 The [Password] tab in the [Hardware Settings] dialog box is clicked.
The check on [Password Protection] is removed.
- 7 [Download] of the [Hardware Settings] dialog box is clicked.
The [Download] of the displayed dialog box is clicked.
- 8 The ladder program for the communication setting is made.
The [New] is selected from the menu that right-clicks in [Program Files] of the tree view and is displayed.
 ◆ Example of Ladder Program
- 9 The [Download Program] is selected from the [Online] menu.
The made ladder program is downloaded to external device.
- 10 External device is made RUN mode.

◆ Example of Ladder Program

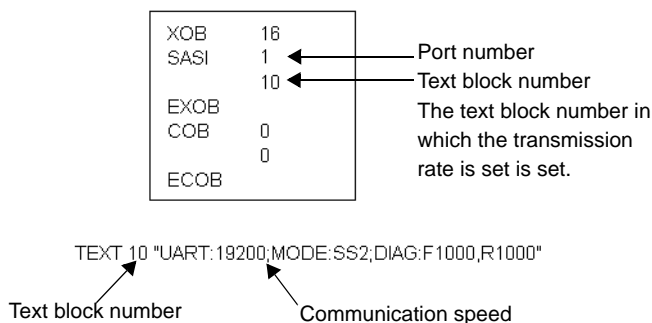

3.5 Setting Example 5

■ Settings of GP-Pro EX

◆ Communication Settings

To display the setting screen, select [Device/PLC Settings] from [System setting window] in workspace.

Device/PLC 1

Summary [Change Device/PLC](#)

Maker Driver Port

Text Data Mode [Change](#)

Communication Settings

SIO Type RS232C RS422/485(2wire) RS422/485(4wire)

Speed

Data Length 7 8

Parity NONE EVEN ODD

Stop Bit 1 2

Flow Control NONE ER(DTR/CTS) XON/XOFF

Timeout (sec)

Retry

Wait To Send (ms)

RI / VCC RI VCC

In the case of RS232C, you can select the 9th pin to RI (Input) or VCC (5V Power Supply). If you use the Digital's RS232C Isolation Unit, please select it to VCC.

Device-Specific Settings

Allowable No. of Device/PLCs: 16 Unit(s)

No.	Device Name	Settings
<input type="button" value="1"/>	PLC1	<input type="button" value="Settings"/> Station No.=0

◆ Device Setting

To display the setting screen, click ([Setting]) of External Device you want to set from [Device-Specific Settings] of [Device/PLC Settings].

When you connect multiple External Device, click from [Device-Specific Settings] of [Device/PLC Settings] to add another External Device.

Individual Device Setti...

PLC1

Station No.

■ Settings of External Device

Communication setting of external device by ladder soft (Saia PG5 Project Manager).

Please refer to the manual of external device for more detail.

- 1 External device is connected with the personal computer, and the power supply of external device is turned on.
External device starts in the STOP mode.
- 2 The ladder software is started, and [Hardware Settings] is selected from [CPU] menu.
- 3 The [PCD] tab in the [Hardware Settings] dialog box is clicked.
The series of external device is selected from PCD.
- 4 The [S-Bus] tab in the [Hardware Settings] dialog box is clicked.
The check is applied to [S-Bus Support], and the station number of external device is input to [S-Bus Station Number].
- 5 The [Serial] tab in the [Hardware Settings] dialog box is clicked.
The check on [Serial S-Bus Port] is removed.
- 6 The [Password] tab in the [Hardware Settings] dialog box is clicked.
The check on [Password Protection] is removed.
- 7 [Download] of the [Hardware Settings] dialog box is clicked.
The [Download] of the displayed dialog box is clicked.
- 8 The ladder program for the communication setting is made.
The [New] is selected from the menu that right-clicks in [Program Files] of the tree view and is displayed.

◆ Example of Ladder Program

- 9 The [Download Program] is selected from the [Online] menu.
The made ladder program is downloaded to external device.
- 10 External device is made RUN mode.

◆ Example of Ladder Program

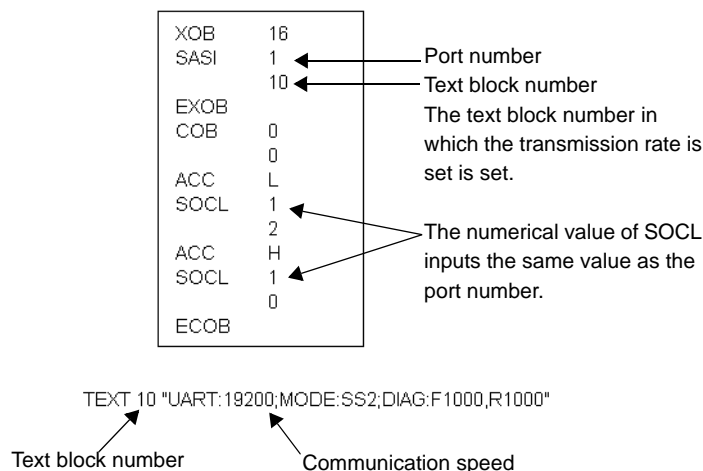

4 Setup Items

Set communication settings of the Display with GP-Pro EX or in off-line mode of the Display.

The setting of each parameter must be identical to that of External Device.

 "3 Example of Communication Setting" (page 12)

4.1 Setup Items in GP-Pro EX

■ Communication Settings

To display the setting screen, select [Device/PLC Settings] from [System setting window] in workspace.

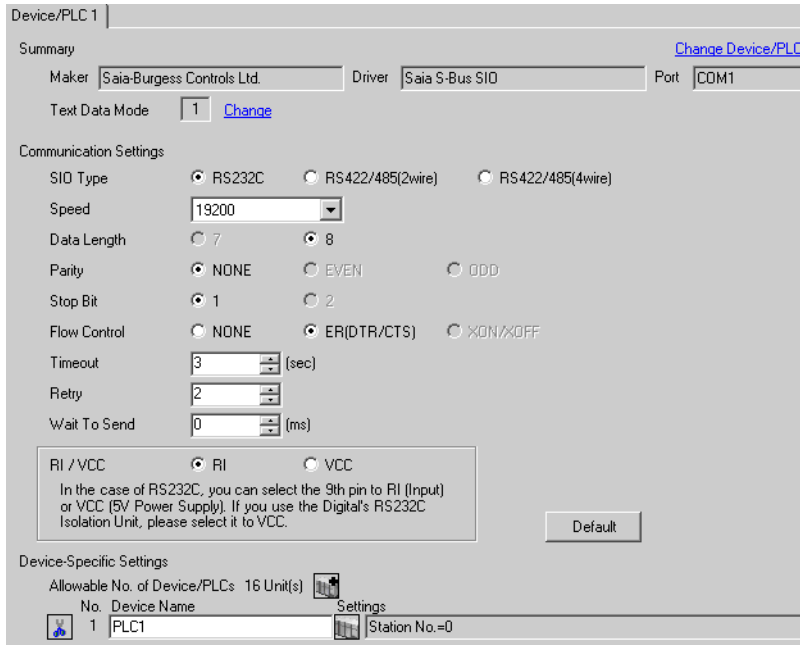

Device/PLC 1

Summary [Change Device/PLC](#)

Maker Driver Port

Text Data Mode [Change](#)

Communication Settings

SIO Type RS232C RS422/485(2wire) RS422/485(4wire)

Speed

Data Length 7 8

Parity NONE EVEN ODD

Stop Bit 1 2

Flow Control NONE ER(DTR/CTS) XON/XOFF

Timeout (sec)

Retry

Wait To Send (ms)

RI / VCC RI VCC

In the case of RS232C, you can select the 9th pin to RI (Input) or VCC (5V Power Supply). If you use the Digital's RS232C Isolation Unit, please select it to VCC.

Device-Specific Settings

Allowable No. of Device/PLCs: 16 Unit(s)

No.	Device Name	Settings
1	PLC1	Station No.=0

Setup Items	Setup Description
SIO Type	Select the SIO type to communicate with the External Device.
Speed	Select speed between the External Device and the Display.
Data Length	Select data length.
Parity	Select how to check parity.
Stop Bit	Select stop bit length.
Flow Control	Display the communication control method to prevent overflow of transmission and reception data.
Timeout	Use an integer from 1 to 127 to enter the time (s) for which the Display waits for the response from the External Device.
Retry	In case of no response from the External Device, use an integer from 0 to 255 to enter how many times the Display retransmits the command.
Wait To Send	Use an integer from 0 to 255 to enter standby time (ms) for the Display from receiving packets to transmitting next commands.
RI/VCC	You can switch RI/VCC of the 9th pin when you select RS232C for SIO type. It is necessary to change RI/5V by changeover switch of IPC when connect with IPC. Please refer to the manual of the IPC for more detail.

◆ Device Setting

To display the setting screen, click  ([Setting]) of External Device you want to set from [Device-Specific Settings] of [Device/PLC Settings].

When you connect multiple External Device, click  from [Device-Specific Settings] of [Device/PLC Settings] to add another External Device

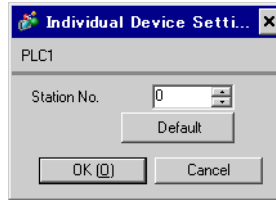

Setup Items	Setup Description
Station No.	Use an integer from 0 to 253 to enter the Station No. of the External Device. (Initial value [0])

4.2 Setup Items in Off-Line Mode

- NOTE** • Please refer to Maintenance/Troubleshooting for more information on how to enter off-line mode or about operation.
Cf. Maintenance/Troubleshooting "2.2 Offline Mode"

◆ Communication Settings

To display the setting screen, touch [Device/PLC Settings] from [Peripheral Settings] in off-line mode. Touch the External Device you want to set from the displayed list.

Comm.	Device	Option		
Saia S-Bus SIO			[COM1]	Page 1/1
SIO Type		RS232C		
Speed		19200		
Data Length		8		
Parity		NONE		
Stop Bit		1		
Flow Control		ER(DTR/CTS)		
Timeout(s)		3	▼ ▲	
Retry		2	▼ ▲	
Wait To Send(ms)		0	▼ ▲	
	Exit		Back	2006/06/30 22:13:17

Setup Items	Setup Description
SIO Type	Select the SIO type to communicate with the External Device. IMPORTANT To make the communication settings correctly, confirm the serial interface specifications of Display unit for [SIO Type]. We cannot guarantee the operation if a communication type that the serial interface does not support is specified. For details concerning the serial interface specifications, refer to the manual for Display unit.
Speed	Select speed between the External Device and the Display.
Data Length	Select data length.
Parity	Select how to check parity.
Stop Bit	Select stop bit length.
Flow Control	Display the communication control method to prevent overflow of transmission and reception data.
Timeout	Use an integer from 1 to 127 to enter the time (s) for which the Display waits for the response from the External Device.

Setup Items	Setup Description
Retry	In case of no response from the External Device, use an integer from 0 to 255 to enter how many times the Display retransmits the command.
Wait To Send	Use an integer from 0 to 255 to enter standby time (ms) for the Display from receiving packets to transmitting next commands.

■ Device Setting

To display the setting screen, touch [Device/PLC Settings] from [Peripheral Settings]. Touch the External Device you want to set from the displayed list, and touch [Device].

Comm.	Device	Option		
Saia S-Bus SIO		[COM1]	Page 1/1	
Device/PLC Name	[PLC1] ▼			
Station No.	[0] ▼ ▲			
Exit		Back		2006/06/30 22:13:19

Setup Items	Setup Description
Device/PLC Name	Select the External Device for device setting. Device name is a title of External Device set with GP-Pro EX.(Initial value [PLC1])
Station No.	Use an integer from 0 to 253 to enter the Station No. of the External Device. (Initial value [0])

◆ Option

To display the setting screen, touch [Device/PLC Settings] from [Peripheral Settings]. Touch the External Device you want to set from the displayed list, and touch [Option].

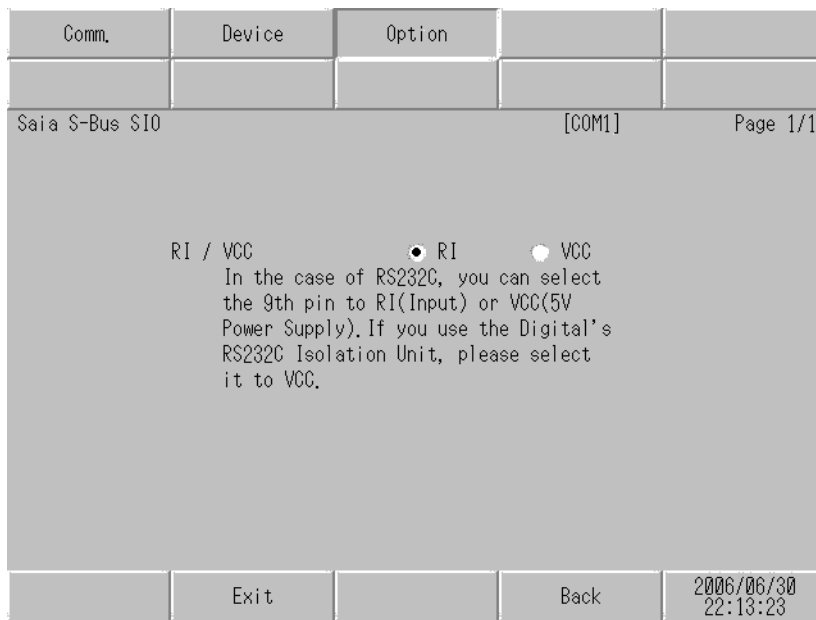

Setup Items	Setup Description
RI/VCC	You can switch RI/VCC of the 9th pin when you select RS232C for SIO type. It is necessary to change RI/5V by changeover switch of IPC when connect with IPC. Please refer to the manual of the IPC for more detail.

5 Cable Diagram

The cable diagram shown below may be different from the cable diagram recommended by Saia-Burgess Controls Ltd.. Please be assured there is no operational problem in applying the cable diagram shown in this manual.

- The FG pin of the External Device body must be D-class grounded. Please refer to the manual of the External Device for more details.
- SG and FG are connected inside the Display. When connecting SG to the External Device, design the system not to form short-circuit loop.
- Connect the isolation unit, when communication is not stabilized under the influence of a noise etc..

Cable Diagram 1

Display (Connection Port)	Cable	Notes
GP (COM1) IPC*1 PC/AT	Your own cable	

*1 Only the COM port which can communicate by RS-232C can be used.

- ☞ ■ COM Port of IPC (page 9)

When using your own cable

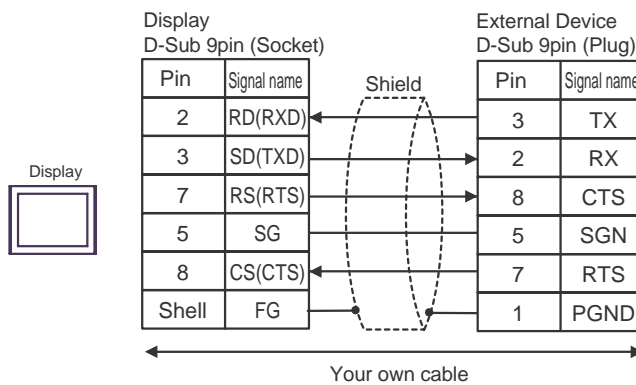

Cable Diagram 2

Display (Connection Port)	Cable	Notes
GP (COM1) IPC*1 PC/AT	Your own cable	When connecting PCD7.F120, PCD3.F121, PCD4.C120, PCD6.

*1 Only the COM port which can communicate by RS-232C can be used.

☞ ■ COM Port of IPC (page 9)

The pin assign in the interface is different according to external device. The pin assign of each series is as follows.

Please refer to the manual of the External Device for more details.

Series	PCD1 PCD2	PCD3	PCD4.Mxxx		PCD6.M540	PCD6.M2xx	PCD6.M300
Link I/F	PCD7.F120	PCD3.F121	C120	C340+ PCD7.F120	---	---	PCD7.F120
Interface	Port#1	Slot 0	Interface #1	Interface #1-3*1	Interface #2 D-sub 9pin	Interface #0-3*2 D-sub 25pin	Interface #0-3a D-sub 9pin
TX	11	1	10	x0	3	2	3
RX	12	2	11	x1	2	3	2
CTS	14	4	15	x 3	8	5	8
SGN	15	5	GND	GND	5	7	5
RTS	13	3	14	x 2	7	4	7
DTR	16	6	12	x 4	4	20	4
DSR	17	7	13	x 5	6	6	6
PGND	10	0	---	---	---	---	---

*1 The (x) has to be replaced by the interface number. Ex.) The CTS of interface 2 is "23".

*2 The interface number depends on the CPU type.

When using your own cable

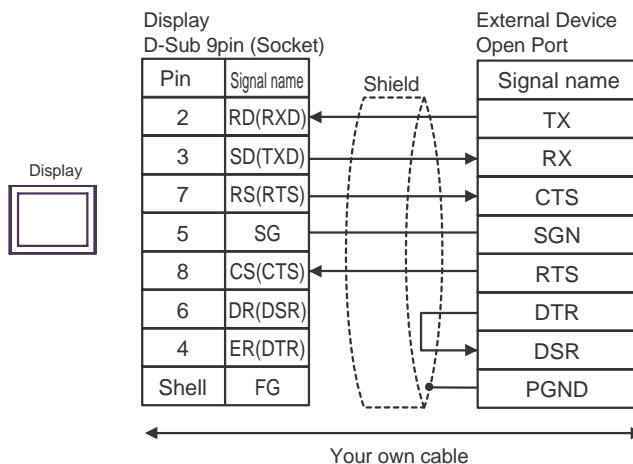

Cable Diagram 3

Display (Connection Port)	Cable	Notes
GP (COM1) IPC*1 PC/AT	Your own cable	When connecting it with series other than PCD7.F120, PCD3.F121, PCD4.C120, PCD6.

*1 Only the COM port which can communicate by RS-232C can be used.

☞ ■ COM Port of IPC (page 9)

The pin assign in the interface is different according to external device. The pin assign of each series is as follows. Please refer to the manual of the External Device for more details.

Series	PCD2 (Port #4,5 are M170/480 only)					
Link I/F	PCD2.F520/522*1			PCD2.F522*1		
Interface	Port#2 (screw terminal)	Port#4 (screw terminal)	Port #3 (screw terminal)	Port #3 (D-Sub 9 pin)	Port#5 (screw terminal)	Port#5 (D-Sub 9 pin)
TX	31	41	36	8	46	8
RX	32	42	37	3	47	3
CTS	34	44	39	5	49	5
SGN	30	40	35	1	45	1
RTS	33	43	38	6	48	6

Series	PCD4.M170		
Link I/F	PCD2.F520/522*1	PCD2.F522*1	
Interface	Port#4	Port#5	Port#3
TX	41	46	8
RX	42	47	3
CTS	44	49	6
SGN	40	45	1
RTS	43	48	5

*1 RS232c full mode should not be used.

When using your own cable

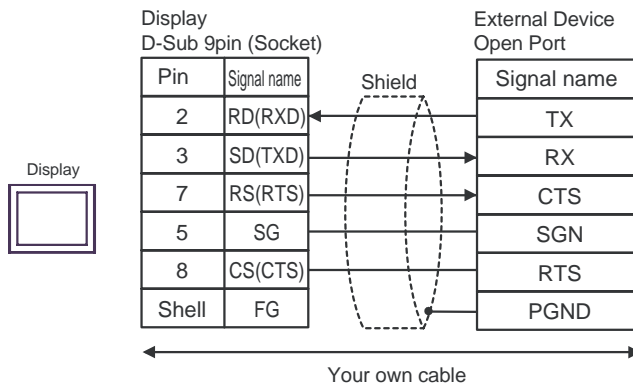

Cable Diagram 4

Display (Connection Port)	Cable	Notes
GP*1 (COM2)	Online adapter by Pro-face CA4-ADPONL-01 + Your own cable	The cable length must be 1000m or less.

*1 All GP models except GP-3200 series and AGP-3302B

NOTE • The use of RS485 isolation unit (CA3-ISO485-01) is recommended.

The pin assign in the interface is different according to external device. The pin assign of each series is as follows.
Please refer to the manual of the External Device for more details.

Series	PCD1.M110	PCD2.M1x0	PCD2.M480	PCD1.MxxxPCD2.Mxxx	
Link I/F	---	---	---	PCD7.F110	PCD7.F150*3
Interface	Port#1*1	Port#0 *1	Port#6*1	Port#1*1	Port#1
RX-TX	11	29	29	11	11
/RX-/TX	12	28	28	12	12
PGND	10	---	---	10	Isolated

Series	PCD2.Mxxx				PCD3		
Link I/F	PCD2.F520*1 (Port#5 is M170/480 only)				PCD3.F110*1	PCD3.F150+ PCD7.F150	---
Interface	Port #3 (screw terminal)	Port #3 (D- Sub 9 pin)	Port#5 (screw terminal)	Port #5 (D- Sub 9 pin)	Port#1	Port#1	Port#2
RX-TX	36	8	46	8	1	1	1
/RX-/TX	37	3	47	3	2	2	2
PGND	35	1	45	1	0	Isolated	---

Series	PCD4.Mxxx		PCD4.M170		PCD6.M300	
Link I/F	C340+PCD7. F110*1	C340+PCD7. F150	PCD2.F520		PCD7.F110	PCD7.F150
Interface	Interface #1- 3*4	Interface #1- 3*4	Port#5 (screw terminal)	Port#5 D-sub 9pin	D-sub 9pin	D-sub 9pin
RX-TX	x0	x0	46	8	3	3
/RX-/TX	x1	x1	47	3	2	2
PGND	GND	Isolated	45	1	5	Isolated

*1 At the first and last stations, the jumper must be set to the "CLOSED" position.
At all other stations, the jumper must be set to "OPEN" (factory setting).

*2 Except PCD1.M110.

*3 The (x) has to be replaced by the interface number. Ex.) The RX-TX of interface 3 is "30".

When using the online adapter (CA4-ADPONL-01) by Pro-face and your own cable

- 1:1 Connection

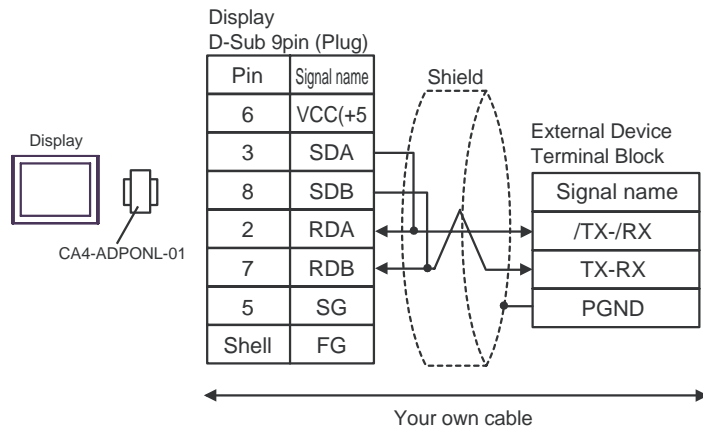

- 1:n Connection

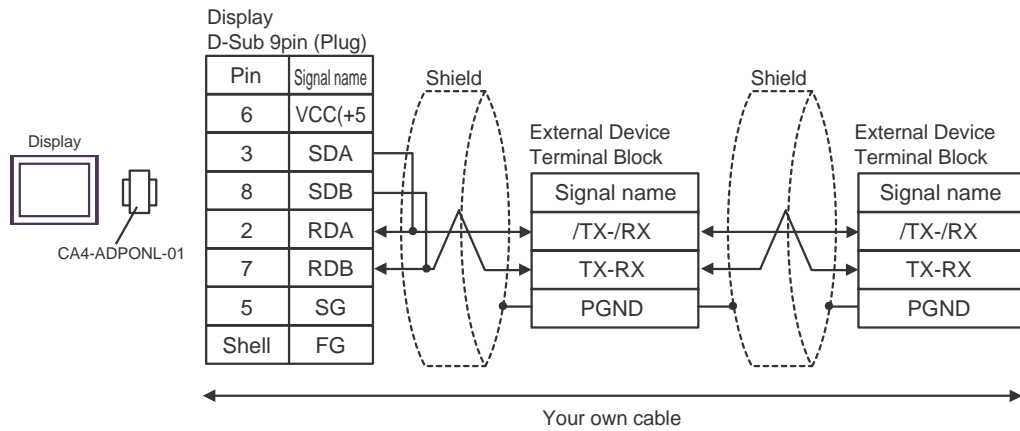

Cable Diagram 5

Display (Connection Port)	Cable		Notes
GP ^{*1} (COM1) AGP-3302B (COM2) IPC ^{*2}	A	COM port conversion adapter by Pro-face CA3-ADPCOM-01 + Terminal block conversion adapter by Pro-face CA3-ADPTRM-01 + Your own cable	
	B	Your own cable	
GP ^{*3} (COM2)	C	Online adapter by Pro-face CA4-ADPONL-01 + Terminal block conversion adapter by Pro-face CA3-ADPTRM-01 + Your own cable	
	D	Online adapter by Pro-face CA4-ADPONL-01 + Your own cable	

*1 All GP models except AGP-3302B

*2 Only the COM port which can communicate by RS-422/485 (4 wire) can be used.

 ■ COM Port of IPC (page 9)

*3 All GP models except GP-3200 series and AGP-3302B

The pin assign in the interface is different according to external device. The pin assign of each series is as follows. Please refer to the manual of the External Device for more details.

Series	PCD1PCD2	PCD3	PCD4	PCD6.M540	PCD6.M100/ M2x0	PCD6.M300
Link I/F	PCD7.F110	PCD3.F110	C340+ PCD7.F110*1	---	PCD7.F110*1	PCD7.F110*1
Interface	Port#1*1	Port#1*1	Interface #1-3*2	Interface #1	Interface #0-3 D-sub 25 pin	Interface #0-3a D-sub 9 pin
Tx	11	1	x 0	3	2	3
/Tx	12	2	x 1	4	9	2
Rx	13	3	x 2	2	4	7
/Rx	14	4	x 3	1	11	8
SGND	15	5	GND	5	13	5
CTS	18	8	x 6	8	5	9
RTS	16	6	x 4	7	3	4
/CTS	19	9	x 7	6	12	1
/RTS	17	7	x 5	9	10	6
PGND	Shell	0	---	---	1	---

*1 For RS 422, each pair of receive lines is terminated with a 150 Ω line termination resistor. Jumper J1 must be left in the "OPEN" position (factory setting). The jumper is on the connection side of the module.

*2 The (x) has to be replaced by the interface number. Ex.) The Tx of interface 3 is "30".

A) When using the COM port conversion adapter (CA3-ADPCOM-01), the terminal block conversion adapter (CA3-ADPTRM-01) by Pro-face and your own cable

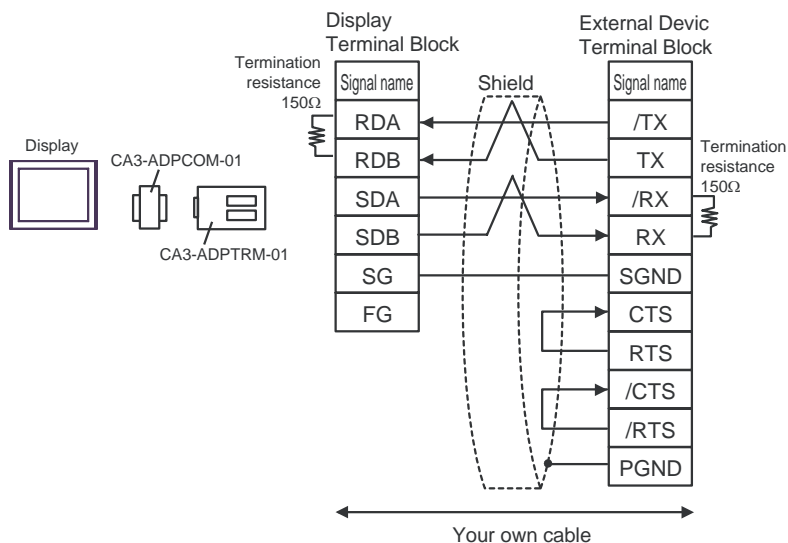

B) When using your own cable

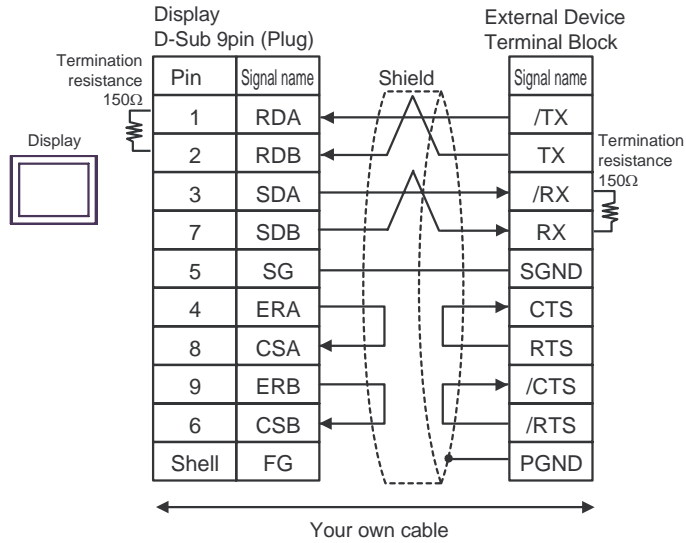

C) When using the online adapter (CA4-ADPONL-01), the terminal block conversion adapter (CA3-ADPTRM-01) by Pro-face and your own cable

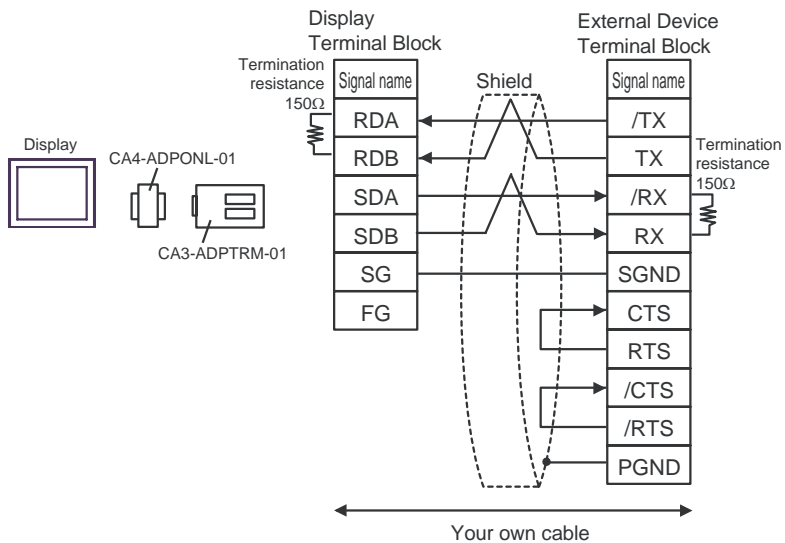

D) When using the online adapter (CA4-ADPONL-01) by Pro-face and your own cable

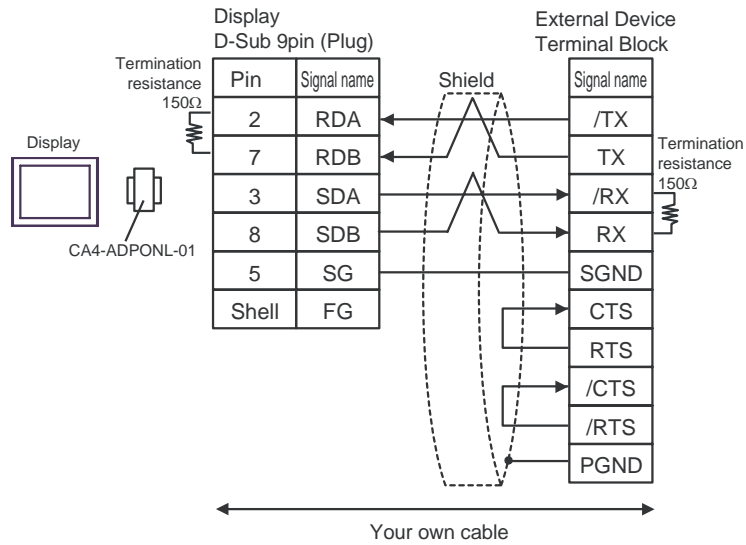

Cable Diagram 6

Display (Connection Port)	Cable		Notes
GP* ¹ (COM1) AGP-3302B (COM2) IPC* ²	A	COM port conversion adapter by Pro-face CA3-ADPCOM-01 + Terminal block conversion adapter by Pro-face CA3-ADPTRM-01 + Your own cable	
	B	Your own cable	
GP* ³ (COM2)	C	Online adapter by Pro-face CA4-ADPONL-01 + Terminal block conversion adapter by Pro-face CA3-ADPTRM-01 + Your own cable	
	D	Online adapter by Pro-face CA4-ADPONL-01 + Your own cable	

*1 All GP models except AGP-3302B

*2 Only the COM port which can communicate by RS-422/485 (4 wire) can be used.

 ■ COM Port of IPC (page 9)

*3 All GP models except GP-3200 series and AGP-3302B

The pin assign in the interface is different according to external device. The pin assign of each series is as follows.

Please refer to the manual of the External Device for more details.

Series	PCD2				PCD4.M170	
Link I/F	PCD2.F520				PCD2.F520	
Interface	Port#3 (screw terminal)	Port#3 D-Sub 9pin	Port#5 (screw terminal)	Port#5 D-Sub 9pin	Port#5 (screw terminal)	Port#5 D-sub 9pin
Tx	36	8	46	8	46	8
/Tx	37	3	47	3	47	3
Rx	38	6	48	6	48	6
/Rx	39	5	49	5	49	5
SGND	35	1	45	1	45	1

A) When using the COM port conversion adapter (CA3-ADPCOM-01), the terminal block conversion adapter (CA3-ADPTRM-01) by Pro-face and your own cable

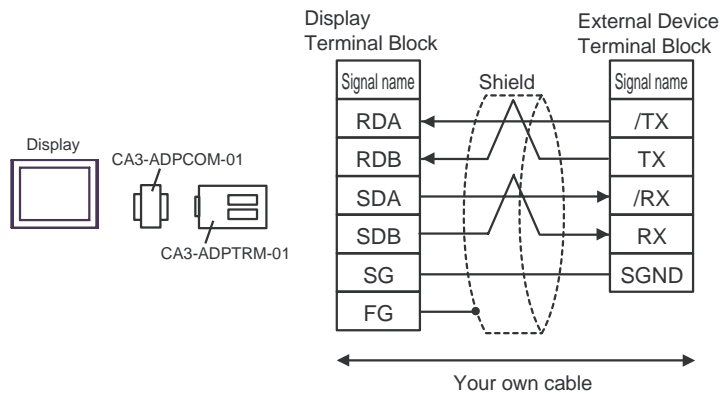

B) When using your own cable

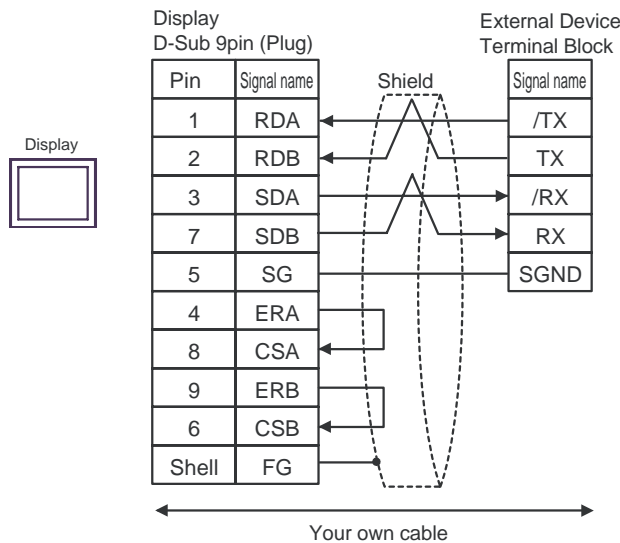

C) When using the online adapter (CA4-ADPONL-01), the terminal block conversion adapter (CA3-ADPTRM-01) by Pro-face and your own cable

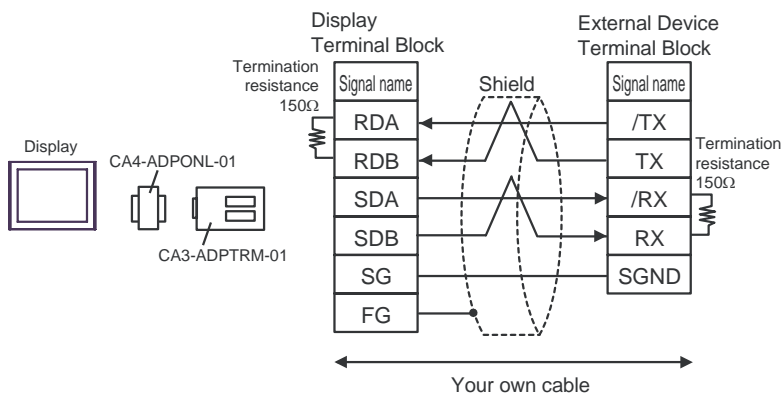

D) When using the online adapter (CA4-ADPONL-01) by Pro-face and your own cable

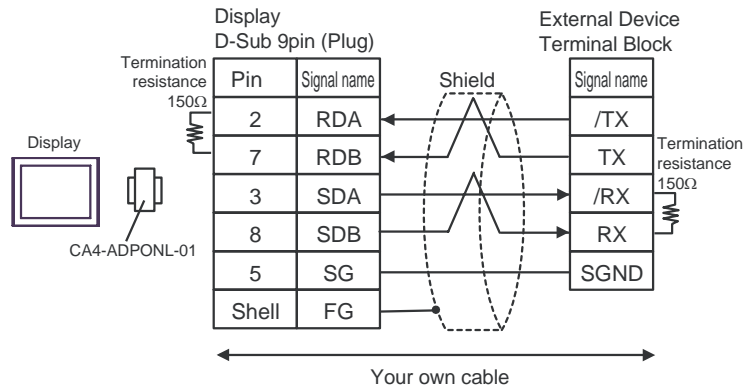







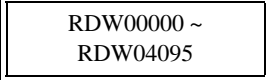

6 Supported Device

Range of supported device address is shown in the table below. Please note that the actually supported range of the devices varies depending on the External Device to be used. Please check the actual range in the manual of your connecting equipment.

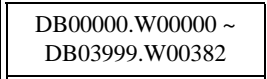
6.1 PCD1 Series

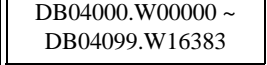
 This address can be specified as system data area.

Device	Bit Address	Word Address	32 bits	Notes
Internal Bit	F00000 ~ F08191	F00000 ~ F08176	L / H	 *1
Input Bit	I00000 ~ I00063	I00000 ~ I00048		 *2
Output Bit	O00000 ~ O00063	O00000 ~ O00048		 *1
Register Dword	RDX00000.00 ~ RDX04095.31	 RDW00000 ~ RDW04095	---	 *1
Timer Word	---	T00000 ~ T01599		
Counter Word	---	C00000 ~ C01599		
Data Block (0 ~ 3999)	DB00000.W00000.00~ DB03999.W00382.31	 DB00000.W00000 ~ DB03999.W00382		 *1
Data Block (4000 ~ 4099)	DB04000.W00000.00~ DB04099.W16383.31	 DB04000.W00000 ~ DB04099.W16383		 *1

*1 This is a discrete device but it can be written by only word data. When it is used for bit set or reset, AGP will write the word data that is modified from the read data before write. It has a possibility to happen the conflict between AGP and the PLC ladder program.











*2 Write disable

NOTE

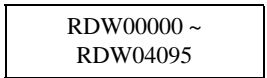
- Please refer to the GP-Pro EX Reference Manual for system data area.
Cf. GP-Pro EX Reference Manual "Appendix 1.4 LS Area (only for direct access method)"
- Please refer to the precautions on manual notation for icons in the table.
 "Manual Symbols and Terminology"

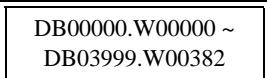
6.2 PCD2 .M110

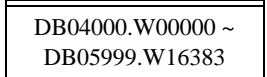
 This address can be specified as system data area.

Device	Bit Address	Word Address	32 bits	Notes
Internal Bit	F00000 ~ F08191	F00000 ~ F08176		 *1
Input Bit(*1)	I00000 ~ I00127	I00000 ~ I00112		 *2
Output Bit(*1)	O00000 ~ O00127	O00000 ~ O00112		 *1
Register Dword	RDX00000.00 ~ RDX04095.31	 RDW00000 ~ RDW04095	---	 *1
Timer Word	---	T00000 ~ T01599		
Counter Word	---	C00000 ~ C01599		
Data Block (0 ~ 3999)	DB00000.W00000.00~ DB03999.W00382.31	 DB00000.W00000 ~ DB03999.W00382		 *1
Data Block (4000 ~ 5999)	DB04000.W00000.00~ DB05999.W16383.31	 DB04000.W00000 ~ DB05999.W16383		 *1

*1 This is a discrete device but it can be written by only word data. When it is used for bit set or reset, AGP will write the word data that is modified from the read data before write. It has a possibility to happen the conflict between AGP and the PLC ladder program.











*2 Write disable

NOTE

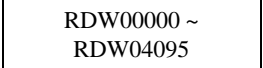
- Please refer to the GP-Pro EX Reference Manual for system data area.
Cf. GP-Pro EX Reference Manual "Appendix 1.4 LS Area (only for direct access method)"
- Please refer to the precautions on manual notation for icons in the table.
 "Manual Symbols and Terminology"

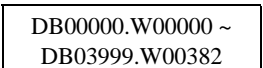
6.3 PCD2 .M120/M150

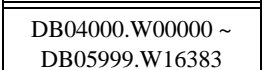
 This address can be specified as system data area.

Device	Bit Address	Word Address	32 bits	Notes
Internal Bit	F00000 ~ F08191	F00000 ~ F08176		 *1
Input Bit(*1)	I00000 ~ I00255	I00000 ~ I00240		 *2
Output Bit(*1)	O00000 ~ O00255	O00000 ~ O00240		 *1
Register Dword	RDX00000.00 ~ RDX04095.31	 RDW00000 ~ RDW04095	---	 *1
Timer Word	---	T00000 ~ T01599		
Counter Word	---	C00000 ~ C01599		
Data Block (0 ~ 3999)	DB00000.W00000.00~ DB03999.W00382.31	 DB00000.W00000 ~ DB03999.W00382		 *1
Data Block (4000 ~ 5999)	DB04000.W00000.00~ DB05999.W16383.31	 DB04000.W00000 ~ DB05999.W16383		 *1

*1 This is a discrete device but it can be written by only word data. When it is used for bit set or reset, AGP will write the word data that is modified from the read data before write. It has a possibility to happen the confliction between AGP and the PLC ladder program.











*2 Write disable

NOTE

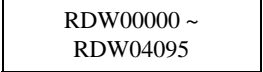
- Please refer to the GP-Pro EX Reference Manual for system data area.
Cf. GP-Pro EX Reference Manual "Appendix 1.4 LS Area (only for direct access method)"
- Please refer to the precautions on manual notation for icons in the table.
 "Manual Symbols and Terminology"

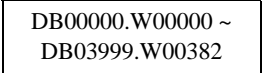
6.4 PCD2 .M170

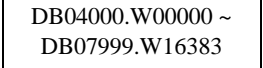
 This address can be specified as system data area.

Device	Bit Address	Word Address	32 bits	Notes
Internal Bit	F00000 ~ F08191	F00000 ~ F08176		 *1
Input Bit	I00000 ~ I00255	I00000 ~ I00240		 *2
Output Bit	O00000 ~ O00255	O00000 ~ O00240		 *1
Register Dword	RDX00000.00 ~ RDX04095.31	 RDW00000 ~ RDW04095	---	 *1
Timer Word	---	T00000 ~ T01599		
Counter Word	---	C00000 ~ C01599		
Data Block (0 ~ 3999)	DB00000.W00000.00~ DB03999.W00382.31	 DB00000.W00000 ~ DB03999.W00382		 *1
Data Block (4000 ~ 7999)	DB04000.W00000.00~ DB07999.W16383.31	 DB04000.W00000 ~ DB07999.W16383		 *1

*1 This is a discrete device but it can be written by only word data. When it is used for bit set or reset, AGP will write the word data that is modified from the read data before write. It has a possibility to happen the conflict between AGP and the PLC ladder program.











*2 Write disable

NOTE

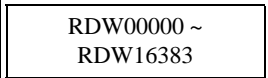
- Please refer to the GP-Pro EX Reference Manual for system data area.
Cf. GP-Pro EX Reference Manual "Appendix 1.4 LS Area (only for direct access method)"
- Please refer to the precautions on manual notation for icons in the table.
 "Manual Symbols and Terminology"

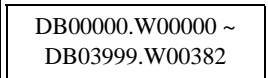
6.5 PCD2 .M480

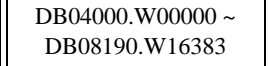
 This address can be specified as system data area.

Device	Bit Address	Word Address	32 bits	Notes
Internal Bit	F00000 ~ F08191	F00000 ~ F08176		 *1
Input Bit	I00000 ~ I00255	I00000 ~ I00240		 *2
Output Bit	O00000 ~ O00255	O00000 ~ O00240		 *1
Register Dword	RDX00000.00 ~ RDX16383.31	 RDW00000 ~ RDW16383	---	 *1
Timer Word	---	T00000 ~ T01599		
Counter Word	---	C00000 ~ C01599		
Data Block (0 ~ 3999)	DB00000.W00000.00~ DB03999.W00382.31	 DB00000.W00000 ~ DB03999.W00382		 *1
Data Block (4000 ~ 8190)	DB04000.W00000.00~ DB08190.W16383.31	 DB04000.W00000 ~ DB08190.W16383		 *1

*1 This is a discrete device but it can be written by only word data. When it is used for bit set or reset, AGP will write the word data that is modified from the read data before write. It has a possibility to happen the confliction between AGP and the PLC ladder program.











*2 Write disable

NOTE

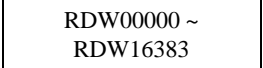
- Please refer to the GP-Pro EX Reference Manual for system data area.
Cf. GP-Pro EX Reference Manual "Appendix 1.4 LS Area (only for direct access method)"
- Please refer to the precautions on manual notation for icons in the table.
 "Manual Symbols and Terminology"

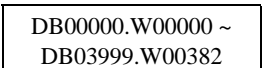
6.6 PCD3 .M3020

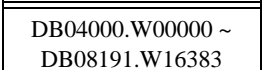
 This address can be specified as system data area.

Device	Bit Address	Word Address	32 bits	Notes
Internal Bit	F00000 ~ F08191	F00000 ~ F08176		 *1
Input Bit	I00000 ~ I00063	I00000 ~ I00048		 *2
Output Bit	O00000 ~ O00063	O00000 ~ O00048		 *1
Register Dword	RDX00000.00 ~ RDX16383.31	 RDW00000 ~ RDW16383	---	 *1
Timer Word	---	T00000 ~ T01599		
Counter Word	---	C00000 ~ C01599		
Data Block (0 ~ 3999)	DB00000.W00000.00~ DB03999.W00382.31	 DB00000.W00000 ~ DB03999.W00382		 *1
Data Block (4000 ~ 8191)	DB04000.W00000.00~ DB08191.W16383.31	 DB04000.W00000 ~ DB08191.W16383		 *1

*1 This is a discrete device but it can be written by only word data. When it is used for bit set or reset, AGP will write the word data that is modified from the read data before write. It has a possibility to happen the conflict between AGP and the PLC ladder program.











*2 Write disable

NOTE

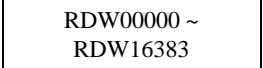
- Please refer to the GP-Pro EX Reference Manual for system data area.
Cf. GP-Pro EX Reference Manual "Appendix 1.4 LS Area (only for direct access method)"
- Please refer to the precautions on manual notation for icons in the table.
 "Manual Symbols and Terminology"

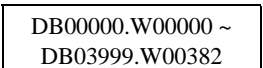
6.7 PCD3 .M3230/3330/5440/5540

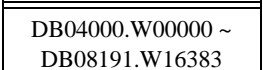
 This address can be specified as system data area.

Device	Bit Address	Word Address	32 bits	Notes
Internal Bit	F00000 ~ F08191	F00000 ~ F08176		 *1
Input Bit	I00000 ~ I01023	I00000 ~ I01008		 *2
Output Bit	O00000 ~ O01023	O00000 ~ O01008		 *1
Register Dword	RDX00000.00 ~ RDX16383.31	 RDW00000 ~ RDW16383	---	 *1
Timer Word	---	T00000 ~ T01599		
Counter Word	---	C00000 ~ C01599		
Data Block (0 ~ 3999)	DB00000.W00000.00~ DB03999.W00382.31	 DB00000.W00000 ~ DB03999.W00382		 *1
Data Block (4000 ~ 8191)	DB04000.W00000.00~ DB08191.W16383.31	 DB04000.W00000 ~ DB08191.W16383		 *1

*1 This is a discrete device but it can be written by only word data. When it is used for bit set or reset, AGP will write the word data that is modified from the read data before write. It has a possibility to happen the confliction between AGP and the PLC ladder program.











*2 Write disable

NOTE

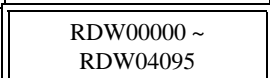
- Please refer to the GP-Pro EX Reference Manual for system data area.
Cf. GP-Pro EX Reference Manual "Appendix 1.4 LS Area (only for direct access method)"
- Please refer to the precautions on manual notation for icons in the table.
 "Manual Symbols and Terminology"

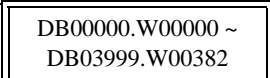
6.8 PCD4

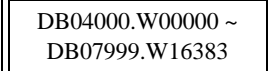
 This address can be specified as system data area.

Device	Bit Address	Word Address	32 bits	Notes
Internal Bit	F00000 ~ F08191	F00000 ~ F08176		 *1
Input Bit	I00000 ~ I00511	I00000 ~ I00496		 *2
Output Bit	O00000 ~ O00511	O00000 ~ O00496		 *1
Register Dword	RDX00000.00 ~ RDX04095.31	 RDW00000 ~ RDW04095	---	 *1
Timer Word	---	T00000 ~ T01599		
Counter Word	---	C00000 ~ C01599		
Data Block (0 ~ 3999)	DB00000.W00000.00~ DB03999.W00382.31	 DB00000.W00000 ~ DB03999.W00382		 *1
Data Block (4000 ~ 7999)	DB04000.W00000.00~ DB07999.W16383.31	 DB04000.W00000 ~ DB07999.W16383		 *1

*1 This is a discrete device but it can be written by only word data. When it is used for bit set or reset, AGP will write the word data that is modified from the read data before write. It has a possibility to happen the conflict between AGP and the PLC ladder program.











*2 Write disable

NOTE

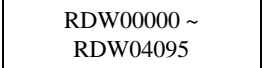
- Please refer to the GP-Pro EX Reference Manual for system data area.
Cf. GP-Pro EX Reference Manual "Appendix 1.4 LS Area (only for direct access method)"
- Please refer to the precautions on manual notation for icons in the table.
 "Manual Symbols and Terminology"

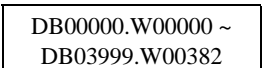
6.9 PCD6

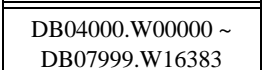
 This address can be specified as system data area.

Device	Bit Address	Word Address	32 bits	Notes
Internal Bit	F00000 ~ F08191	F00000 ~ F08176		 *1
Input Bit	I00000 ~ I005119	I00000 ~ I005104		 *2
Output Bit	O00000 ~ O005119	O00000 ~ O005104		 *1
Register Dword	RDX00000.00 ~ RDX04095.31	 RDW00000 ~ RDW04095	---	 *1
Timer Word	---	T00000 ~ T01599		
Counter Word	---	C00000 ~ C01599		
Data Block (0 ~ 3999)	DB00000.W00000.00~ DB03999.W00382.31	 DB00000.W00000 ~ DB03999.W00382		 *1
Data Block (4000 ~ 7999)	DB04000.W00000.00~ DB07999.W16383.31	 DB04000.W00000 ~ DB07999.W16383		 *1

*1 This is a discrete device but it can be written by only word data. When it is used for bit set or reset, AGP will write the word data that is modified from the read data before write. It has a possibility to happen the confliction between AGP and the PLC ladder program.

*2 Write disable

NOTE

- Please refer to the GP-Pro EX Reference Manual for system data area.
Cf. GP-Pro EX Reference Manual "Appendix 1.4 LS Area (only for direct access method)"
- Please refer to the precautions on manual notation for icons in the table.
 "Manual Symbols and Terminology"

7 Device Code and Address Code

Use device code and address code when you select "Device Type & Address" for the address type in data displays.

Device	Device Name	Device Code (HEX)	Address Code
Input Relay	I	80	Word Address/16
Output Relay	O	81	Word Address/16
Internal Bit	F	82	Word Address/16
Timer Word	T	60	Word Address
Counter Word	C	61	Word Address
Data Block	DB	00	(Data Block Number x 0x10000) + Word Address
Register DWord	RD	01	Word Address

8 Error Messages

Error messages are displayed on the screen of Display as follows: "No. : Device Name: Error Message (Error Occurrence Area)". Each description is shown below.

Item	Description
No.	Error No.
Device Name	Name of External Device where error occurs. Device name is a title of External Device set with GP-Pro EX. (Initial value [PLC1])
Error Message	Displays messages related to the error which occurs.
Error Occurrence Area	Displays IP address or device address of External Device where error occurs, or error codes received from External Device. <div style="border: 1px solid black; padding: 2px; margin: 5px 0;">NOTE</div> <ul style="list-style-type: none"> IP address is displayed such as "IP address (Decimal): MAC address (Hex)". Device address is displayed such as "Address: Device address". Received error codes are displayed such as "Decimal [Hex]".

Display Examples of Error Messages

"RHAA035:PLC1: Error has been responded for device write command (Error Code: 2 [02H])"

NOTE

- Please refer to the manual of External Device for more detail of received error codes.
- Please refer to "When an error message is displayed (Error code list)" of "Maintenance/Troubleshooting" for a common error message to the driver.

■ Error Code Peculiar to External Device

The error code peculiar to External Device is as follows.

Error Code	Description	Comment
0x01	NAK	If a command from Display is not acceptable for PCD because of such reasons as exceeding its address range, unconfigured DB, this will be returned. No more information will be provided from PCDs.
0x02	NAK because of password	The PCD is locked against data communication. It must be first unlocked by the programming software.
0x03	NAK because the port is configured with the reduced protocol	This error code will be issued only when the programming software tries to access PCD while it is communicating in the data communication mode.
0x04	NAK because the port is occupied for programming	The port is not configured for data mode. The External Device has to be re-configured with the ladder application.

