



FX Series CPU Direct Driver

1	System Configuration.....	3
2	Selection of External Device	7
3	Example of Communication Setting.....	8
4	Setup Items.....	11
5	Cable Diagram	15
6	Supported Device.....	34
7	Device Code and Address Code.....	40
8	Error Messages.....	41

Introduction

This manual describes how to connect the Display and the External Device (target PLC).

In this manual, the connection procedure will be described by following the below sections:

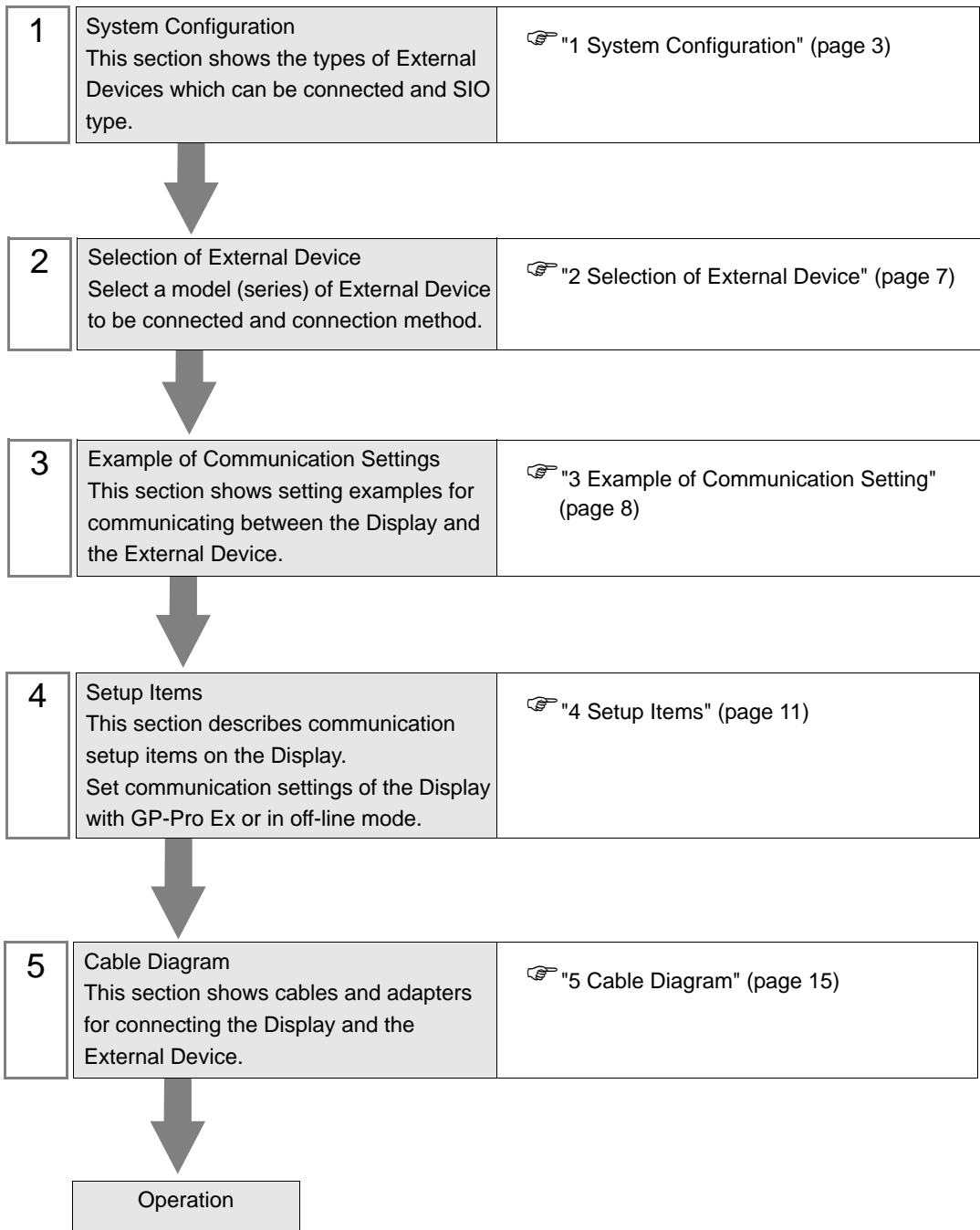

1 System Configuration

The system configuration in the case when the External Device of Mitsubishi Electric Corp. and the Display are connected is shown.

Series	CPU	Link I/F	SIO Type	Setting Example	Cable Diagram
MELSEC FX Series	FX1	CPU Direct	RS232C	Setting Example 1 (page 8)	Cable Diagram 1 (page 15)
	FX2	CPU Direct	RS232C	Setting Example 1 (page 8)	Cable Diagram 1 (page 15)
		2-port adapter II by Pro-face (Model: GP070-MD11)	RS422/485 (4wire)	Setting Example 3 (page 10)	Cable Diagram 10 (page 27)
	FX2C	CPU Direct	RS232C	Setting Example 1 (page 8)	Cable Diagram 1 (page 15)
	FX0S	CPU Direct	RS422/485 (4wire)	Setting Example 2 (page 9)	Cable Diagram 2 (page 16)
		2-port adapter II by Pro-face (Model: GP070-MD11)	RS422/485 (4wire)	Setting Example 3 (page 10)	Cable Diagram 10 (page 27)
	FX0N	CPU Direct	RS422/485 (4wire)	Setting Example 2 (page 9)	Cable Diagram 2 (page 16)
		FX2NC-232ADP	RS232C	Setting Example 1 (page 8)	Cable Diagram 9 (page 26)
		2-port adapter II by Pro-face (Model: GP070-MD11)	RS422/485 (4wire)	Setting Example 3 (page 10)	Cable Diagram 10 (page 27)
	FX1S, FX1N	CPU Direct	RS422/485 (4wire)	Setting Example 2 (page 9)	Cable Diagram 2 (page 16)
		FX1N-232-BD	RS232C	Setting Example 1 (page 8)	Cable Diagram 3 (page 17)
		FX0N-232ADP + FX1N-CNV-BD	RS232C	Setting Example 1 (page 8)	Cable Diagram 4 (page 18)
		FX2NC-232ADP + FX1N-CNV-BD	RS232C	Setting Example 1 (page 8)	Cable Diagram 7 (page 22)
		FX1N-422-BD	RS422/485 (4wire)	Setting Example 2 (page 9)	Cable Diagram 6 (page 21)
		2-port adapter II by Pro-face (Model: GP070-MD11)	RS422/485 (4wire)	Setting Example 3 (page 10)	Cable Diagram 10 (page 27)
		2-port adapter II by Pro-face (Model: GP070-MD11) + FX1N-422-BD	RS422/485 (4wire)	Setting Example 3 (page 10)	Cable Diagram 11 (page 30)

Series	CPU	Link I/F	SIO Type	Setting Example	Cable Diagram
MELSEC FX Series	FX2N	CPU Direct	RS422/485 (4wire)	Setting Example 2 (page 9)	Cable Diagram 2 (page 16)
		FX2N-232-BD	RS232C	Setting Example 1 (page 8)	Cable Diagram 3 (page 17)
		FX0N-232ADP + FX2N-CNV-BD	RS232C	Setting Example 1 (page 8)	Cable Diagram 4 (page 18)
		FX2NC-232ADP +FX2N-CNV-BD	RS232C	Setting Example 1 (page 8)	Cable Diagram 7 (page 22)
		FX2N-422-BD	RS422/485 (4wire)	Setting Example 2 (page 9)	Cable Diagram 6 (page 21)
		2-port adapter II by Pro-face (Model: GP070-MD11)	RS422/485 (4wire)	Setting Example 3 (page 10)	Cable Diagram 10 (page 27)
		2-port adapter II by Pro-face (Model: GP070-MD11) + FX2N-422-BD	RS422/485 (4wire)	Setting Example 3 (page 10)	Cable Diagram 11 (page 30)
	FX1NC, FX2NC	CPU Direct	RS422/485 (4wire)	Setting Example 2 (page 9)	Cable Diagram 2 (page 16)
		FX0N-232ADP	RS232C	Setting Example 1 (page 8)	Cable Diagram 5 (page 20)
		FX2NC-232ADP	RS232C	Setting Example 1 (page 8)	Cable Diagram 9 (page 26)
		2-port adapter II by Pro-face (Model: GP070-MD11)	RS422/485 (4wire)	Setting Example 3 (page 10)	Cable Diagram 10 (page 27)
	FX3U, FX3UC	CPU Direct	RS422/485 (4wire)	Setting Example 2 (page 9)	Cable Diagram 2 (page 16)
		FX3U-232-BD	RS232C	Setting Example 1 (page 8)	Cable Diagram 3 (page 17)
		FX3U-232ADP + FX3U-232-BD, FX3U- 422-BD, FX3U-485-BD, FX3U-USB-BD or FX3U-CNV-BD	RS232C	Setting Example 1 (page 8)	Cable Diagram 8 (page 24)
		FX3U-422-BD	RS422/485 (4wire)	Setting Example 2 (page 9)	Cable Diagram 6 (page 21)
		2-port adapter II by Pro-face (Model: GP070-MD11)	RS422/485 (4wire)	Setting Example 3 (page 10)	Cable Diagram 10 (page 27)
		2-port adapter II by Pro-face (Model: GP070-MD11) + FX3U-422-BD	RS422/485 (4wire)	Setting Example 3 (page 10)	Cable Diagram 11 (page 30)

■ COM Port of IPC

When connecting IPC with External Device, the COM port which can be used changes with series and SIO type. Please refer to the manual of IPC for details.

Usable port

Series	Usable port		
	RS-232C	RS-422/485(4 wire)	RS-422/485(2 wire)
PS-2000B	COM1 ^{*1} , COM2, COM3 ^{*1} , COM4	-	-
PS-3450A, PS-3451A	COM1, COM2 ^{*1*2}	COM2 ^{*1*2}	COM2 ^{*1*2}
PS-3650A, PS-3651A	COM1 ^{*1}	-	-
PS-3700A (Pentium®4-M) PS-3710A	COM1 ^{*1} , COM2 ^{*1} , COM3 ^{*2} , COM4	COM3 ^{*2}	COM3 ^{*2}
PS-3711A	COM1 ^{*1} , COM2 ^{*2}	COM2 ^{*2}	COM2 ^{*2}
PL-3000B	COM1 ^{*1*2} , COM2 ^{*1} , COM3, COM4	COM1 ^{*1*2}	COM1 ^{*1*2}

*1 The RI/5V can be switched. Please switch with the change switch of IPC.

*2 It is necessary to set up the SIO type with the Dip switch. Please set up as follows according to SIO type to be used.

Dip switch setting: RS-232C

Dip switch	Setting	Description
1	OFF ^{*1}	Reserve (always OFF)
2	OFF	SIO type: RS-232C
3	OFF	
4	OFF	Output mode of SD (TXD) data: Always output
5	OFF	Terminal resistance (220Ω) insertion to SD (TXD): None
6	OFF	Terminal resistance (220Ω) insertion to RD (RXD): None
7	OFF	Short-circuit of SDA (TXA) and RDA (RXA): Does not Exist
8	OFF	Short-circuit of SDB (TXB) and RDB (RXB): Does not Exist
9	OFF	RS (RTS) Auto control mode: Disable
10	OFF	

*1 It is necessary to turn ON the set value, only when using PS-3450A and PS-3451A.

Dip switch setting: RS-422/485 (4 wire)

Dip switch	Setting	Description
1	OFF	Reserve (always OFF)
2	ON	SIO type: RS-422/485
3	ON	
4	OFF	Output mode of SD (TXD) data: Always output
5	OFF	Terminal resistance (220Ω) insertion to SD (TXD): None
6	OFF	Terminal resistance (220Ω) insertion to RD (RXD): None
7	OFF	Short-circuit of SDA (TXA) and RDA (RXA): Does not Exist
8	OFF	Short-circuit of SDB (TXB) and RDB (RXB): Does not Exist
9	OFF	RS (RTS) Auto control mode: Disable
10	OFF	

Dip switch setting: RS-422/485 (2 wire)

Dip switch	Setting	Description
1	OFF	Reserve (always OFF)
2	ON	SIO type: RS-422/485
3	ON	
4	OFF	Output mode of SD (TXD) data: Always output
5	OFF	Terminal resistance (220Ω) insertion to SD (TXD): None
6	OFF	Terminal resistance (220Ω) insertion to RD (RXD): None
7	ON	Short-circuit of SDA (TXA) and RDA (RXA): Exist
8	ON	Short-circuit of SDB (TXB) and RDB (RXB): Exist
9	ON	RS (RTS) Auto control mode: Enable
10	ON	

2 Selection of External Device

Select the External Device to be connected to the Display.

Setup Items	Setup Description
Maker	Select the maker of the External Device to be connected. Select "Mitsubishi Electric Corporation".
Driver	Select a model (series) of the External Device to be connected and connection method. Select "FX Series CPU Direct". Check the External Device which can be connected in "FX Series CPU Direct" in system configuration. ☞ "1 System Configuration" (page 3)
Use System Area	Check this option when you synchronize the system data area of Display and the device (memory) of External Device. When synchronized, you can use the ladder program of External Device to switch the display or display the window on the display. Cf. GP-Pro EX Reference Manual "Appendix 1.4 LS Area (only for direct access method)" This can be also set with GP-Pro EX or in off-line mode of Display. Cf. GP-Pro EX Reference Manual " 5.14.6 Setting Guide of [System Setting Window]■[Main Unit Settings] Settings Guide◆System Area Setting" Cf. Maintenance/Troubleshooting "2.14.1 Settings common to all Display models◆System Area Settings"
Port	Select the Display port to be connected to the External Device.

3 Example of Communication Setting

Examples of communication settings of the Display and the External Device, recommended by Pro-face, are shown.

3.1 Setting Example 1

■ Setting of GP-Pro EX

◆ Communication Settings

To display the setting screen, select [Device/PLC Settings] from [System setting window] in workspace.

Device/PLC 1

Summary [Change Device/PLC](#)

Maker Series Port

Text Data Mode [Change](#)

Communication Settings

RS232C RS422/485(2wire) RS422/485(4wire)

Speed

Data Length 7 8

Parity NONE EVEN ODD

Stop Bit 1 2

Flow Control NONE ER(DTR/CTS) XON/XOFF

Timeout (sec)

Retry

Wait To Send (ms)

Adapter Direct 2 Port

RI / VCC RI VCC

In the case of RS232C, you can select the 9th pin to RI (Input) or VCC (5V Power Supply). If you use the Digital's RS232C Isolation Unit or CPU I/F Cable for Mitsubishi PLC FX Series (Digital's:GP430-HP11-0), please select it to VCC.

Device-Specific Settings

Allowable No. of Device/PLCs 1 Unit(s)

No.	Device Name	Settings
1	PLC1	

■ Setting of External Device

Settings of External Device are not necessary.

◆ Notes

- When using the function extension board, store data "0" in D8120. Also, be sure to store data "0" between D8173 and D8180. Then, set M8070 and M8071 to OFF. When using channel 2 for FX3U or FX3UC, store data "0" in D8420 instead of D8120.

3.2 Setting Example 2

■ Setting of GP-Pro EX

◆ Communication Settings

To display the setting screen, select [Device/PLC Settings] from [System setting window] in workspace.

Device/PLC 1

Summary [Change Device/PLC](#)

Maker Series Port

Text Data Mode [Change](#)

Communication Settings

SIO Type RS232C RS422/485(2wire) RS422/485(4wire)

Speed

Data Length 7 8

Parity NONE EVEN ODD

Stop Bit 1 2

Flow Control NONE ER(DTR/CTS) XON/XOFF

Timeout (sec)

Retry

Wait To Send (ms)

Adapter Direct 2 Port

RI / VCC RI VCC

In the case of RS232C, you can select the 9th pin to RI (Input) or VCC (5V Power Supply). If you use the Digital's RS232C Isolation Unit or CPU I/F Cable for Mitsubishi PLC FX Series (Digital's:GP4304P11-0), please select it to VCC.

Device-Specific Settings

Allowable No. of Device/PLCs 1 Unit(s)

No.	Device Name	Settings
1	PLC1	<input type="button" value="Settings"/>

■ Setting of External Device

Settings of External Device are not necessary.

◆ Notes

- When using the function extension board, store data "0" in D8120. Also, be sure to store data "0" between D8173 and D8180. Then, set M8070 and M8071 to OFF. When using channel 2 for FX3U or FX3UC, store data "0" in D8420 instead of D8120.

3.3 Setting Example 3

■ Setting of GP-Pro EX

◆ Communication Settings

To display the setting screen, select [Device/PLC Settings] from [System setting window] in workspace.

Device/PLC 1

Summary [Change Device/PLC](#)

Maker Series Port

Text Data Mode [Change](#)

Communication Settings

SIO Type RS232C RS422/485(2wire) RS422/485(4wire)

Speed

Data Length 7 8

Parity NONE EVEN ODD

Stop Bit 1 2

Flow Control NONE ER(DTR/CTS) XON/XOFF

Timeout (sec)

Retry

Wait To Send (ms)

Adapter Direct 2 Port

RI / VCC RI VCC

In the case of RS232C, you can select the 9th pin to RI (Input) or VCC (5V Power Supply). If you use the Digital's RS232C Isolation Unit or CPU I/F Cable for Mitsubishi PLC FX Series (Digital's:GP4304P11-0), please select it to VCC.

Device-Specific Settings

Allowable No. of Device/PLCs 1 Unit(s)

No.	Device Name	Settings
1	PLC1	<input type="button" value="Settings"/>

■ Setting of External Device

Settings of External Device are not necessary.

◆ Notes

- When using the function extension board, store data "0" in D8120. Also, be sure to store data "0" between D8173 and D8180. Then, set M8070 and M8071 to OFF. When using channel 2 for FX3U or FX3UC, store data "0" in D8420 instead of D8120.

4 Setup Items

Set communication settings of the Display with GP-Pro EX or in off-line mode of the Display.

The setting of each parameter must be identical to that of External Device.

 "3 Example of Communication Setting" (page 8)

4.1 Setup Items in GP-Pro EX

■ Communication Settings

To display the setting screen, select [Device/PLC Settings] from [System setting window] in workspace.

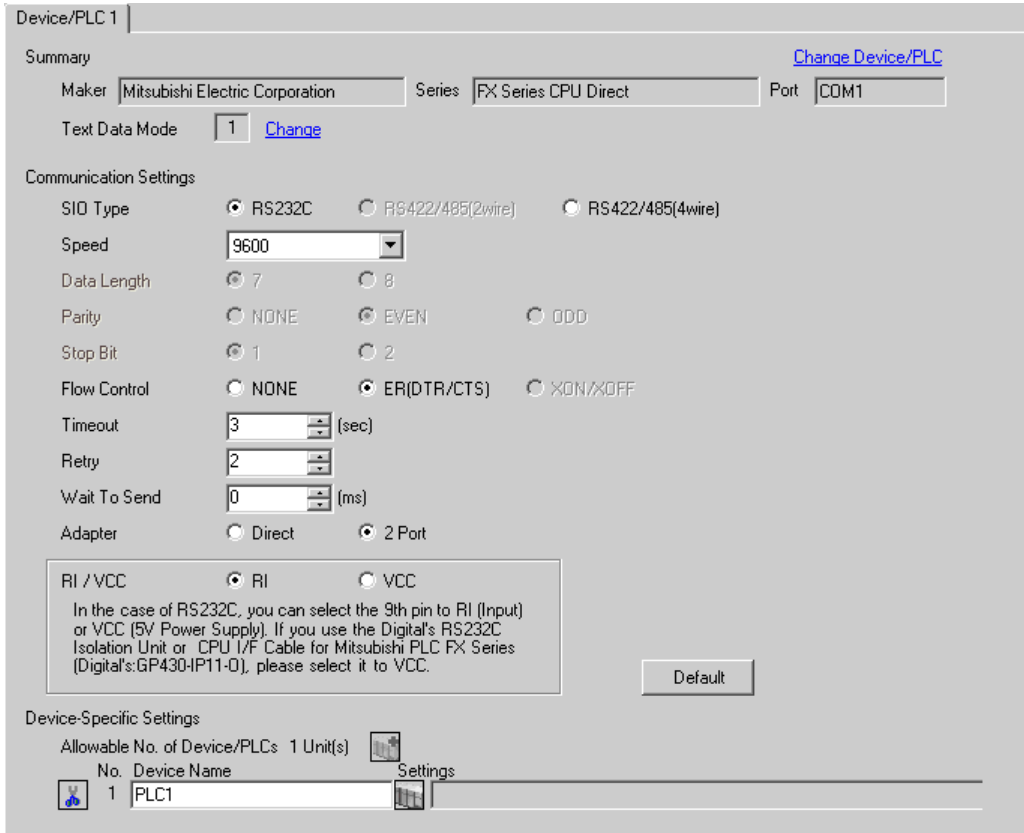

Device/PLC 1

Summary [Change Device/PLC](#)

Maker Series Port

Text Data Mode [Change](#)

Communication Settings

SIO Type RS232C RS422/485(2wire) RS422/485(4wire)

Speed

Data Length 7 8

Parity NONE EVEN ODD

Stop Bit 1 2

Flow Control NONE ER(DTR/CTS) XON/XOFF

Timeout (sec)

Retry

Wait To Send (ms)

Adapter Direct 2 Port

RI / VCC RI VCC

In the case of RS232C, you can select the 9th pin to RI (Input) or VCC (5V Power Supply). If you use the Digital's RS232C Isolation Unit or CPU I/F Cable for Mitsubishi PLC FX Series (Digital's:GP430-IP11-0), please select it to VCC.

Device-Specific Settings

Allowable No. of Device/PLCs 1 Unit(s)

No.	Device Name	Settings
1	PLC1	<input type="button" value="Settings"/>

Setup Items	Setup Description
SIO Type	Select the SIO type to communicate with the External Device.
Speed	Select speed between External Device and Display. NOTE <ul style="list-style-type: none"> Supported range of speed varies depending on the type. FX3U and FX3UC support up to 115.2K. FX1N, FX1NC, FX2N and FX2NC support up to 38400. Note that they support up to 19200 when using FX-232W or FX232AWC. Other CPUs support up to 9600.
Data Length	Select data length.
Parity	Select how to check parity.
Stop Bit	Select stop bit length.

Setup Items	Setup Description
Flow Control	Select the communication control method to prevent overflow of transmission and reception data.
Timeout	Use an integer from 1 to 127 to enter the time (s) for which the Display waits for the response from the External Device.
Retry	In case of no response from the External Device, use an integer from 0 to 255 to enter how many times the Display retransmits the command.
Wait To Send	Use an integer from 0 to 255 to enter standby time (ms) for the Display from receiving packets to transmitting next commands.
Adapter	Select "Direct" or "2 Port " for the adapter to be used. When using 2-port adapter II, select "2 Port".
RI/VCC	You can switch RI/VCC of the 9th pin when you select RS232C for SIO type. It is necessary to change RI/5V by changeover switch of IPC when connect with IPC. Please refer to the manual of the IPC for more detail.

4.2 Setup Items in Off-Line Mode

- NOTE** • Please refer to Maintenance/Troubleshooting for more information on how to enter off-line mode or about operation.
Cf. Maintenance/Troubleshooting "2.2 Offline Mode"

■ Communication Settings

To display the setting screen, touch [Device/PLC Settings] from [Peripheral Settings] in off-line mode. Touch the External Device you want to set from the displayed list.

(Page 1/2)

Comm.				
FX Series CPU Direct		[COM1]	Page 1/2	
SIO Type	RS232C			
Speed	9600			
Data Length	7			
Parity	EVEN			
Stop Bit	1			
Flow Control	ER(DTR/CTS)			
Timeout(s)		3	▼	▲
Retry		2	▼	▲
Wait To Send(ms)		0	▼	▲
Adapter	2 Port			
				➔
Exit		Back		2005/09/02 12:32:59

Setup Items	Setup Description
SIO Type	<p>Select the SIO type to communicate with the External Device.</p> <p>IMPORTANT</p> <p>To make the communication settings correctly, confirm the serial interface specifications of Display unit for [SIO Type]. We cannot guarantee the operation if a communication type that the serial interface does not support is specified. For details concerning the serial interface specifications, refer to the manual for Display unit.</p>
Speed	<p>Select speed between External Device and Display.</p> <p>NOTE</p> <ul style="list-style-type: none"> Supported range of speed varies depending on the type. FX3U and FX3UC support up to 115.2K. FX1N, FX1NC, FX2N and FX2NC support up to 38400. Note that they support up to 19200 when using FX-232W or FX232AWC. Other CPUs support up to 9600.
Data Length	Select data length.
Parity	Select how to check parity.
Stop Bit	Select stop bit length.

Setup Items	Setup Description
Flow Control	Select the communication control method to prevent overflow of transmission and reception data.
Timeout	Use an integer from 1 to 127 to enter the time (s) for which the Display waits for the response from the External Device.
Retry	In case of no response from the External Device, use an integer from 0 to 255 to enter how many times the Display retransmits the command.
Wait To Send	Use an integer from 0 to 255 to enter standby time (ms) for the Display from receiving packets to transmitting next commands.
Adapter	Select "Direct" or "2 Port " for the adapter to be used. When using 2-port adapter II, select "2 Port".

(Page 2/2)

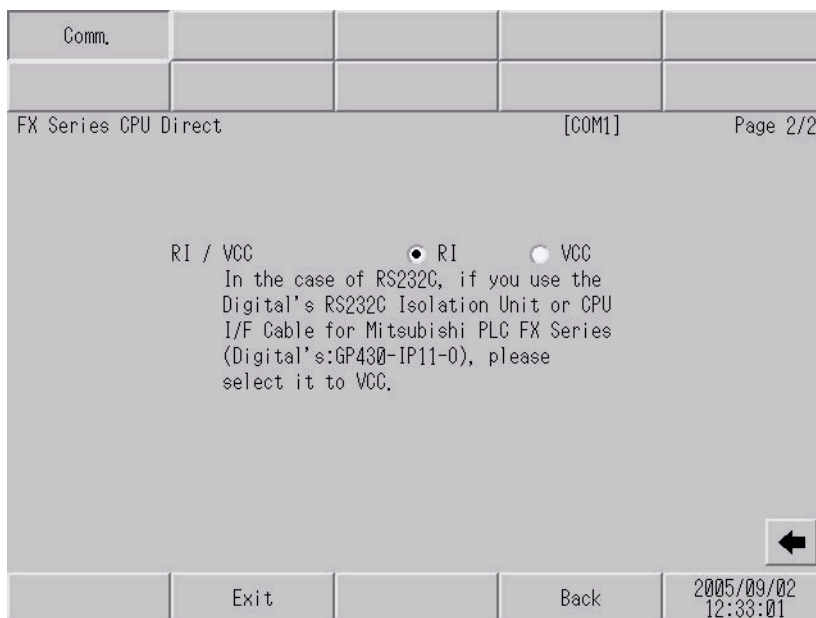

Setup Items	Setup Description
RI/VCC	You can switch RI/VCC of the 9th pin when you select RS232C for SIO type. It is necessary to change RI/5V by changeover switch of IPC when connect with IPC. Please refer to the manual of the IPC for more detail.

5 Cable Diagram

The cable diagram shown below may be different from the cable diagram recommended by Mitsubishi Electric Corp. Please be assured there is no operational problem in applying the cable diagram shown in this manual.

- The FG pin of the External Device body must be D-class grounded. Please refer to the manual of the External Device for more details.
- SG and FG are connected inside the Display. When connecting SG to the External Device, design the system not to form short-circuit loop.
- Connect the isolation unit, when communication is not stabilized under the influence of a noise etc..

Cable Diagram 1

Display (Connection Port)	Cable	Notes
GP (COM1) IPC*1 PC/AT	9-25 232C conversion cable by Pro-face CA3-CBLCBT232-01 (0.2m) + Mitsubishi PLC FX Series program control I/F cable by Pro-face GP430-IP11-O (5m)	

*1 Only the COM port which can communicate by RS-232C can be used.

- ☞ ■ COM Port of IPC (page 5)

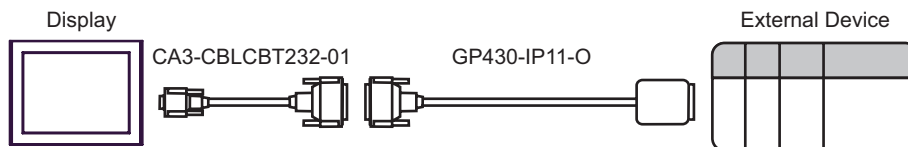

Cable Diagram 2

Display (Connection Port)	Cable	Notes
GP*1 (COM1) AGP-3302B (COM2) IPC*2	Mitsubishi FX connection cable by Pro-face CA3-CBLFX/1M-01 (1m) or CA3-CBLFX/5M-01 (5m)	

*1 All GP models except AGP-3302B

*2 Only the COM port which can communicate by RS-422/485 (4 wire) can be used.

☞ ■ COM Port of IPC (page 5)

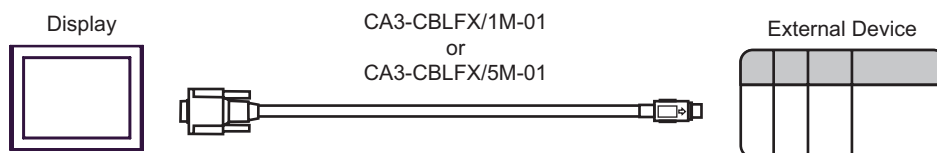

Cable Diagram 3

Display (Connection Port)	Cable		Notes
GP (COM1) IPC*1 PC/AT	A	RS232C communication cable by Mitsubishi Electric Corp. FX-232CAB-1 (3m) + Function extension board by Mitsubishi Electric Corp.*2 FX1N-232-BD, FX2N-232-BD or FX3U-232-BD	
	B	Your own cable + Function extension board by Mitsubishi Electric Corp.*2 FX1N-232-BD, FX2N-232-BD or FX3U-232-BD	The cable length must be 15m or less.

*1 Only the COM port which can communicate by RS-232C can be used.

☞ ■ COM Port of IPC (page 5)

*2 Supported function extension boards vary depending on the model.

CPU	Function Extension Board
FX1S, FX1N	FX1N-232-BD
FX2N	FX2N-232-BD
FX3U, FX3UC	FX3U-232-BD

A) When using the RS232C communication cable by Mitsubishi Electric Corp. (FX-232CAB-1) and the function extension board (FX1N-232-BD, FX2N-232-BD or FX3U-232-BD) by Mitsubishi Electric Corp.

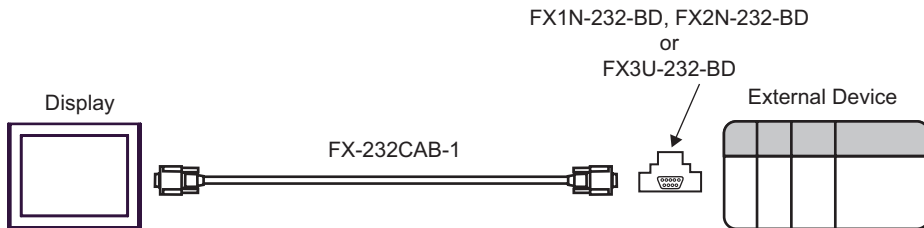

B) When using your own cable and the function extension board (FX1N-232-BD, FX2N-232-BD or FX3U-232-BD) by Mitsubishi Electric Corp.

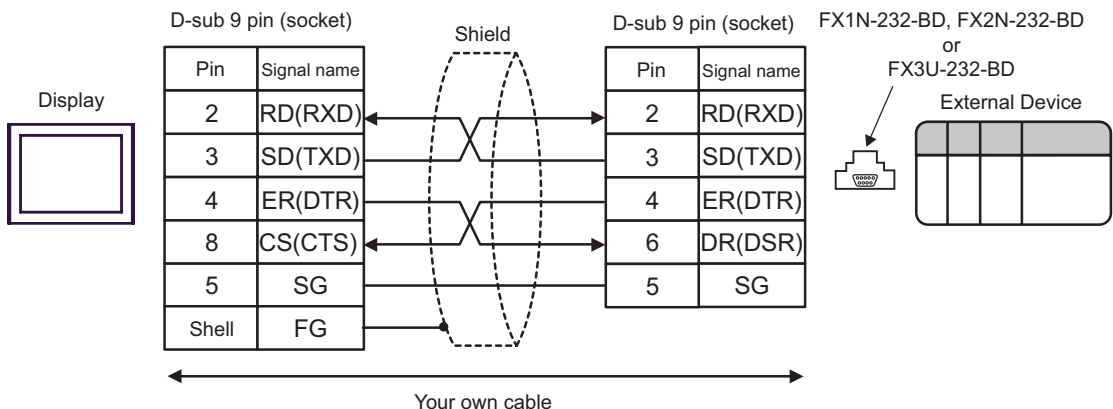

Cable Diagram 4

Display	Cable	Notes
GP (COM1) IPC*1 PC/AT	A RS-232C cable by Pro-face CA3-CBL232/5M-01 (5m) + Communication adapter by Mitsubishi Electric Corp. FX0N-232ADP + Function extension board by Mitsubishi Electric Corp.*2 FX1N-CNV-BD or FX2N-CNV-BD	
	B Your own cable + Communication adapter by Mitsubishi Electric Corp. FX0N-232ADP + Function extension board by Mitsubishi Electric Corp.*2 FX1N-CNV-BD or FX2N-CNV-BD	The cable length must be 15m or less.

*1 Only the COM port which can communicate by RS-232C can be used.

☞ ■ COM Port of IPC (page 5)

*2 Supported function extension boards vary depending on the model.

CPU	Function Extension Board
FX1S, FX1N	FX1N-CNV-BD
FX2N	FX2N-CNV-BD

A) When using the RS-232C cable (CA3-CBL232/5M-01) by Pro-face, the communication adapter (FX0N-232ADP) by Mitsubishi Electric Corp. and the function extension board (FX1N-CNV-BD or FX2N-CNV-BD) by Mitsubishi Electric Corp.

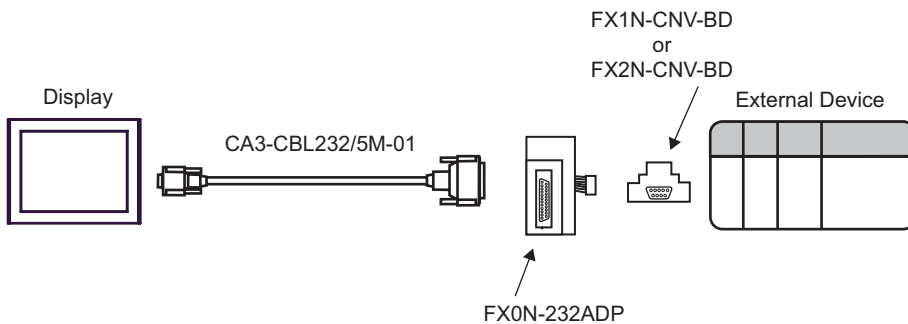

B) When using your own cable, the communication adapter (FX0N-232ADP) by Mitsubishi Electric Corp. and the function extension board (FX1N-CNV-BD or FX2N- CNV-BD) by Mitsubishi Electric Corp.

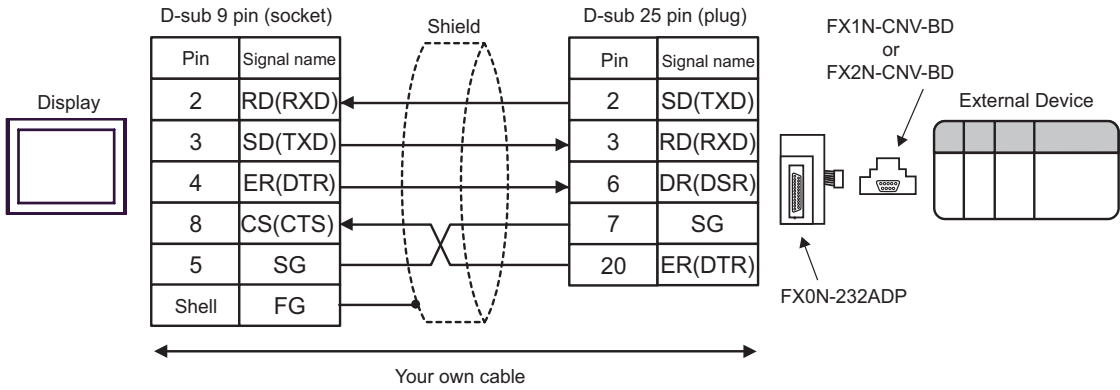

Cable Diagram 5

Display (Connection Port)	Cable	Notes
GP (COM1) IPC*1 PC/AT	A RS-232C cable by Pro-face CA3-CBL232/5M-01 (5m) + Communication adapter by Mitsubishi Electric Corp. FX0N-232ADP	
	B Your own cable + Communication adapter by Mitsubishi Electric Corp. FX0N-232ADP	The cable length must be 15m less.

*1 Only the COM port which can communicate by RS-232C can be used.

☞ ■ COM Port of IPC (page 5)

A) When using the RS-232C cable by Pro-face (CA3-CBL232/5M-01) and the communication adapter (FX0N-232ADP) by Mitsubishi Electric Corp.

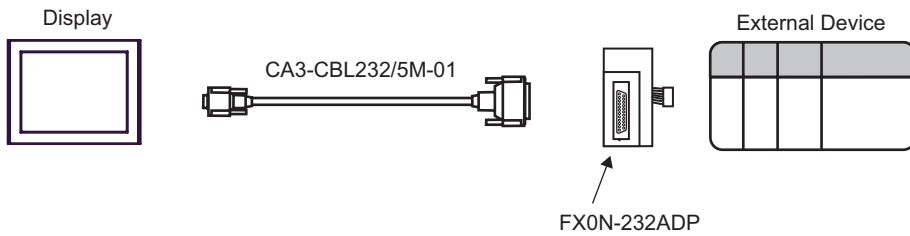

B) When using your own cable and the communication adapter (FX0N-232ADP) by Mitsubishi Electric Corp.

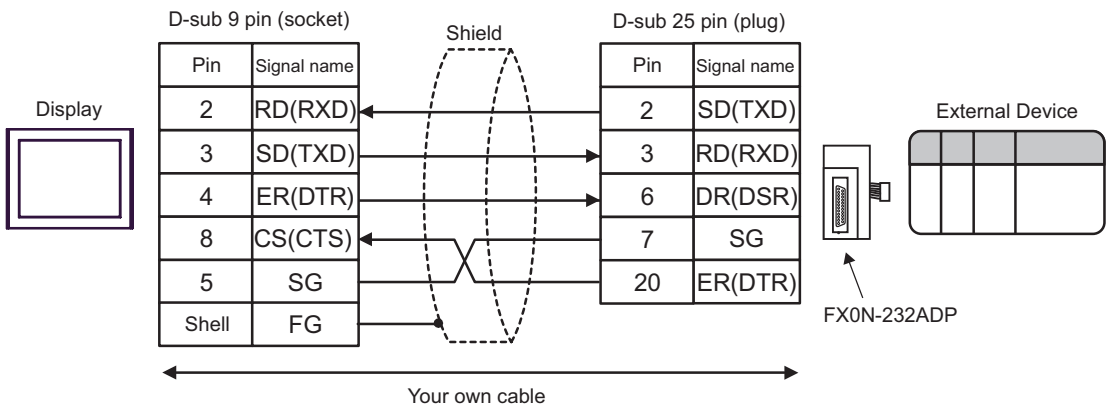

Cable Diagram 6

Display (Connection Port)	Cable	Notes
GP*1 (COM1) AGP-3302B (COM2) IPC*2	Mitsubishi FX connection cable by Pro-face CA3-CBLFX/1M-01 (1m) or CA3-CBLFX/5M-01 (5m) + Function extension board by Mitsubishi Electric Corp.*3 FX1N-422-BD, FX2N-422-BD or FX3U-422-BD	

*1 All GP models except AGP-3302B

*2 Only the COM port which can communicate by RS-422/485 (4 wire) can be used.

☞ ■ COM Port of IPC (page 5)

*3 Supported function extension boards vary depending on the model.

CPU	Function Extension Board
FX1S, FX1N	FX1N-422-BD
FX2N	FX2N-422-BD
FX3U, FX3UC	FX3U-422-BD

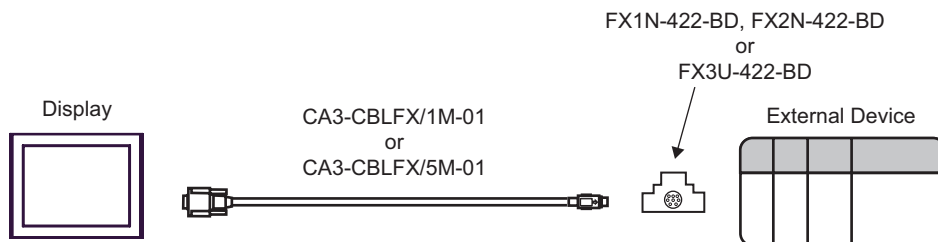

Cable Diagram 7

Display (Connection Port)	Cable		Notes
GP (COM1) IPC*1 PC/AT	A	RS232C communication cable by Mitsubishi Electric Corp. FX-232CAB-1 (3m) + Communication adapter by Mitsubishi Electric Corp. FX2NC-232ADP + Function extension board by Mitsubishi Electric Corp.*2 FX1N-CNV-BD or FX2N-CNV-BD	
	B	Your own cable + Communication adapter by Mitsubishi Electric Corp. FX2NC-232ADP + Function extension board by Mitsubishi Electric Corp.*2 FX1N-CNV-BD or FX2N-CNV-BD	The cable length must be 15m or less.

*1 Only the COM port which can communicate by RS-232C can be used.

☞ ■ COM Port of IPC (page 5)

*2 Supported function extension boards vary depending on the model.

CPU	Function Extension Board
FX1S, FX1N	FX1N-CNV-BD
FX2N	FX2N-CNV-BD

A) When using the RS232C communication cable (FX-232CAB-1), the communication adapter (FX2NC-232ADP) by Mitsubishi Electric Corp. and the function extension board (FX1N-CNV-BD or FX2N-CNV-BD) by Mitsubishi Electric Corp.

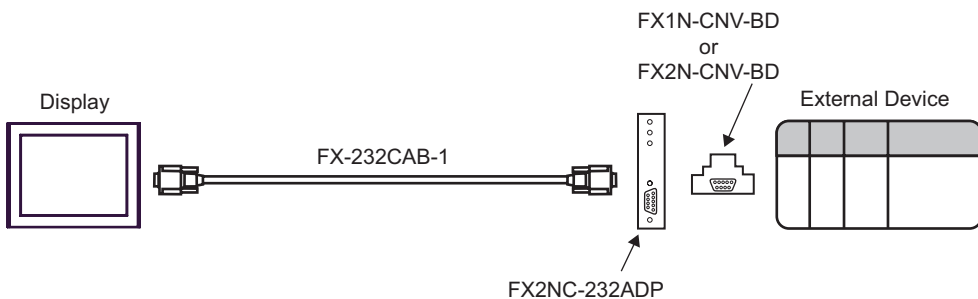

B) When using your own cable, the communication adapter (FX2NC-232ADP) by Mitsubishi Electric Corp. and the function extension board (FX1N-CNV-BD or FX2N- CNV-BD) by Mitsubishi Electric Corp.

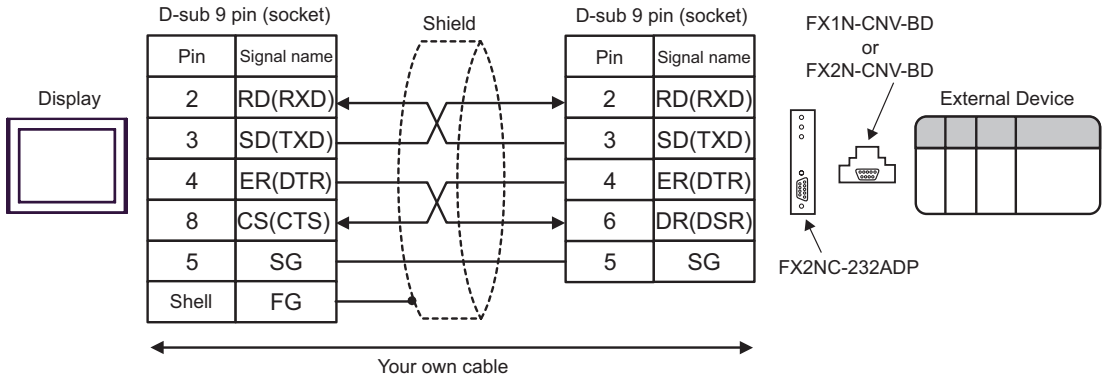

Cable Diagram 8

Display (Connection Port)	Cable	Notes
GP (COM1) IPC*1 PC/AT	RS232C communication cable by Mitsubishi Electric Corp. FX-232CAB-1 (3m) + Communication adapter by Mitsubishi Electric Corp. FX3U-232ADP + Function extension board by Mitsubishi Electric Corp. FX3U-232-BD, FX3U-422-BD, FX3U-485-BD, FX3U-USB-BD or FX3U-CNV-BD	
	Your own cable + Communication adapter by Mitsubishi Electric Corp. FX3U-232ADP + Function extension board by Mitsubishi Electric Corp. FX3U-232-BD, FX3U-422-BD, FX3U-485-BD, FX3U-USB-BD or FX3U-CNV-BD	The cable length must be 15m or less.

*1 Only the COM port which can communicate by RS-232C can be used.

 ■ COM Port of IPC (page 5)

A) RS232C communication cable (FX-232CAB-1) by Mitsubishi Electric Corp., the communication adapter (FX3U-232ADP) by Mitsubishi Electric Corp. and the function extension board (FX3U-232-BD, FX3U-422-BD, FX3U-485-BD, FX3U-USB-BD or FX3U-CNV-BD) by Mitsubishi Electric Corp.

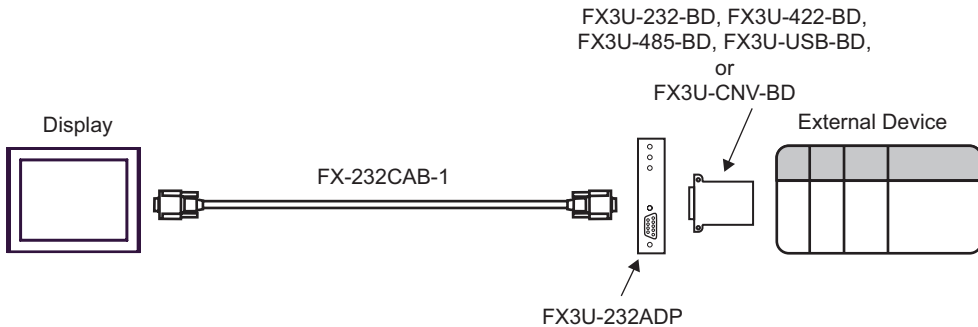

B) When using your own cable, the communication adapter (FX3U-232ADP) by Mitsubishi Electric Corp. and the function extension board (FX3U-232-BD, FX3U-422-BD, FX3U-485-BD, FX3U-USB-BD or FX3U-CNV-BD) by Mitsubishi Electric Corp.

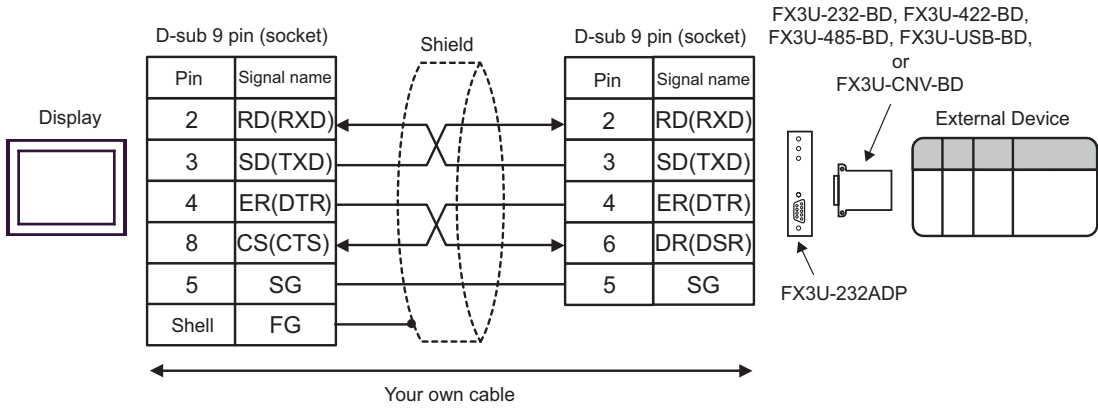

Cable Diagram 9

Display (Connection Port)	Cable		Notes
GP (COM1) IPC*1 PC/AT	A	RS232C communication cable by Mitsubishi Electric Corp. FX-232CAB-1 (3m) + Communication adapter by Mitsubishi Electric Corp. FX2NC-232ADP	
	B	Your own cable + Communication adapter by Mitsubishi Electric Corp. FX2NC-232ADP	The cable length must be 15m or less.

*1 Only the COM port which can communicate by RS-232C can be used.

 ■ COM Port of IPC (page 5)

A) When using the RS232C communication cable (FX-232CAB-1) by Mitsubishi Electric Corp. and the communication adapter (FX2NC-232ADP) by Mitsubishi Electric Corp.

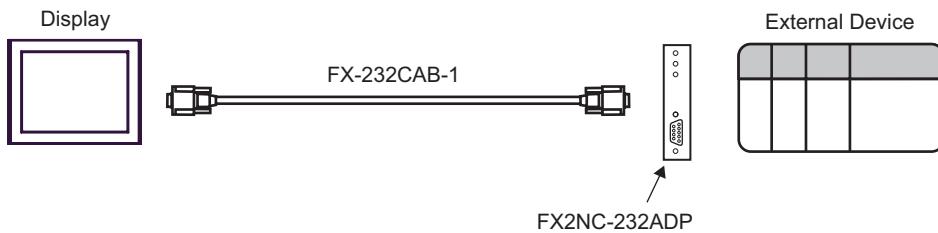

B) When using your own cable and the communication adapter (FX2NC-232ADP) by Mitsubishi Electric Corp.

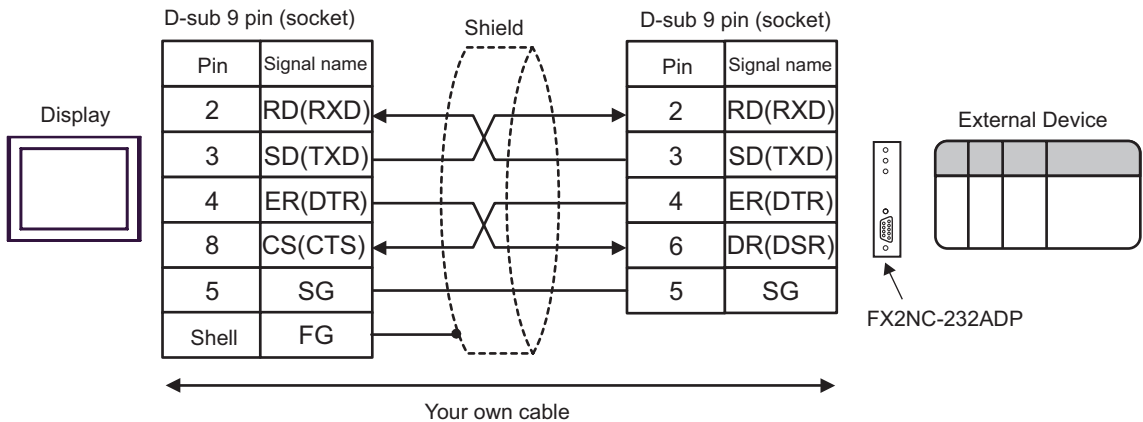

Cable Diagram 10

Display (Connection Port)	Cable		Notes
GP*1 (COM1) AGP-3302B (COM2) IPC*2	A	COM port conversion adapter by Pro-face CA3-ADPCOM-01 + 2-port adapter cable for AGP by Pro-face CA3-MDCB11 (5m) + 2-port adapter II by Pro-face GP070-MD11 + Connector conversion cable by Mitsubishi Electric Corp.*3 FX-20P-CADP (0.3m)	
	B	Your own cable + 2-port adapter II by Pro-face GP070-MD11 + Connector conversion cable by Mitsubishi Electric Corp.*3 FX-20P-CADP (0.3m)	The cable length must be 600m or less.
GP*4 (COM2)	C	Online adapter by Pro-face CA4-ADPONL-01 + 2-port adapter cable for AGP by Pro-face CA3-MDCB11 (5m) + 2-port adapter II by Pro-face GP070-MD11 + Connector conversion cable by Mitsubishi Electric Corp.*3 FX-20P-CADP (0.3m)	
	D	Online adapter by Pro-face CA4-ADPONL-01 + Your own cable + 2-port adapter II by Pro-face GP070-MD11 + Connector conversion cable by Mitsubishi Electric Corp.*3 FX-20P-CADP (0.3m)	The cable length must be 600m or less.

*1 All GP models except AGP-3302B

*2 Only the COM port which can communicate by RS-422/485 (4 wire) can be used.

 ■ COM Port of IPC (page 5)

*3 For FX2, the connector conversion cable (FX-20P-CADP) by Mitsubishi Electric Corp. is not necessary.

*4 All GP models except GP-3200 series and AGP-3302B

A) When using the COM port conversion adapter (CA3-ADPCOM-01) by Pro-face, the 2-port adapter cable for AGP (CA3-MDCB11) by Pro-face, the 2-port adapter II (GP070-MD11) by Pro-face, and the connector conversion cable (FX-20P-CADP) by Mitsubishi Electric Corp.

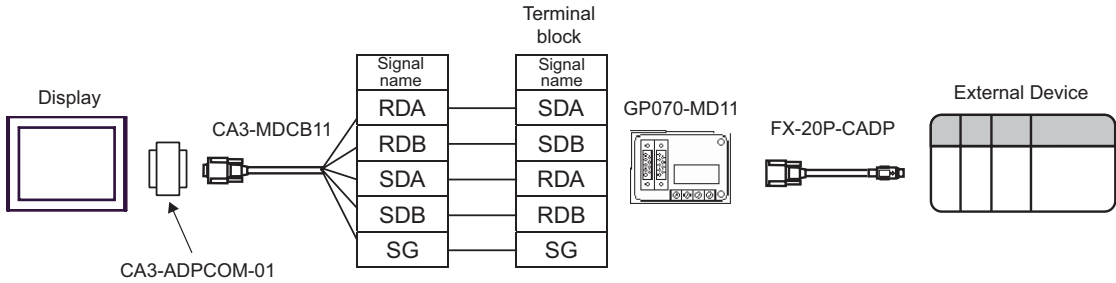

B) When using your own cable, the 2-port adapter II (GP070-MD11) by Pro-face and the connector conversion cable (FX-20P-CADP) by Mitsubishi Electric Corp.

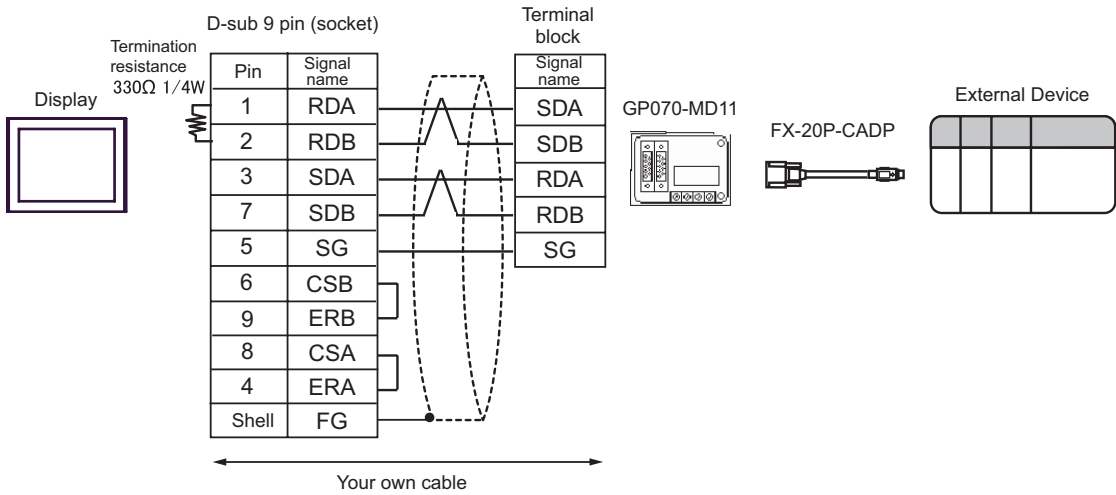

C) When using the online adapter (CA4-ADPONL-01) by Pro-face, the 2-port adapter cable for AGP (CA3-MDCB11) by Pro-face, the 2-port adapter II (GP070-MD11) by Pro-face, and the connector conversion cable (FX-20P-CADP) by Mitsubishi Electric Corp.

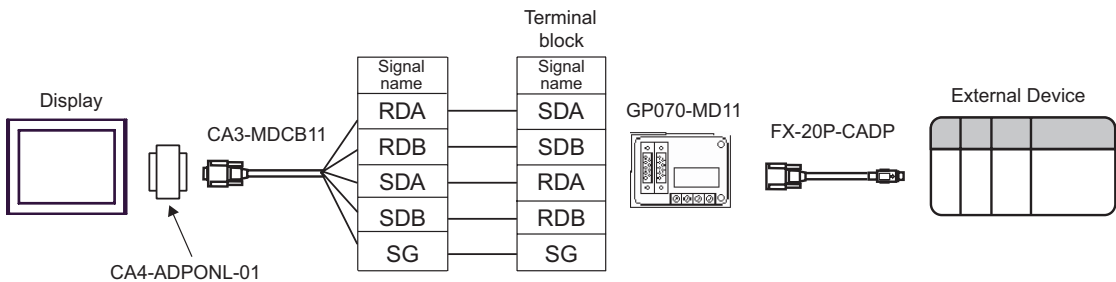

D) When using the online adapter (CA4-ADPONL-01) by Pro-face, your own cable, the 2-port adapter II (GP070-MD11) by Pro-face, and the connector conversion cable (FX-20P-CADP) by Mitsubishi Electric Corp.

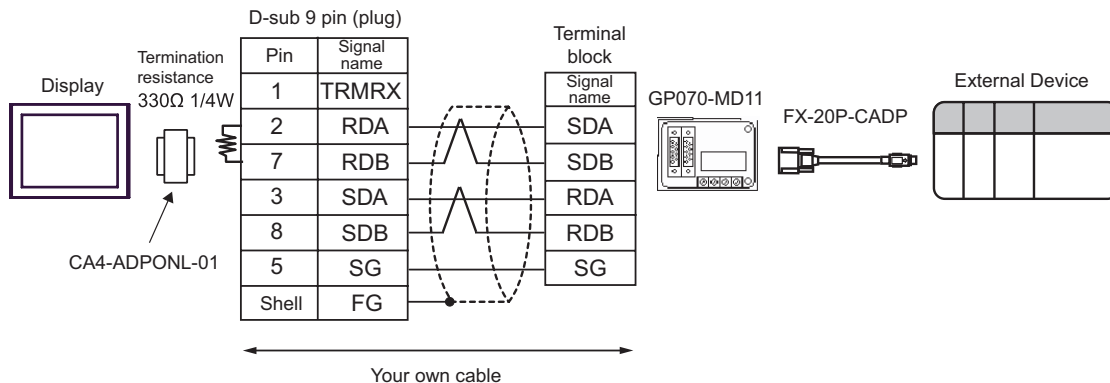

Cable Diagram 11

Display (Connection Port)	Cable	Notes
GP* ¹ (COM1) AGP-3302B (COM2) IPC* ²	<p style="text-align: center;">A</p> <p style="text-align: center;">COM port conversion adapter by Pro-face CA3-ADPCOM-01 + 2-port adapter cable for AGP by Pro-face CA3-MDCB11 (5m) + 2-port adapter II by Pro-face GP070-MD11 + Connector conversion cable by Mitsubishi Electric Corp. FX-20P-CADP (0.3m) + Function extension board by Mitsubishi Electric Corp. *³ FX1N-422-BD, FX2N-422-BD, or FX3U-422-BD</p>	
	<p style="text-align: center;">B</p> <p style="text-align: center;">Your own cable + 2-port adapter II by Pro-face GP070-MD11 + Connector conversion cable by Mitsubishi Electric Corp. FX-20P-CADP (0.3m) + Function extension board by Mitsubishi Electric Corp. *³ FX1N-422-BD, FX2N-422-BD, or FX3U-422-BD</p>	<p>The cable length must be 600m or less.</p>

continued to next page

Display (Connection Port)	Cable		Notes
GP*4 (COM2)	C	Online adapter by Pro-face CA4-ADPONL-01 + 2-port adapter cable for AGP by Pro-face CA3-MDCB11 (5m) + 2-port adapter II by Pro-face GP070-MD11 + Connector conversion cable by Mitsubishi Electric Corp. FX-20P-CADP (0.3m) + Function extension board by Mitsubishi Electric Corp.*3 FX1N-422-BD, FX2N-422-BD, or FX3U-422-BD	
	D	Online adapter by Pro-face CA4-ADPONL-01 + Your own cable + 2-port adapter II by Pro-face GP070-MD11 + Connector conversion cable by Mitsubishi Electric Corp. FX-20P-CADP (0.3m) + Function extension board by Mitsubishi Electric Corp.*3 FX1N-422-BD, FX2N-422-BD, or FX3U-422-BD	The cable length must be 600m or less.

*1 All GP models except AGP-3302B

*2 Only the COM port which can communicate by RS-422/485 (4 wire) can be used.
 ■ COM Port of IPC (page 5)

*3 Supported function extension boards vary depending on the model.

CPU	Function Extension Board
FX1S, FX1N	FX1N-422-BD
FX2N	FX2N-422-BD
FX3U, FX3UC	FX3U-422-BD

*4 All GP models except GP-3200 series and AGP-3302B

A) When using the COM port conversion adapter (CA3-ADPCOM-01) by Pro-face, the 2-port adapter cable for AGP (CA3-MDCB11) by Pro-face, the 2-port adapter II (GP070-MD11) by Pro-face, the connector conversion cable (FX-20P-CADP) by Mitsubishi Electric Corp. and the function extension board (FX1N-422-BD, FX2N-422-BD or FX3U-422-BD) by Mitsubishi Electric Corp.

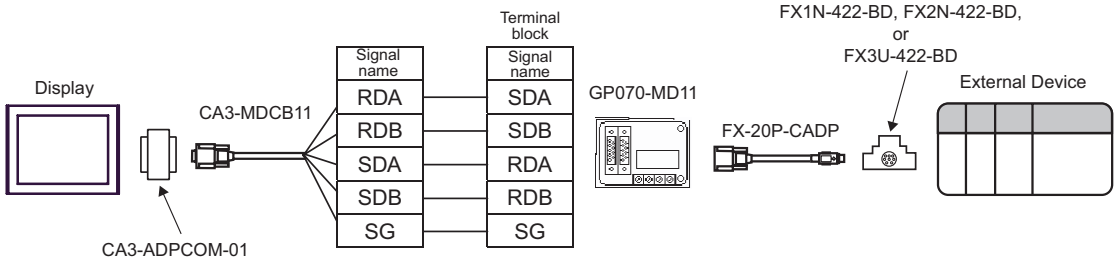

B) When using your own cable, the 2-port adapter II (GP070-MD11) by Pro-face, the connector conversion cable (FX-20P-CADP) by Mitsubishi Electric Corp., and the function extension board (FX1N-422-BD, FX2N-422-BD or FX3U-422-BD) by Mitsubishi Electric Corp.

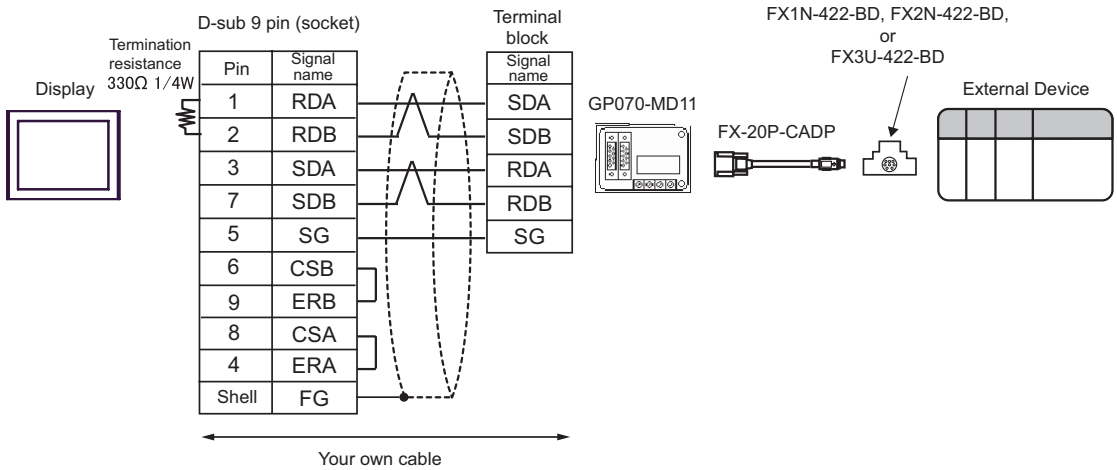

C) When using the online adapter (CA4-ADPONL-01) by Pro-face, the 2-port adapter cable for AGP (CA3-MDCB11) by Pro-face, the 2-port adapter II (GP070-MD11) by Pro-face, the connector conversion cable (FX-20P-CADP) by Mitsubishi Electric Corp. and the function extension board (FX1N-422-BD, FX2N-422-BD or FX3U-422-BD) by Mitsubishi Electric Corp.

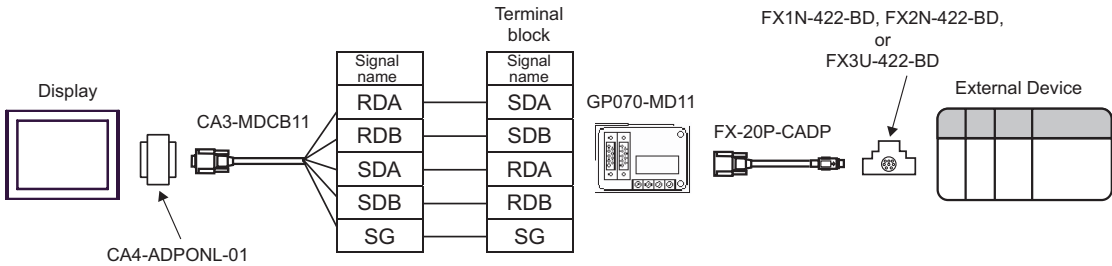

D) When using the online adapter (CA4-ADPONL-01) by Pro-face, your own cable, the 2-port adapter II (GP070-MD11) by Pro-face, the connector conversion cable (FX-20P-CADP) by Mitsubishi Electric Corp. and the function extension board (FX1N-422-BD, FX2N-422-BD or FX3U-422-BD) by Mitsubishi Electric Corp.

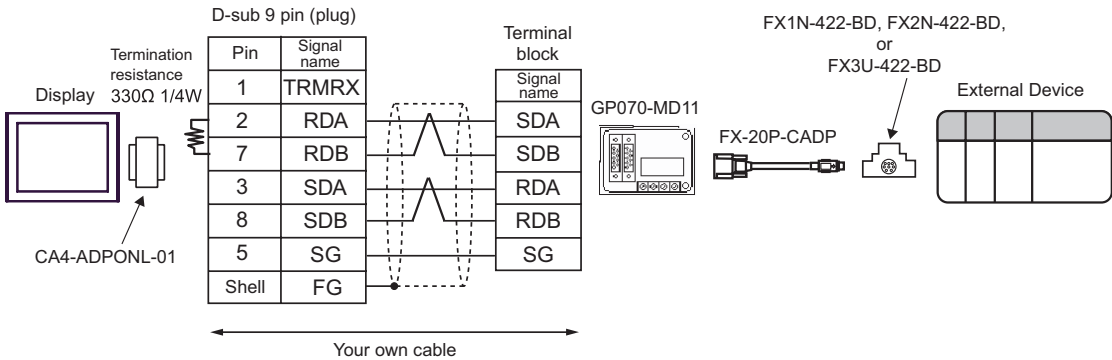







6 Supported Device

Range of supported device address is shown in the table below. Please note that the actually supported range of the devices varies depending on the External Device to be used. Please check the actual range in the manual of your connecting equipment.

6.1 When using FX1

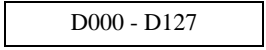
 This address can be specified as system data area.

Device	Bit Address	Word Address	32bits	Notes
Input Relay	X000 - X167	X000 - X160	[L/H]	 *1
Output Relay	Y000 - Y167	Y000 - Y160		
Internal Relay	M0000 - M1023	M0000 - M1008		
Special Auxiliary Relay	M8000 - M8255	M8000 - M8240		 *2
State	S0000 - S0999	S0000 - S0992		
Timer (Contact)	TS000 - TS245	-----		*3
Counter (Contact)	CS000 - CS135 CS200 - CS255	-----		*3
Timer (Current Value)	-----	TN000 - TN245		
Counter (Current Value)	-----	CN000 - CN135		
Counter (Current Value)	-----	CN235 - CN255		*4
Data Register	-----	 D000 - D127		
Special Data Register	-----	D8000 - D8069		 *2

*1 Includes an area in which you cannot write.

*2 Special area. This area may be used by the system, and includes an area in which you cannot write. Please refer to the manual attached to the External Device for more detail.

*3 Write disable







*4 32-bit device.

NOTE

- Please refer to the GP-Pro EX Reference Manual for system data area.
Cf. GP-Pro EX Reference Manual "Appendix 1.4 LS Area (only for direct access method)"
- Please refer to the precautions on manual notation for icons in the table.
 "Manual Symbols and Terminology"

6.2 When using FX2, FX2C, FX0N, FX0S

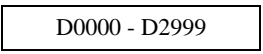
 This address can be specified as system data area.

Device	Bit Address	Word Address	32bits	Notes
Input Relay	X000 - X337	X000 - X320	[L/H]	 *1
Output Relay	Y000 - Y337	Y000 - Y320		
Internal Relay	M0000 - M1535	M0000 - M1520		
Special Auxiliary Relay	M8000 - M8255	M8000 - M8240		 *2
State	S0000 - S0999	S0000 - S0992		
Timer (Contact)	TS000 - TS245	-----		*3
Counter (Contact)	CS000 - CS255	-----		*3
Timer (Current Value)	-----	TN000 - TN255		
Counter (Current Value)	-----	CN000 - CN199		
Counter (Current Value)	-----	CN200 - CN255		*4
Data Register	-----	 D0000 - D2999		 *5
Special Data Register	-----	D8000 - D8255		 *2

*1 Includes an area in which you cannot write.

*2 Special area. This area may be used by the system, and includes an area in which you cannot write. Please refer to the manual attached to the External Device for more detail.

*3 Write disable

*4 32-bit device.

*5 D1000-D2499 in FX0N is the file register.

To use this area in FX0N, you need set it as file register. Please refer to the manual attached to the External Device for more detail.

NOTE

- Please refer to the GP-Pro EX Reference Manual for system data area.

Cf. GP-Pro EX Reference Manual "Appendix 1.4 LS Area (only for direct access method)"







- Please refer to the precautions on manual notation for icons in the table.



"Manual Symbols and Terminology"

6.3 When using FX1S

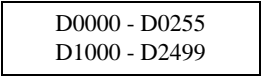
 This address can be specified as system data area.

Device	Bit Address	Word Address	32bits	Notes
Input Relay	X000 - X017	X000 - X000	L/H	 *1
Output Relay	Y000 - Y015	Y000 - Y000		
Internal Relay	M0000 - M0511	M0000 - M0496		
Special Auxiliary Relay	M8000 - M8255	M8000 - M8240		 *2
State	S0000 - S0127	S0000 - S0112		
Timer (Contact)	TS000 - TS063	-----		*3
Counter (Contact)	CS000 - CS031 CS235 - CS255	-----		*3
Timer (Current Value)	-----	TN000 - TN063		
Counter (Current Value)	-----	CN000 - CN031		
Counter (Current Value)	-----	CN235 - CN255		*4
Data Register	-----	 D0000 - D0255 D1000 - D2499		 *5
Special Data Register	-----	D8000 - D8255		 *2

*1 Includes an area in which you cannot write.

*2 Special area. This area may be used by the system, and includes an area in which you cannot write. Please refer to the manual attached to the External Device for more detail.

*3 Write disable

*4 32-bit device.

*5 D1000-D2499 in FX1S is the file register.







To use this area in FX1S, you need set it as file register. Please refer to the manual attached to the External Device for more detail.

NOTE

- Please refer to the GP-Pro EX Reference Manual for system data area.
Cf. GP-Pro EX Reference Manual "Appendix 1.4 LS Area (only for direct access method)"
- Please refer to the precautions on manual notation for icons in the table.
 "Manual Symbols and Terminology"

6.4 When using FX1N, FX1NC

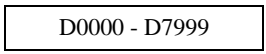
 This address can be specified as system data area.

Device	Bit Address	Word Address	32bits	Notes
Input Relay	X000 - X177	X000 - X160	[L/H]	 *1
Output Relay	Y000 - Y177	Y000 - Y160		
Internal Relay	M0000 - M1535	M0000 - M1520		
Special Auxiliary Relay	M8000 - M8255	M8000 - M8240		 *2
State	S000 - S999	S000 - S992		
Timer (Contact)	TS000 - TS255	-----		*3
Counter (Contact)	CS000 - CS255	-----		*3
Timer (Current Value)	-----	TN000 - TN255		
Counter (Current Value)	-----	CN000 - CN199		
Counter (Current Value)	-----	CN200 - CN255		*4
Data Register	-----	 D0000 - D7999		 *5
Special Data Register	-----	D8000 - D8255		 *2

*1 Includes an area in which you cannot write.

*2 Special area. This area may be used by the system, and includes an area in which you cannot write. Please refer to the manual attached to the External Device for more detail.

*3 Write disable

*4 32-bit device.

*5 You cannot use the data register D7999 as the 32-bit address device. This is because D8000 which is HIGH of the 32-bit device is handled as a different device.

NOTE

- Please refer to the GP-Pro EX Reference Manual for system data area.
Cf. GP-Pro EX Reference Manual "Appendix 1.4 LS Area (only for direct access method)"
- Please refer to the precautions on manual notation for icons in the table.

 "Manual Symbols and Terminology"

6.5 When using FX2N, FX2NC

 This address can be specified as system data area.

Device	Bit Address	Word Address	32bits	Notes
Input Relay	X000 - X377	X0000 - X0360	[L/H]	OCT 8 *1
Output Relay	Y000 - Y377	Y0000 - Y0360		OCT 8
Internal Relay	M0000 - M3071	M0000 - M3056		÷16
Special Auxiliary Relay	M8000 - M8255	M8000 - M8240		÷16 *2
State	S000 - S999	S000 - S992		÷16
Timer (Contact)	TS000 - TS255	-----		*3
Counter (Contact)	CS000 - CS255	-----		*3
Timer (Current Value)	-----	TN000 - TN255		
Counter (Current Value)	-----	CN000 - CN199		
Counter (Current Value)	-----	CN200 - CN255		*4
Data Register	-----	D0000 - D7999		Bit F *5
Special Data Register	-----	D8000 - D8255		Bit F *2

*1 Includes an area in which you cannot write.

*2 Special area. This area may be used by the system, and includes an area in which you cannot write. Please refer to the manual attached to the External Device for more detail.

*3 Write disable

*4 32-bit device.

*5 You cannot use the data register D7999 as the 32-bit address device. This is because D8000 which is HIGH of the 32-bit device is handled as a different device.











NOTE

- Please refer to the GP-Pro EX Reference Manual for system data area.
Cf. GP-Pro EX Reference Manual "Appendix 1.4 LS Area (only for direct access method)"
- Please refer to the precautions on manual notation for icons in the table.

 "Manual Symbols and Terminology"

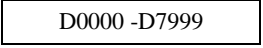
6.6 When using FX3U, FX3UC

 This address can be specified as system data area.

Device	Bit Address	Word Address	32bits	Notes
Input Relay	X000 - X377	X0000 - X0360		 *1
Output Relay	Y000 - Y377	Y0000 - Y0360		
Internal Relay	M0000 - M7679	M0000 - M7664		
Special Auxiliary Relay	M8000 - M8511	M8000 - M8496		 *2
State	S0000 - S4095	S0000 - S4080		
Timer (Contact)	TS000 - TS511	-----		*3
Counter (Contact)	CS000 -CS255	-----		*5
Timer (Current Value)	-----	TN000 - TN511		
Counter (Current Value)	-----	CN000 - CN199		
Counter (Current Value)	-----	CN200 - CN255		*4
Data Register	-----	 D0000 -D7999		 *5
Special Data Register	-----	D8000 - D8511		 *2
Extension Register	-----	R00000 - R32767		 *2

*1 Includes an area in which you cannot write.

*2 Special area. This area may be used by the system, and includes an area in which you cannot write. Please refer to the manual attached to the External Device for more detail.

*3 Write disable

*4 32-bit device.

*5 You cannot use the data register D7999 as the 32-bit address device. This is because D8000 which is HIGH of the 32-bit device is handled as a different device.

NOTE

- Please refer to the GP-Pro EX Reference Manual for system data area.
Cf. GP-Pro EX Reference Manual "Appendix 1.4 LS Area (only for direct access method)"
- Please refer to the precautions on manual notation for icons in the table.
 "Manual Symbols and Terminology"

7 Device Code and Address Code

Use device code and address code when you select "Device Type & Address" for the address type in data displays.

Device	Device Name	Device Code (HEX)	Address Code
Input Relay	X	0080	Value of word address divided by 0x10
Output Relay	Y	0081	Value of word address divided by 0x10
Internal Relay	M	0082	Value of word address divided by 16
Special Auxiliary Relay	M8	0083	Value of word address divided by 16
State	S	0087	Word Address
Timer (Current Value)	TN	0060	Word Address
Counter (Current Value)	CN	0061	Word Address
Counter (Current Value) *1	CN	0062	Word Address
Data Register	D	0000	Word Address
Special Data Register	D8	0001	Word Address
Extension Register *2	R	000F	Word Address

*1 32-bit device.

*2 Supported only by FX3U, FX3UC.

8 Error Messages

Error messages are displayed on the Display screen as follows: "No.: Device Name: Error Message (Error Occurrence Area)". Each description is shown below.

Item	Description
No.	Error No.
Device Name	Name of the External Device where error occurs. Device name is a title of the External Device set with GP-Pro EX. (Initial value [PLC1])
Error Message	Displays messages related to the error which occurs.
Error Occurrence Area	<p>Displays IP address or device address of the External Device where error occurs, or error codes received from the External Device.</p> <p>NOTE</p> <ul style="list-style-type: none"> • IP address is displayed such as "IP address(Decimal): MAC address(Hex)". • Device address is displayed such as "Address: Device address". • Received error codes are displayed such as "Decimal[Hex]".

Display Examples of Error Messages

"RHAA035: PLC1: Error has been responded for device write command (Error Code: 2 [02])"

-
- NOTE**
- Please refer to the manual of the External Device for more detail of received error codes.
 - Please refer to "When an error message is displayed (Error code list)" of "Maintenance/Troubleshooting" for a common error message to the driver.
-

