



MICREX-SX Series SIO Driver

1	System Configuration.....	3
2	Selection of External Device	6
3	Example of Communication Setting.....	7
4	Setup Items.....	10
5	Cable Diagram	14
6	Supported Device.....	19
7	Device Code and Address Code.....	35
8	Error Messages.....	36

Introduction

This manual describes how to connect the Display and the External Device (target PLC).

In this manual, the connection procedure will be described by following the below sections:

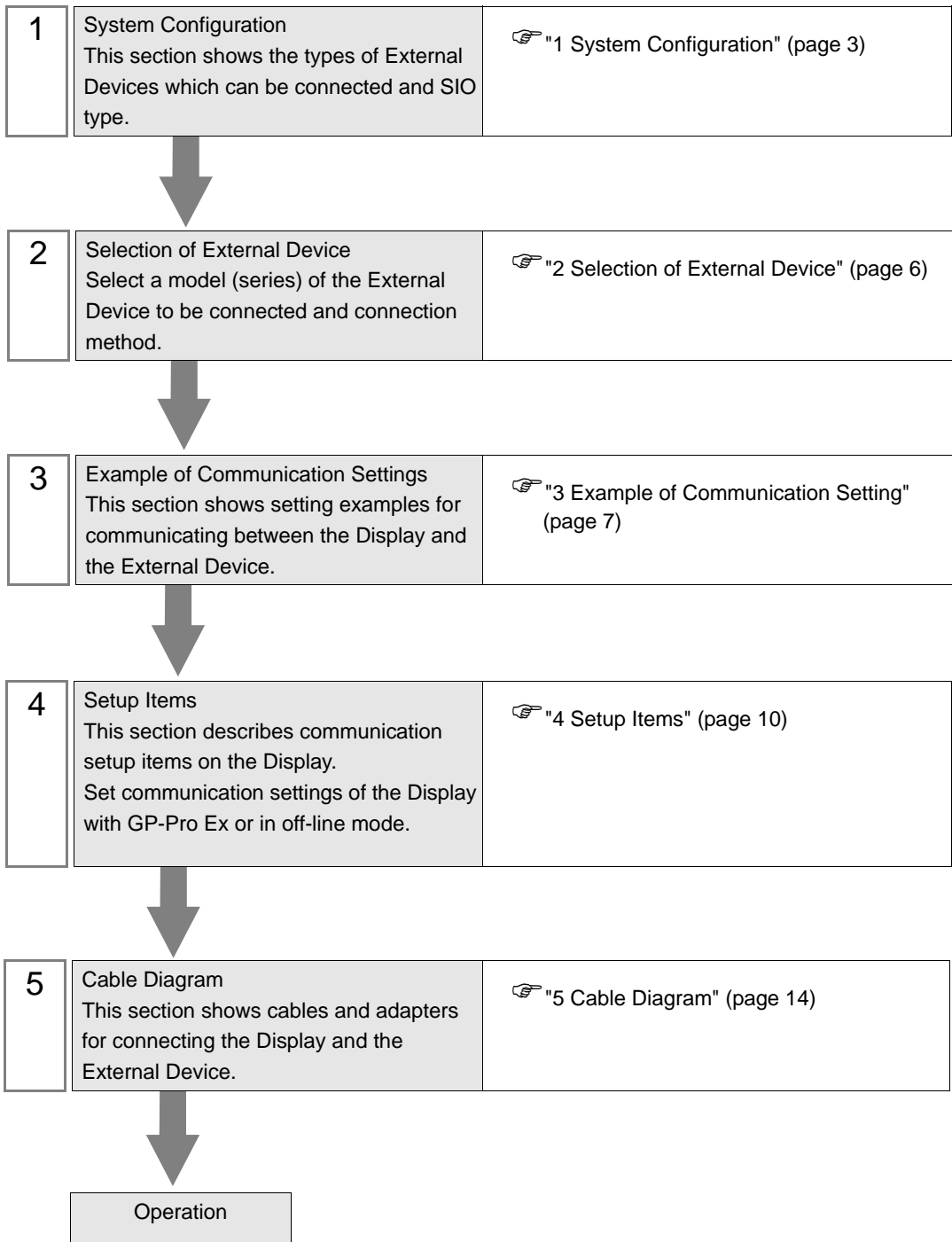

1 System Configuration

The system configuration in the case when the External Device of Fuji Electric Co., Ltd. and the Display are connected is shown.

Series	CPU	Link I/F	SIO Type	Setting Example	Cable Diagram
SPH	SPH200 (NP1PH-08 / NP1PH-16) SPH300 (NP1PS-32 / NP1PS-32R / NP1PS-74 / NP1PS-74R / NP1PS-117 / NP1PS-117R) SPH2000 (NP1PM-48E)	Loader Connection Connector on CPU unit	RS232C	"Setting Example 1" (page 7)	"Cable Diagram 1" (page 14)
		NP1L-RS1	RS232C	"Setting Example 2" (page 8)	"Cable Diagram 2" (page 15)
			RS422/485 (4wire)	"Setting Example 3" (page 9)	"Cable Diagram 3" (page 16)
		NP1L-RS2	RS232C	"Setting Example 2" (page 8)	"Cable Diagram 2" (page 15)
		NP1L-RS4	RS422/485 (4wire)	"Setting Example 3" (page 9)	"Cable Diagram 3" (page 16)

■ Connection Configuration

- 1:1 Connection

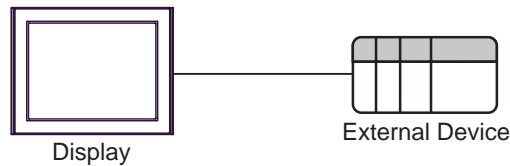

■ COM Port of IPC

When connecting IPC with External Device, the COM port which can be used changes with series and SIO type. Please refer to the manual of IPC for details.

Usable port

Series	Usable port		
	RS-232C	RS-422/485(4 wire)	RS-422/485(2 wire)
PS-2000B	COM1 ^{*1} , COM2, COM3 ^{*1} , COM4	-	-
PS-3450A, PS-3451A	COM1, COM2 ^{*1*2}	COM2 ^{*1*2}	COM2 ^{*1*2}
PS-3650A, PS-3651A	COM1 ^{*1}	-	-
PS-3700A (Pentium®4-M) PS-3710A	COM1 ^{*1} , COM2 ^{*1} , COM3 ^{*2} , COM4	COM3 ^{*2}	COM3 ^{*2}
PS-3711A	COM1 ^{*1} , COM2 ^{*2}	COM2 ^{*2}	COM2 ^{*2}
PL-3000B	COM1 ^{*1*2} , COM2 ^{*1} , COM3, COM4	COM1 ^{*1*2}	COM1 ^{*1*2}

*1 The RI/5V can be switched. Please switch with the change switch of IPC.

*2 It is necessary to set up the SIO type with the Dip switch. Please set up as follows according to SIO type to be used.

Dip switch setting: RS-232C

Dip switch	Setting	Description
1	OFF ^{*1}	Reserve (always OFF)
2	OFF	SIO type: RS-232C
3	OFF	
4	OFF	Output mode of SD (TXD) data: Always output
5	OFF	Terminal resistance (220Ω) insertion to SD (TXD): None
6	OFF	Terminal resistance (220Ω) insertion to RD (RXD): None
7	OFF	Short-circuit of SDA (TXA) and RDA (RXA): Does not Exist
8	OFF	Short-circuit of SDB (TXB) and RDB (RXB): Does not Exist
9	OFF	RS (RTS) Auto control mode: Disable
10	OFF	

*1 It is necessary to turn ON the set value, only when using PS-3450A and PS-3451A.

Dip switch setting: RS-422/485 (4 wire)

Dip switch	Setting	Description
1	OFF	Reserve (always OFF)
2	ON	SIO type: RS-422/485
3	ON	
4	OFF	Output mode of SD (TXD) data: Always output
5	OFF	Terminal resistance (220Ω) insertion to SD (TXD): None
6	OFF	Terminal resistance (220Ω) insertion to RD (RXD): None
7	OFF	Short-circuit of SDA (TXA) and RDA (RXA): Does not Exist
8	OFF	Short-circuit of SDB (TXB) and RDB (RXB): Does not Exist
9	OFF	RS (RTS) Auto control mode: Disable
10	OFF	

Dip switch setting: RS-422/485 (2 wire)

Dip switch	Setting	Description
1	OFF	Reserve (always OFF)
2	ON	SIO type: RS-422/485
3	ON	
4	OFF	Output mode of SD (TXD) data: Always output
5	OFF	Terminal resistance (220Ω) insertion to SD (TXD): None
6	OFF	Terminal resistance (220Ω) insertion to RD (RXD): None
7	ON	Short-circuit of SDA (TXA) and RDA (RXA): Exist
8	ON	Short-circuit of SDB (TXB) and RDB (RXB): Exist
9	ON	RS (RTS) Auto control mode: Enable
10	ON	

2 Selection of External Device

Select the External Device to be connected to the Display.

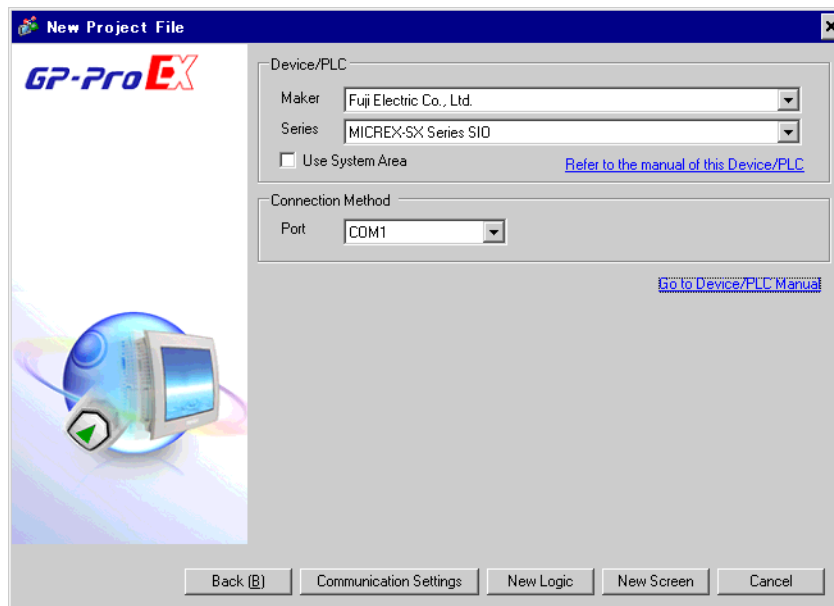

Setup Items	Setup Description
Maker	Select the maker of the External Device to be connected. Select "Fuji Electric Co., Ltd."
Series	Select a model (series) of the External Device to be connected and connection method. Select "MICREX-SX Series SIO". Check the External Device which can be connected in "MICREX-SX Series SIO" in system configuration. ☞ "1 System Configuration" (page 3)
Use System Area	Check this option when you synchronize the system data area of the Display and the device (memory) of the External Device. When synchronized, you can use the ladder program of the External Device to switch the display or display the window on the Display. Cf. GP-Pro EX Reference Manual "Appendix 1.4 LS Area (only for direct access method)" This can be also set with GP-Pro EX or in off-line mode of the Display. Cf. GP-Pro EX Reference Manual " 5.14.6 Setting Guide of [System Setting Window]■[Main Unit Settings] Settings Guide◆System Area Setting" Cf. Maintenance/Troubleshooting "2.14.1 Settings common to all Display models◆System Area Settings"

3 Example of Communication Setting

Examples of communication settings of the Display and the External Device, recommended by Pro-face, are shown.

3.1 Setting Example 1

■ Settings of GP-Pro EX

◆ Communication Settings

To display the setting screen, select [Device/PLC Settings] from [System setting window] in workspace.

Device/PLC 1

Summary [Change Device/PLC](#)

Maker Series Port

Text Data Mode [Change](#)

Communication Settings

SIO Type RS232C RS422/485(2wire) RS422/485(4wire)

Speed

Data Length 7 8

Parity NONE EVEN ODD

Stop Bit 1 2

Flow Control NONE ER(DTR/CTS) XON/XOFF

Timeout (sec)

Retry

Wait To Send (ms)

RI / VCC RI VCC

In the case of RS232C, you can select the 9th pin to RI (Input) or VCC (5V Power Supply). If you use the Digital's RS232C Isolation Unit, please select it to VCC.

Device-Specific Settings

Allowable Number of Devices/PLCs

Number	Device Name	Settings
<input type="button" value="1"/>	<input type="text" value="PLC1"/>	<input type="button" value="Settings"/>

◆ Device Setting

To display the setting screen, click  ([Setting]) of External Device you want to set from [Device-Specific Settings] of [Device/PLC Settings].

Individual Device Settings

PLC1

Use Variable Data

Variable Data

■ Settings of External Device

Communication setting of External Device is fixed, so setting is not necessary.

3.2 Setting Example 2

■ Settings of GP-Pro EX

◆ Communication Settings

To display the setting screen, select [Device/PLC Settings] from [System setting window] in workspace.

◆ Device Setting

To display the setting screen, click  ([Setting]) of External Device you want to set from [Device-Specific Settings] of [Device/PLC Settings].

■ Settings of External Device

Communication setting of External Device is fixed, so setting is not necessary.

Set the [Mode] switch of the link I/F unit to "1" (loader mode).

3.3 Setting Example 3

■ Settings of GP-Pro EX

◆ Communication Settings

To display the setting screen, select [Device/PLC Settings] from [System setting window] in workspace.

Device/PLC 1

Summary [Change Device/PLC](#)

Maker Series Port

Text Data Mode [Change](#)

Communication Settings

SIO Type RS232C RS422/485(2wire) RS422/485(4wire)

Speed

Data Length 7 8

Parity NONE EVEN ODD

Stop Bit 1 2

Flow Control NONE ER(DTR/CTS) XON/XOFF

Timeout (sec)

Retry

Wait To Send (ms)

RI / VCC RI VCC

In the case of RS232C, you can select the 9th pin to RI (Input) or VCC (5V Power Supply). If you use the Digital's RS232C Isolation Unit, please select it to VCC.

Device-Specific Settings

Number	Device Name	Settings
<input type="button" value="1"/>	<input type="text" value="PLC1"/>	<input type="button" value="Settings"/>

◆ Device Setting

To display the setting screen, click  ([Setting]) of External Device you want to set from [Device-Specific Settings] of [Device/PLC Settings].

Individual Device Settings

PLC1

Use Variable Data

Variable Data

■ Settings of External Device

Communication setting of External Device is fixed, so setting is not necessary.

Set the [Mode] switch of the link I/F unit to "2" (loader mode).

4 Setup Items

Set communication settings of the Display with GP-Pro EX or in off-line mode of the Display.

The setting of each parameter must be identical to that of External Device.

☞ "3 Example of Communication Setting" (page 7)

4.1 Setup Items in GP-Pro EX

■ Communication Settings

To display the setting screen, select [Device/PLC Settings] from [System setting window] in workspace.

Device/PLC 1

Summary [Change Device/PLC](#)

Maker Series Port

Text Data Mode [Change](#)

Communication Settings

SIO Type RS232C RS422/485(2wire) RS422/485(4wire)

Speed

Data Length 7 8

Parity NONE EVEN ODD

Stop Bit 1 2

Flow Control NONE ER(DTR/CTS) XON/XOFF

Timeout (sec)

Retry

Wait To Send (ms)

RI / VCC RI VCC

In the case of RS232C, you can select the 9th pin to RI (Input) or VCC (5V Power Supply). If you use the Digital's RS232C Isolation Unit, please select it to VCC.

Device-Specific Settings

Allowable Number of Devices/PLCs

Number Device Name

Setup Items	Setup Description
SIO Type	Select the SIO type to communicate with the External Device.
Speed	Select speed between the External Device and the Display.
Data Length	Select data length.
Parity	Select how to check parity.
Stop Bit	Select stop bit length.
Flow Control	Select the communication control method to prevent overflow of transmission and reception data.
Timeout	Use an integer from 1 to 127 to enter the time (s) for which the Display waits for the response from the External Device.
Retry	In case of no response from the External Device, use an integer from 0 to 255 to enter how many times the Display retransmits the command.
Wait To Send	Use an integer from 0 to 255 to enter standby time (ms) for the Display from receiving packets to transmitting next commands.
RI/VCC	You can switch RI/VCC of the 9th pin when you select RS232C for SIO type. It is necessary to change RI/5V by changeover switch of IPC when connect with IPC. Please refer to the manual of the IPC for more detail.

■ Device Setting

To display the setting screen, click  ([Setting]) of External Device you want to set from [Device-Specific Settings] of [Device/PLC Settings].

Set [Individual Device Settings] when using variable data.

 "6.4 When Using a Variable" (page 27)

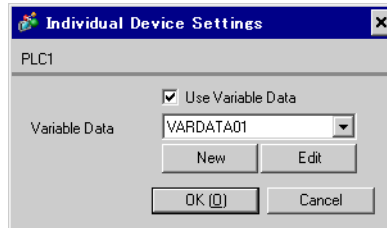

Setup Items	Setup Description
Use Variable Data	Put a check in the box when using variable data.
Variable Data	Select variable data.

4.2 Setup Items in Off-Line Mode

NOTE

- Please refer to Maintenance/Troubleshooting for more information on how to enter off-line mode or about operation.

Cf. Maintenance/Troubleshooting "2.2 Offline Mode"

■ Communication Settings

To display the setting screen, touch [Device/PLC Settings] from [Peripheral Settings] in off-line mode. Touch the External Device you want to set from the displayed list.

Comm.	Option			
MICREX-SX Series SIO		[COM1]	Page 1/1	
SIO Type	RS232C			
Speed	38400			
Data Length	<input type="radio"/> 7 <input checked="" type="radio"/> 8			
Parity	<input type="radio"/> NONE <input checked="" type="radio"/> EVEN <input type="radio"/> ODD			
Stop Bit	<input checked="" type="radio"/> 1 <input type="radio"/> 2			
Flow Control	ER(DTR/CTS)			
Timeout(s)	3			
Retry	2			
Wait To Send(ms)	0			
Exit		Back		2007/08/01 21:03:20

Setup Items	Setup Description
SIO Type	Select the SIO type to communicate with the External Device. IMPORTANT To make the communication settings correctly, confirm the serial interface specifications of Display unit for [SIO Type]. We cannot guarantee the operation if a communication type that the serial interface does not support is specified. For details concerning the serial interface specifications, refer to the manual for Display unit.
Speed	Select speed between the External Device and the Display.
Data Length	Select data length.
Parity	Select how to check parity.
Stop Bit	Select stop bit length.
Flow Control	Select the communication control method to prevent overflow of transmission and reception data.
Timeout	Use an integer from 1 to 127 to enter the time (s) for which the Display waits for the response from the External Device.

Continues to the next page.

Setup Items	Setup Description
Retry	In case of no response from the External Device, use an integer from 0 to 255 to enter how many times the Display retransmits the command.
Wait To Send	Use an integer from 0 to 255 to enter standby time (ms) for the Display from receiving packets to transmitting next commands.

■ Option

To display the setting screen, touch [Device/PLC Settings] from [Peripheral Equipment Settings]. Touch the External Device you want to set from the displayed list, and touch [Option].

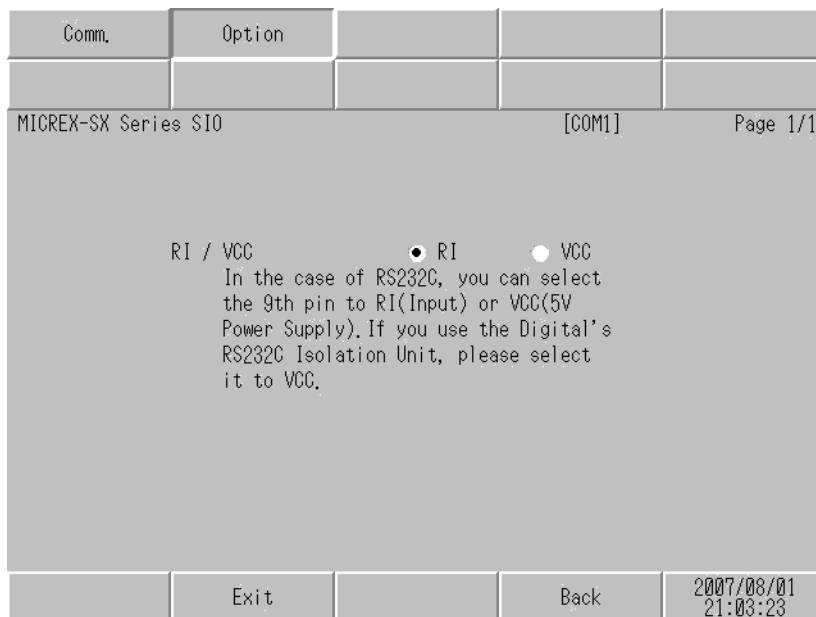

Setup Items	Setup Description
RI/VCC	Switches RI/VCC of the 9th pin. It is necessary to change RI/5V by changeover switch of IPC when connect with IPC. Please refer to the manual of the IPC for more detail.

5 Cable Diagram

The cable diagram shown below may be different from the cable diagram recommended by Fuji Electric Co., Ltd.. Please be assured there is no operational problem in applying the cable diagram shown in this manual.

- The FG pin of the External Device body must be D-class grounded. Please refer to the manual of the External Device for more details.
- SG and FG are connected inside the Display. When connecting SG to the External Device, design the system not to form short-circuit loop.
- Connect the isolation unit, when communication is not stabilized under the influence of a noise etc.

Cable Diagram 1

Display (Connection Port)	Cable	Notes
GP (COM1) IPC*1 PC/AT	Connection adapter by Fuji Electric Co., Ltd. NW0H-CNV + Connection cable by Fuji Electric Co., Ltd. NP4HCB2 (2m)	

*1 Only the COM port which can communicate by RS-232C can be used.
☞ "■ COM Port of IPC" (page 4)

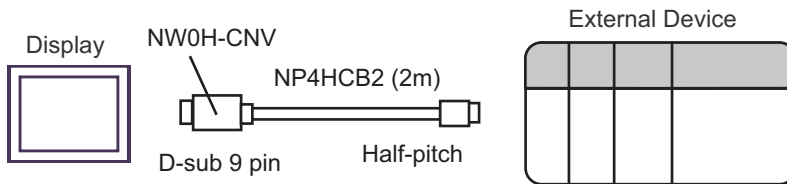

Cable Diagram 2

Display (Connection Port)	Cable	Notes
GP (COM1) IPC*1 PC/AT	Your own cable	The cable length must be 15m or less.

*1 Only the COM port which can communicate by RS-232C can be used.
 "■ COM Port of IPC" (page 4)

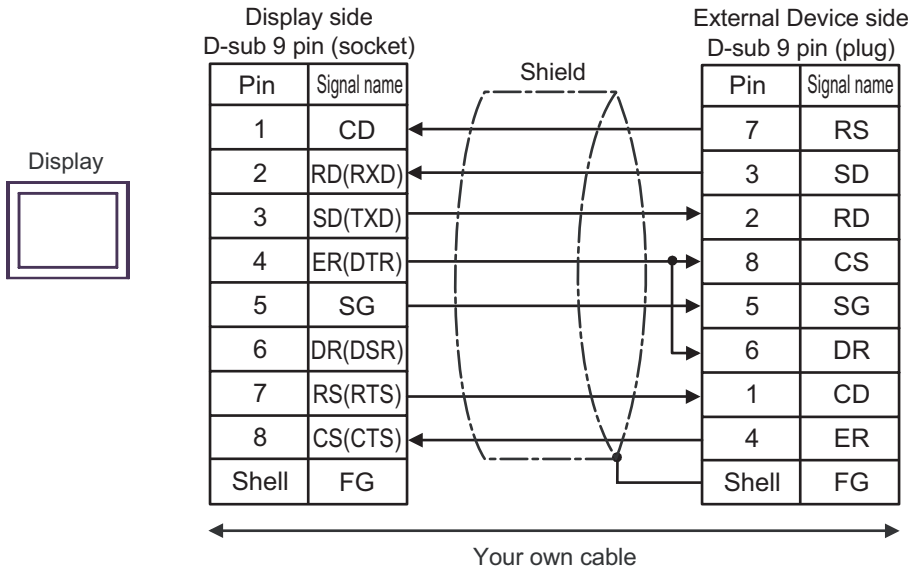

Cable Diagram 3

Display (Connection Port)	Cable		Notes
GP* ¹ (COM1) AGP-3302B (COM2) IPC* ²	A	COM port conversion adapter by Pro-face CA3-ADPCOM-01 + Terminal block conversion adapter by Pro-face CA3-ADPTRM-01 + Your own cable	The cable length must be 1000m or less.
	B	Your own cable	
GP* ³ (COM2)	C	Online adapter by Pro-face CA4-ADPONL-01 + Terminal block conversion adapter by Pro-face CA3-ADPTRM-01 + Your own cable	Termination resistance switch on the communication module should be set "3".
	D	Online adapter by Pro-face CA4-ADPONL-01 + Your own cable	

*1 All GP models except AGP-3302B

*2 Only the COM port which can communicate by RS-422/485 (4 wire) can be used.
 "■ COM Port of IPC" (page 4)

*3 All GP models except GP-3200 series and AGP-3302B

A) When using the COM port conversion adapter (CA3-ADPCOM-01), the terminal block conversion adapter (CA3-ADPTRM-01) by Pro-face and your own cable

- 1:1 Connection

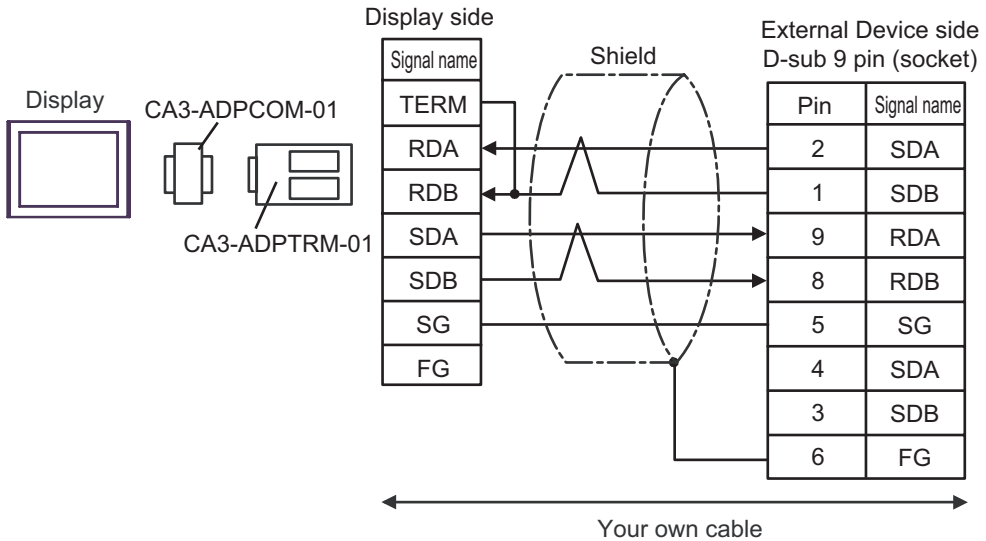

* Termination resistance switch on the communication module should be set "3".

B) When using your own cable

- 1:1 Connection

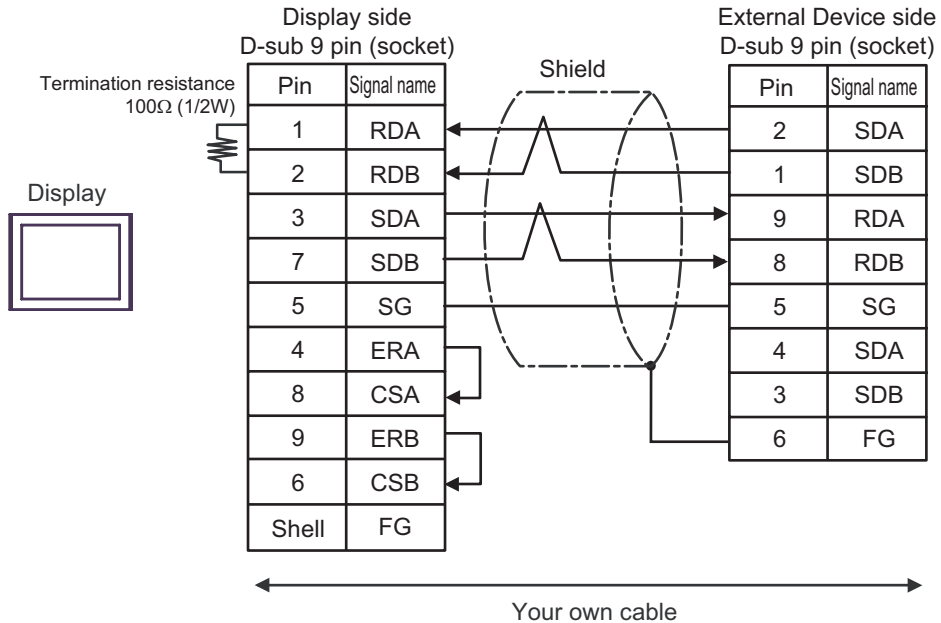

* Termination resistance switch on the communication module should be set "3".

C) When using the online adapter (CA4-ADPONL-01) by Pro-face, the terminal block conversion adapter (CA3-ADPTRM-01) by Pro-face and your own cable

- 1:1 Connection

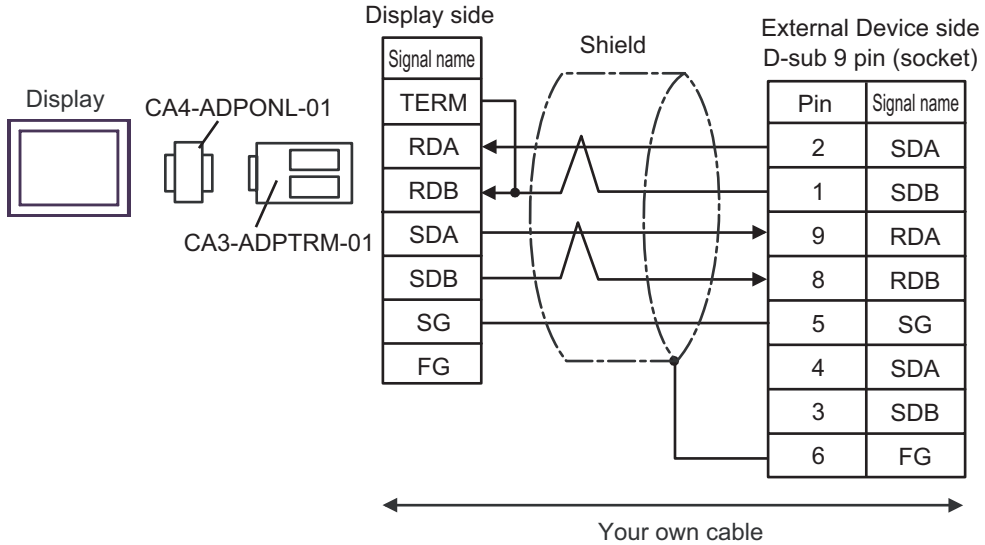

* Termination resistance switch on the communication module should be set "3".

D) When using the online adapter (CA4-ADPONL-01) by Pro-face and your own cable

- 1:1 Connection

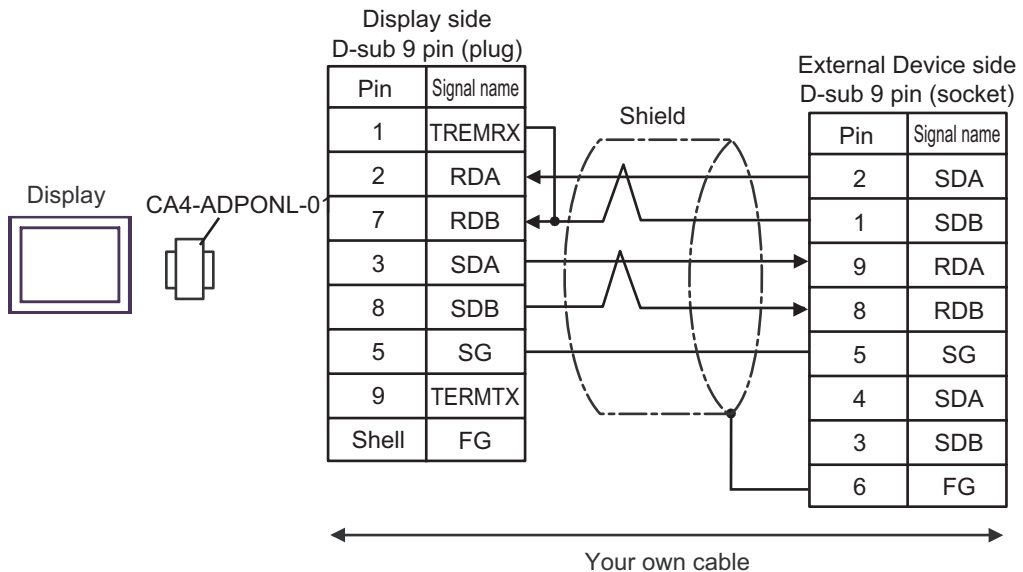

* Termination resistance switch on the communication module should be set "3".

6 Supported Device

Range of supported device address is shown in the table below. Please note that the actually supported range of the devices varies depending on the External Device to be used. Please check the actual range in the manual of your External Device.

Enter the External Device address in the dialog below.

■ When [Addressing Mode] is "Direct"

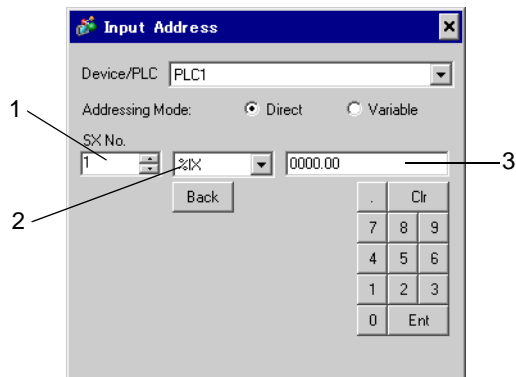

- 1 Enter [SX No.] (Input/Output Memory) or [CPU NO.] (Standard/Retain/System Memory).
- 2 Select a device.
- 3 Enter the address.

■ When [Addressing Mode] is "Variable"

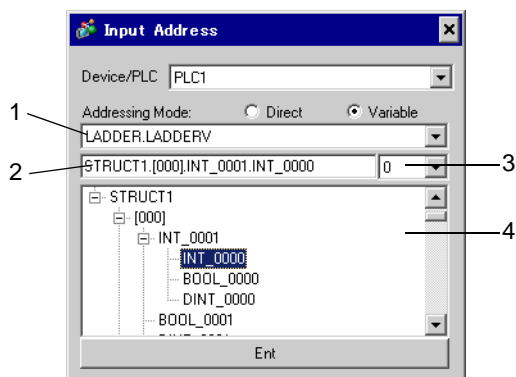

- 1 Select a worksheet.
- 2 Enter the address.
- 3 When inputting a bit address, select the bit position of bit address.
- 4 Variable data is displayed. The address can be entered by double-clicking the displayed variable.

☞ " ■ Making New Variable Data" (page 31)

■ Ladder Software

There are SX-Programmer Expert (D300win) and SX-Programmer Standard in the ladder software to be used for setting the External Device. The device name differs respectively as follows.

Device Name		SX-Programmer Expert (D300win)	SX-Programmer Standard
I/O Memory	Input	%I	X
	Output	%Q	Y
Standard Memory (fast)		%MW1.0 - %MW1.2047	WM0 - WM2047
Standard Memory ^{*1}		%MW1.2048 - %MW1.262143	WM2048 - WM262143
Retain Memory ^{*1}		%MW3.0 - %MW3.260095	WL0 - WL260095
System Memory		%MW10.0 - %MW10.511	WSM0 - WSM511

*1 The number of device items can be increased or decreased by the ladder tool. This table shows the number of default items.

6.1 SPH200

▬▬▬ This address can be specified as system data area.

Device	Bit Address	Word Address	32bits	Remarks
Input Memory	%IX□.0000.00 - %IX□.0511.15	%IW□.0000 - %IW□.0511	[L / H]	*1
Output Memory	%QX□.0000.00 - %QX□.0511.15	%QW□.0000 - %QW□.0511		*1
Standard Memory	%MX□.1.0000000.00 - %MX□.1.0008191.15	%MW□.1.0000000 - %MW□.1.0008191		*2 *3
Retain Memory	%MX□.3.000000.00 - %MX□.3.004095.15	%MW□.3.000000 - %MW□.3.004095		*2 *3
System Memory	%MX□.10.000000.00 - %MX□.10.008191.15	%MW□.10.000000 - %MW□.10.008191		*2

*1 Input/Output Memory Address Designation is as shown below.

• Bit Designation

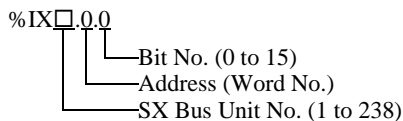

• Word Designation

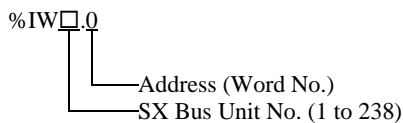

NOTE

- Please refer to the SX Bus Unit No. details in the manual of External Device.

*2 Standard/Retain/System Memory Address Designation is as shown below.

• Bit Designation

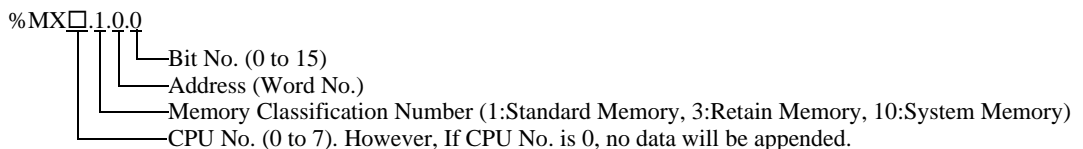

• Word Designation

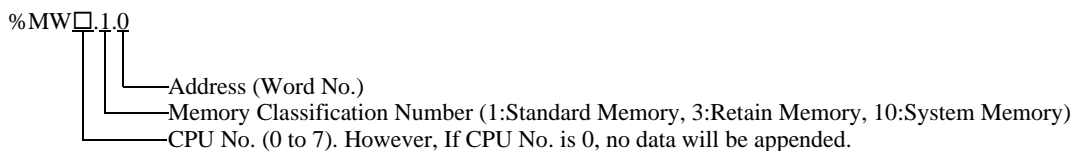

*3 Standard and Retain Memory sizes can be changed. However, the total memory size is fixed. (For details, refer to the manual of External Device).

NOTE

- When specifying the address of the External Device directly, always use a setting within the specified AT range of the ladder software. We recommend using an AT-specified- variable for the External Device used on the Display. Please refer to the Micrex-SX Series D300Win <Reference> Users Manual by Fuji Electric Co., Ltd. for details of specifying the AT range and how to set it. When using a variable that is not AT-specified, variable needs to be imported again and screen transfer needs to be executed if ladder program or variable is changed.
- Always use a system area and reading area within the specified AT range.
- Use high performance CPU system area with an address of %MW1.2048 or later.
- Please refer to the GP-Pro EX Reference Manual for system data area.
Cf. GP-Pro EX Reference Manual "Appendix 1.4 LS Area (only for direct access method)"
- Please refer to the precautions on manual notation for icons in the table.
 "Manual Symbols and Terminology"

6.2 SPH300

▬▬▬ This address can be specified as system data area.

Device	Bit Address	Word Address	32bits	Remarks
Input Memory	%IX□.0000.00 - %IX□.0511.15	%IW□.0000 - %IW□.0511	[L / H]	*1
Output Memory	%QX□.0000.00 - %QX□.0511.15	%QW□.0000 - %QW□.0511		*1
Standard Memory	%MX□.1.0000000.00 - %MX□.1.0262143.15	%MW□.1.0000000 - %MW□.1.0262143		*2 *3
Retain Memory	%MX□.3.000000.00 - %MX□.3.130047.15	%MW□.3.000000 - %MW□.3.130047		*2 *3
System Memory	%MX□.10.000000.00 - %MX□.10.065535.15	%MW□.10.000000 - %MW□.10.065535		*2

*1 Input/Output memory Address Designation is as shown below.

• Bit Designation

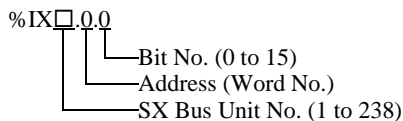

• Word Designation

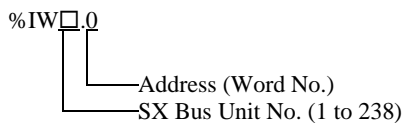

NOTE

Please refer to the SX Bus Unit No. details in the manual of External Device.

*2 Standard/Retain/System Memory Address Designation is as shown below.

• Bit Designation

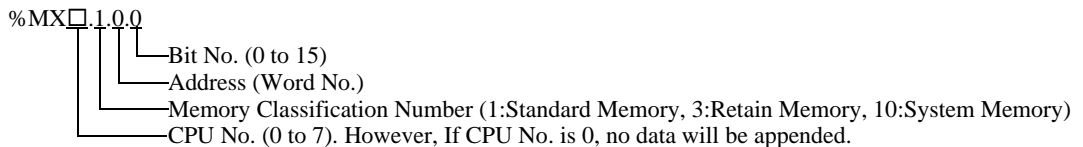

• Word Designation

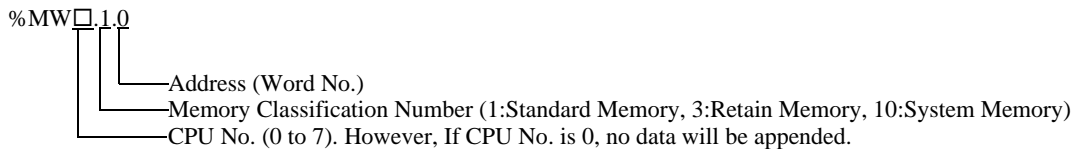

*3 Standard and Retain Memory sizes can be changed. However, the total memory size is fixed. (For details, refer to the manual of External Device).

NOTE

- When specifying the address of the External Device directly, always use a setting within the specified AT range of the ladder software. We recommend using an AT-specified- variable for the External Device used on the Display. Please refer to the Micrex-SX Series D300Win <Reference> Users Manual by Fuji Electric Co., Ltd. for details of specifying the AT range and how to set it. When using a variable that is not AT-specified, variable needs to be imported again and screen transfer needs to be executed if ladder program or variable is changed.
- Always use a system area and reading area within the specified AT range.
- Use high performance CPU system area with an address of %MW1.2048 or later.
- Please refer to the GP-Pro EX Reference Manual for system data area.
Cf. GP-Pro EX Reference Manual "Appendix 1.4 LS Area (only for direct access method)"
- Please refer to the precautions on manual notation for icons in the table.
 "Manual Symbols and Terminology"

6.3 SPH2000

 This address can be specified as system data area.

Device	Bit Address	Word Address	32bits	Remarks
Input Memory	%IX□.0000.00 - %IX□.0511.15	%IW□.0000 - %IW□.0511	[L / H]	*1
Output Memory	%QX□.0000.00 - %QX□.0511.15	%QW□.0000 - %QW□.0511		*1
Standard Memory	%MX□.1.0000000.00 - %MX□.1.1703935.15	%MW□.1.0000000 - %MW□.1.1703935		*2 *3
Retain Memory	%MX□.3.000000.00 - %MX□.3.262143.15	%MW□.3.000000 - %MW□.3.262143		*2 *3
System Memory	%MX□.10.000000.00 - %MX□.10.065535.15	%MW□.10.000000 - %MW□.10.065535		*2

*1 Input/Output memory Address Designation is as shown below.

• Bit Designation

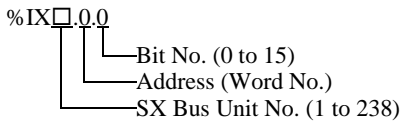

• Word Designation

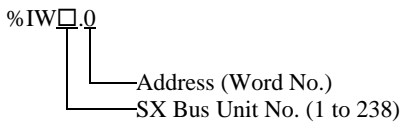

NOTE

Please refer to the SX Bus Unit No. details in the manual of External Device.

*2 Standard/Retain/System Memory Address Designation is as shown below.

• Bit Designation

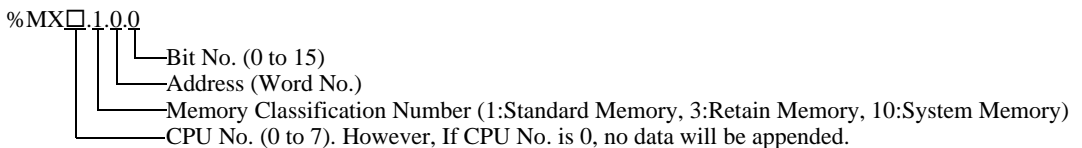

• Word Designation

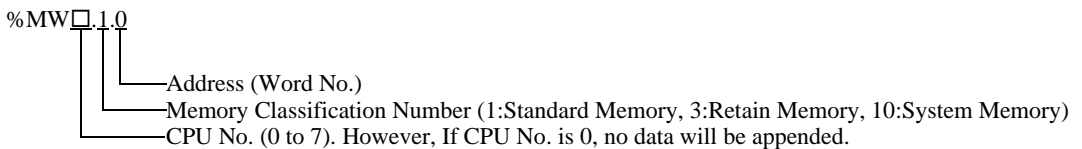

*3 Standard and Retain Memory sizes can be changed. However, the total memory size is fixed. (For details, refer to the manual of External Device).

NOTE

- When specifying the address of the External Device directly, always use a setting within the specified AT range of the ladder software. We recommend using an AT-specified- variable for the External Device used on the Display. Please refer to the Micrex-SX Series D300Win <Reference> Users Manual by Fuji Electric Co., Ltd. for details of specifying the AT range and how to set it. When using a variable that is not AT-specified, variable needs to be imported again and screen transfer needs to be executed if ladder program or variable is changed.
- Always use a system area and reading area within the specified AT range.
- Use high performance CPU system area with an address of %MW1.2048 or later.
- Please refer to the GP-Pro EX Reference Manual for system data area.
Cf. GP-Pro EX Reference Manual "Appendix 1.4 LS Area (only for direct access method)"
- Please refer to the precautions on manual notation for icons in the table.
 "Manual Symbols and Terminology"

6.4 When Using a Variable

■ Usable Device

The table below shows the Base Data Types of usable Variables.

Data Type		Bit Address	Word Address	32bits	Remarks
BOOL	Single Var	<VARNAME>	-	-	*1 *2 *3
	1D Array	<VARNAME>.[0] to <VARNAME>.[x-1]	-	-	
INT UINT WORD	Single Tag	< VARNAME >.00 to < VARNAME >.15	< VARNAME >	L/H	*1 *2
	1D Array	< VARNAME >.[0].00 to < VARNAME >.[x-1].15	< VARNAME >.[0] to < VARNAME >.[x-1]		
	2D Array	< VARNAME >.[0].[0].00 to < VARNAME >.[x-1].[y-1].15	< VARNAME >.[0].[0] to < VARNAME >.[x-1].[y-1]		
	3D Array	< VARNAME >.[0].[0].[0].00 to < VARNAME >.[x-1].[y-1].[z-1].15	<VARNAME>.[0].[0].[0] to <VARNAME>.[x-1].[y-1].[z-1]		
DINT UDINT DWORD REAL TIME	Single Tag	< VARNAME >.00 to < VARNAME >.31	< VARNAME >	-	*1 *2
	1D Array	< VARNAME >.[0].00 to < VARNAME >.[x-1].31	< VARNAME >.[0] to < VARNAME >.[x-1]		
	2D Array	< VARNAME >.[0].[0].00 to < VARNAME >.[x-1].[y-1].31	< VARNAME >.[0].[0] to < VARNAME >.[x-1].[y-1]		
	3D Array	< VARNAME >.[0].[0].[0].00 to < VARNAME >.[x-1].[y-1].[z-1].31	< VARNAME >.[0].[0].[0] to < VARNAME >.[x-1].[y-1].[z-1]		
STRING	Single Tag	-	<VARNAME>	-	*1 *4

*1 <VARNAME>: This is the complete "Variable" name including "Worksheet" name and "Structure" name if it is a sub element of a structure. Maximum 255 characters including delimiters ('.') and address part (e.g. bit position and array information).

e.g. BOOL type single tag in a Global Worksheet:

"CONF.MainResource.Global_Variables.BOOLVAR"

e.g. INT type single tag in a Local Worksheet:

"MainProgram.MainProgramV.INTVAR"

e.g. DINT type bit address: "MainProgram.MainProgramV.DINTVAR.30"

e.g. REAL type 3D array: "MainProgram.MainProgramV.REALARRAY[1].[2].[3]"

e.g. DINT from a TIMER structure: "MainProgram.MainProgramV.TIMERVAR.PRE"

e.g. BOOL from a User Defined Structure :

"CONF.MainResource.Global_Variables.USERSTRUCTURE_
A.USERSTRUCTRE_B.MYTIMER.EN"

*2 Array Dimensions: If a "Variable" is an array it has a defined size. It is possible to create multidimensional arrays. In the above example up to 3D arrays are shown, but more is also possible.

*3 BOOL type arrays: The External Device address must start on bit 0. e.g. %MX1.100.0

*4 STRING type: Array access is not possible. Also the "STRING" cannot be used as part of a structure. More information about "STRING" type is below.

NOTE

- When specifying the address of the Eternal Device directly, always use a setting within the specified AT range of the ladder software. We recommend using an AT-specified- variable for the External Device used on the Display. Please refer to the Micrex-SX Series D300Win <Reference> Users Manual by Fuji Electric Co., Ltd. for details of specifying the AT range and how to set it. When using a variable that is not AT-specified, variable needs to be imported again and screen transfer needs to be executed if ladder program or variable is changed.
- Always use a system area and reading area within the specified AT range.
- Use high performance CPU system area with an address of %MW1.2048 or later.
- Please refer to the GP-Pro EX Reference Manual for system data area.
Cf. GP-Pro EX Reference Manual "Appendix 1.4 LS Area (only for direct access method)"
- Please refer to the precautions on manual notation for icons in the table.
☞ "Manual Symbols and Terminology"

To use a variable and Derived Data Type that were set by D300win with the GP-Pro EX, CSV file and IEC file need to be imported.

CSV file and IEC file are exported by D300win.

Imported data is saved as variable data.

■ Setting Items of [Variable] List Dialog Box

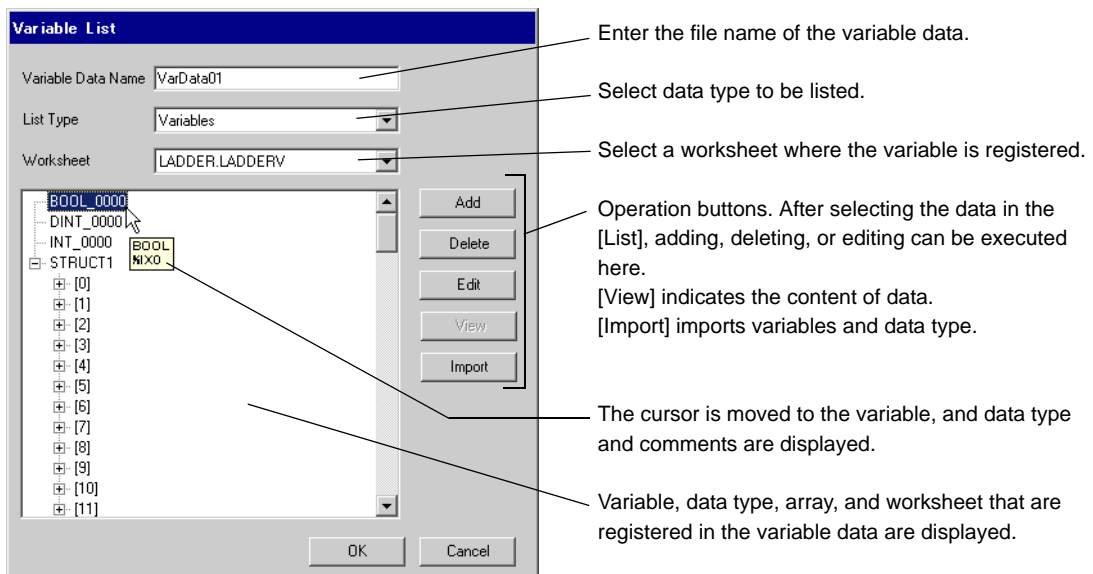

■ Importing Variable and Data Type

- 1 Set variable, data type, array, and worksheet with D300win.

Version of D300win that is supported is V3.1.0.0 or later.

- 2 Select [Export] from the [File] menu and select the data to be exported.

Data below needs to be exported.

Data to be exported	Description	File type
Cross reference	Variable and worksheet	CSV
IEC 61131-3	Data type and array	IEC

- 3 Make [Individual Device Settings] dialog box displayed with the GP-ProEX, and put a check to [Use Variable Data]. Then click [New].

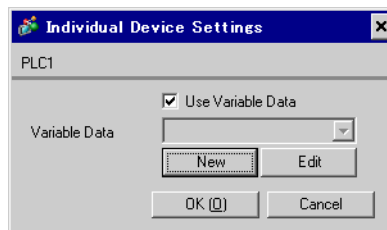

- 4 Enter the name of variable data to save the setting in the [Variable Data Name].

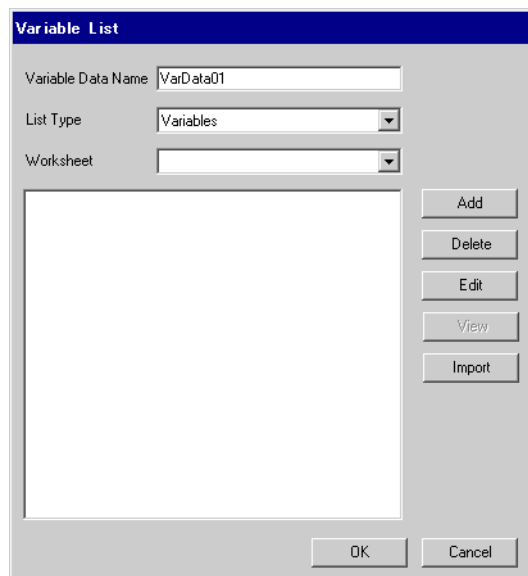

5 Click [Import] to import CSV file and IEC file that were exported in the Procedure 2.

Import IEC file first followed by CSV file.

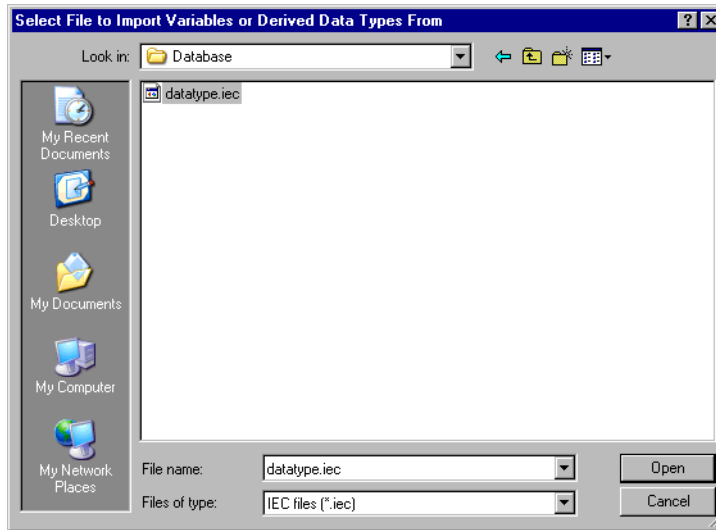

NOTE

- When CSV file including variable with the user-defined data type is imported prior to IEC file, an error, "Unknown Data Type was found" is displayed and variable is not imported. Import IEC file first in order to register the user-defined data type.

6 Confirm the registered data and click [OK].

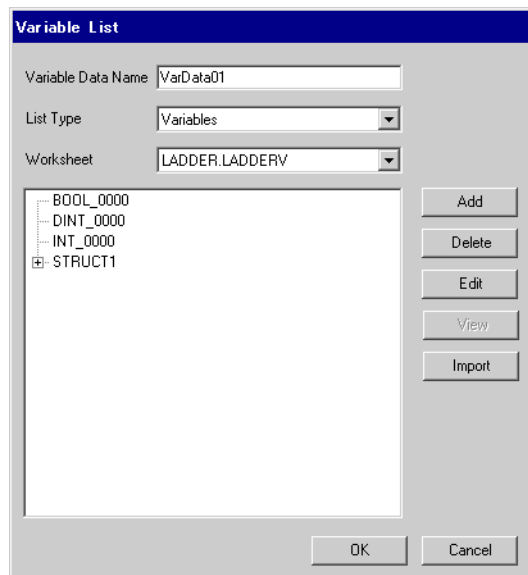

■ Making New Variable Data

If variable data is not imported, make variable data using the following procedures.

◆ Making Variable

- 1 Select "Variables" from the [List Type] of the [Variable List] dialog box.

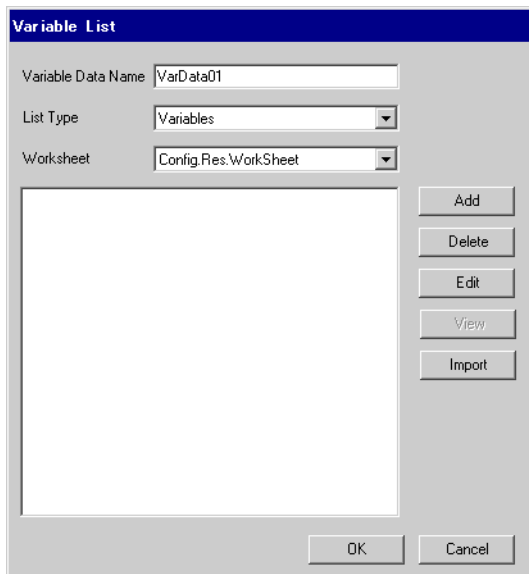

- 2 Click [Add] to display [Variable] dialog box.

NOTE

- To add a variable, the worksheet needs to be set. Make the worksheet before making the variable.

☞ "◆ Making a Worksheet" (page 34)

- 3 Enter "Name", "Data Type", "Address" and "Comment" and click [OK].

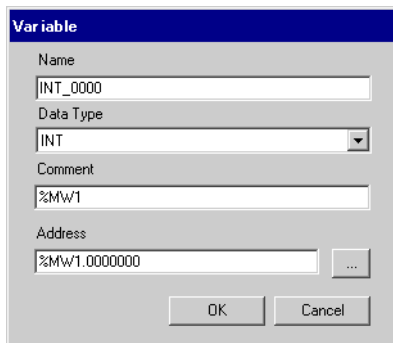

◆ Making Derived Data Type

1 Select "Structures" from the [List Type] of the [Variable List] dialog box.

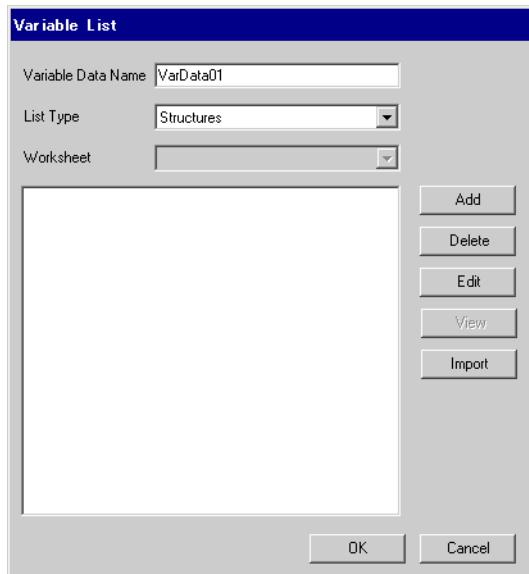

2 Click [Add] to display [Derived Data Type (Structure)] dialog box.

3 Enter the "Name" of the member and "Data Type" to be included in "Derived Data Type Name" and data type and click [OK].

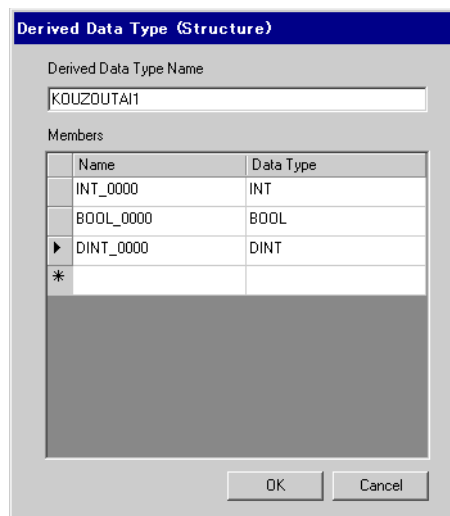

◆ Making an Array

1 Select "Arrays" from the [List Type] of the [Variable List] dialog box.

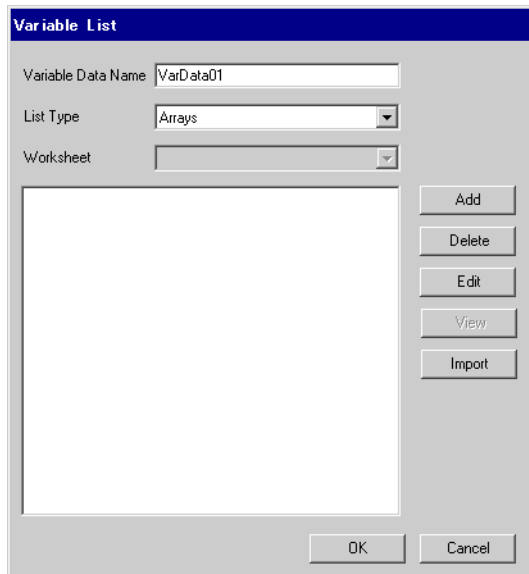

2 Click [Add] to display [Derived Data Type (Array)] dialog box.

3 Enter "Array Name", "Data Type", "Start Element" and "End Element" and click [OK].

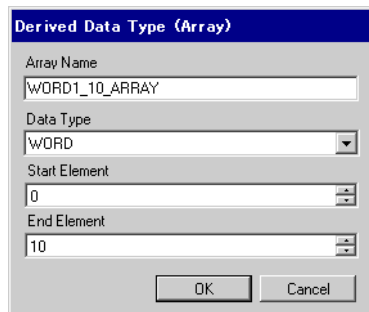

◆ Making a Worksheet

- 1 Select "Worksheets" from the [List Type] of the [Variable List] dialog box.

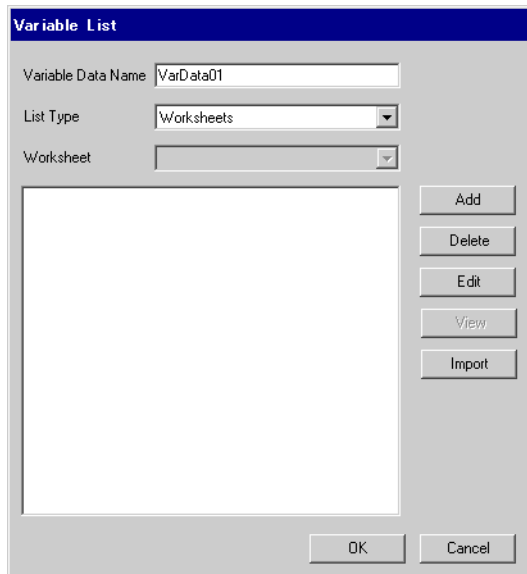

- 2 Click [Add] to display [Worksheet] dialog box.
- 3 Enter "Configuration", "Resource/Program" and "Worksheet" and click [OK].

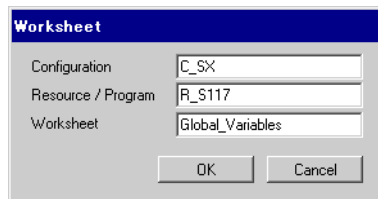

7 Device Code and Address Code

Use device code and address code when you select "Device Type & Address" for the address type in data displays.

NOTE

- When using a variable, device code and address code cannot be used.

Device	Device Name	Device Code (HEX)	Address Code
Input Memory	%IX/%IW	0083	SX Bus Unit No. × 0x1000000 + Word Address
Output Memory	%QX/%QW	0084	SX Bus Unit No. × 0x1000000 + Word Address
Standard Memory	%MX1./%MW1.	0080	CPU No. × 0x1000000 + Word Address
Retain Memory	%MX3./%MW3.	0081	CPU No. × 0x1000000 + Word Address
System Memory	%MX10./%MW10.	0082	CPU No. × 0x1000000 + Word Address

8 Error Messages

Error messages are displayed on the screen of Display as follows: "No. : Device Name: Error Message (Error Occurrence Area)". Each description is shown below.

Item	Description
No.	Error No.
Device Name	Name of External Device where error occurs. Device name is a title of External Device set with GP-Pro EX. (Initial value [PLC1])
Error Message	Displays messages related to the error which occurs.
Error Occurrence Area	<p>Displays IP address or device address of External Device where error occurs, or error codes received from External Device.</p> <p>NOTE</p> <ul style="list-style-type: none"> • IP address is displayed such as "IP address (Decimal): MAC address (Hex)". • Device address is displayed such as "Address: Device address". • Received error codes are displayed such as "Decimal [Hex]".

Display Examples of Error Messages

"RHAA035: PLC1: Error has been responded for device write command (Error Code: 2 [02])"

NOTE

- Please refer to the manual of External Device for more detail of received error codes.
- Please refer to "When an error message is displayed (Error code list)" of "Maintenance/Troubleshooting" for a common error message to the driver.

■ Error Code Unique for Driver

Error Code	Description	Comment
0x10	CPU Error	An error occurs in the CPU and a command cannot be executed.
0x12	Command cannot be executed.	Due to CPU's key switch condition, a command cannot be executed.
0x23	During transmission interlocking	Transmission is interlocked due to a loader command from another device.
0x28	During command processing	Requested command cannot be executed because other command is in process.
0x2B	During other loader processing	Request command cannot be executed because D300win loader is in process.
0x2F	Initialization incomplete	Requested command cannot be executed because system is initializing.
0x44	Memory addressing error	Specified address exceeds effective area.
0x45	Memory size over	Address + reading/the number of written words exceeds the effective area.

■ Error Message Unique for Driver

Error Code	Error Message	Description
RHxx128	"(Node Name):The number of specified destination module is not existed.(Error Code: [Hex])"	Command destination specification error. Check module is present / online and that the configuration is correct.