

# 13 | Using Lamps

This chapter explains how to display and operate the "Lamp" in GP-Pro EX. Please start by reading "13.1 Settings Menu" (page 13-2) and then turn to the corresponding page.

13.1	Settings Menu .....	13-2
13.2	Turning the Lamp ON/OFF with the ON/OFF Bit .....	13-4
13.3	Switching by Turning Multiple Bits ON/OFF (Up to 5 States) .....	13-8
13.4	Switching by a Combination of Multiple Bits (Up to 16 States) .....	13-13
13.5	Switching by the Word Address Bit Change (Bit Settings) .....	13-18
13.6	Switching by Word Address Data Change (Up to 16 States) .....	13-23
13.7	Procedure for Creating a Lamp.....	13-28
13.8	Lamp Settings Guide.....	13-30

## 13.1 Settings Menu

**Turning the Lamp ON/OFF with the ON/OFF Bit**

Turned ON with the specified bit address ON

X100: ON → Turned ON



Turned OFF with the specified bit address OFF

X100: OFF → Turned OFF

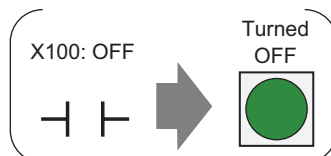

☞ Setup Procedure (page 13-5)

☞ Introduction (page 13-4)

---

**Switching by Turning Multiple Bits ON/OFF (Up to 5 States)**

On the GP, one lamp can display an ON/OFF state with different colors for each of four bit operations of a device/PLC.

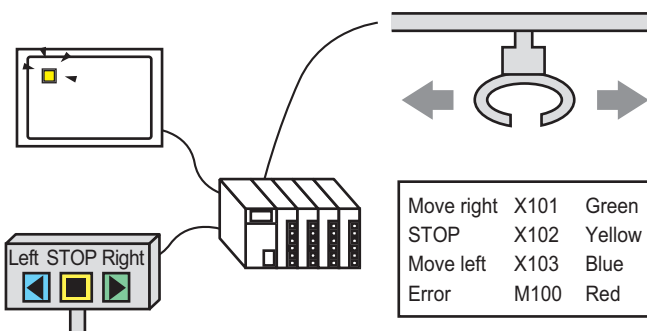

Move right	X101	Green
STOP	X102	Yellow
Move left	X103	Blue
Error	M100	Red

☞ Setup Procedure (page 13-9)

☞ Introduction (page 13-8)

---

**Switching by a Combination of Multiple Bits (Up to 16 States)**

On the GP, one lamp can display an ON/OFF state with different colors for each of four bit address combinations of a device/PLC.

Display with different colors depending on bit combinations

State	Display Color	X104	X103	X102	X101
State 00	Blue	0	0	0	0
State 01	Red	0	0	0	1
State 02	Yellow	0	0	1	0
State 03	Green	0	0	1	1
⋮	⋮	⋮	⋮	⋮	⋮

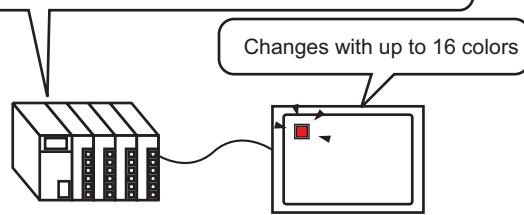

☞ Setup Procedure (page 13-14)

☞ Introduction (page 13-13)

GP-Pro EX Reference Manual

13-2

**Switching by the Word Address Bit Change (Bit Settings)**

On the GP, one lamp can display with different colors each of the 16 bits of a Word Address on a device/PLC.

- ☞ Setup Procedure (page 13-19)
- ☞ Introduction (page 13-18)

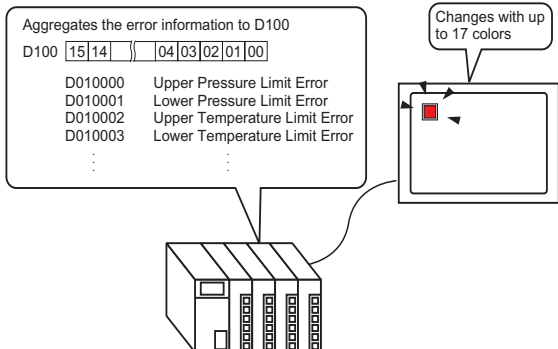

**Switching by Word Address Data Change (Up to 16 States)**

Seeing the data "0 to 15" stored in the Word address, one lamp displays the state with different colors.

- ☞ Setup Procedure (page 13-24)
- ☞ Introduction (page 13-23)

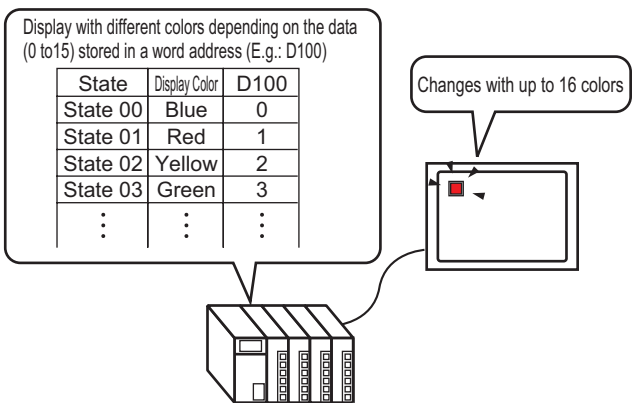

## 13.2 Turning the Lamp ON/OFF with the ON/OFF Bit

### 13.2.1 Introduction

Displays the device/PLC bit operation X100 ON/OFF state on the GP.

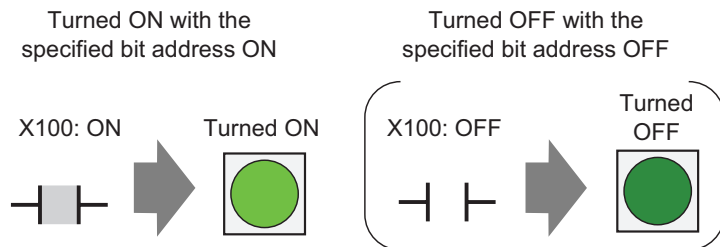

---

**IMPORTANT**

- If the state display is set to [Interlock Feature] or [Delay Feature], then [Interlock Condition Display] has the highest priority followed by [In-Delay Status Display]. Consequently, the lamp may not be displayed as expected. You can access this option from the [Switch/Lamp] dialog box, select the [Switch Common] tab and then select [Detail].
-

### 13.2.2 Setup Procedure

**NOTE**

- Please refer to the settings guide for details.
  - ☞ “13.8 Lamp Settings Guide” (page 13-30)
- For details of the part placement method and the address, shape, color, and label setting method, refer to the "Part Editing Procedure".
  - ☞ “9.6.1 Editing Parts” (page 9-38)

Displays the device/PLC bit operation X100 ON/OFF state on the GP.

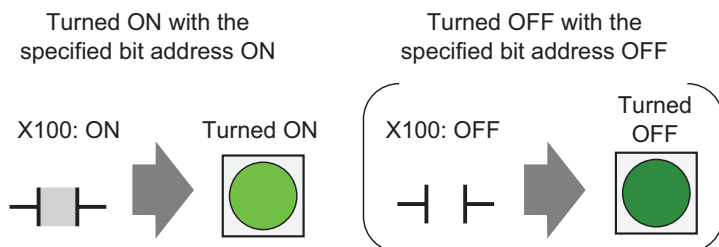

- 1 From the [Parts (P)] menu, point to [Switch Lamp (C)] and select [Lamp (L)] or click from the toolbar. Place the Part on the screen.
- 2 Double-click the placed lamp. The Switch/Lamp dialog box appears.

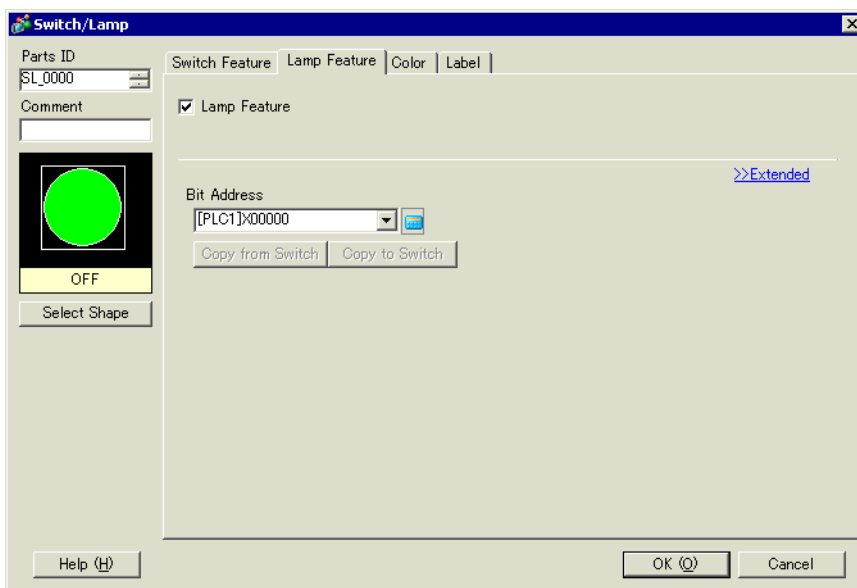

3 In [Select Shape], choose the lamp shape. Click [OK].

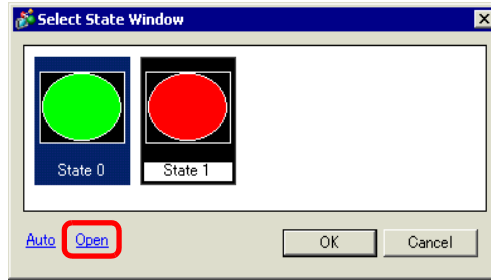

4 Set the bit address to turn ON/OFF the lamp. (For example, X100)

Click the icon to display an address input keypad.

Select the device "X", input "100" in the address, and press the "Ent" key.

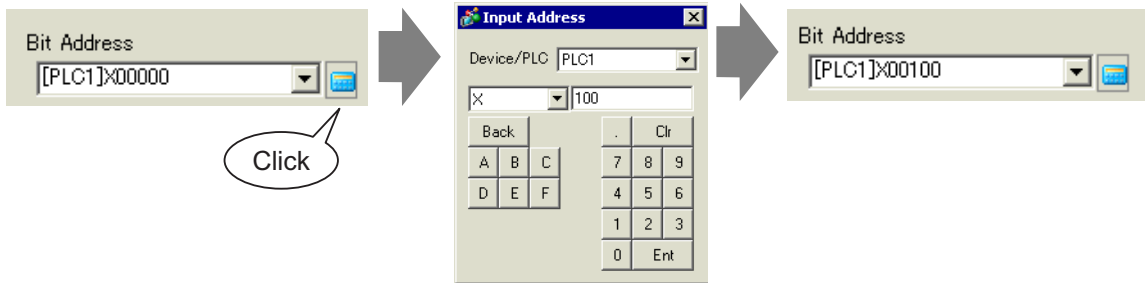

5 Click the [Color] tab. In [Select State], choose ON or OFF, then set the [Display Color], [Pattern], and [Border Color] for each state.

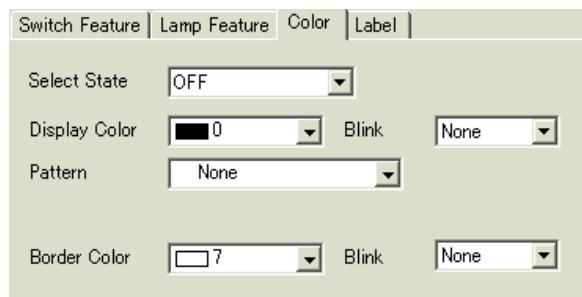

- 6 Click the [Label] tab. Select either [Direct Text] or [Text Table], then specify the font type and size for each selected state. Type the text to display then click [OK].

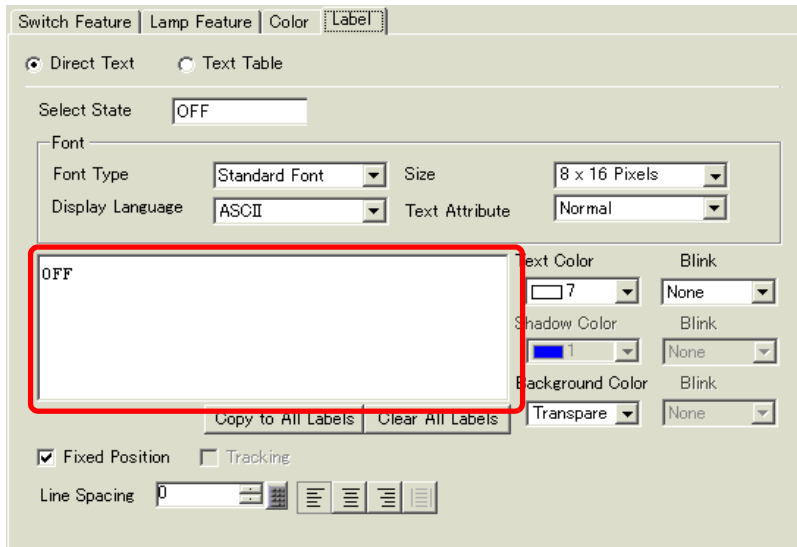

The process is complete.

## 13.3 Switching by Turning Multiple Bits ON/OFF (Up to 5 States)

### 13.3.1 Introduction

On the display unit, one lamp can display an ON/OFF state with different colors for each of four bit operations of a device/PLC.

In the following example, one lamp with different colors on the GP displays a total of four bits, including the crane movement directions (Right, Left and Stop), the error notice bit, and the state with all bits OFF.

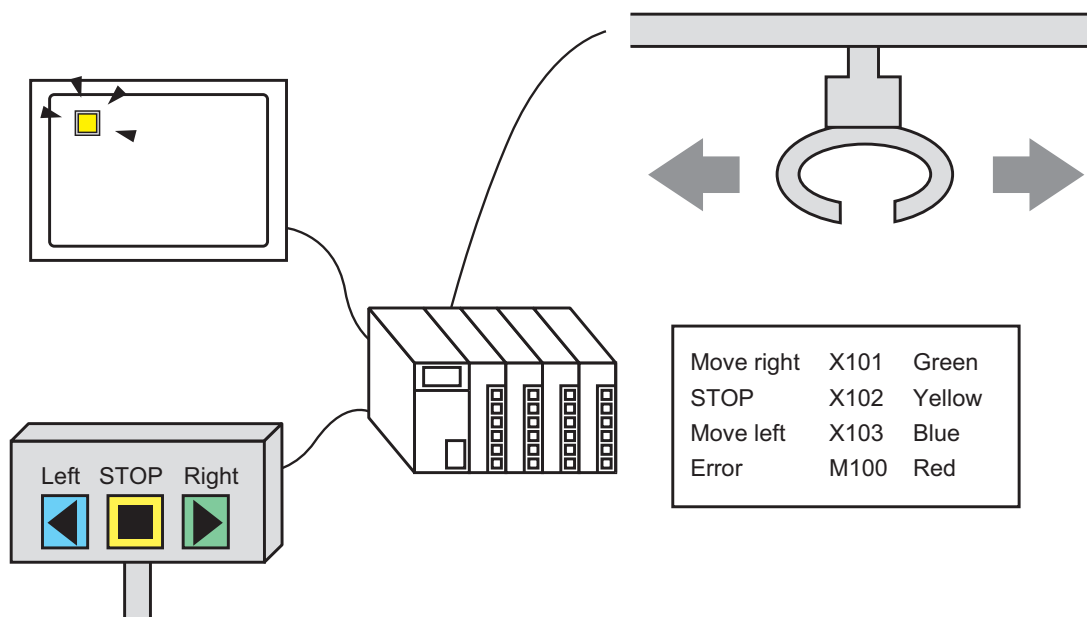

#### IMPORTANT

- If the state display is set to [Interlock Feature] or [Delay Feature], then [Interlock Condition Display] has the highest priority followed by [In-Delay Status Display]. Consequently, the lamp may not be displayed as expected. You can access this option from the [Switch/Lamp] dialog box, select the [Switch Common] tab and then select [Detail].
- The four bit addresses specified to one lamp can be the bit addresses in different devices/PLCs.



### 13.3.2 Setup Procedure

**NOTE**

- Please refer to the settings guide for details.
  - ☞ “13.8 Lamp Settings Guide” (page 13-30)
- For details of the part placement method and the address, shape, color, and label setting method, refer to the "Part Editing Procedure".
  - ☞ “9.6.1 Editing Parts” (page 9-38)

On the display unit, one lamp can display an ON/OFF state with different colors for each of four bit operations of a device/PLC.

In the following example, one lamp with different colors on the GP displays a total of four bits, including the crane movement directions (Right, Left and Stop), the error notice bit, and the state with all bits OFF.

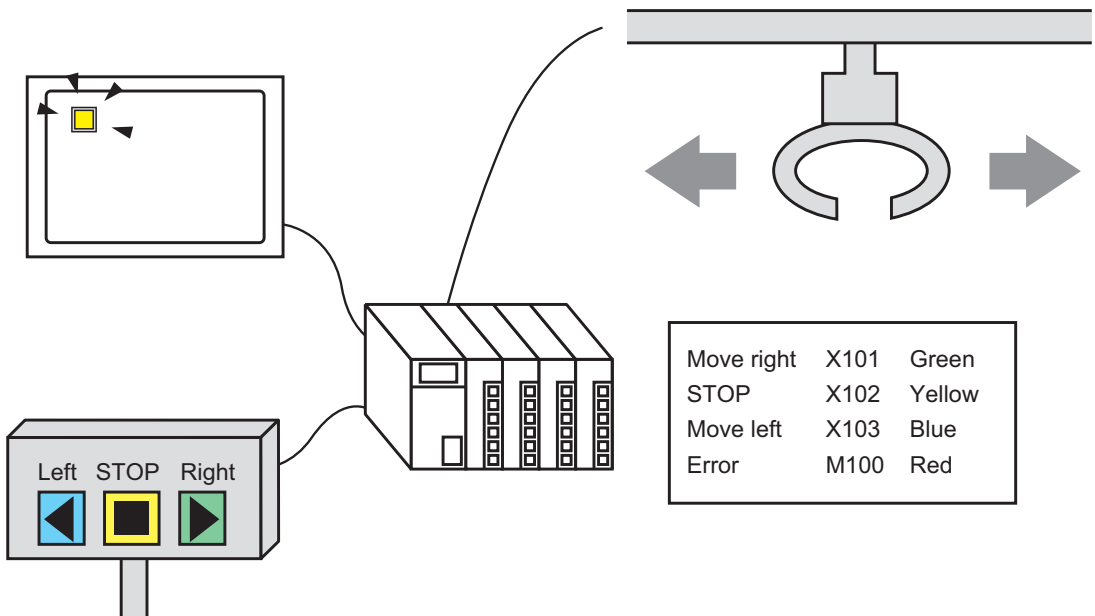

- 1 From the [Parts (P)] menu, point to [Switch Lamp (C)] and select [Lamp (L)] or click  from the toolbar. Place the Part on the screen.

2 Double-click the placed lamp. The Switch/Lamp dialog box appears.

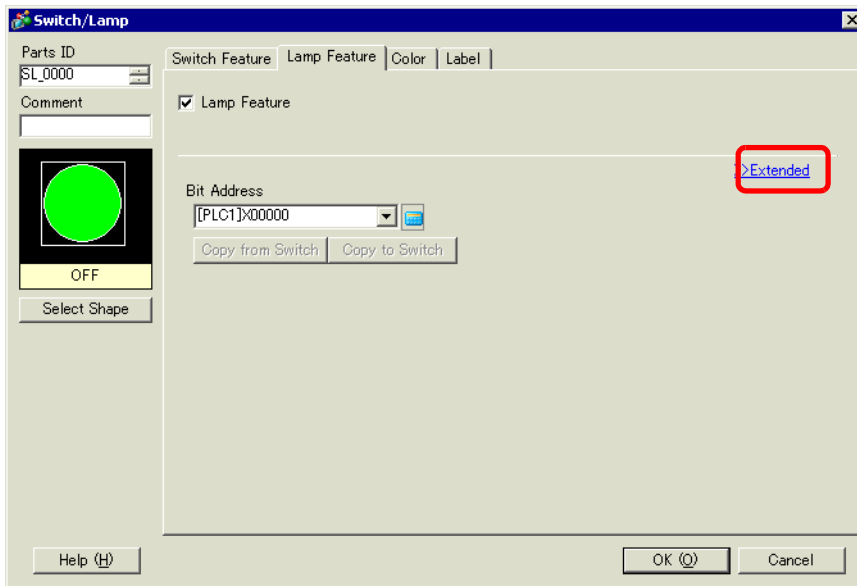

3 Set the [Number of States] and [State Switch Condition]. Setting the [Number of States] to 3 or more allows you to set [State Switch Condition]. (For example, [Number of States] 5, [State Switch Condition] Change Condition by Bit)

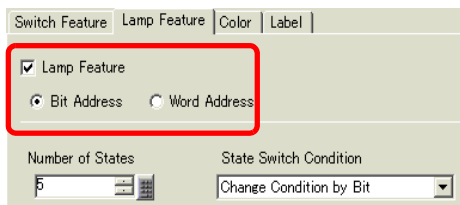

4 Set [Bit Address 1]. In the [Input Address] dialog box, select the device/PLC and set X101 to the device address, and click [Ent]. (For example, X101).

Click the icon to display an address input keypad.

Select the device "X", input "101" in the address, and press the "Ent" key.

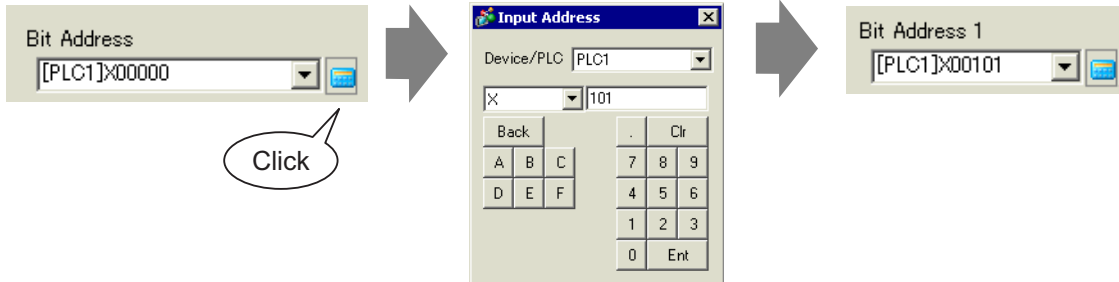

5 Also, set [Bit Address 2] to [Bit Address 4] as follows.  
(For example [Bit Address 2] X102, [Bit Address 3] X103, [Bit Address 4] M100)

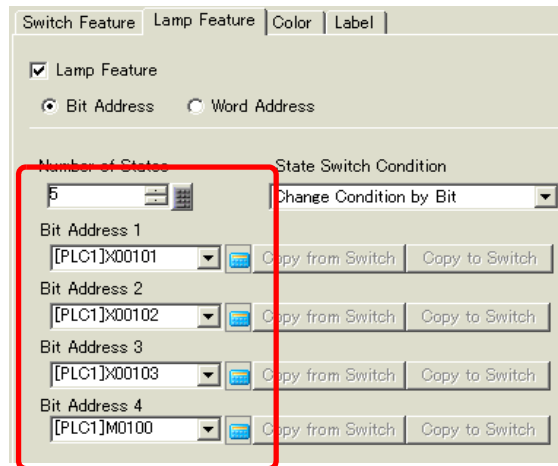

**IMPORTANT**

- Each [State] is defined as the ON (1)/OFF (0) of the corresponding bit address.

State	Description			
	Bit Address 4	Bit Address 3	Bit Address 2	Bit Address 1
[State 0]	0	0	0	0
[State 1]	0	0	0	1
[State 2]	0	0	1	0
[State 3]	0	1	0	0
[State 4]	1	0	0	0

- When multiple bits turn ON at the same time, a lamp display appears in the ascending order from [Bit Address 1] to [Bit Address 4], giving priority to the smallest number.

## Switching by Turning Multiple Bits ON/OFF (Up to 5 States)

6 In [Select Shape], select the lamp shape for each [State].

7 Click the [Color] tab. Select [State0] in [Select State] and set [Display Color] to set the Lamp display color for each of the five states.[State 0] is the state where the specified bit addresses are "All OFF".

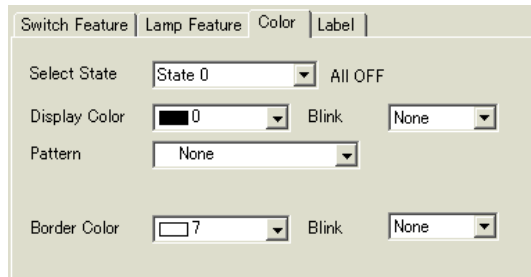

8 Bit Address X101 is ON. [State 1] is the state where the specified Bit Address X101 is ON.

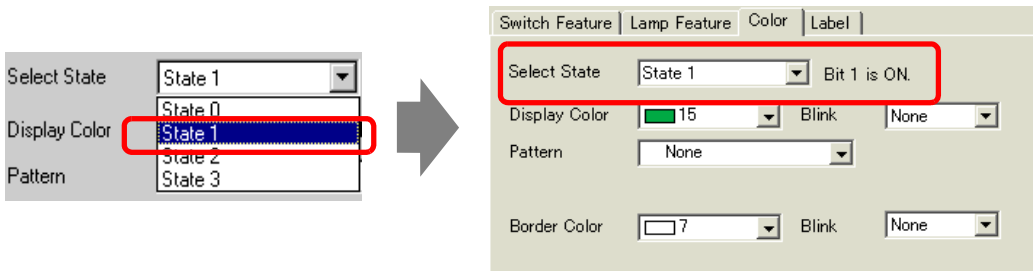

9 Set [Display Color] for [State 2] to [State 4].

10 Click the [Label] tab. Select either [Direct Text] or [Text Table], then specify the font type and size for each selected state. Type the text to display then click [OK].

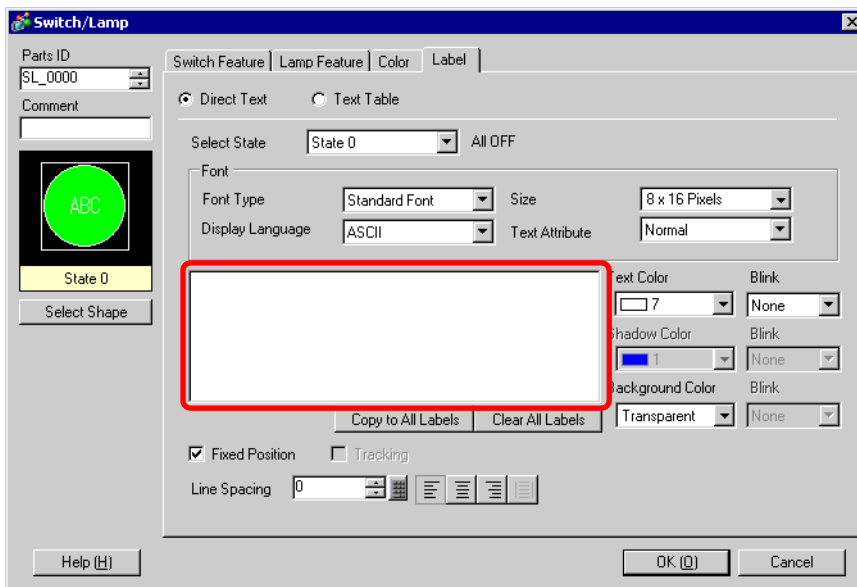

The process is complete.

## 13.4 Switching by a Combination of Multiple Bits (Up to 16 States)

### 13.4.1 Introduction

On the display unit, one lamp can display an ON/OFF state with different colors for each of four bit address combinations of a device/PLC. The resulting 16 [State(s)] are displayed by one lamp with different colors.

In the following example, a lamp displays the 16 combinations of ON/OFF states of bit addresses X101 to X104.

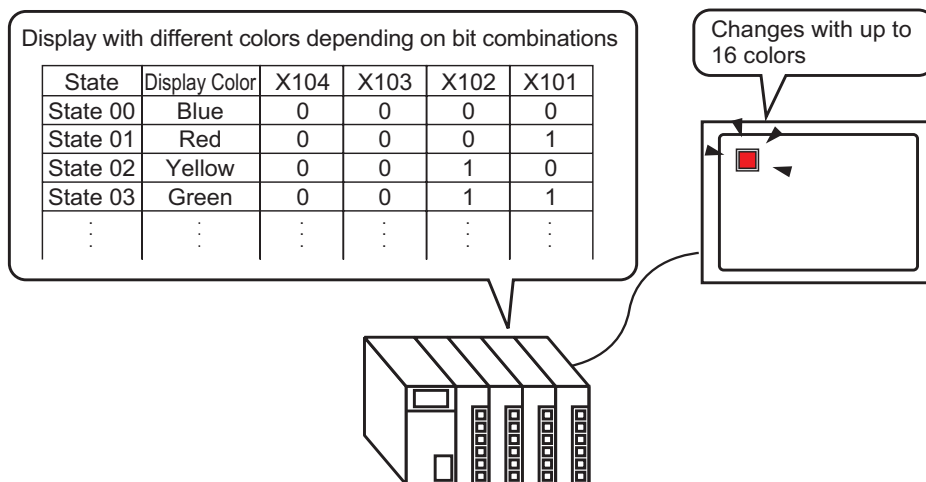
**IMPORTANT**

- If the state display is set to [Interlock Feature] or [Delay Feature], then [Interlock Condition Display] has the highest priority followed by [In-Delay Status Display]. Consequently, the lamp may not be displayed as expected. You can access this option from the [Switch/Lamp] dialog box, select the [Switch Common] tab and then select [Detail].
- The four bit addresses specified to one lamp can be the bit addresses in different devices/PLCs.

## 13.4.2 Setup Procedure

**NOTE**

- Please refer to the settings guide for details.
  - ☞ “13.8 Lamp Settings Guide” (page 13-30)
- For details of the part placement method and the address, shape, color, and label setting method, refer to the "Part Editing Procedure".
  - ☞ “9.6.1 Editing Parts” (page 9-38)

On the display unit, one lamp can display an ON/OFF state with different colors for each of four bit address combinations of a device/PLC. The resulting 16 [State(s)] are displayed by one lamp with different colors.

In the following example, a lamp displays the 16 combinations of ON/OFF states of bit addresses X101 to X104.

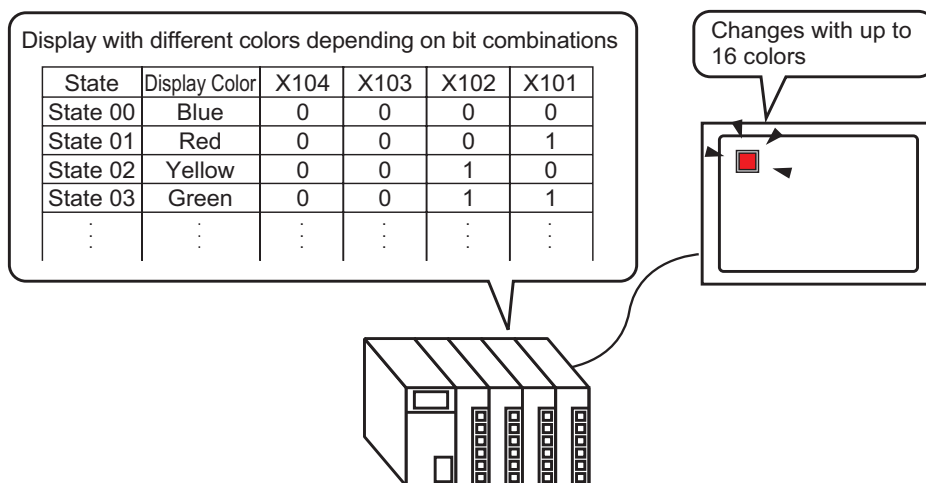

- 1 From the [Parts (P)] menu, point to [Switch Lamp (C)] and select [Lamp (L)] or click  from the toolbar. Place the Part on the screen.

2 Double-click the placed lamp. The Switch/Lamp dialog box appears.

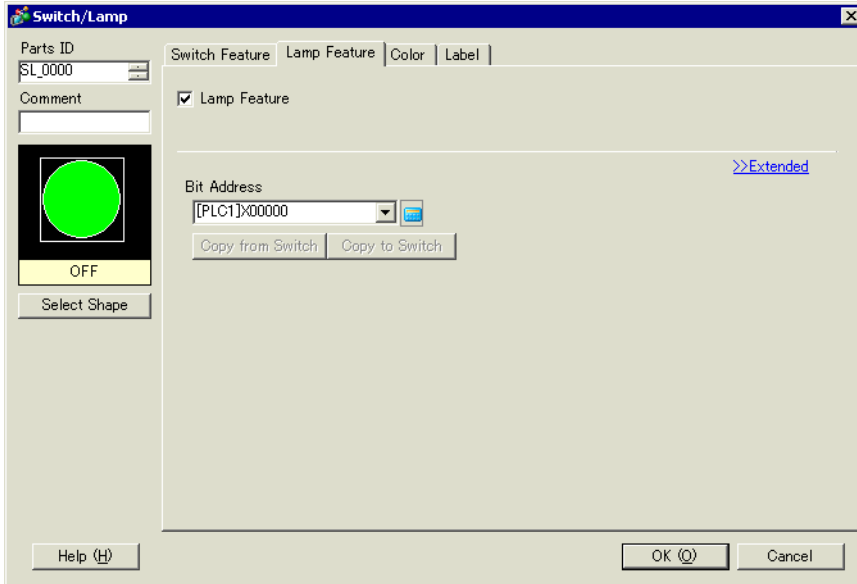

3 Set the [Number of States] and [State Switch Condition]. Setting the [Number of States] to 3 or more allows you to set [State Switch Condition]. (For example, [Number of States] 16, [State Switch Condition] Change Condition by Bit Combination)

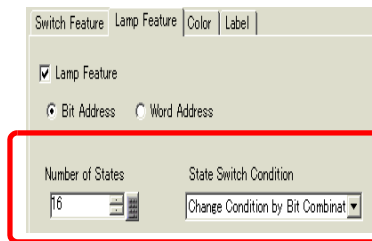

4 Specify the address to display the color coding of the lamp in [Bit Address]. (For example, X101)

Click the icon to display an address input keypad.

Select the device "X", input "101" in the address, and press the "Ent" key.

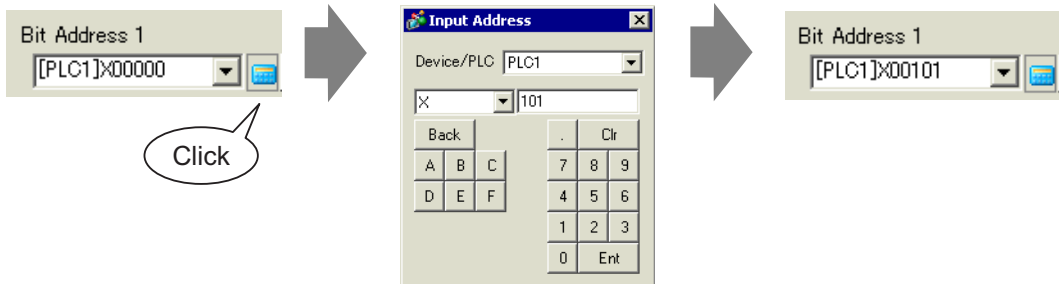

**IMPORTANT**

- Each [State] is defined as the ON (1)/OFF (0) of the corresponding bit address.

State	Description			
	Bit Address 4	Bit Address 3	Bit Address 2	Bit Address 1
[State 0]	0	0	0	0
[State 1]	0	0	0	1
[State 2]	0	0	1	0
[State 3]	0	0	1	1
[State 4]	0	1	0	0
[State 5]	0	1	0	1
[State 6]	0	1	1	0
[State 7]	0	1	1	1
[State 8]	1	0	0	0
[State 9]	1	0	0	1
[State 10]	1	0	1	0
[State 11]	1	0	1	1
[State 12]	1	1	0	0
[State 13]	1	1	0	1
[State 14]	1	1	1	0
[State 15]	1	1	1	1

- 5 Also, set [Bit Address 2] to [Bit Address 4] as follows.  
 (For example [Bit Address 2] X102, [Bit Address 3] X103, [Bit Address 4] X104)

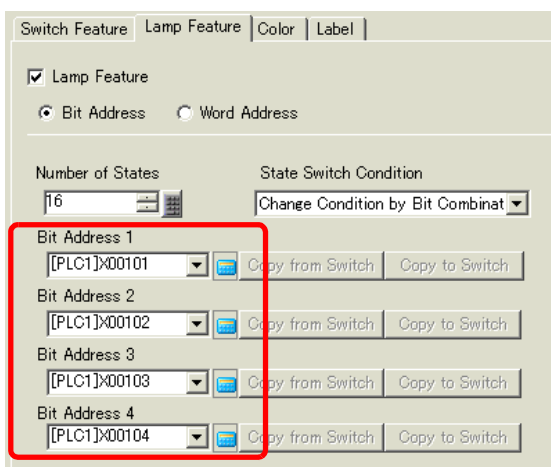

- 6 In [Select Shape], select the lamp shape for each [State].



7 Click the [Color] tab. Select [State0] in [Select State] and set [Display Color] to set the Lamp display color for each of the 16 states.

[State 0] is the state where the specified bit addresses are "All OFF".

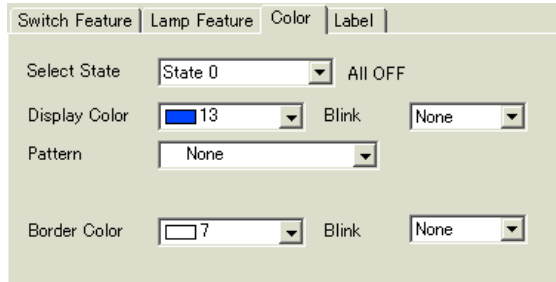

8 Bit Address X101 is ON. [State 1] is the state where the specified Bit Address X101 is ON.

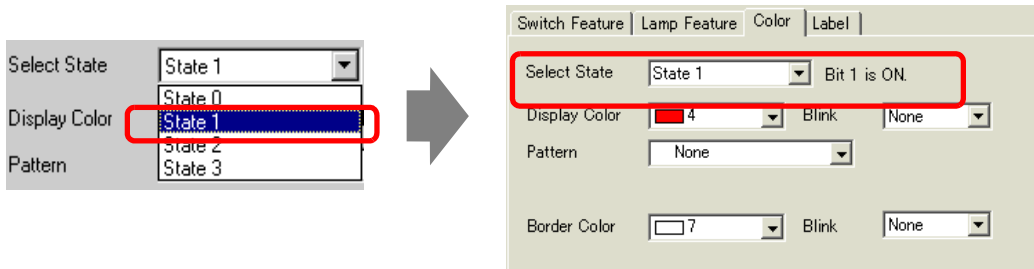

9 Set the display colors for [State 2] to [State 15].

10 Click the [Label] tab. Select either [Direct Text] or [Text Table], then specify the font type and size for each selected state. Type the text to display then click [OK].

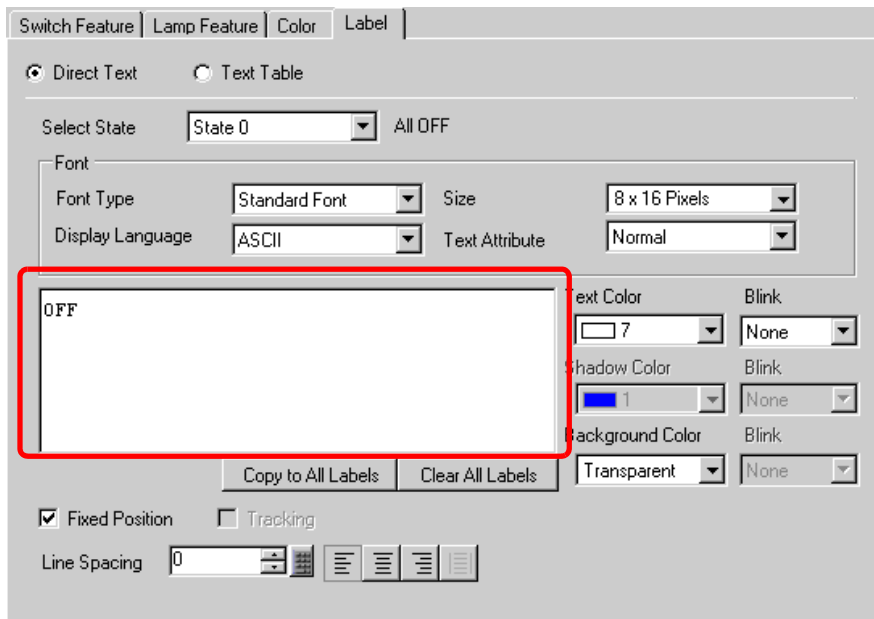

## 13.5 Switching by the Word Address Bit Change (Bit Settings)

### 13.5.1 Introduction

On the GP, one lamp can display with different colors each of the 16 bits of a Word address on a device/PLC.

In the following example, the error information connected to a device/PLC is allocated to each bit of Word address D100. Each error is displayed with a different color according to the allocated bit with one lamp on the GP.

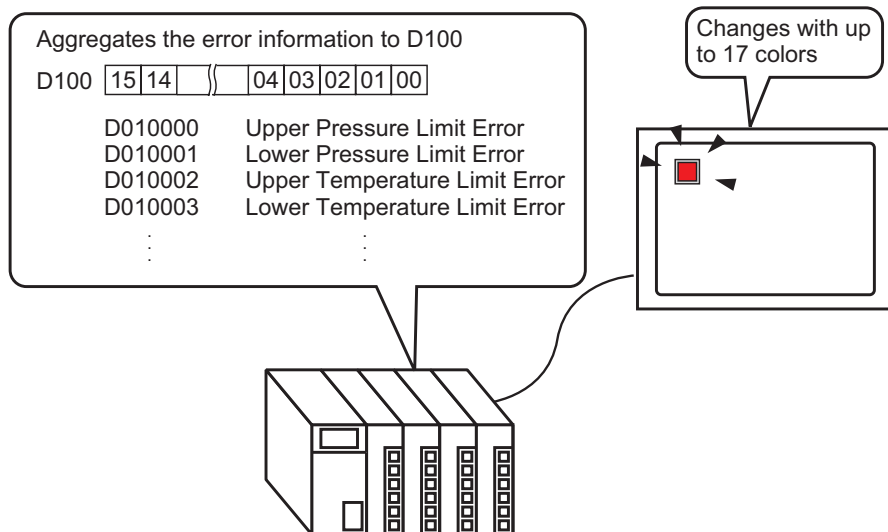

#### IMPORTANT

- If the state display is set to [Interlock Feature] or [Delay Feature], then [Interlock Condition Display] has the highest priority followed by [In-Delay Status Display]. Consequently, the lamp may not be displayed as expected. You can access this option from the [Switch/Lamp] dialog box, select the [Switch Common] tab and then select [Detail].

## 13.5.2 Setup Procedure

**NOTE**

- Please refer to the settings guide for details.  
 ☞ "13.8 Lamp Settings Guide" (page 13-30)
- For details of the part placement method and the address, shape, color, and label setting method, refer to the "Part Editing Procedure".  
 ☞ "9.6.1 Editing Parts" (page 9-38)

On the GP, one lamp can display with different colors each of the 16 bits of a Word address on a device/PLC.

In the following example, the error information connected to a device/PLC is allocated to each bit of Word address D100. Each error is displayed with a different color according to the allocated bit with one lamp on the GP.

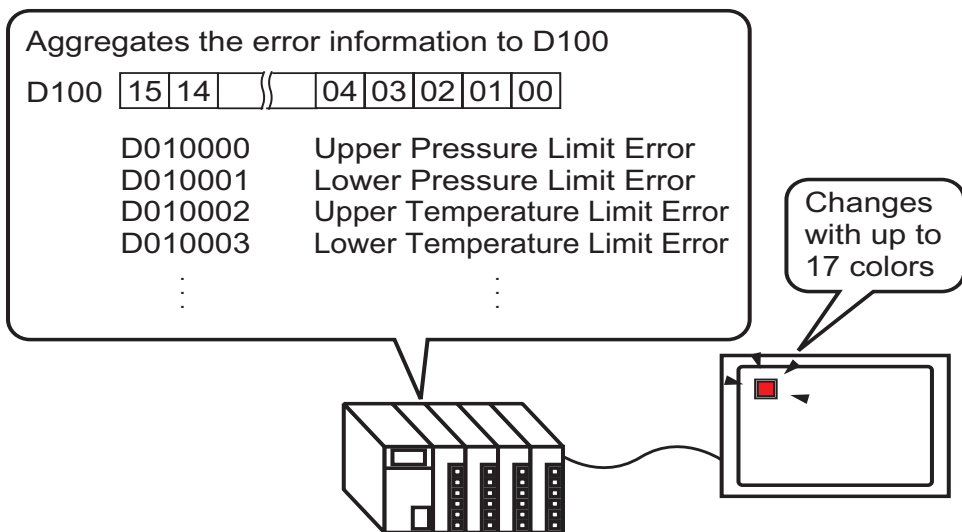

- 1 From the [Parts (P)] menu, point to [Switch Lamp (C)] and select [Lamp (L)] or click  from the toolbar. Place the Part on the screen.

2 Double-click the placed lamp. The Switch/Lamp dialog box appears.

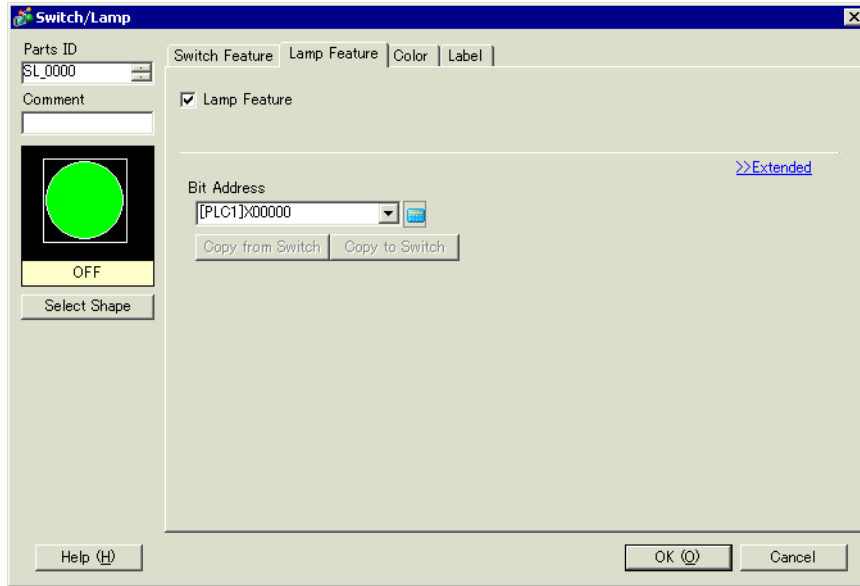

3 Select the [Word Address]. Set the [Number of States] and [State Switch Condition]. Setting the [Number of States] to 3 or more allows you to set [State Switch Condition].

(For example, [Number of States] 17, [State Switch Condition] Change Condition by Bit)

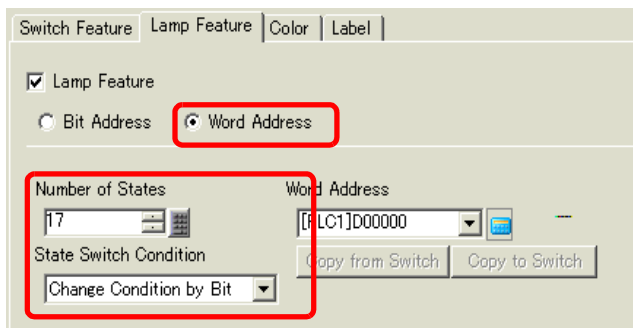

4 Specify the address to display the color coding of the lamp in [Word Address]. (For example, D100)

Click the icon to display an address input keypad.

Select device "D", input "100" as the address, and press the "Ent" key.

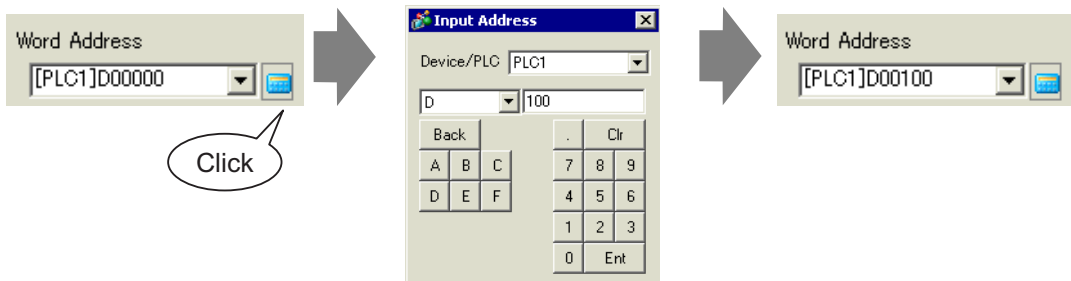

- 5 In [Select Shape], select the lamp shape for each [State].
- 6 Click the [Color] tab. Select [State 0] in [Select State] and set [Display Color] to set the Lamp display color for each of the 17 states. [State 0] is the state where the specified bit addresses are "All OFF".

**IMPORTANT**

- Each [State] is defined as the ON (1)/OFF (0) of the corresponding bit address.

State	Description
[State 0]	All 0
[State 1]	Only Bit 00 is 1.
[State 2]	Only Bit 01 is 1.
[State 3]	Only Bit 02 is 1.
[State 4]	Only Bit 03 is 1.
[State 5]	Only Bit 04 is 1.
[State 6]	Only Bit 05 is 1.
[State 7]	Only Bit 06 is 1.
[State 8]	Only Bit 07 is 1.
[State 9]	Only Bit 08 is 1.
[State 10]	Only Bit 09 is 1.
[State 11]	Only Bit 10 is 1.
[State 12]	Only Bit 11 is 1.
[State 13]	Only Bit 12 is 1.
[State 14]	Only Bit 13 is 1.
[State 15]	Only Bit 14 is 1.
[State 16]	Only Bit 15 is 1.

- When multiple bits turn ON at the same time, a lamp display appears in the ascending order from [Bit 0] to [Bit 15], giving priority to the smallest number.

## Switching by the Word Address Bit Change (Bit Settings)

7 In [Select State], select [State 1] and set the [Display Color]. [State 1] is the state where Bit 0 of Word Address D100 is ON.

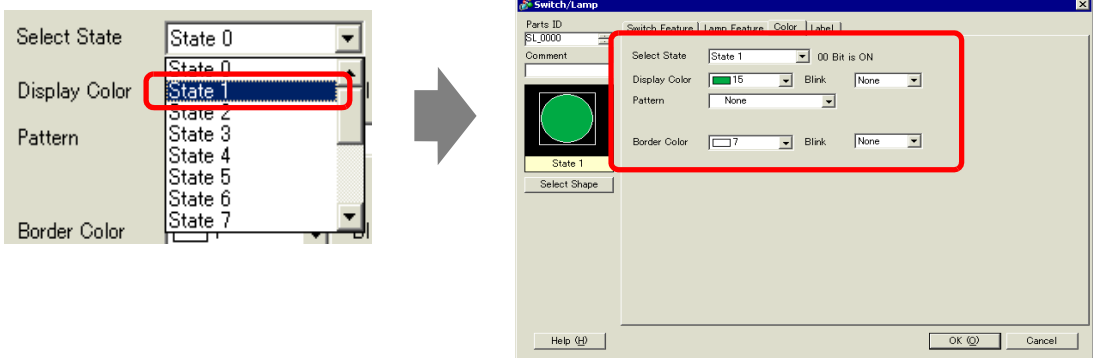

8 Set [Display Color] for states, from [State 2] to [State 16].

9 Click the [Label] tab. Select either [Direct Text] or [Text Table], then specify the font type and size for each selected state. Type the text to display then click [OK].

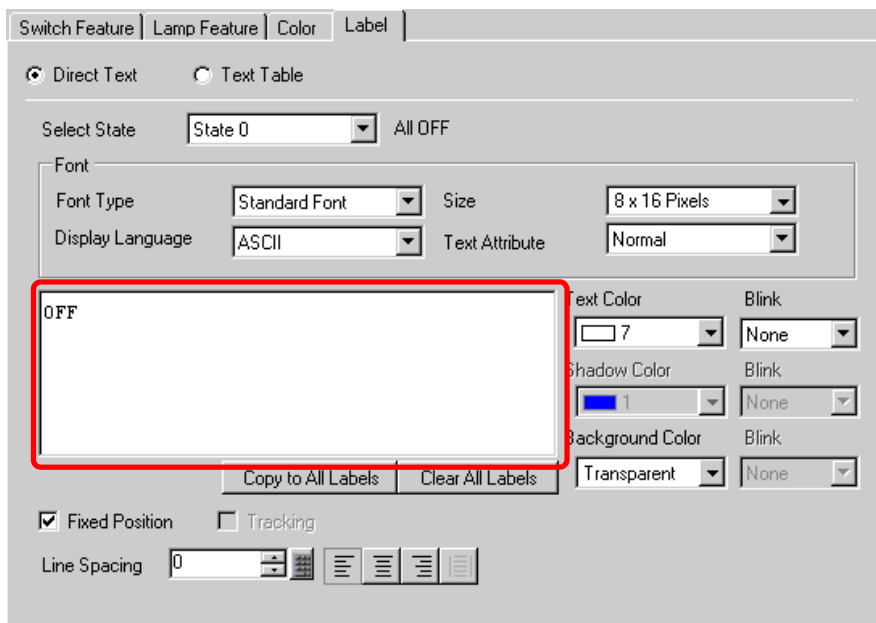

The process is complete.

## 13.6 Switching by Word Address Data Change (Up to 16 States)

### 13.6.1 Introduction

When the data "0 to 15" is found in the Word Address, one lamp displays the state with different colors.

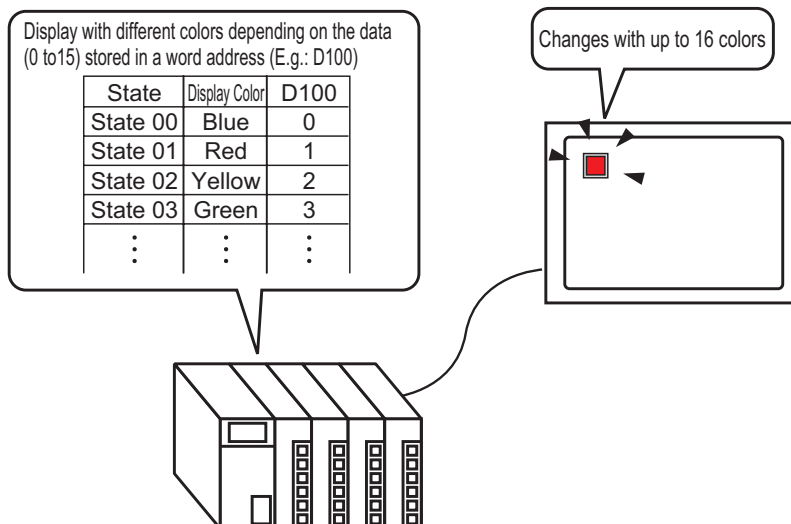

#### IMPORTANT

- If the state display is set to [Interlock Feature] or [Delay Feature], then [Interlock Condition Display] has the highest priority followed by [In-Delay Status Display]. Consequently, the lamp may not be displayed as expected. You can access this option from the [Switch/Lamp] dialog box, select the [Switch Common] tab and then select [Detail].

## 13.6.2 Setup Procedure

**NOTE**

- Please refer to the settings guide for details.
  - ☞ “13.8 Lamp Settings Guide” (page 13-30)
- For details of the part placement method and the address, shape, color, and label setting method, refer to the "Part Editing Procedure".
  - ☞ “9.6.1 Editing Parts” (page 9-38)

The lamp state can be changed by storing a value from 0 to 15 in the specified Word address. Using 00 Bit to 03 Bit of a device/PLC's Word Address, one lamp displays each bit address' combinations of ON/OFF states with different colors on the GP.

In the following example, one lamp on the GP uses different colors to display each of the 16 combinations of ON/OFF states for Bit 00 to Bit 03 of Word address D100.

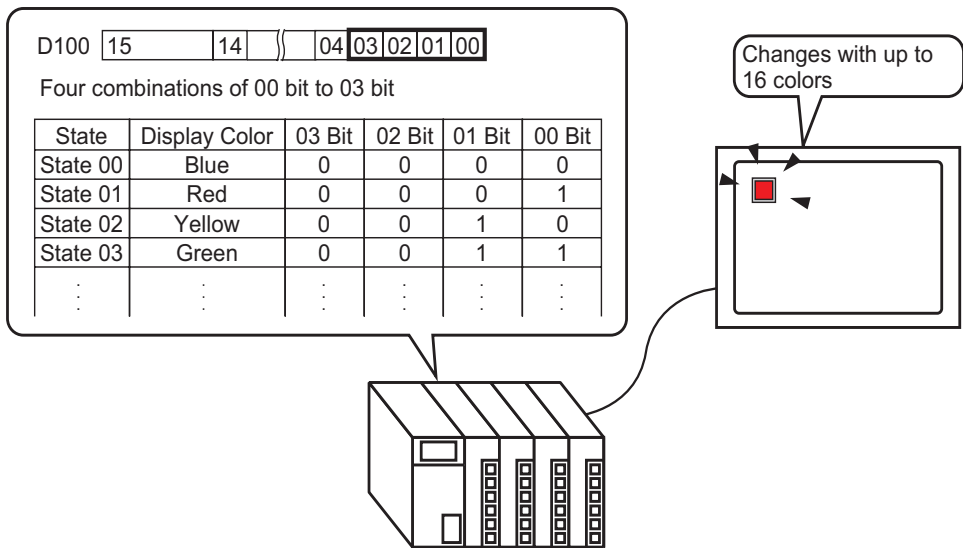

- 1 From the [Parts (P)] menu, point to [Switch Lamp (C)] and select [Lamp (L)] or click  from the toolbar. Place the Part on the screen.



2 Double-click the placed lamp. The Switch/Lamp dialog box appears.

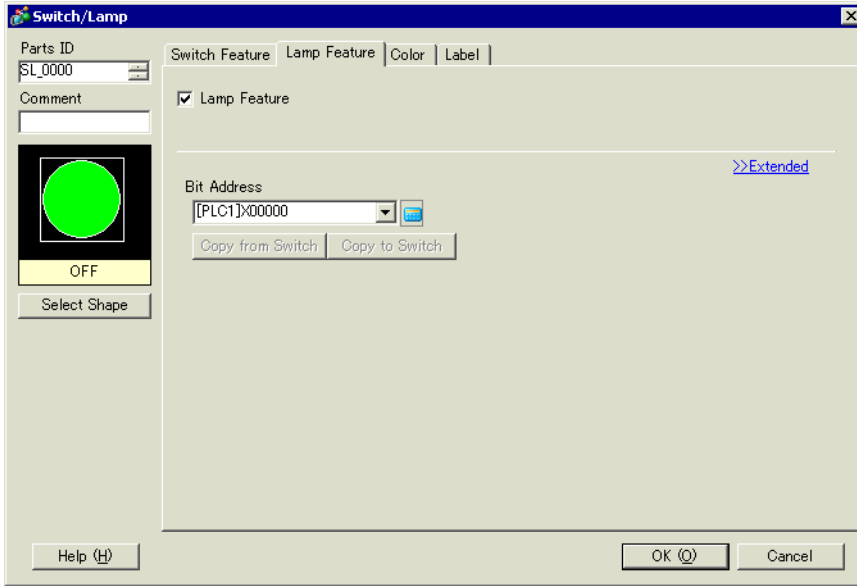

3 Select the [Word Address]. Set the [Number of States] and [State Switch Condition]. Setting the [Number of States] to 3 or more allows you to set [State Switch Condition]. (For example, [Number of States] 16, [State Switch Condition] Change Condition by Data)

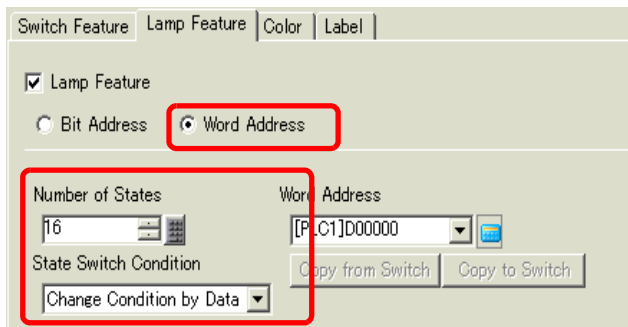

4 Specify the address to display the color coding of the lamp in [Word Address]. (For example, D100)

Click the icon to display an address input keypad.

Select device "D", input "100" as the address, and press the "Ent" key.

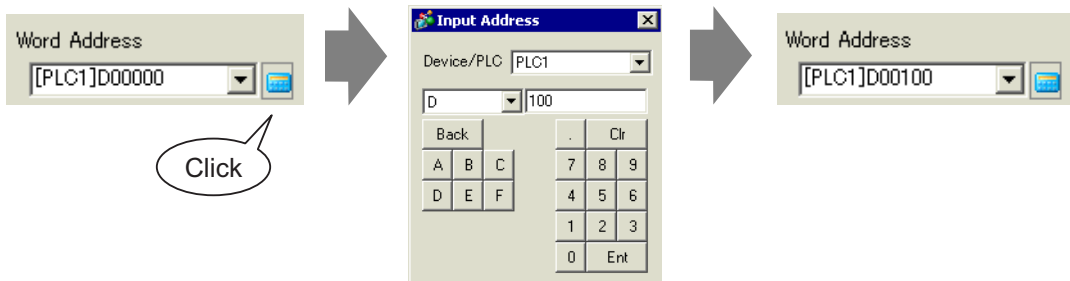

5 In [Select Shape], select the lamp shape for each [State].

6 Click the [Color] tab. Select [State 0] in [Select State] and set [Display Color] to set the Lamp display color for each of the 16 states. [State 0] is the state where the specified bit addresses are "All OFF"

**IMPORTANT**

- Each [State] is defined as the ON (1)/OFF (0) of the corresponding bit address.

State	Description			
	Bit 03	Bit 02	Bit 01	Bit 00
[State 0]	0	0	0	0
[State 1]	0	0	0	1
[State 2]	0	0	1	0
[State 3]	0	0	1	1
[State 4]	0	1	0	0
[State 5]	0	1	0	1
[State 6]	0	1	1	0
[State 7]	0	1	1	1
[State 8]	1	0	0	0
[State 9]	1	0	0	1
[State 10]	1	0	1	0
[State 11]	1	0	1	1
[State 12]	1	1	0	0
[State 13]	1	1	0	1
[State 14]	1	1	1	0
[State 15]	1	1	1	1

- Bits 04 to 15 can be used for another application because they are not used for the [Change Condition by Data].

7 Select [State 1] in [Select State] and set the [Display Color]. [State 1] is the state where the specified Word address D100 stores 1.

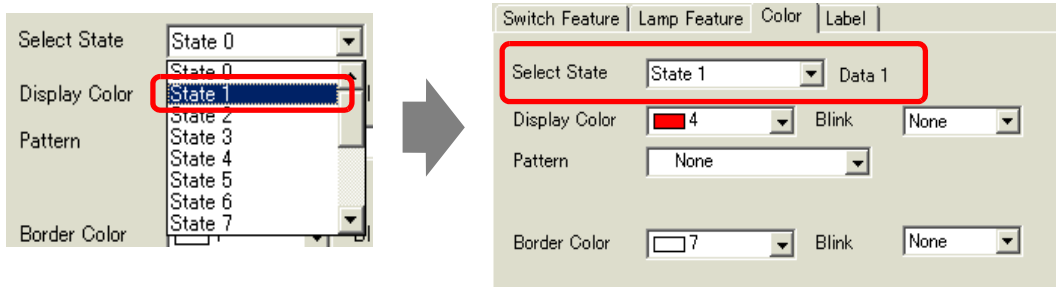

8 Set [Display Color] for states, from [State 2] to [State 15].

9 Click the [Label] tab. Select either [Direct Text] or [Text Table], then specify the font type and size for each selected state. Type the text to display then click [OK].

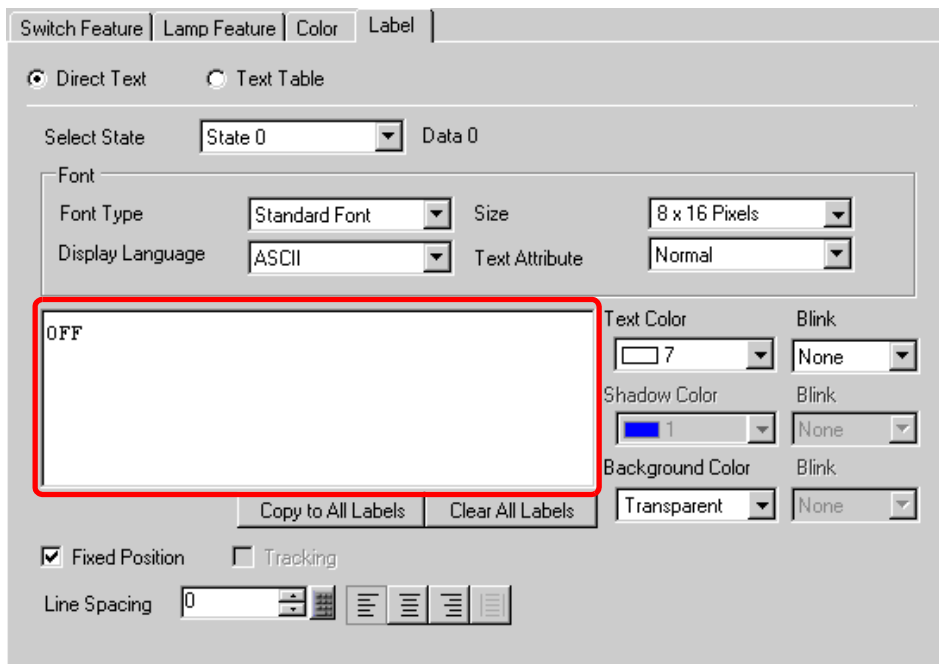

The process is complete.

## 13.7 Procedure for Creating a Lamp

From the [Parts (P)] menu, point to [Switch Lamp (C)] and select [Lamp (L)] or click  from the toolbar. Place the Part on the screen.

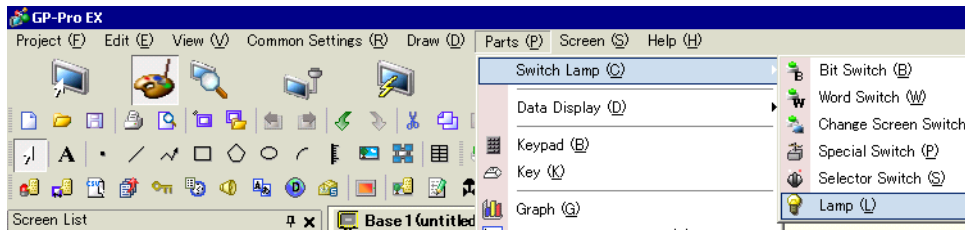

Double-click the placed lamp. The Switch/Lamp dialog box appears.

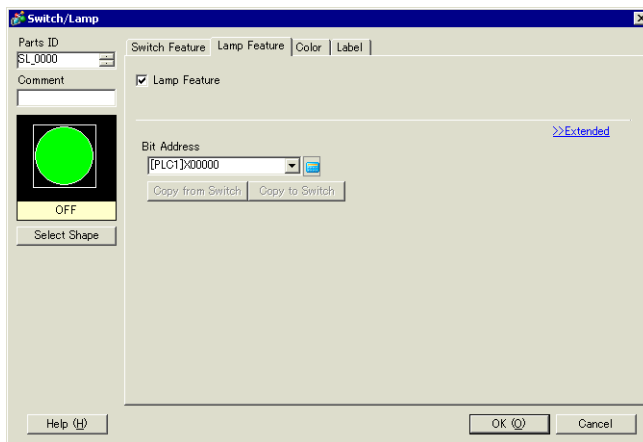

Click [Select Shape]. In the [Select State] dialog box, select a lamp shape. (To use multiple bit addresses or Word addresses, specify [Number of States] and then select the shape of each lamp in [Select Shape].)

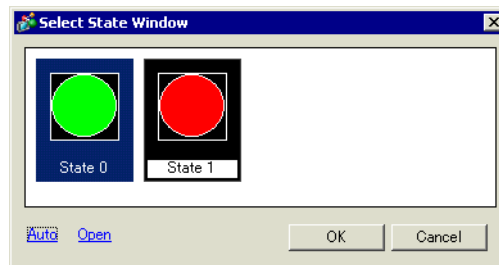

- The shape previously selected for the Switch will apply to both [State 0] and [State 1] after specifying the Lamp Feature settings.



## Procedure for Creating a Lamp

To display the ON/OFF state of a bit address with the lamp, specify the bit address in the [Basic] dialog box.

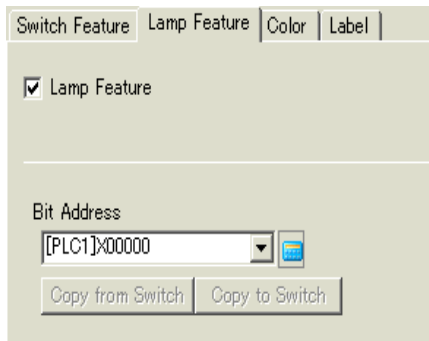

When using multiple bit addresses or Word addresses, click [Details]. Specify the operation condition and bit addresses for the lamp.

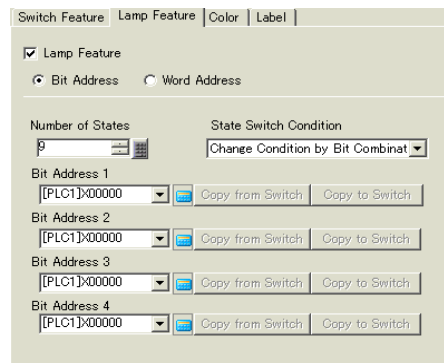

Click the [Color] tab and set the Lamp display colors.



Click the [Label] tab. Select either [Direct Text] or [Text Table]. If you select [Direct Text], specify the font type and size for each selected state. Type the text to display then click [OK].

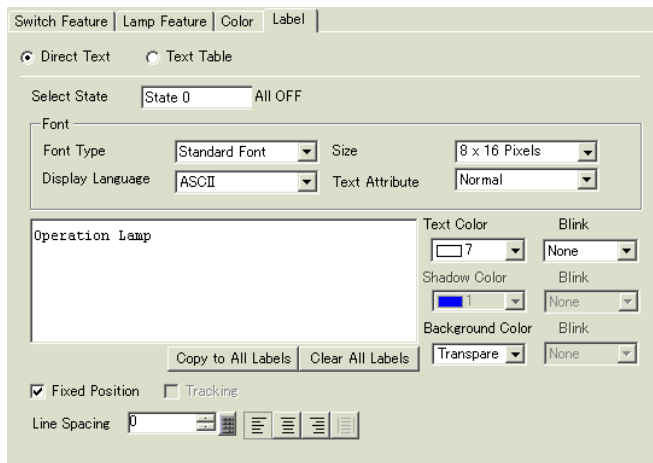



Click [OK] to complete the settings.

## 13.8 Lamp Settings Guide

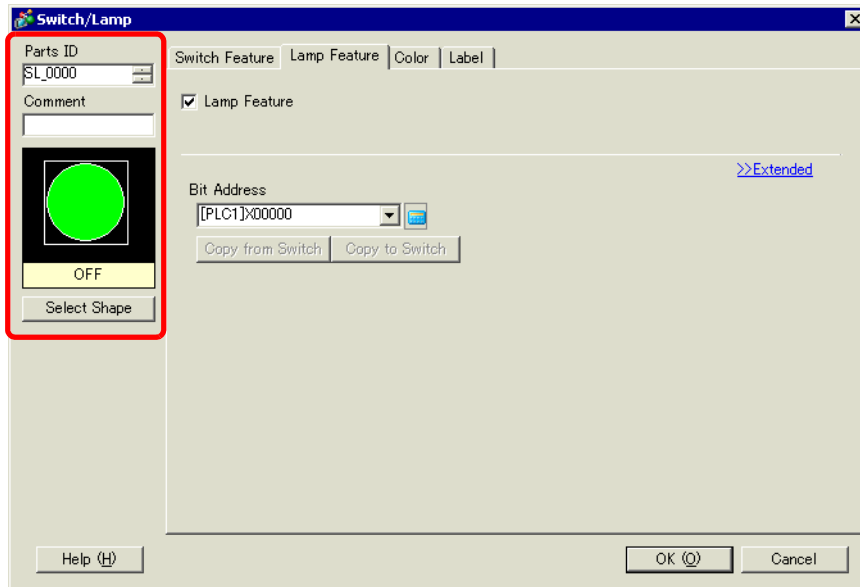
### 13.8.1 Common to All Parts

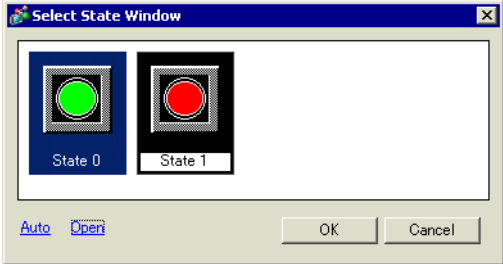
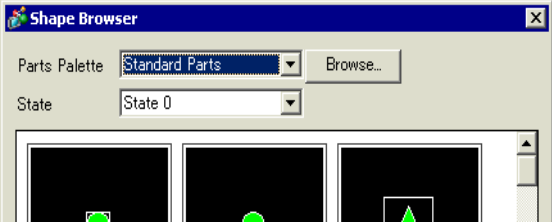

Setting	Description
Part ID	Placed parts are automatically assigned an ID number. Switch lamp part ID : SL_ (4 digits) The letter portion of the ID is fixed and depends on the part. The number portion can be changed. The setting range is from 0000 to 9999.
Comment	The comment for each Part can be up to 20 characters long.

Setting	Description
<p>Select Shape</p>	<p>The part shapes can be changed.</p>  <p>Double-click a part in each state in the [Select State Window], or click [Open] to display the [Shape Browser].</p>  <p>Click  to the right of [Part Palette] or [Reference] to display different Palettes. You can choose from 65536 Colors, 256 Colors, or 64 Colors. Select a Part Palette supported by your model.</p> <p>Depending on the shape, you may not be able to change the color.</p>

## 13.8.2 Lamp Feature

### ■ Basic

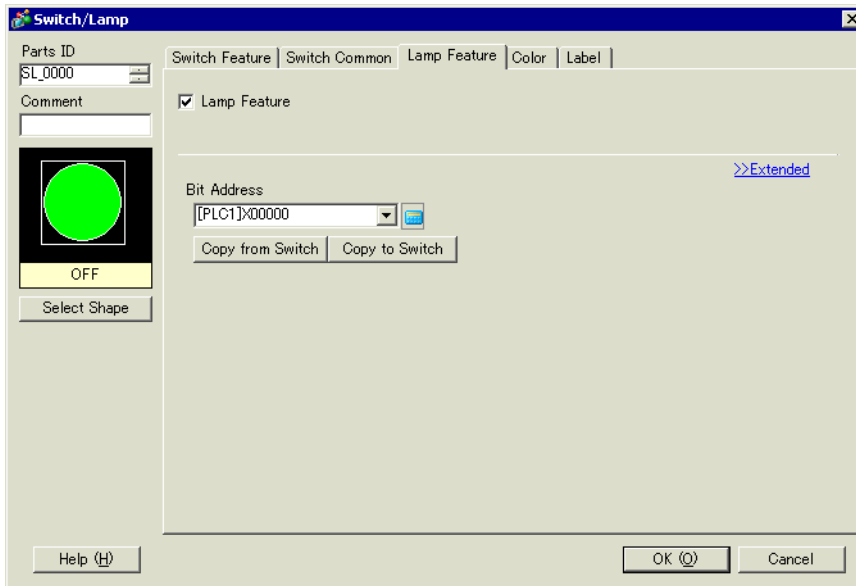

Setting	Description
Lamp Feature	Set whether or not to use the lamp feature.
Bit Address	Specify the bit address to turn ON/OFF the lamp. <ul style="list-style-type: none"> <li>To set three or more colors for a lamp using multiple bit addresses or Word addresses, set them in the [Details] dialog box.</li> </ul> To use multiple bit addresses:  “ ■ Detail (Bit Address)” (page 13-33) To use Word addresses:  “ ■ Detail (Word Address)” (page 13-34)
Copy from Switch	Copies the value from the [Switch Feature] tab's [Bit Address] setting to the [Lamp Feature] tab's [Bit Address]. This is used when setting a Lamp Feature and Switch Feature to the same address.
Copy to Switch	Copies the value from the [Lamp Feature] tab's [Bit Address] setting to the [Switch Feature] tab's [Bit Address]. This is used when setting a Lamp Feature and Switch Feature to the same address.



## ■ Detail (Bit Address)

Select this when using multiple bit addresses.

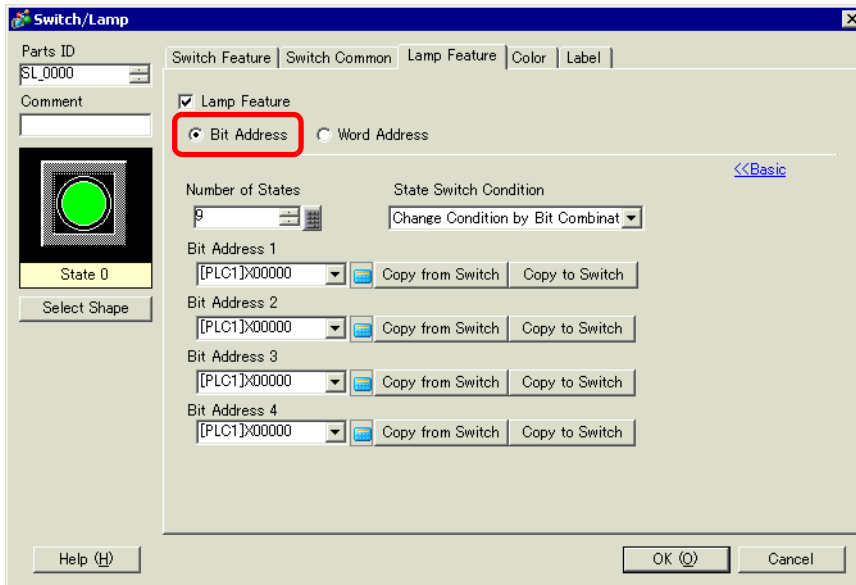

Setting	Description
Number of States	Set the number of the Lamp color states from 2 to 16. To set four colors for one lamp, the number of states is 4.
State Switch Condition	<p>Using four bit devices, one lamp displays the combination of the bit addresses' ON (1)/OFF (0) states with different colors.</p> <ul style="list-style-type: none"> <li>• Change Condition by Bit The color of the lamp is changed according to the ON/OFF state of the individual four bit addresses. ☞ “13.3 Switching by Turning Multiple Bits ON/OFF (Up to 5 States)” (page 13-8)</li> <li>• Change Condition by Bit Combination The color of the lamp is changed according to the combination of the ON/OFF states of the four bit addresses. ☞ “13.4 Switching by a Combination of Multiple Bits (Up to 16 States)” (page 13-13)</li> <li>• This setting is disabled when [Number of States] is 2 or less.</li> </ul>
Bit Address	<p>Specify the bit address to turn ON/OFF the lamp.</p> <ul style="list-style-type: none"> <li>• The number of addresses to set differs according to the specified [Number of States] or [State Switch Condition].</li> </ul>
Copy from Switch	Copies the value from the [Switch Feature] tab's [Bit Address] setting to the [Lamp Feature] tab's [Bit Address]. This is used when setting a Lamp Feature and Switch Feature to the same address.
Copy to Switch	Copies the value from the [Lamp Feature] tab's [Bit Address] setting to the [Switch Feature] tab's [Bit Address]. This is used when setting a Lamp Feature and Switch Feature to the same address.

## ■ Detail (Word Address)

Select this when using a Word address.

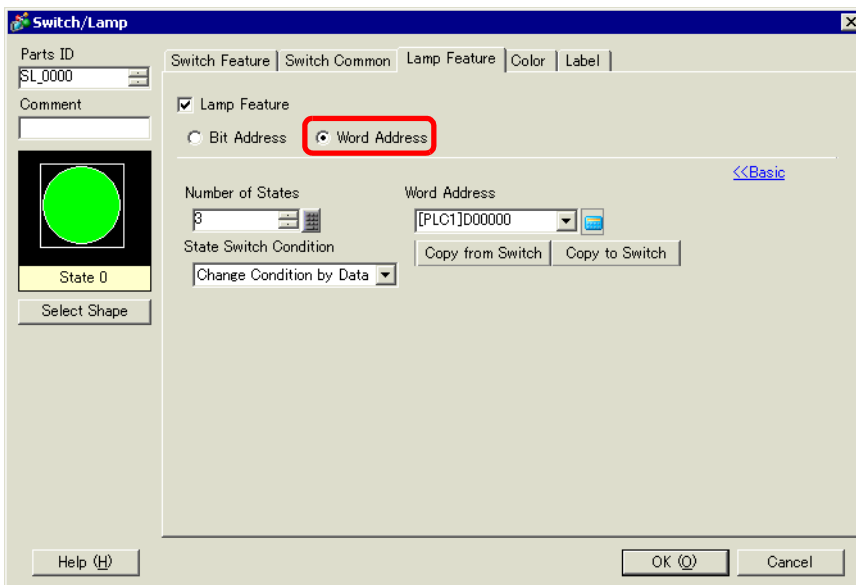

Setting	Description
Number of States	Set the number of the Lamp color states from 2 to 17. To set 17 colors for one lamp, the number of states is 17.
State Switch Condition	Using 16 bit addresses in a Word address, one lamp displays the combination of the bit addresses' ON (1)/OFF (0) states with different colors. <ul style="list-style-type: none"> <li>• Change Condition by Bit The color of the lamp is changed according to the ON/OFF state of the individual 16 bit addresses. ☞ "13.5 Switching by the Word Address Bit Change (Bit Settings)" (page 13-18)</li> <li>• Change Condition by Data The Lamp state can be changed by storing a value from 0 to 15. The color of the lamp is changed according to the ON/OFF status of the higher-order 4 bits in the specified Word address. Up to 16 colors can be set for one lamp. ☞ "13.6 Switching by Word Address Data Change (Up to 16 States)" (page 13-23)</li> <li>• This setting is disabled when [Number of States] is 2 or less.</li> </ul>
Word Address	Specify the Word address to turn ON/OFF the lamp.
Copy from Switch	Copies the value from the [Switch Feature] tab's [Bit Address] setting to the [Lamp Feature] tab's [Bit Address]. This is used when setting a Lamp Feature and Switch Feature to the same address.
Copy to Switch	Copies the value from the [Lamp Feature] tab's [Bit Address] setting to the [Switch Feature] tab's [Bit Address]. This is used when setting a Lamp Feature and Switch Feature to the same address.

### 13.8.3 Color

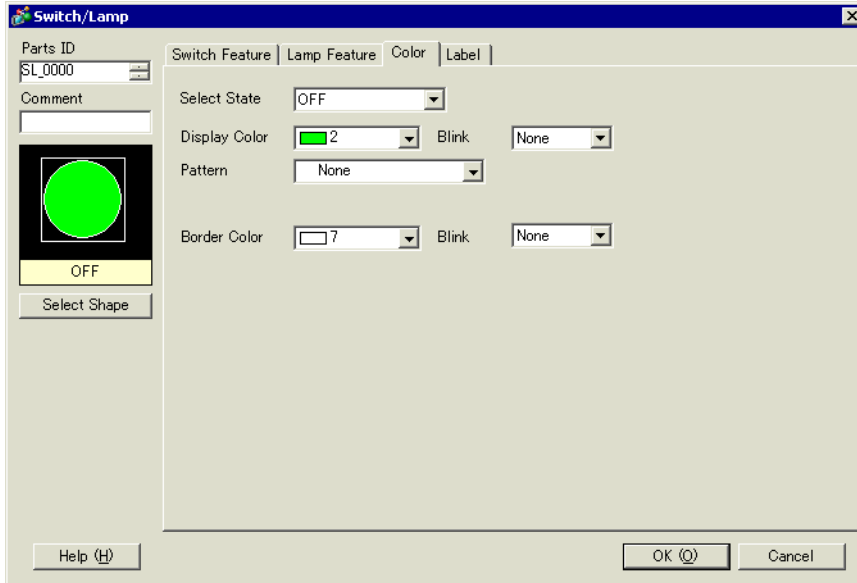

Setting	Description
Select State	<p>Select the Lamp state. Set the color for the Lamp state.</p> <ul style="list-style-type: none"> <li>• OFF You can set the color of the Lamp when OFF.</li> <li>• ON You can set the color of the Lamp when ON.</li> <li>• State 0-State 16 Specify the [Number of States] in the [Lamp Feature]'s detail settings, and then set the color of each of the Lamp states.</li> </ul>
Display Color	Specify the Lamp color.
Pattern	Specify a pattern.
Pattern Color	Select the pattern color for the Lamp.
Border Color	If the Lamp is set to have a border, select a color for it.
Blink	<p>Select whether or not the part will blink, and the blink speed. You can choose different blink settings for the [Display Color], [Pattern Color], and [Border Color].</p> <ul style="list-style-type: none"> <li>• There are cases where you can and cannot set Blink depending on the Main Unit and System Settings' [Color].</li> </ul> <p>👉 “9.5.2 Setting Blinks” (page 9-37)</p>

### 13.8.4 Label

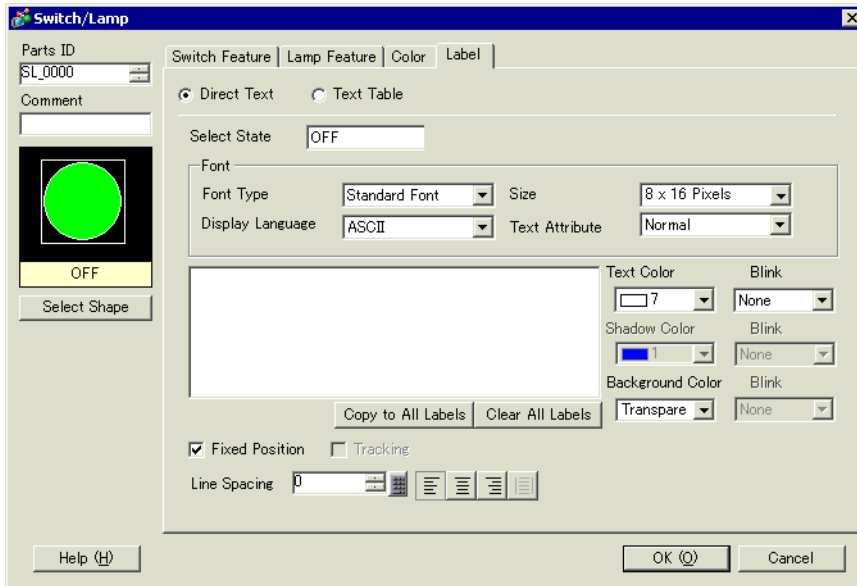



Setting	Description
Text Type	<p>Select the Label's text type.</p> <ul style="list-style-type: none"> <li>• Direct Text Input the text into the text window, and it is placed directly as fixed text.</li> <li>• Text Table Use text from a previously saved Text Table. ☞ "15.4 Changing Languages (Multilanguage)" (page 15-16)</li> </ul>
Select State	<p>Specify the Lamp state. Set the label for the Lamp state.</p> <ul style="list-style-type: none"> <li>• OFF You can set the label of the Lamp when OFF.</li> <li>• ON You can set the label of the Lamp when ON.</li> <li>• State 0-16 Specify the [Number of States] in the [Lamp Feature]'s detail settings, and then set the label of each of the Lamp states.</li> </ul>
Font Type	<p>When [Direct Text] is selected:</p> <ul style="list-style-type: none"> <li>• Standard Font You can select the bitmap font from [ASCII], [Japanese], [Chinese (Traditional)], [Chinese (Simplified)] or [Korean].</li> <li>• The standard font will become bitmap font. The display speed is faster than with other fonts, but characters may have jagged outlines or get out of shape if enlarged/reduced too much.</li> <li>• The Japanese and ASCII standard fonts are transferred to the GP. To use the Chinese (Simplified), Korean, or Chinese (Traditional) standard font, you must add the font in [System Settings/Font]. ☞ "6.2 Defining Stroke Font and Standard Font" (page 6-3)</li> </ul>

Continued

Setting	Description
Font Type	<ul style="list-style-type: none"> <li>• <b>Stroke Font</b> You can select the vector font from [ASCII], [Japanese], [Chinese (Traditional)], [Chinese (Simplified)], [Korean], [Cyrillic], or [Thai].</li> <li>• The stroke font will become vector font. Characters are displayed with smooth outlines if enlarged, but the display speed is slower than with the standard font.</li> <li>• The ASCII stroke font will be transferred to the GP. To use the Japanese, Chinese (Simplified), Korean, Chinese (Traditional), Cyrillic or Thai stroke font, you must add the font in [System Settings/Font]. ☞ "6.2 Defining Stroke Font and Standard Font" (page 6-3)</li> <li>• <b>Image Font</b> Displays a Windows font as bitmap data. ☞ "6.3 Image Font" (page 6-15)</li> </ul> <p>When [Text Table] is selected: Select between Standard Font and Stroke Font.</p>
Character Size	<p>Select the character size. Each font type has a different size range.</p> <ul style="list-style-type: none"> <li>• <b>Character Size</b> Standard Font: 8 x 8 dot standard unit, 1 to 8 times (8 x 8 to 64 x 64 dot) 8 x 16 dot standard unit, 1 to 8 times (8 x 16 to 64 x 128 dot) Stroke Font: 6 to 127</li> <li>• <b>Fixed Size</b> You can select this option only when the [Standard Font] is selected. Select from [6 x 10 dots], [8 x 13 dots], or [13 x 23 dots]. When the [Fixed Size] is "6 x 10 dot", you cannot select [Bold] for the [Text Attribute].</li> </ul>
Display Language	Choose a text display language from [ASCII], [Japanese], [Chinese (Traditional)], [Chinese (Simplified)], [Korean], [Cyrillic], or [Thai].
Text Attribute	Each font type has a different range of styles. Standard Font: Choose from [Standard], [Bold], [Shadow]. Stroke Font: Choose from [Standard], [Bold], [Outline].
Select Font	If [Image Font] is selected from the [Font Type] menu, set [Font], [Font Style], [Text Size], and [Script]. <ul style="list-style-type: none"> <li>• Because Image Font uses a standard Windows popup menu, the available font types, styles, and languages depend on your OS.</li> </ul>
Text (Input Box)	If [Direct Text] is selected, input the text.
Text Color	Set the display color for the text. ☞ "9.5.1 Setting Colors" (page 9-34)
Background Color	Set the background color for the text. ☞ "9.5.1 Setting Colors" (page 9-34)

Continued

Setting	Description
Shadow Color	If the [Font Type] menu - [Standard Font] command and the [Text Attribute] menu - [Shadow] command are selected, set the color for the text shadow.  "9.5.1 Setting Colors" (page 9-34)
Blink	Select whether or not the part will blink, and the blink speed. You can choose different blink settings for the [Text Color], [Shadow Color], and [Background Color]. <ul style="list-style-type: none"> <li>• There are cases where you can and cannot set Blink depending on the Main Unit and System Settings' [Color].</li> </ul>  "9.5.2 Setting Blinks" (page 9-37)
Copy to All Labels	Copies the current [Text] to all the other [Text] states of the Switch. All the other attributes in the [Label] tab will also be copied to the Switch's other states. <ul style="list-style-type: none"> <li>• This can only be set if the Lamp Feature is used.</li> </ul>
Clear All Labels	Clears the [Text] box for all the Switch states. All of the [Label] tab's other attributes, such as Font Type and Color, will remain the same. <ul style="list-style-type: none"> <li>• This can only be set if the Lamp Feature is used.</li> </ul>
Fixed Position	Set whether or not to fix the Label's display position in the center of the part.
Tracking	After the part is placed, any changes made to the Label's size or position will be copied to all the other states. To change the size or position of an individual state's Label without affecting the other states, ensure that this option is not checked. <ul style="list-style-type: none"> <li>• When [Fixed Position] is set, the [Tracking] setting cannot be used.</li> <li>• When [Text Type] is set to [Text Table], the [Tracking] setting cannot be used.</li> </ul>
Row Spacing	Set a row spacing from 0 to 255. This is only applicable when multiple lines are inputted in the [Text]. This option cannot be used when the [Font Type] is set to [Image Font].
Align	Aligns the inputted text. If the text is two lines or more, you can select [Align Left], [Align Right], or [Align Center]. When the [Font Type] is set to [Image Font], [Align on Both Sides] can also be selected.