

14 | Data Display & Data Input

This chapter explains basic features of “Data Display and Input” in GP-ProEX, and basic operations for drawing the Data Display part. Please start by reading “14.1 Settings Menu” (page 14-2) and then turn to the corresponding page.

14.1	Settings Menu	14-2
14.2	Displaying/Inputting Numeric Data	14-5
14.3	Displaying/Inputting Text Data.....	14-8
14.4	Displaying Numerical Data as an Alarm.....	14-12
14.5	Color-coding and Displaying Multiple Ranges	14-17
14.6	Displaying the Date and Time	14-23
14.7	Preventing Operational Errors (Interlock).....	14-26
14.8	Prevent Entering Data Outside the Allowed Range	14-30
14.9	Sequential Input	14-34
14.10	Changing Values by Adding/Subtracting.....	14-38
14.11	Data Display Settings Guide	14-43
14.12	Restrictions	14-103
14.13	How Data Input Order Works	14-106

14.1 Settings Menu

Displaying/Inputting Numeric Data

Displays data stored in a device/PLC

Touch and... Modify data with number pad

☞ Setup Procedure (page 14-6)
☞ Details (page 14-5)

Displaying/Inputting Text Data

Characters displayed

Text data

Word Data

Characters displayed

JAPAN

Touch and... Edit the text

☞ Setup Procedure (page 14-9)
☞ Details (page 14-8)

Word Data

Displaying Numerical Data as an Alarm

Set a numerical data range and...

Invalid ———— OK ———— Invalid

0 Minimum 100 Maximum

D100 = 80

80 Normal color

D100 = 120

120 Alarm color

- ☞ Setup Procedure (page 14-13)
- ☞ Details (page 14-12)

Color-coding and Displaying Multiple Ranges

Set a Plate Color and Numeric Value
Color to each range and...

MIN ———— Blue ———— Yellow ———— MAX

200 500 800

D100 = 300

300 Blue

D100 = 700

700 Yellow

- ☞ Setup Procedure (page 14-18)
- ☞ Details (page 14-17)

Displaying the Date and Time

2005/01/20 (Thu) 09:32

- ☞ Setup Procedure (page 14-24)
- ☞ Details (page 14-23)

Preventing Operational Errors (Interlock)

The Bit Address which disables touch (Interlock Address) turns ON and...

M100:ON

Following the condition...

ON	OFF
Touch	Touch

Input is not accepted

D100 80

What?

- ☞ Setup Procedure (page 14-27)
- ☞ Details (page 14-26)

Prevent Entering Data Outside the Allowed Range

A value set to 80

Data outside the range cannot be input

Input cancelled and old value returns

D100

Beep

Beep Beep Beep

0
100

Input Range

- Setup Procedure (page 14-31)
- Details (page 14-30)

Sequential Input

D100

D101

D102

Input data and touch the [Ent] key

The input is confirmed and the next Data Display part in the input order enters the Input Permit state. → Input data and touch the [Ent] key

- Setup Procedure (page 14-35)
- Details (page 14-34)

Changing Values by Adding/Subtracting

D100

Beep Beep Beep

- Setup Procedure (page 14-39)
- Details (page 14-38)

14.2 Displaying/Inputting Numeric Data

14.2.1 Details

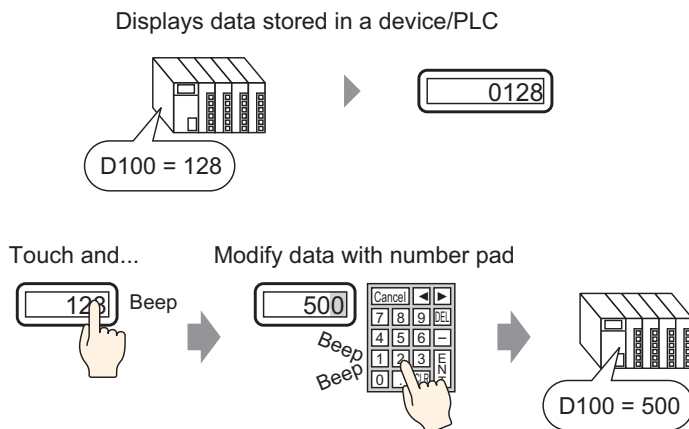



Display data stored in a designated word address in the device (PLC) as a numeric value. Also, by putting Input Permit settings, you can display a number pad on the screen and input data to a designated word address.

14.2.2 Setup Procedure

NOTE

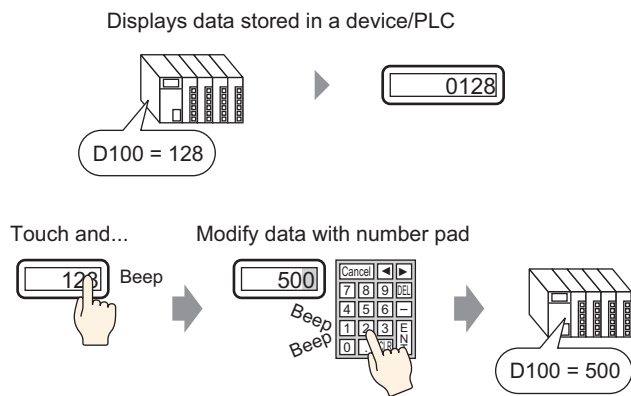
- Please refer to the Setup Guide for details.
 - ☞ “14.11.1 Numeric Display” (page 14-45)
- For details of the part placement method and the address, shape, color, and label setting method, refer to the “Part Editing Procedure”.
 - ☞ “9.6.1 Editing Parts” (page 9-37)



1 On the [Part (P)] menu, point to [Data Display (D)] and then click [Numeric Display (N)], or click the  icon, and place it on the screen.

2 Double-click the placed Data Display and the settings dialog box opens.

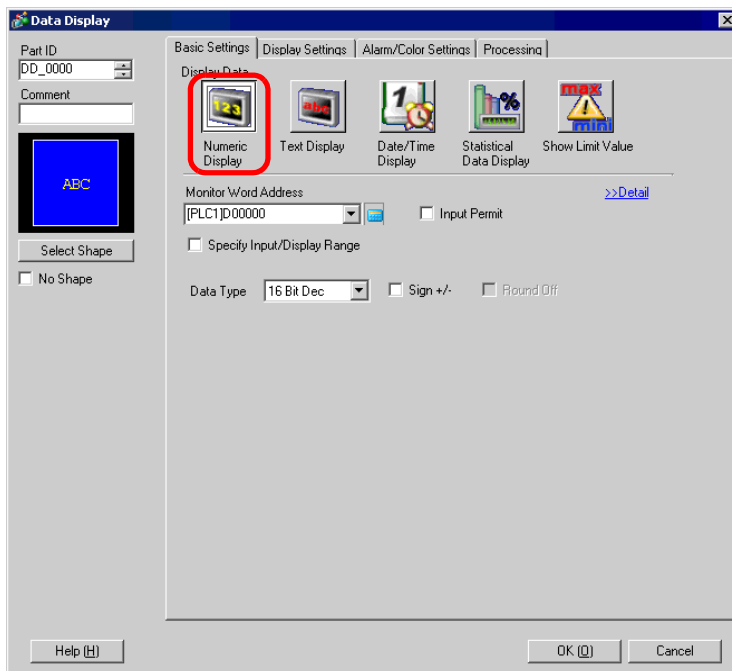

3 Select the Data Display shape from [Select Shape].

4 In [Monitor Word Address], set the address (D100) which will store the value to be displayed.

Click the icon to display an address input keypad.

Select device "D", input "100" as the address, and press the "Ent" key.

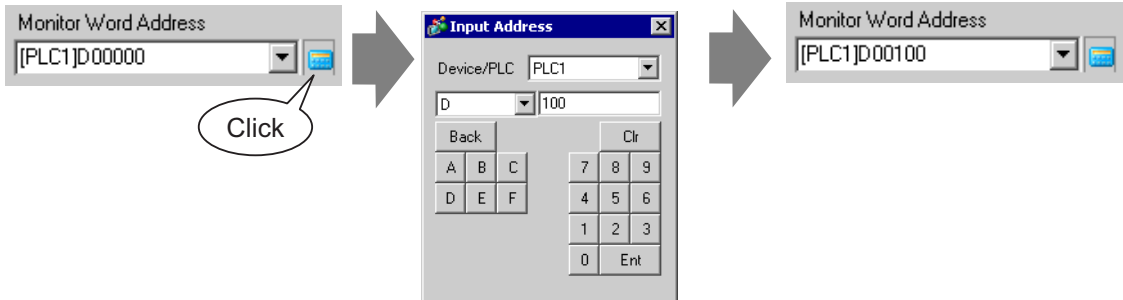

5 Set the type of data that will be displayed (e.g. "16 Bit Dec") in [Data Type].

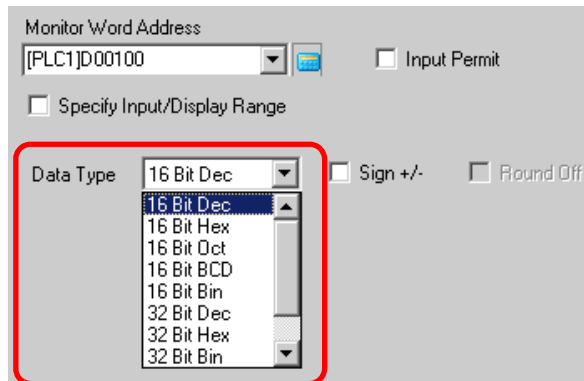

6 Put a check mark next to [Input Permit]. Check [Input Permit] to display the [Input Permit] tab. Check that [Enable Popup Keypad] is checked. You can enter numerical data from the popup keypad.

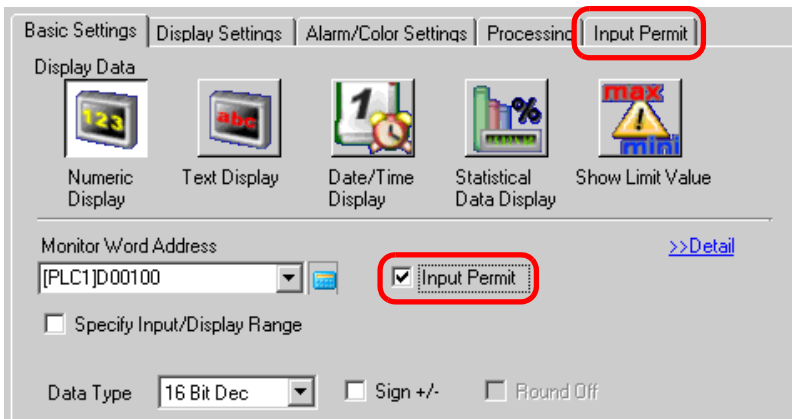

NOTE • This cannot be set when only displaying numeric data.

7 As needed, set the Data Display's color and text on the [Alarm/Color Settings] tab and [Display Settings] tab, and click [OK].

14.3 Displaying/Inputting Text Data

14.3.1 Details

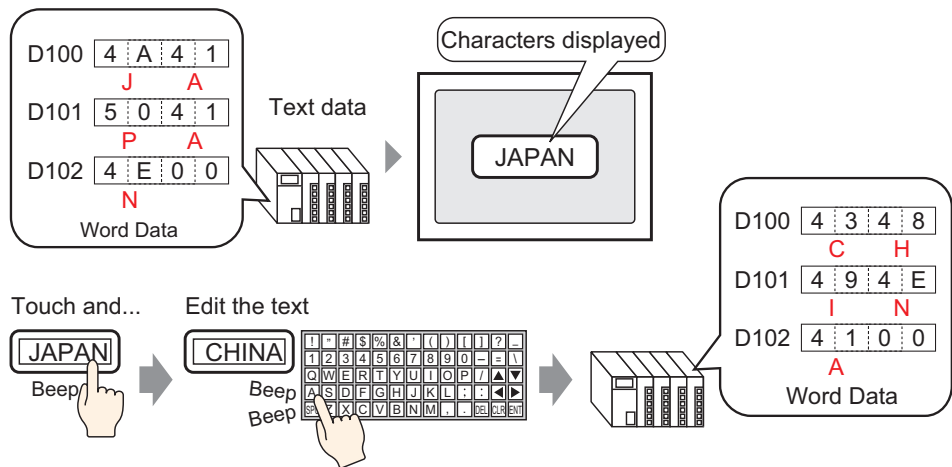

Display text data stored in a specified word address in the device (PLC).

There are two methods for changing Text Data: change the displayed screen, or use a trigger bit.

Also, by putting Input Permit settings, you can display a keypad on the screen and input text data to a designated word address.

14.3.2 Setup Procedure

NOTE

- Please refer to the Setup Guide for details.
 - ☞ “14.11.2 Text Display” (page 14-78)
- For details of the part placement method and the address, shape, color, and label setting method, refer to the “Part Editing Procedure”.
 - ☞ “9.6.1 Editing Parts” (page 9-37)

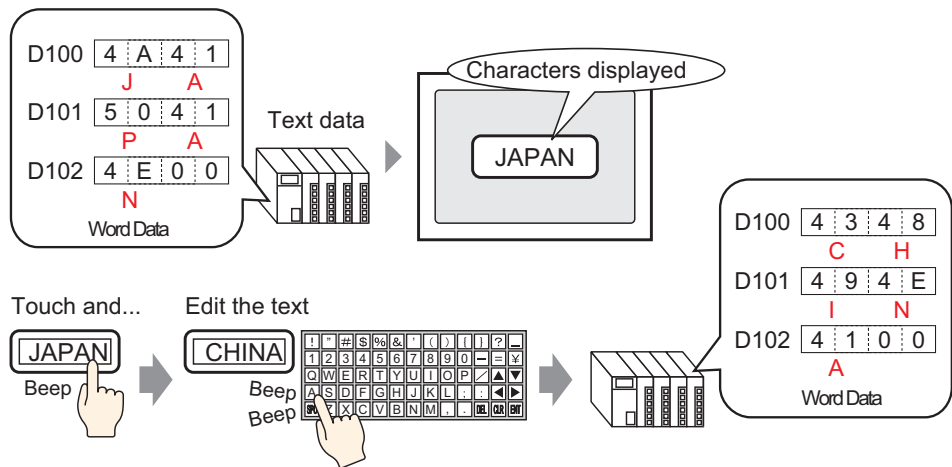

- 1 On the [Part (P)] menu, point to [Data Display (D)] and then click [Text Display (S)], or click , and place it on the screen.

2 Double-click the placed Data Display and the settings dialog box opens.

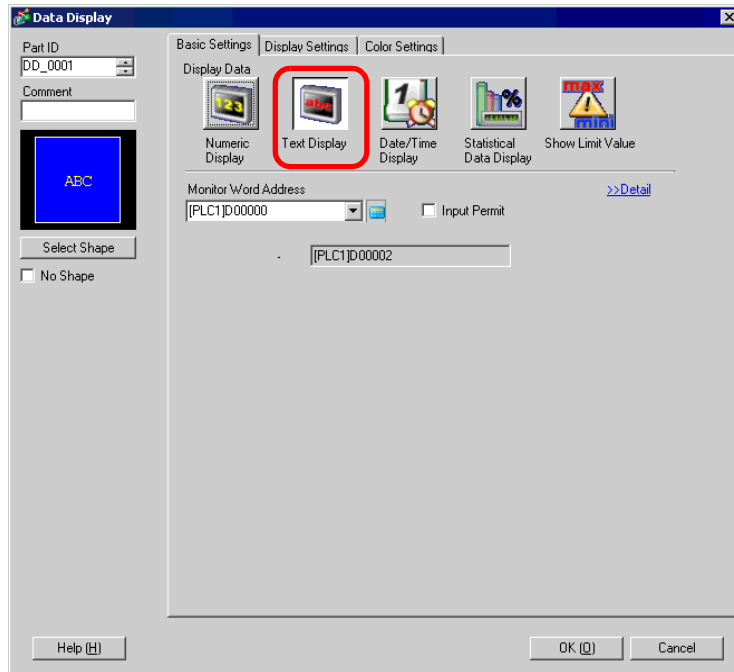

3 Select the Data Display shape from [Select Shape].

4 Click the [Basic Settings] tab and in the [No. of Display Char.] field enter the number of characters from 1 to 100. When working with double-byte characters, each double-byte character counts as two characters.

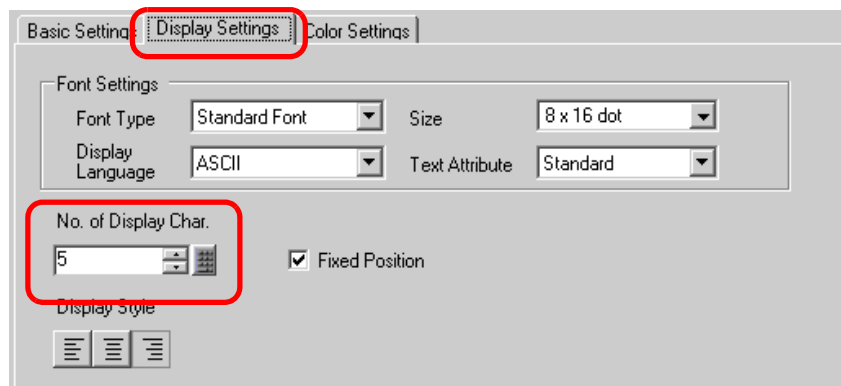

5 Click the [Basic Settings] tab, and in [Monitor Word Address], set the address (D100) which will store the value to be displayed.

Click the icon to display an address input keypad.

Select device "D", input "100" as the address, and press the "Ent" key.

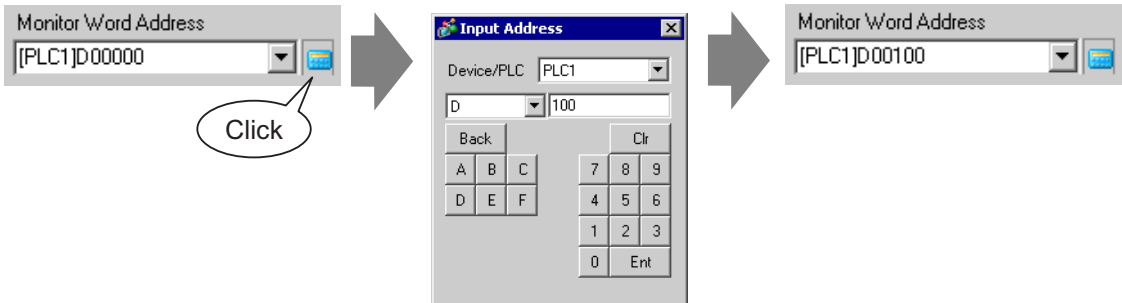

6 The last address of the word address (Monitor Word Address + No. of Display Char.) is displayed.

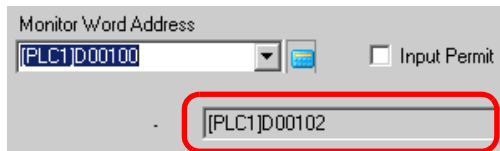

NOTE • One word is used for two single-byte alphanumeric characters or for one-byte character.

7 Put a check mark next to [Input Permit]. Check [Input Permit] to display the [Input Permit] tab. Check that [Enable Popup Keypad] is checked. You can enter text data from the popup keypad.

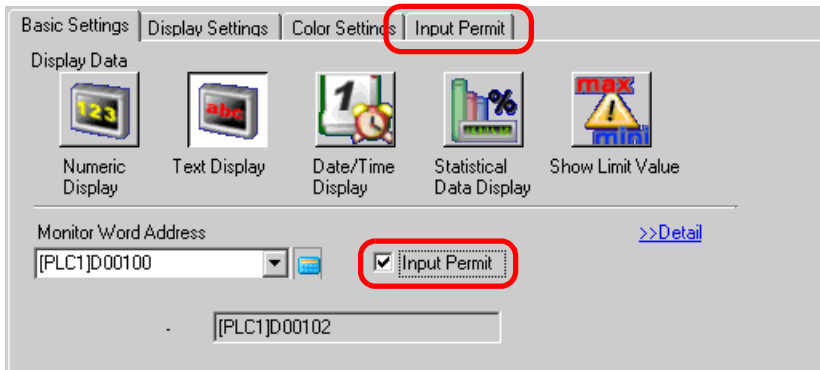

NOTE • This cannot be set when only displaying text data.

8 As needed, set the Data Display's color and text on the [Color Settings] tab and [Display Settings] tab, and click [OK].

NOTE • For more information about Text Displays, refer to "14.12.1 Text Display Restrictions" (page 14-103) .

14.4 Displaying Numerical Data as an Alarm

14.4.1 Details

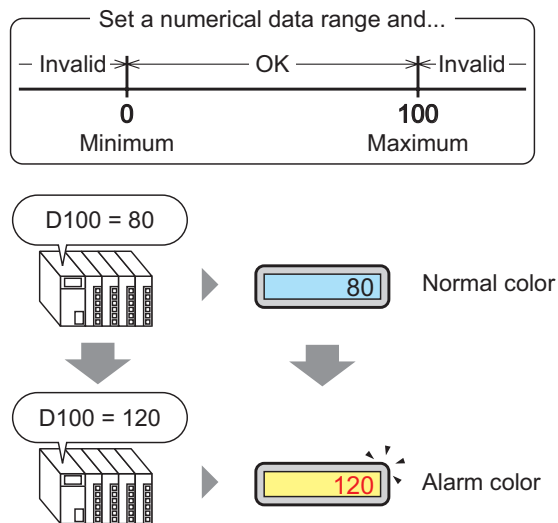

Set a range with preset numeric values.

If the numeric data is outside the range, the display color changes and the user is given notice (e.g. with an alarm).

14.4.2 Setup Procedure

NOTE

- Please refer to the Setup Guide for details.
 - ☞ “14.11.1 Numeric Display ■ Alarm/Color Settings/Basic” (page 14-70)
- For details of the part placement method and the address, shape, color, and label setting method, refer to the “Part Editing Procedure”.
 - ☞ “9.6.1 Editing Parts” (page 9-37)

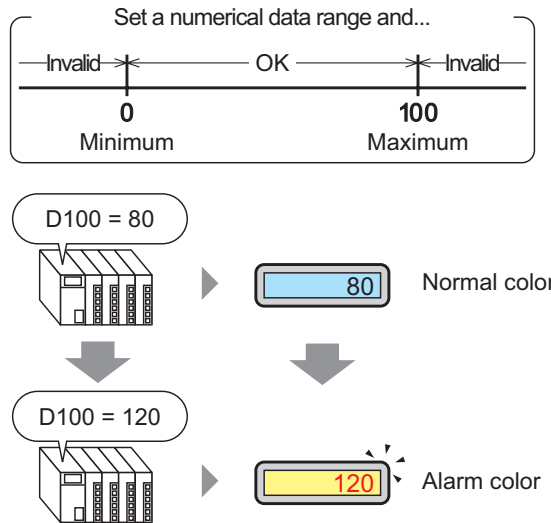

- 1 On the [Part (P)] menu, point to [Data Display (D)] and then click [Numeric Display (N)], or click the  icon, and place it on the screen.

2 Double-click the placed Data Display and the settings dialog box opens.

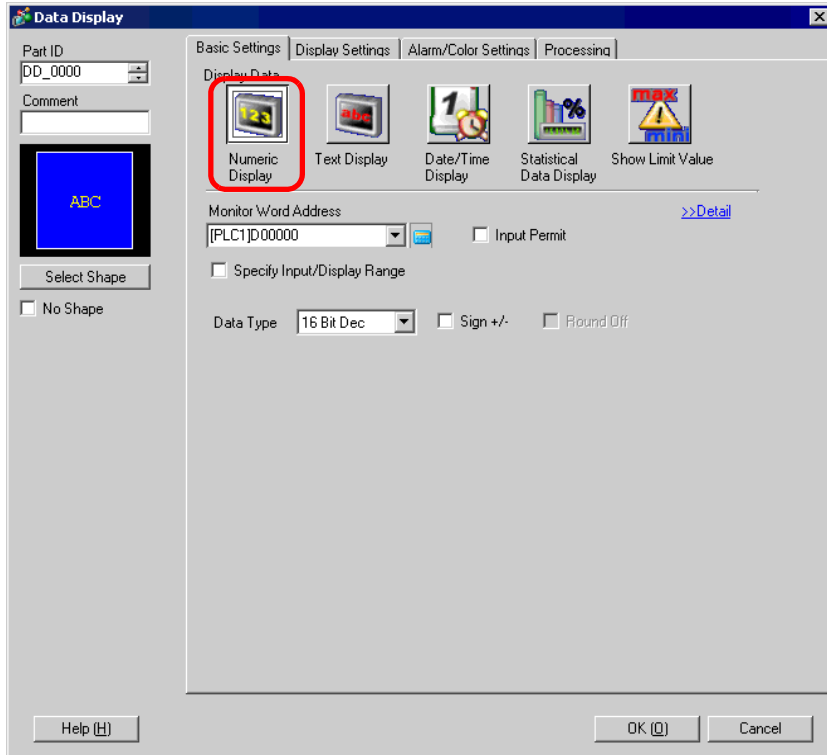

3 Select the Data Display shape from [Select Shape].

4 In [Monitor Word Address], set the address (D100) which will store the value to be displayed.

Click the icon to display an address input keypad.

Select device "D", input "100" as the address, and press the "Ent" key.

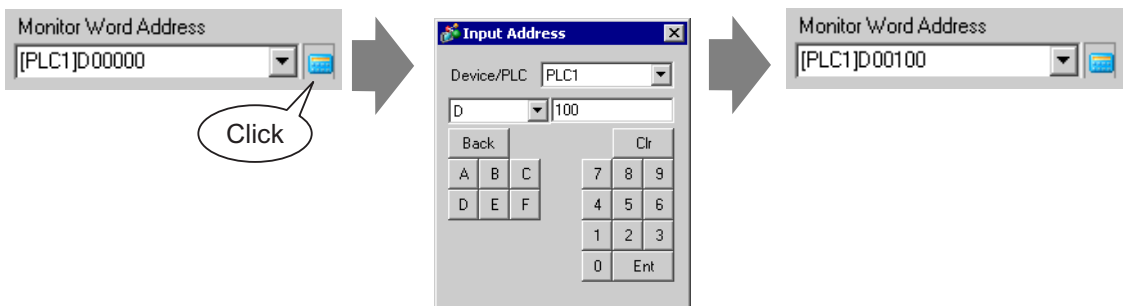

5 Set the type of data that will be displayed (e.g. “16 Bit Dec”) in [Data Type].

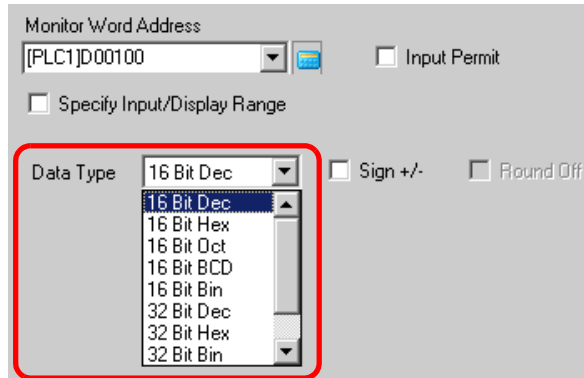

6 Click the [Alarm/Color Settings] tab, and put a check mark in the [Alarm Settings] box.

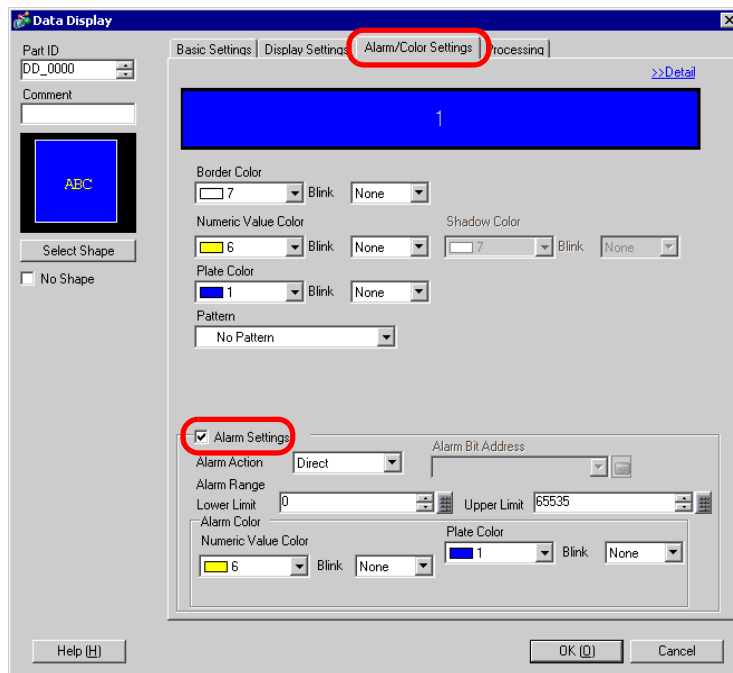

7 In [Alarm Action], select the Upper/Lower Limit Value’s specification method from [Direct] or [Address] (in this example, [Direct]).



8 In [Alarm Range], set the Upper Limit Value (e.g. 100) and Lower Limit Value (e.g. 0).

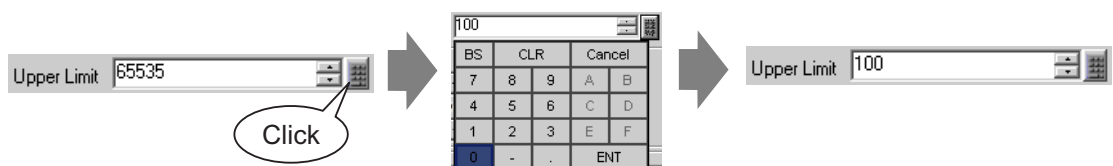

9 In [Alarm Color], set the [Numeric Value Color] (e.g. Red) and the [Plate Color] (e.g. Yellow).



10 As needed, set the Data Display's text on the [Display Settings] tab, and click [OK].

14.5 Color-coding and Displaying Multiple Ranges

14.5.1 Details

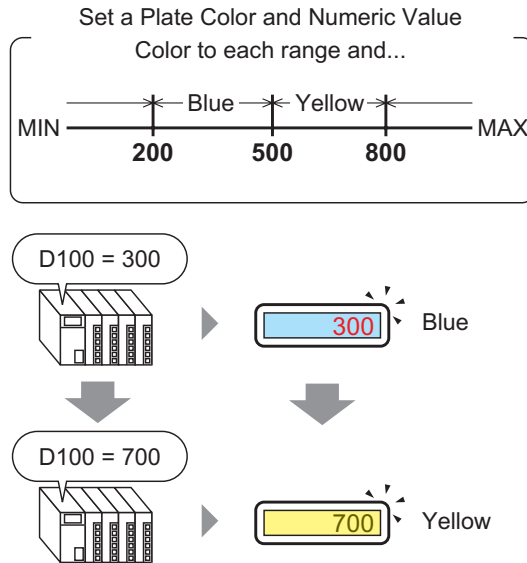



By setting colors for each range, values will change colors when they reach that set range. Plate/text color can be changed.

14.5.2 Setup Procedure

NOTE

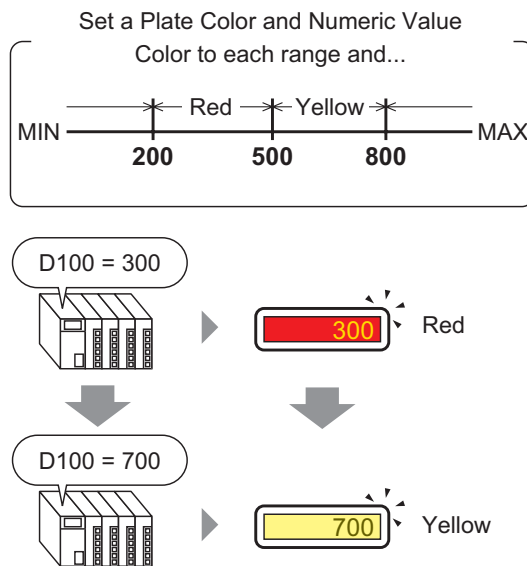
- Please refer to the Setup Guide for details.
 - ☞ “14.11.1 Numeric Display” (page 14-45)
- For details of the part placement method and the address, shape, color, and label setting method, refer to the “Part Editing Procedure”.
 - ☞ “9.6.1 Editing Parts” (page 9-37)



- 1 On the [Part (P)] menu, point to [Data Display (D)] and then click [Numeric Display (N)], or click the  icon, and place it on the screen.

2 Double-click the placed Data Display and the settings dialog box opens.

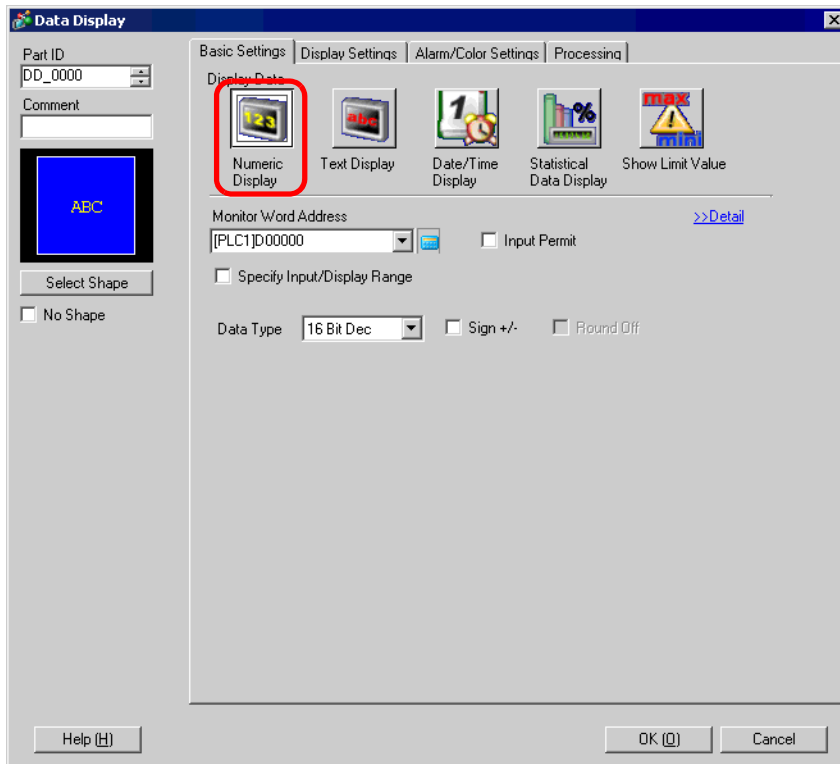

3 Select the Data Display shape from [Select Shape].

4 In [Monitor Word Address], set the address (D100) which will store the value to be displayed.

Click the icon to display an address input keypad.

Select device "D", input "100" as the address, and press the "Ent" key.

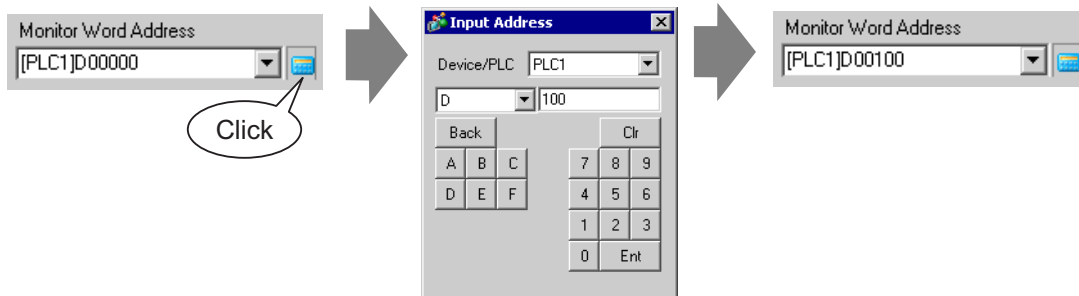

5 Set the type of data that will be displayed (e.g. “16 Bit Dec”) in [Data Type].

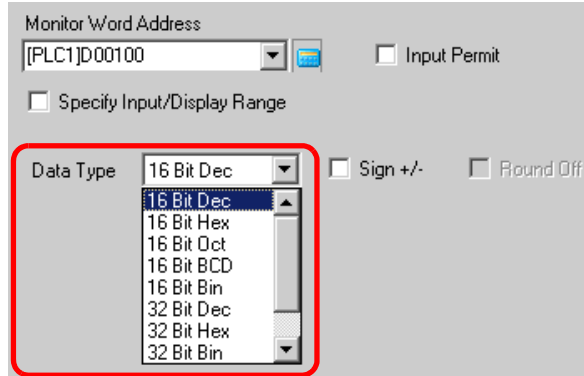

NOTE • Set [Specify Input/Display Range] and the numeric data can be converted comparatively and displayed.

6 Click the [Alarm/Color Settings] tab, and click [Detail].

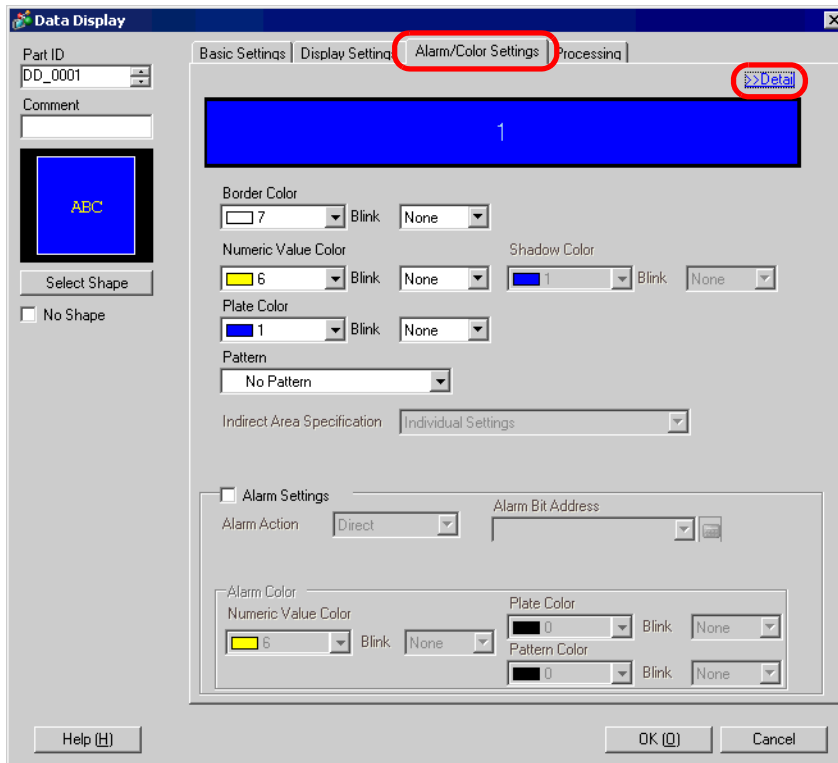

7 In [No. of Ranges], set the number of ranges (e.g. 4).

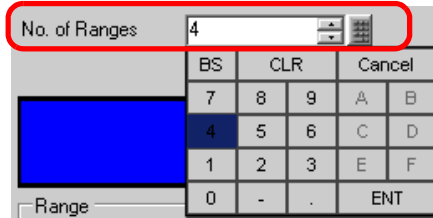

8 In [Specify Range], select the specification method Upper/Lower Limit Value's range from [Constant] or [Address] (in this example, [Constant]).



9 Select 1 from the [Alarm Color Display Bar], set [Range 01]'s Max Value and Min Value. (e.g. Min Value =0, Max Value =200)

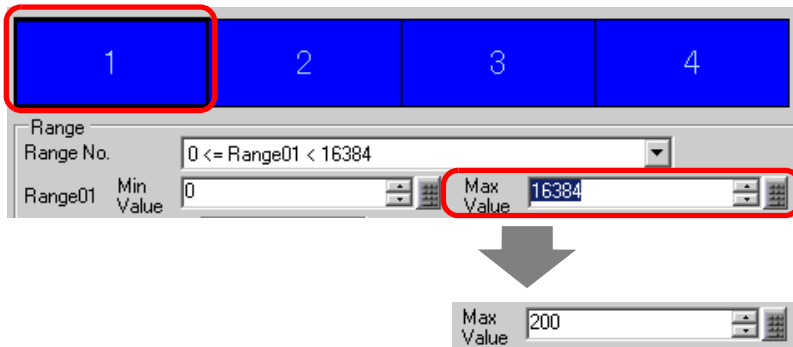

10 In [Alarm Color], set [Range 01]'s [Numeric Value Color] (e.g. Yellow) and the [Plate Color] (e.g. Blue).



11 Select 2 from the [Alarm Color Display Bar], set [Range 02]'s Max Value and Min Value. (e.g. Min Value = 200, Max Value = 500)

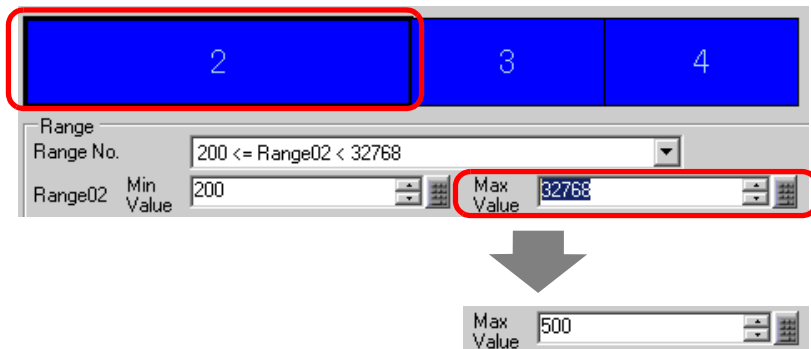

12 In [Alarm Color], set [Range 02]’s [Numeric Value Color] (e.g. Yellow) and the [Plate Color] (e.g. Red).



13 Select 3 from the [Alarm Color Display Bar], set [Range 03]’s Max Value and Min Value. (e.g. Min Value = 500, Max Value = 800)

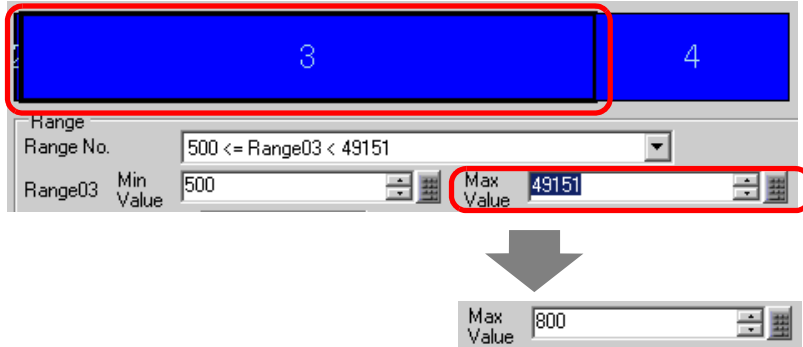

14 In [Alarm Color], set [Range 03]’s [Numeric Value Color] (e.g. Black) and the [Plate Color] (e.g. Yellow).



15 Select 4 from the [Alarm Color Display Bar], set [Range 04]’s Min Value. (e.g. Min Value = 800)

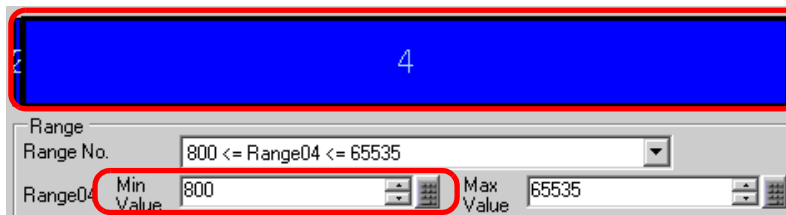

16 In [Alarm Color], set [Range 04]’s [Numeric Value Color] (e.g. Yellow) and the [Plate Color] (e.g. Blue).



17 As needed, set the Data Display’s text on the [Display Settings] tab, and click [OK].

14.6 Displaying the Date and Time

14.6.1 Details

2005/01/20 (Thu) 09:32

The GP's clock and calendar data are stored in a designated area of the System Data Area.

14.6.2 Setup Procedure

NOTE

- Please refer to the Setup Guide for details.
 - ☞ “14.11.3 Date/Time Display” (page 14-94)
- For details of the part placement method and the address, shape, color, and label setting method, refer to the “Part Editing Procedure”.
 - ☞ “9.6.1 Editing Parts” (page 9-37)

2005/01/20 (Thu) 09:32

- 1 On the [Part (P)] menu, point to [Data Display (D)] and then click [Text Display (S)], or click  , to place it on the screen.
- 2 Double-click the placed Data Display and the settings dialog box opens.

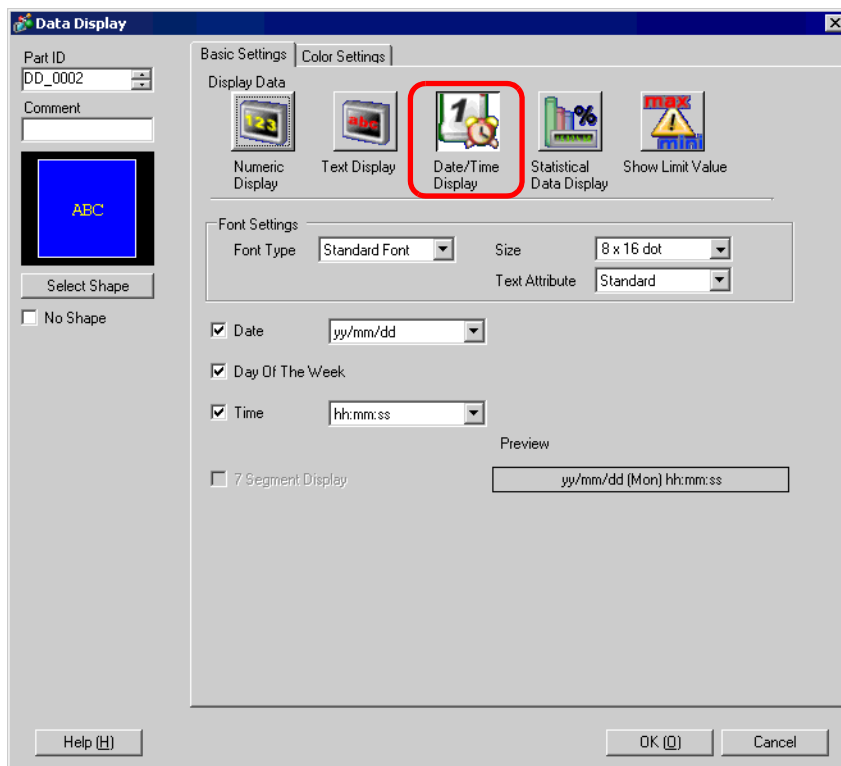

- 3 Select the Data Display shape from [Select Shape].

- 4 Choose a font for the date/time in [Font Settings]. (e.g. Standard Font, Size = 8 × 16 dots, Text Attribute = Standard)

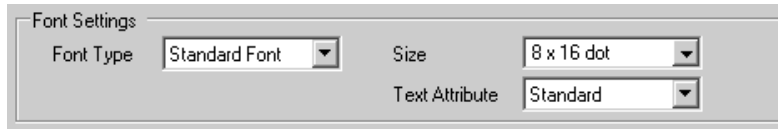

- 5 Select a date format in [Date]. (e.g. 20yy/mm/dd)

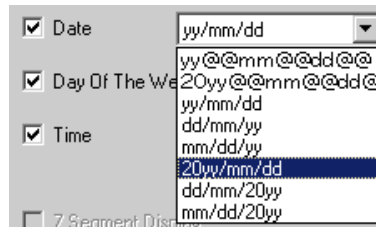

- 6 To display the day, put a check mark next to the [Day Of The Week] box. (e.g. Display day)

- 7 Select a time format in [Time]. (e.g. hh:mm)



- 8 As needed, set the Data Display's color on the [Color Settings] tab, and click [OK].

14.7 Preventing Operational Errors (Interlock)

14.7.1 Details

The touch action will only be executed if the bit address specified in the Interlock Address meets the Touch Enable Condition.

- When the Touch Enable Condition is “Bit ON”.
The touch action will only work when the set Interlock Address is ON.

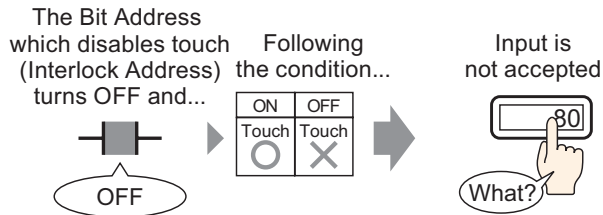

- When the Touch Enable Condition is “Bit OFF”.
The touch action will only work when the set Interlock Address is OFF.

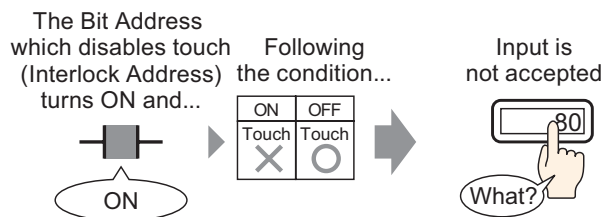

14.7.2 Setup Procedure

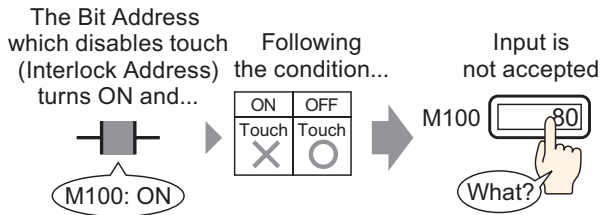

NOTE

- Please refer to the Setup Guide for details.
 - ☞ “14.11.1 Numeric Display” (page 14-45)
- For details of the part placement method and the address, shape, color, and label setting method, refer to the “Part Editing Procedure”.
 - ☞ “9.6.1 Editing Parts” (page 9-37)

- 1 On the [Part (P)] menu, point to [Data Display (D)] and then click [Numeric Display (N)], or click the  icon, and place it on the screen.
- 2 Double-click the placed Data Display and the settings dialog box opens.

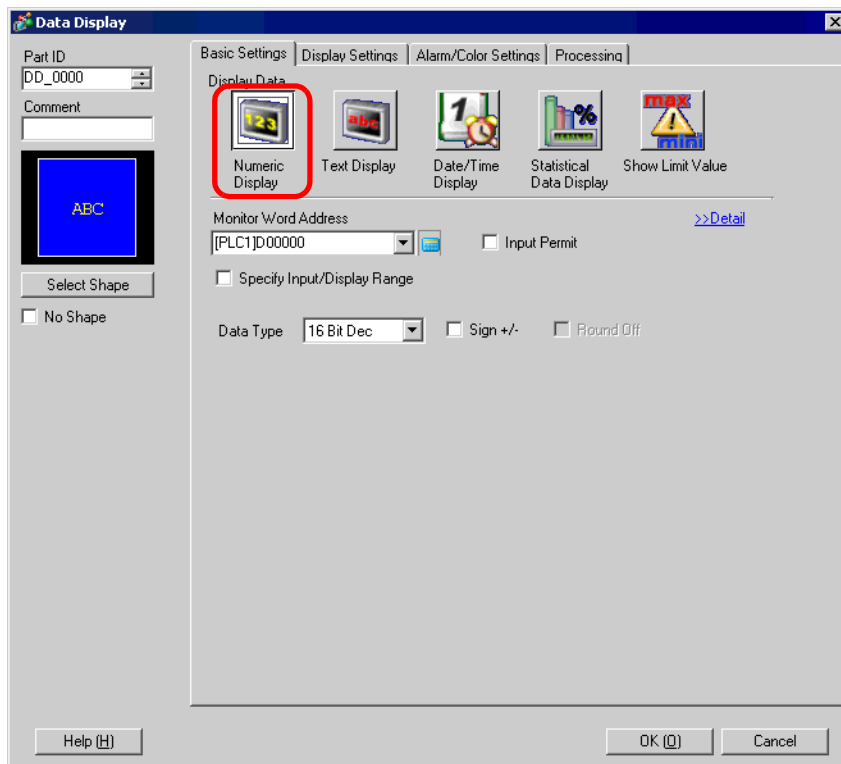

- 3 Select the Data Display shape from [Select Shape].

4 In [Monitor Word Address], set the address (D100) which will store the value to be displayed.

Click the icon to display an address input keypad.

Select device "D", input "100" as the address, and press the "Ent" key.

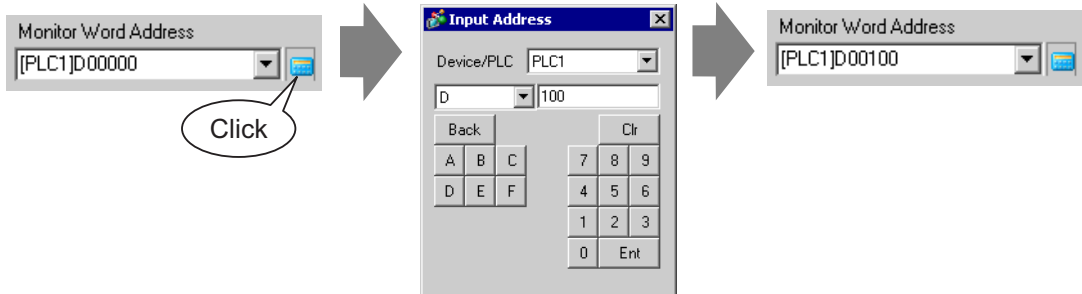

5 Set the type of data that will be displayed (e.g. "16 Bit Dec") in [Data Type].

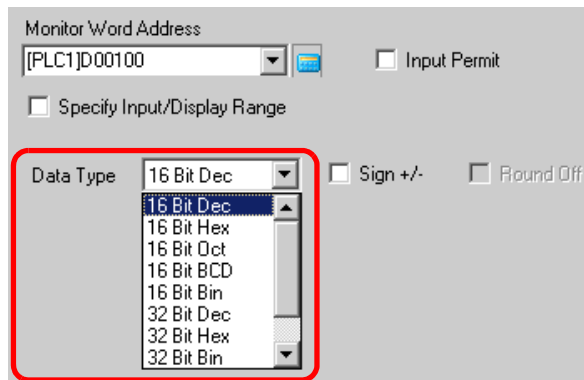

6 Put a check mark next to [Input Permit]. Check [Input Permit] to display the [Input Permit] tab. Check that [Enable Popup Keypad] is checked. You can enter numerical data from the popup keypad.

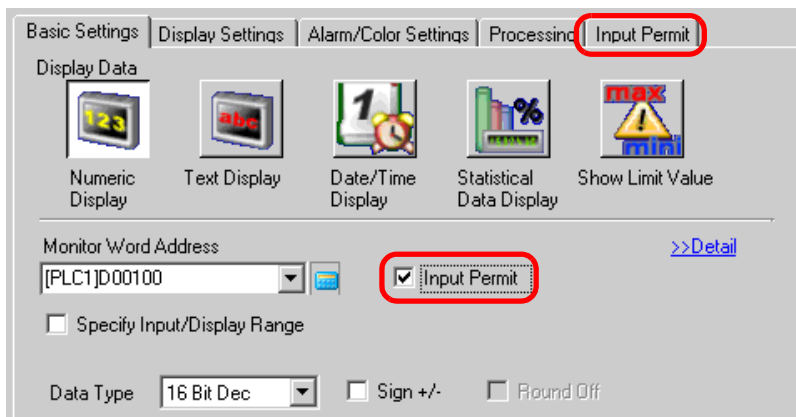

7 Click the [Input Permit] tab, click [Detail] and the following dialog box is displayed.

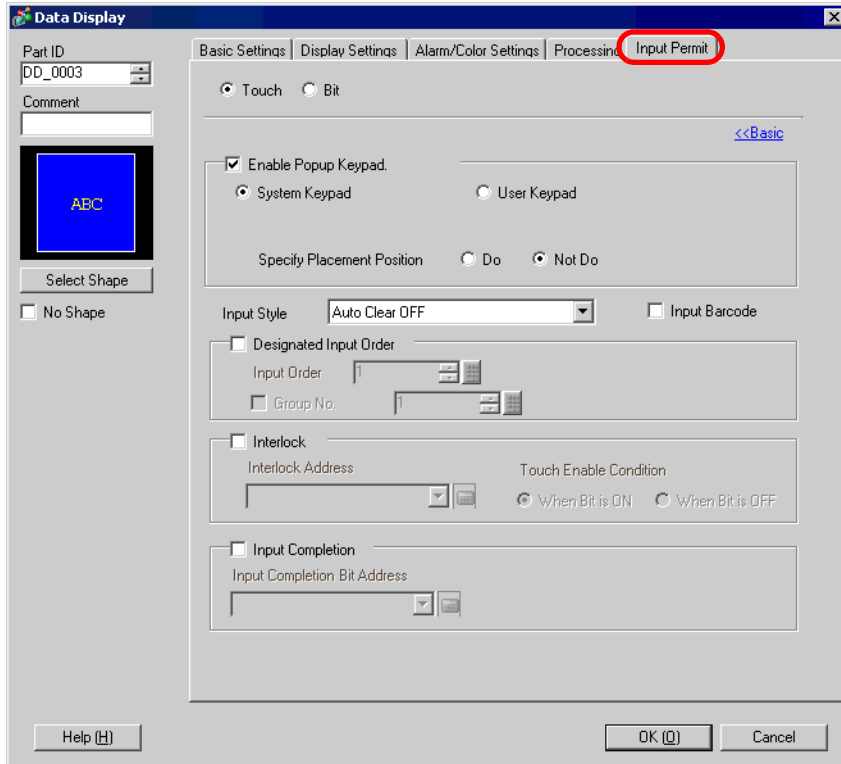

8 Select the [Interlock] check box, then in the [Interlock Address] field specify the bit address (M100) that will enable touch operations.

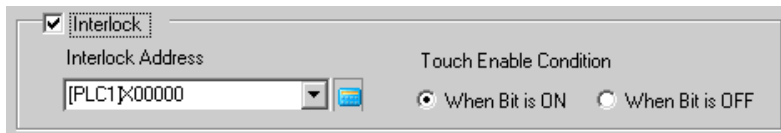

9 In the [Touch Enable Condition] field specify the condition that will enable touch operations (e.g.: "When Bit is OFF" for the touch operations are enable when bit OFF).

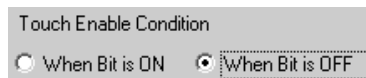

10 As needed, set the Data Display's color and text on the [Alarm/Color Settings] tab and [Display Settings] tab, and click [OK].

14.8 Prevent Entering Data Outside the Allowed Range

14.8.1 Details

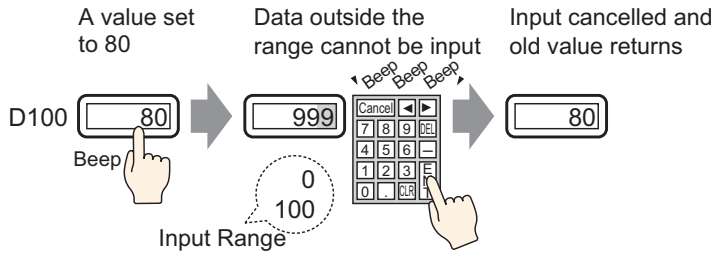

14.8.2 Setup Procedure

NOTE

- Please refer to the Setup Guide for details.
 - ☞ “14.11.1 Numeric Display” (page 14-45)
- For details of the part placement method and the address, shape, color, and label setting method, refer to the “Part Editing Procedure”.
 - ☞ “9.6.1 Editing Parts” (page 9-37)

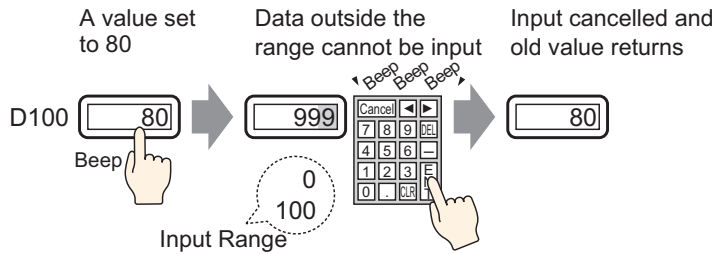

- 1 On the [Part (P)] menu, point to [Data Display (D)] and then click [Numeric Display (N)], or click the  icon, and place it on the screen.
- 2 Double-click the placed Data Display and the settings dialog box opens.

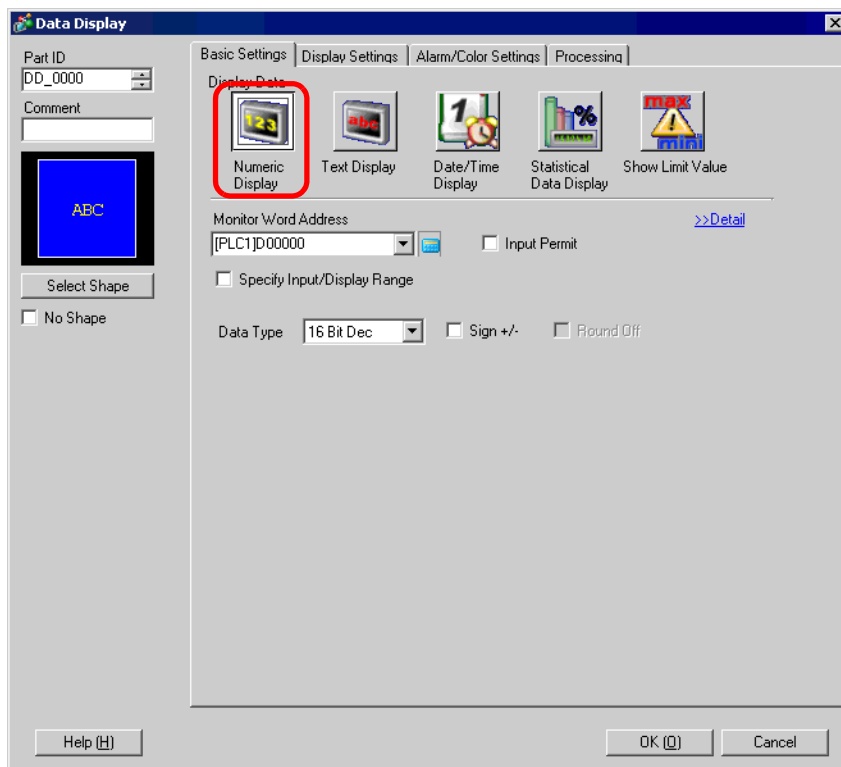

- 3 Select the Data Display shape from [Select Shape].

4 In [Monitor Word Address], set the address (D100) which will store the value to be displayed.

Click the icon to display an address input keypad.

Select device "D", input "100" as the address, and press the "Ent" key.

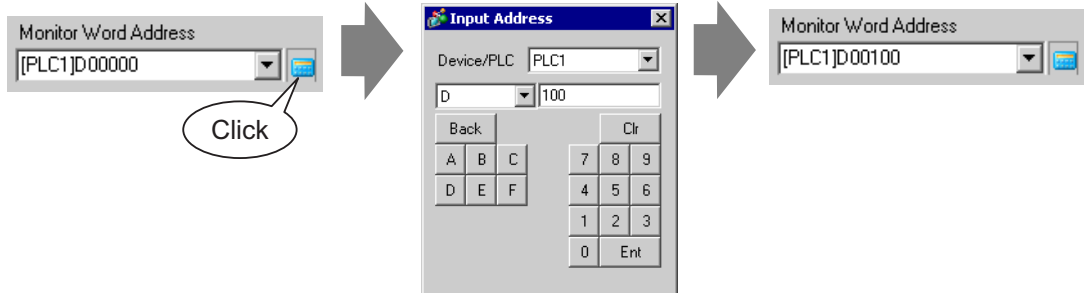

5 Set the type of data that will be displayed (e.g. "16 Bit Dec") in [Data Type].

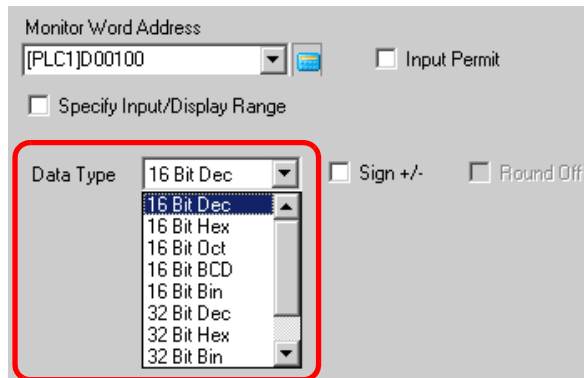

6 Put a check mark next to [Input Permit]. Check [Input Permit] to display the [Input Permit] tab. Check that [Enable Popup Keypad] is checked. You can enter numerical data from the popup keypad.

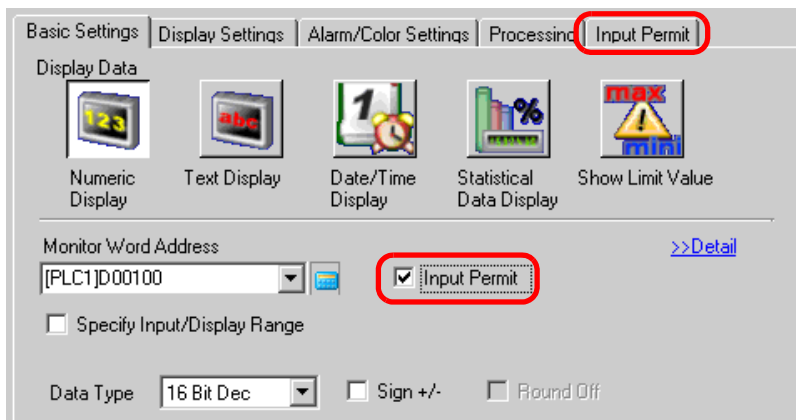

7 Click the [Alarm/Color Settings] tab, and put a check mark in the [Alarm Settings] box.

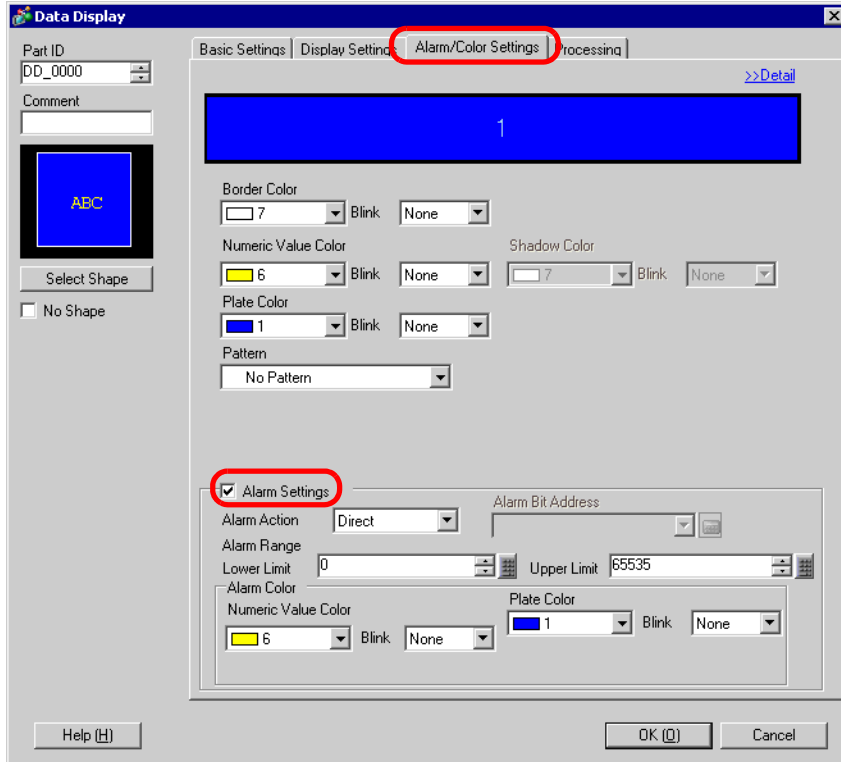

8 In [Alarm Action], select the Upper/Lower Limit Value's specification method from [Direct] or [Address] (in this example, [Direct]).



9 In [Alarm Range], set the Upper Limit Value (e.g. 100) and Lower Limit Value (e.g. 0).

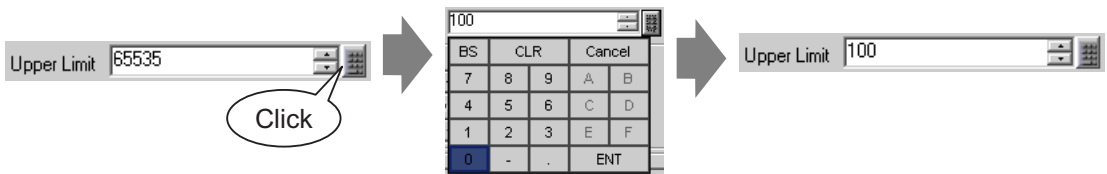

NOTE • Values entered from the PLC are not subject to alarm operations.

10 As needed, set the Data Display's color and text on the [Alarm/Color Settings] tab and [Display Settings] tab, and click [OK].

14.9 Sequential Input

14.9.1 Details

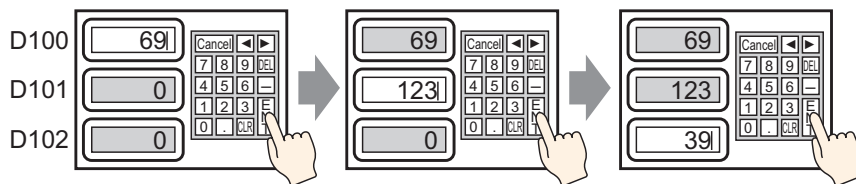

Input data and touch the [Ent] key

The input is confirmed and the next Data Display part in the input order enters the Input Permit state. → Input data and touch the [Ent] key

14.9.2 Setup Procedure

- NOTE**
- Please refer to the Setup Guide for details.
 - ☞ “14.11.1 Numeric Display” (page 14-45)
 - For details of the part placement method and the address, shape, color, and label setting method, refer to the “Part Editing Procedure”.
 - ☞ “9.6.1 Editing Parts” (page 9-37)

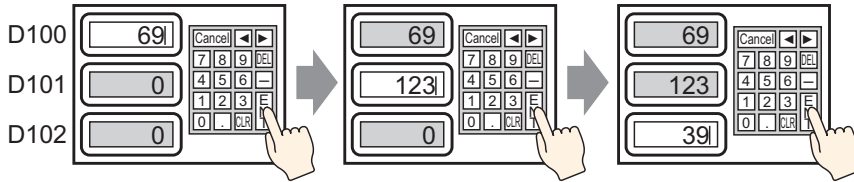

Input data and touch the [Ent] key.

The input is confirmed and the next Data Display part in the input order enters the Input Permit state. → Input data and touch the [Ent] key.

- 1 On the [Part (P)] menu, point to [Data Display (D)] and then click [Numeric Display (N)], or click the  icon, and place it on the screen.
- 2 Double-click the placed Data Display and the settings dialog box opens.

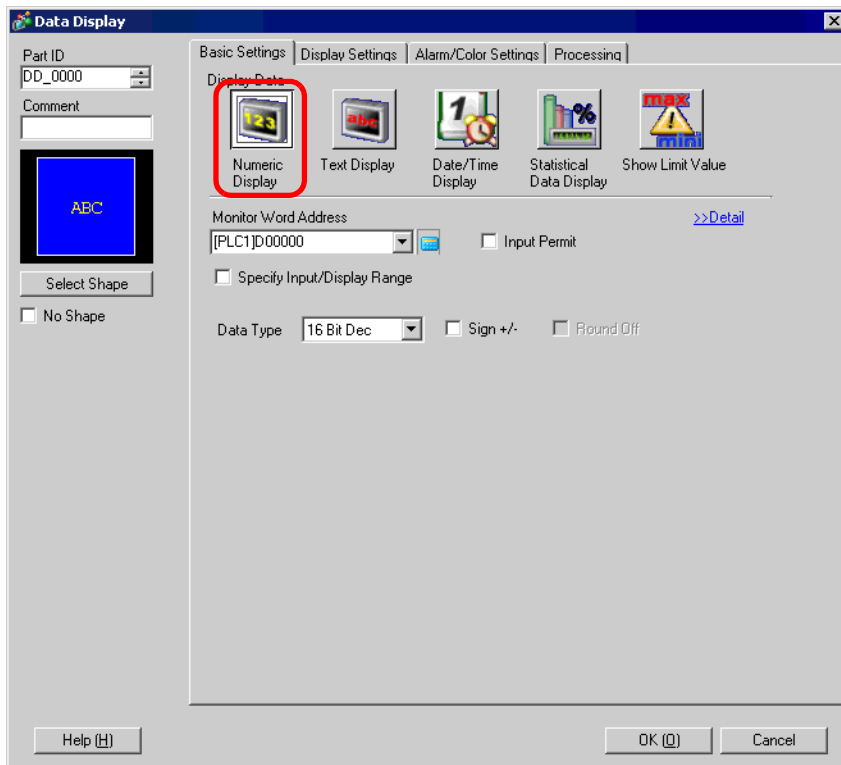

- 3 Select the Data Display shape from [Select Shape].

4 In [Monitor Word Address], set the address (D100) which will store the value to be displayed.

Click the icon to display an address input keypad.

Select device "D", input "100" as the address, and press the "Ent" key.

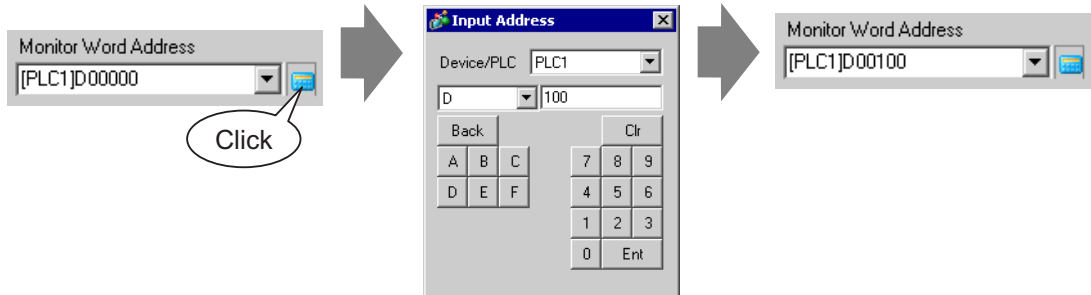

5 Set the type of data that will be displayed (e.g. "16 Bit Dec") in [Data Type].

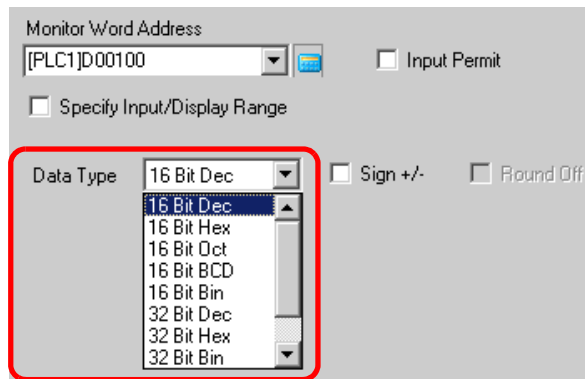

6 Put a check mark next to [Input Permit]. Check [Input Permit] to display the [Input Permit] tab. Check that [Enable Popup Keypad] is checked. You can enter numerical data from the popup keypad.

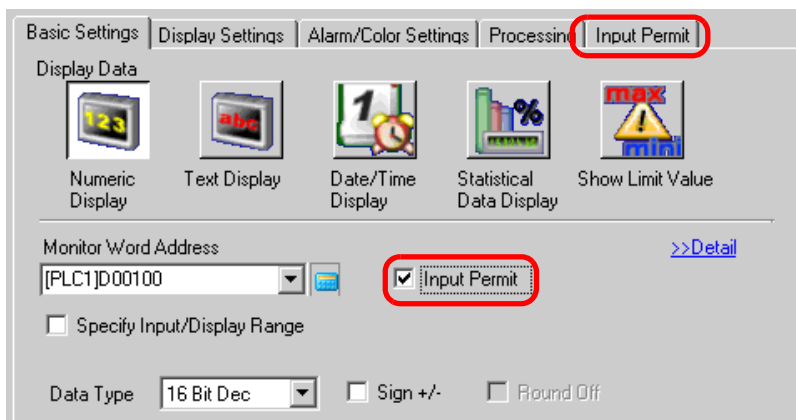

7 Click the [Input Permit] tab, and put a check mark in the [Designated Input Order] box.

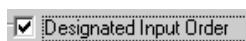

8 In [Input Order], set the order the part will enter input status (e.g. 1).

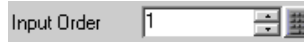

9 As needed, set the Data Display's color and text on the [Alarm/Color Settings] tab and [Display Settings] tab, and click [OK].

NOTE

- In the same way, to set the 2nd Data Display that will enter the Input Permit state, set [Monitor Word Address] to "D101", and [Input Order] to "2". For the 3rd Data Display that will enter the Input Permit state, set [Monitor Word Address] to "D102", and [Input Order] to "3".
 - For information about the Input Order settings, refer to "14.13.1 Set Input Order" (page 14-106).
-

14.10 Changing Values by Adding/Subtracting

14.10.1 Details



When you use a word switch's Add/Subtract Data function, the directly referenced data in a Data Display can be modified. This is useful for fine-tuning and small-scale adjustments. This setup is an option for increasing or decreasing values. When the value rolls over, it carries over changes to other digits.

14.10.2 Setup Procedure

NOTE

- Please refer to the Setup Guide for details.
 - ☞ “14.11.1 Numeric Display” (page 14-45)
- For details of the part placement method and the address, shape, color, and label setting method, refer to the “Part Editing Procedure”.
 - ☞ “9.6.1 Editing Parts” (page 9-37)



- 1 On the [Part (P)] menu, point to [Data Display (D)] and then click [Numeric Display (N)], or click the  icon, and place it on the screen.
- 2 Double-click the placed Data Display and the settings dialog box opens.

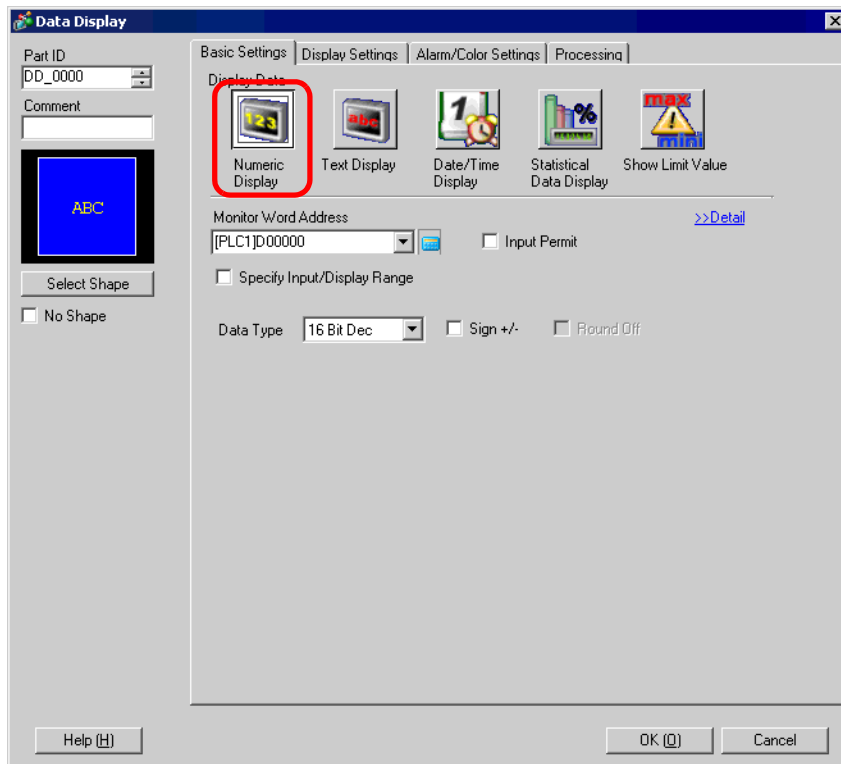

- 3 Select the Data Display shape from [Select Shape].

4 In [Monitor Word Address], set the address (D100) which will store the value to be displayed.

Click the icon to display an address input keypad.

Select device "D", input "100" as the address, and press the "Ent" key.

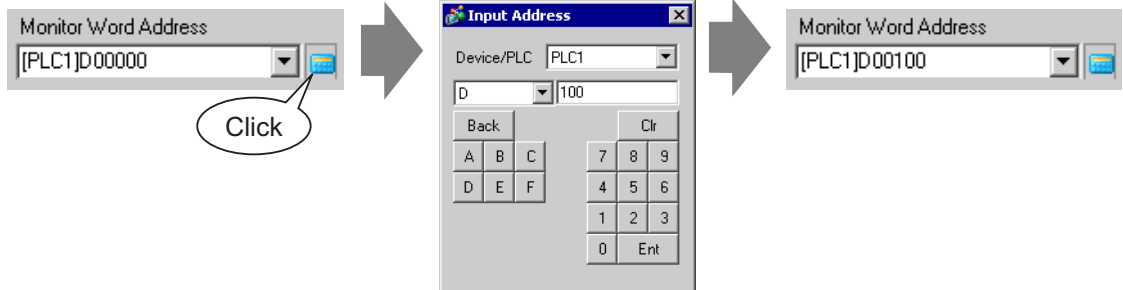

5 Set the type of data that will be displayed (e.g. "16 Bit Bin") in [Data Type].

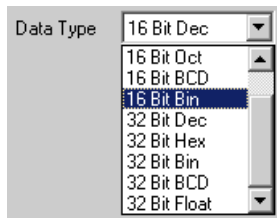

6 As needed, set the Data Display's color and text on the [Alarm/Color Settings] tab and [Display Settings] tab, and click [OK].

7 Next, set the switch which will operate the addition action. Select the [Part (P)] menu - [Switch Lamp] option - [Word Switch] command, or click , and place it on the screen.

8 Double-click the placed Switchpart and the settings dialog box opens.

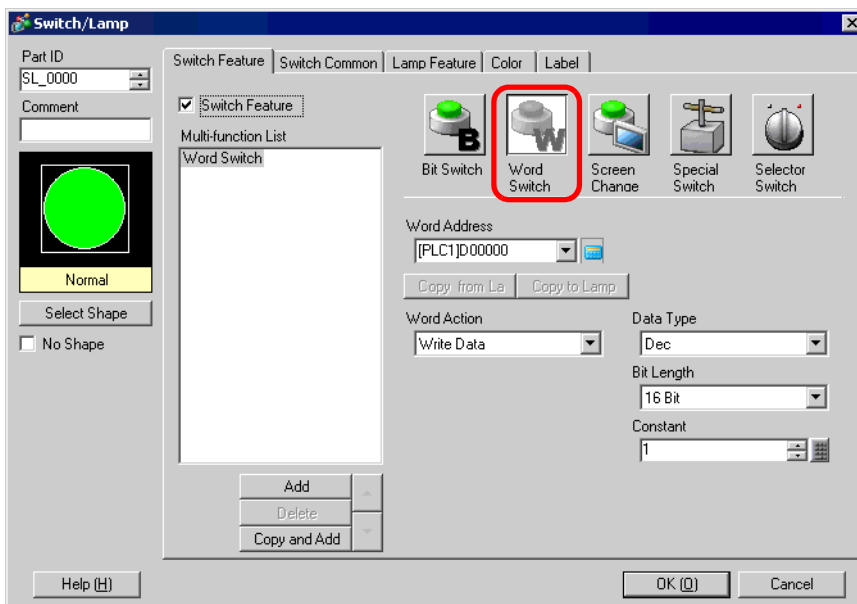

9 Select the Switch's shape from [Select Shape].

- Set the address (D100) where you want to write data when you touch the switch in [Word Address].

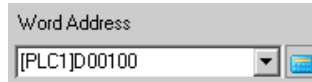

- Choose [Add Data] from [Word Action].

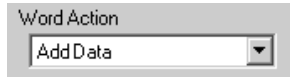

- Set the address (D100) which will add the data in [Addition Base Word Address].

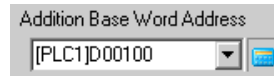

- Set [Data Type] to [Bin] and [Constant] to "1" and click [OK]. The addition action's word switch function is now set.

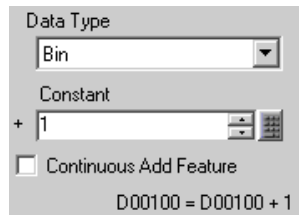

- Next, set the switch which will operate the subtraction action. Select the [Part (P)] menu - [Switch Lamp] option - [Word Switch] command, or click  and place it on the screen.

- Double-click the placed Switchpart and the settings dialog box opens.

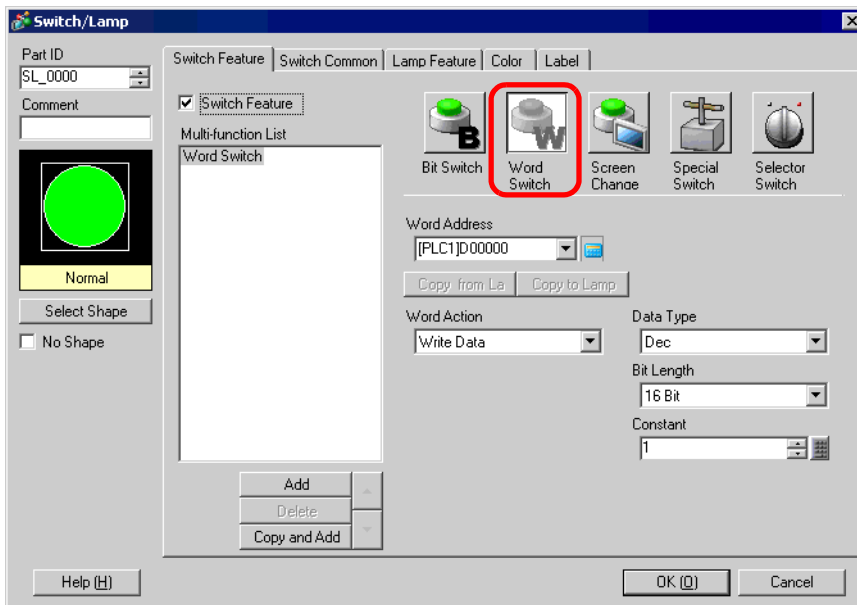

- Select the Switch's shape from [Select Shape].

- 17 Set the address (D100) where you want to write data when you touch the switch in [Word Address].

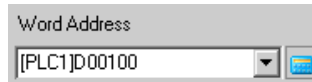

The screenshot shows a dialog box titled "Word Address". It contains a text input field with the value "[PLC1]D00100" and a dropdown arrow to its right. To the right of the dropdown is a small icon with a blue background and a white symbol.

- 18 Choose [Subtract Data] from [Word Action].

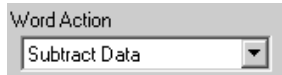

The screenshot shows a dialog box titled "Word Action". It contains a dropdown menu with the text "Subtract Data" selected.

- 19 Set the address (D100) which will subtract the data in [Subtraction Base Word Address].

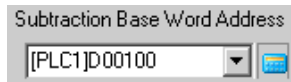

The screenshot shows a dialog box titled "Subtraction Base Word Address". It contains a text input field with the value "[PLC1]D00100" and a dropdown arrow to its right. To the right of the dropdown is a small icon with a blue background and a white symbol.

- 20 Set [Data Type] to [Bin] and [Constant] to "1" and click [OK]. The subtraction action's word switch function is now set.

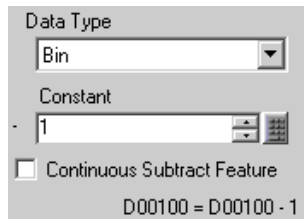

The screenshot shows a dialog box titled "Data Type". It contains a dropdown menu with "Bin" selected. Below it is a "Constant" field with the value "1" and a small calculator icon to its right. There is an unchecked checkbox labeled "Continuous Subtract Feature". At the bottom, the text "D00100 = D00100 - 1" is displayed.

14.11 Data Display Settings Guide

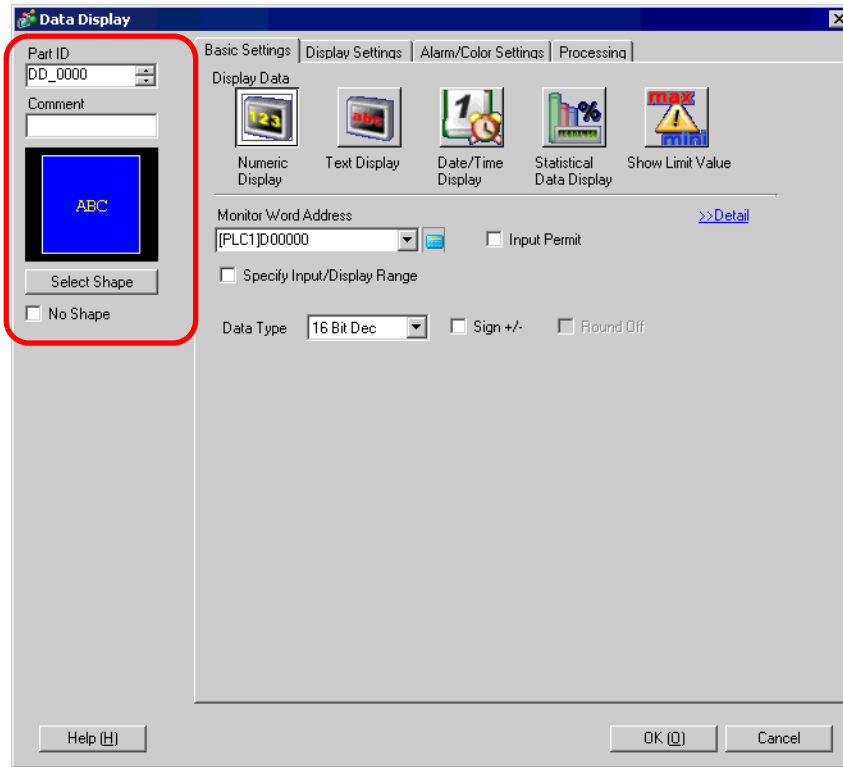

Setting	Description
Part ID	Placed parts are automatically assigned an ID number. Data Display's ID: DD_ ****(4 digits) The letter portion is fixed. The number portion can be modified from 0000 to 9999.
Comment	The comment for each Part can be up to 20 characters long.
Shape Display	Displays the shape and status of the Part selected in [Select Shape].

Continued

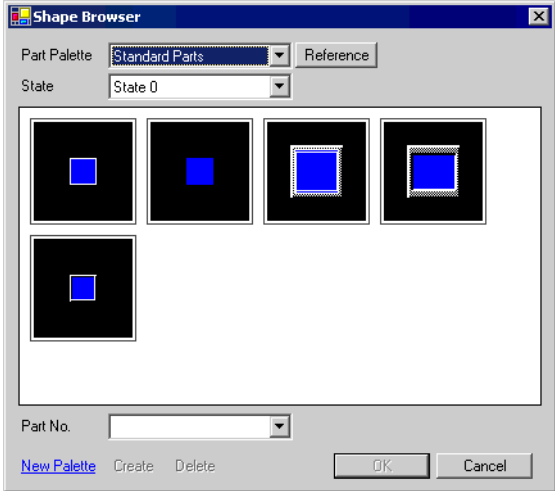
Setting	Description
Select Shape	<p>Open the Select Shape dialog box to choose the Part's shape.</p> 
Display Data	<p>Select the Data Display's type.</p> <ul style="list-style-type: none"> • Numeric Display Displays the numeric data stored in the word address. ☞ "14.11.1 Numeric Display" (page 14-45) • Text Display Displays the character string stored in the word address. ☞ "14.11.2 Text Display" (page 14-78) • Date/Time Display Refers to the GP's clock data and displays the date/time. ☞ "14.11.3 Date/Time Display" (page 14-94) • Statistical Data Display Takes statistics from the successive values of multiple word addresses, and displays the numeric value. ☞ "14.11.4 Statistical Data Display" (page 14-97) • Show Limit Value Displays the set Alarm values (the displayed data's upper/lower limit values) on the same screen as a Numeric Display with [Alarm Settings]. ☞ "14.11.5 Show Limit Value" (page 14-101)
No Shape	Select whether or not the part will be transparent with no shape.

14.11.1 Numeric Display

■ Basic Settings/Basic

Display numeric data stored in a specified word address in a device/PLC.

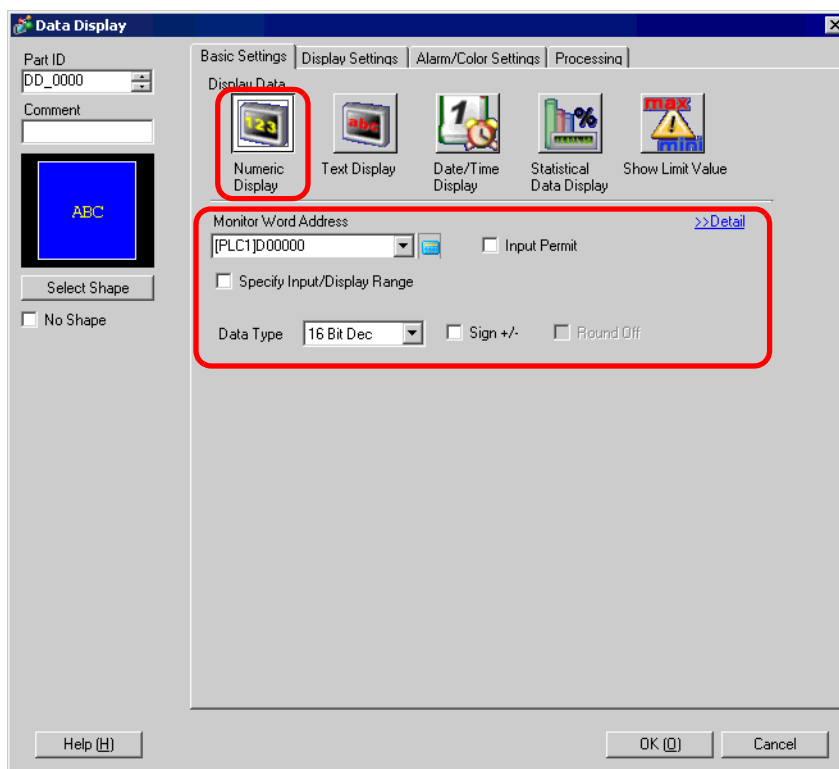

Setting	Description
Monitor Word Address	<p>The data stored in this word address will be displayed in real-time as a numeric value.</p> <p>NOTE</p> <ul style="list-style-type: none"> Real variables cannot be displayed because they have 64-bit length.
Input Permit	<p>Set whether keypad and barcode reader input will be accepted by the Data Display.</p> <p>NOTE</p> <ul style="list-style-type: none"> This can not be set if the [Display Format] option is set on the [Display Settings] tab's [Detail] screen. <p>☞ " ■ Input Permit/Basic" (page 14-56)</p>
Specify Input/ Display Range	<p>Specify an input/display range and [Monitor Word Address] data will automatically convert to correspond with the input and display range. The resulting numeric values can be displayed.</p>

Continued

Setting	Description						
Data Type	<p>Select the type of data to be displayed.</p> <table border="1"> <thead> <tr> <th>Bit Length</th> <th>Data Type</th> </tr> </thead> <tbody> <tr> <td>16 Bit</td> <td>Dec, Hex, Oct, Bin, BCD</td> </tr> <tr> <td>32 bit</td> <td>Dec, Hex, Bin, BCD, Float</td> </tr> </tbody> </table> <p>NOTE</p> <ul style="list-style-type: none"> When using 32-bit data, the relationship of high order and low order word data will differ according to the device/PLC type. ↗ “Device/PLC Connection Manual” 	Bit Length	Data Type	16 Bit	Dec, Hex, Oct, Bin, BCD	32 bit	Dec, Hex, Bin, BCD, Float
Bit Length	Data Type						
16 Bit	Dec, Hex, Oct, Bin, BCD						
32 bit	Dec, Hex, Bin, BCD, Float						
Sign +/-	<p>Select whether or not to attach a sign to displayed data. Select this if you will be using negative data. Negative numbers are handled with 2’s complement. This can only be set when the [Data Type] is [Dec].</p>						
Round Off	<p>Select whether or not fractions will be rounded off when data is displayed. Fractions will be discarded if rounding off is not selected. This can only be set when the [Data Type] is [Float].</p>						

Set numeric data to be displayed as relative values.

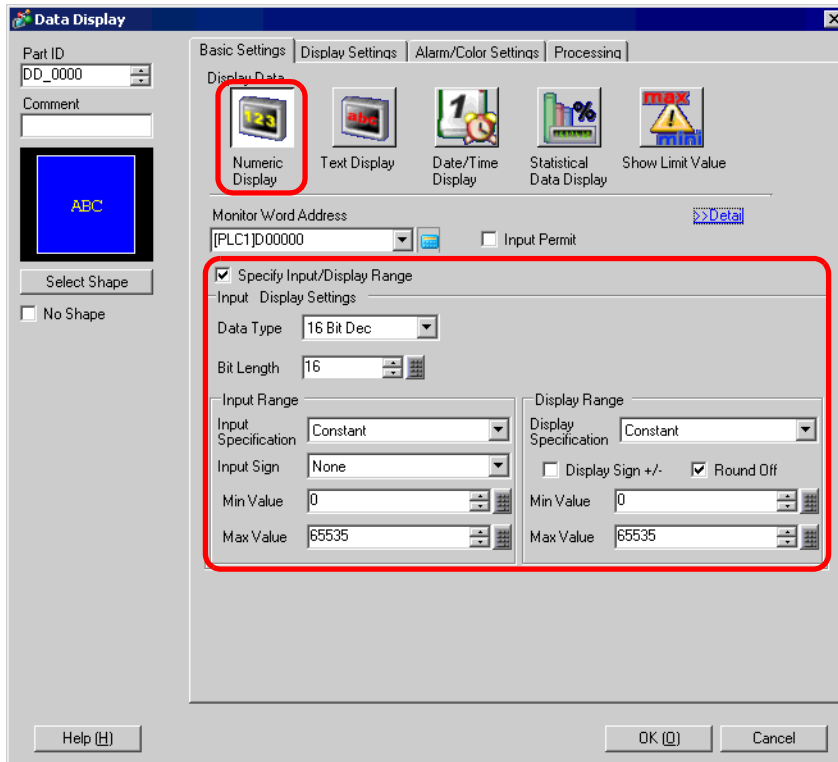

Setting		Description						
Specify Input/Display Range		<p>Specify an input/display range and [Monitor Word Address] data will automatically convert to correspond with the input and display range. The resulting numeric values can be displayed. (Display relative values) e.g.)</p>						
Data Type		<p>Select the type of data to be displayed.</p> <table border="1"> <thead> <tr> <th>Bit Length</th> <th>Data Type</th> </tr> </thead> <tbody> <tr> <td>16 Bit</td> <td>Dec, Hex, Oct, Bin, BCD</td> </tr> <tr> <td>32 bit</td> <td>Dec, Hex, Bin, BCD, Float</td> </tr> </tbody> </table>	Bit Length	Data Type	16 Bit	Dec, Hex, Oct, Bin, BCD	32 bit	Dec, Hex, Bin, BCD, Float
Bit Length	Data Type							
16 Bit	Dec, Hex, Oct, Bin, BCD							
32 bit	Dec, Hex, Bin, BCD, Float							
Input Range	Input Specification	<p>Choose how the input range's max and min values will be specified.</p> <ul style="list-style-type: none"> • Constant Designate a set constant as the Min/Max value. (Direct Specification) • Address Designate the address where the Min/Max Values are stored. (Indirect Specification) 						
	Input Sign	<p>Specifies whether inputted data will be able to handle negative numeric data.</p> <ul style="list-style-type: none"> • None Only positive numeric data. • 2's Complement Negative numbers are handled with 2's complement. • MSB Sign Negative numbers are handled with MSB sign. 						
Display Range	Display Specification	<p>Choose how the display range's max and min value will be specified.</p> <ul style="list-style-type: none"> • Constant Designate a set constant as the Min/Max value. (Direct Specification) • Address Designate the address where the Min/Max Values are stored. (Indirect Specification) 						
	Round Off	Select whether or not fractions get rounded off when data is displayed.						
	Display Sign +/-	<p>Specify whether or not negative numbers will be displayed. This can be set when the [Data Type] is [Dec]. e.g.) When the data "-123" has been written</p> <div style="display: flex; justify-content: space-around; align-items: center;"> <div style="text-align: center;"> <input checked="" type="checkbox"/> Display Sign +/- Negative numbers displayed </div> <div style="text-align: center;"> <input type="checkbox"/> Display Sign +/- Negative numbers not displayed </div> </div>						

Continued

Setting		Description					
Input Range/ Display Range	Min. Value/ Max. Value	Select the input range and display range for the numeric display data. If [Input Specification] or [Display Specification] is [Constant], you can input a min/max value. If [Address] is set, specify the word address where the min/max value will be stored. Each [Data Type], [Input Sign], and [Display Sign +/-] has a different size range.					
		Bit Length	Data Type	Input Sign	Input Range	Display Sign +/-	Display Range
		16 Bit	Dec	None	0 to 65535	Unchecked	0 to 65535
				2's Complement	-32,768 to 32,767	Checked	-32,768 to 32,767
						Unchecked	0 to 65535
				MSB Sign	- 32767 to 73276	Checked	-32,768 to 32,767
						Unchecked	0 to 65535
				Hex	None	0 to 65535	-
			2's Complement		-32,768 to 32,767	-	0 to FFFF(h)
			MSB Sign		-32767 to 32767	-	0 to FFFF(h)
			Oct	None	0 to 65535	-	0 to 177777(o)
				2's Complement	-32,768 to 32,767	-	0 to 177777(o)
				MSB Sign	-32767 to 32767	-	0 to 177777(o)
			BCD	-	0 to 9999	-	0 to 9999
		Bin	None	0 to 65535	-	0 to FFFF(h)	
			2's Complement	-32,768 to 32,767	-	0 to FFFF(h)	
			MSB Sign	-32767 to 32767	-	0 to FFFF(h)	
		32 bit	Dec	None	0 to 4294967295	Unchecked	0 to 4294967295
						Checked	-2147483648 to 2147483647
				2's Complement	-2147483648 to 2147483647	Unchecked	0 to 4294967295
						Checked	-2147483648 to 2147483647
				MSB Sign	-2147483647 to 2147483647	Unchecked	0 to 4294967295
						Checked	-2147483648 to 2147483647
			Hex	None	0 to 4294967295	-	0 to FFFFFFFF(h)
				2's Complement	-2147483648 to 2147483647	-	0 to FFFFFFFF(h)
				MSB Sign	-2147483647 to 2147483647	-	0 to FFFFFFFF(h)
			BCD	-	0 to 99999999	-	0 to 99999999
			Bin	None	0 to 4294967295	-	0 to FFFFFFFF(h)
2's Complement	-2147483648 to 2147483647			-	0 to FFFFFFFF(h)		
MSB Sign	-2147483647 to 2147483647	-		0 to FFFFFFFF(h)			
Float	-	- 9.9e ¹⁶ to 9.9e ¹⁶	-	- 9.9e ¹⁶ to 9.9e ¹⁶			

NOTE • The Input Range and Display Range are used to decide how the values will be automatically converted and displayed. If a value outside of the Input Range is entered and converted, it will also appear outside of the Display Range.

■ Basic Settings/Detail

You can indirectly specify the address for the numeric data display. There are two ways to do this.

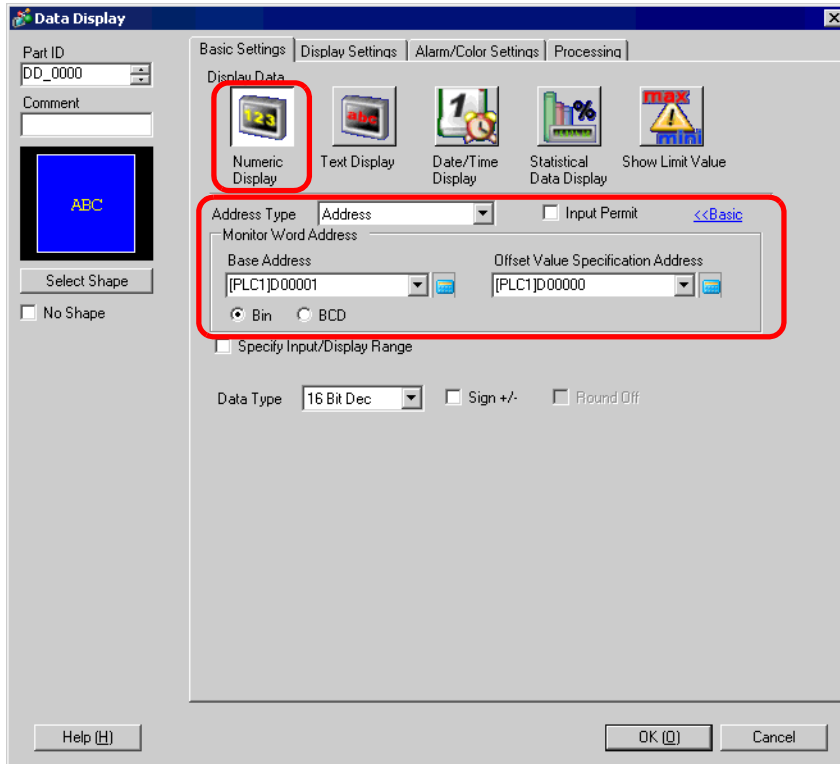

Setting	Description
Address Type	You can define the display address (Monitor Word Address) in the following ways: [Direct Specification], [Address], or [Device Type & Address].
Input Permit	You can accept inputs from a keypad, bar code reader, or a two-dimensional bar code reader. Select this check box to display the [Input Permit] tab. NOTE <ul style="list-style-type: none"> This can not be set if the [Display Format] option is set on the [Display Settings] tab's [Detail] screen. ☞ " ■ Display Settings/Detail" (page 14-66)
Monitor Word Address	You can have a real-time numeric display of data stored in the word address specified here. To indirectly specify the Monitor Word Address, in the [Address Type] list, select [Address] or [Device Type & Address].
Address	Indirectly designates to the device specified in [Base Address].

Continued

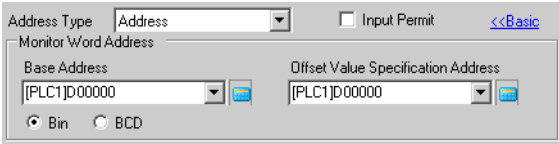
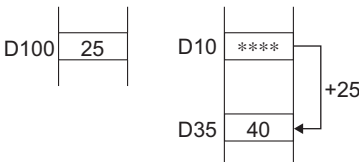
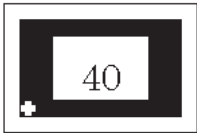
Setting		Description
Monitor Word Address	Address	 <p>The [Base Address] becomes the standard indirectly designated address. In [Offset Value Specification Address], set the address that stores the offset value from the [Base Address]. e.g.) [Monitor Word Address] is D35, Indirectly designated [Base Address] = D10 [Offset Value Specification Address] = D100 The data in [Offset Value Specification Address] is handled as the offset value from the [Base Address].</p>
		<p>In the device/PLC</p>  <p>GP unit</p>  <p>The [Base Address] (D10) is added to the [Offset Value Specification Address] (D100)'s data, which is "25", and the resulting address D35's data "40" is displayed.</p>
	Bin, BCD	<p>IMPORTANT</p> <ul style="list-style-type: none"> If the [Base Address] + [Offset Value] operation results in overflowing digits (more than 16-bit), the correct Monitor Word Address cannot be requested. In this case the Monitor Word Address will be undefined.
	Device Type & Address	Indirectly designates both the device and address.
	Device/PLC	When [Address Type] is [Device Type & Address], select which device/PLC's address to indirectly designate.

Continued

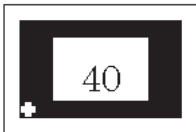
Setting			Description												
Monitor Word Address	Device Type & Address	Device Specification Start Address	<div style="text-align: center;">  </div> <p>Input the start address of the word address in order for the [Device Specification Start Address] to designate the display address. The [Device Specification Start Address] stores the address mode. The Address Mode is the mode which decides whether the device address is the internal device or the outside (PLC) device. The [Device Specification Start Address] stores the device code and address code in three consecutive words. It displays the word addresses that house the device code and address code.</p> <p>e.g.) [Monitor Word Address] is CN35, Indirectly designated [Device Specification Start Address] = D100 [Address Mode] = External (PLC) Device [Device Code] = CN: 0061</p> <div style="display: flex; justify-content: space-around; align-items: flex-start;"> <div style="text-align: center;"> <p>In the device/PLC</p> <table border="1" style="border-collapse: collapse;"> <tr><td>D100</td><td style="text-align: center;">0</td><td>Address Mode^{*1}</td></tr> <tr><td>D101</td><td style="text-align: center;">0061</td><td>Device Code^{*2}</td></tr> <tr><td>D102</td><td style="text-align: center;">35</td><td>Address Code(L)</td></tr> <tr><td>D103</td><td style="text-align: center;">0</td><td>Address Code(H)</td></tr> </table> </div> <div style="text-align: center;"> <p>GP unit</p>  </div> </div> <p>^{*1} Address Mode 0: External (PLC) Device 1: Internal Device In the above case, 0 is stored.</p> <p>^{*2} Please see the "GP-Pro EX Device/PLC Connection Manual" for device codes. If you select an internal device, the device codes are LS area: 0000 and USR area: 0001.</p> <p>The address designated by D100, D101, D102, and D103 is CN35. Its data, "40" is displayed.</p>	D100	0	Address Mode ^{*1}	D101	0061	Device Code ^{*2}	D102	35	Address Code(L)	D103	0	Address Code(H)
D100	0	Address Mode ^{*1}													
D101	0061	Device Code ^{*2}													
D102	35	Address Code(L)													
D103	0	Address Code(H)													

NOTE

- If the indirectly-designated address is out of range or does not exist, a communication error will occur. An error can affect the screen update. When an error occurs, check the indirectly-designated data and write the correct value to the device/PLC's address to restore the screen update.

On the [Basic Settings] tab's Detail screen, when you set [Address Type] to [Address] or [Device Type & Address], and set the [Input Display Settings]'s [Input Specification] and [Display Specification] to [Address], the address that stores the max/min values for the Input Range/Display Range will be automatically allotted to the addresses following the Monitor Word Address.

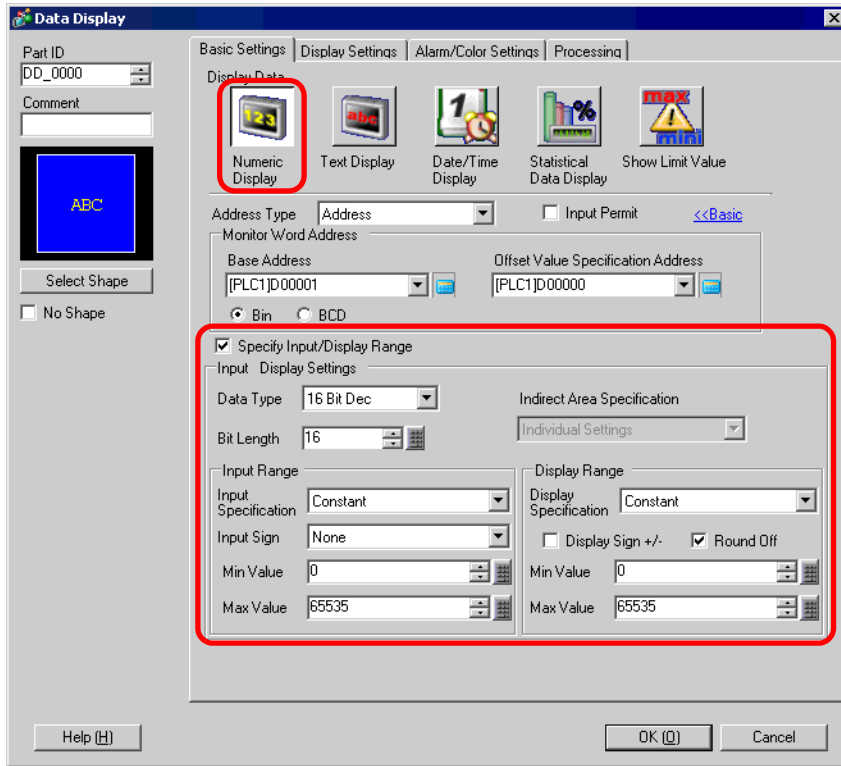

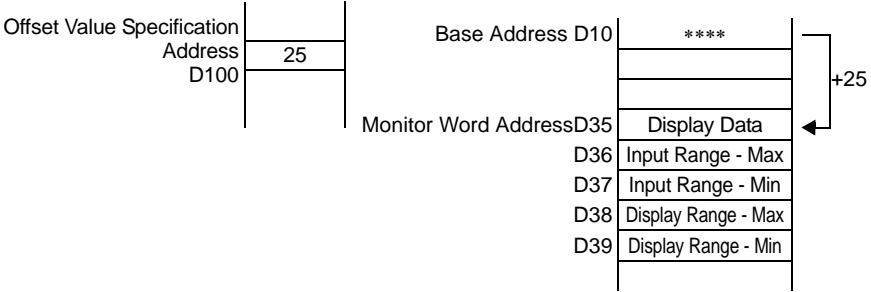

Setting	Description						
Specify Input/Display Range	<p>Specify an input/display range and [Monitor Word Address] data will automatically convert to correspond with the input and display range. The resulting numeric values can be displayed. (Display relative values) e.g.)</p>						
Data Type	<p>Select the type of data to be displayed.</p> <table border="1"> <thead> <tr> <th>Bit Length</th> <th>Data Type</th> </tr> </thead> <tbody> <tr> <td>16 Bit</td> <td>Dec, Hex, Oct, Bin, BCD</td> </tr> <tr> <td>32 bit</td> <td>Dec, Hex, Bin, BCD, Float</td> </tr> </tbody> </table>	Bit Length	Data Type	16 Bit	Dec, Hex, Oct, Bin, BCD	32 bit	Dec, Hex, Bin, BCD, Float
Bit Length	Data Type						
16 Bit	Dec, Hex, Oct, Bin, BCD						
32 bit	Dec, Hex, Bin, BCD, Float						
Bit Length	<p>Specify the address' valid bit length from 1 to 16. This can only be set when the [Data Type] is [16 Bit Bin].</p>						

Continued

Setting	Description				
Indirect Area Specification	<p>If [Input Specification] and [Display Specification] are both [Address], choose the indirect designation method from [Individual Settings] or [Area After Display Address] for the word addresses which will store the Input Range and Display Range's upper/lower limit value.</p> <p>If either [Input Specification] or [Display Specification] is set to [Constant], the setting will be fixed as [Individual Settings].</p> <ul style="list-style-type: none"> • Individual Settings The [Min Value] and [Max Value] will be separately set to a numeric value or a word address. • Area After Display Address The input and display ranges are automatically allocated according to the indirectly specified display data address. The allocated addresses follow consecutively after the [Monitor Word Address]: (Input Range - Max.) → (Input Range - Min.) → (Display Range - Max.) → (Display Range - Min.) <p>e.g.) When [Indirect Area Specification] is set to [Area After Display Address], the min/max values for the input/display range will be as follows: [Base Address] = D10, [Offset Value Specification Address] = D100 [Monitor Word Address] = D35 [Input Specification] = [Address], [Display Specification] = [Address]</p> 				
Input Range	<table border="1"> <tr> <td data-bbox="248 1290 371 1503">Input Specification</td> <td data-bbox="371 1290 1259 1503"> <p>Choose how the input range's max and min values will be specified.</p> <ul style="list-style-type: none"> • Constant Designate a set constant as the Min/Max value. (Direct Specification) • Address Designate the address where the Min/Max Values are stored. (Indirect Specification) </td> </tr> <tr> <td data-bbox="248 1503 371 1783">Input Sign</td> <td data-bbox="371 1503 1259 1783"> <p>Specifies whether inputted data will be able to handle negative numeric data.</p> <ul style="list-style-type: none"> • None Only positive numeric data. • 2's Complement Negative numbers are handled with 2's complement. • MSB Sign Negative numbers are handled with MSB sign. </td> </tr> </table>	Input Specification	<p>Choose how the input range's max and min values will be specified.</p> <ul style="list-style-type: none"> • Constant Designate a set constant as the Min/Max value. (Direct Specification) • Address Designate the address where the Min/Max Values are stored. (Indirect Specification) 	Input Sign	<p>Specifies whether inputted data will be able to handle negative numeric data.</p> <ul style="list-style-type: none"> • None Only positive numeric data. • 2's Complement Negative numbers are handled with 2's complement. • MSB Sign Negative numbers are handled with MSB sign.
Input Specification	<p>Choose how the input range's max and min values will be specified.</p> <ul style="list-style-type: none"> • Constant Designate a set constant as the Min/Max value. (Direct Specification) • Address Designate the address where the Min/Max Values are stored. (Indirect Specification) 				
Input Sign	<p>Specifies whether inputted data will be able to handle negative numeric data.</p> <ul style="list-style-type: none"> • None Only positive numeric data. • 2's Complement Negative numbers are handled with 2's complement. • MSB Sign Negative numbers are handled with MSB sign. 				

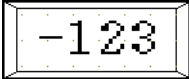
Continued

Setting		Description																																																																				
Display Range	Display Specification	<p>Choose how the display range's max and min value will be specified.</p> <ul style="list-style-type: none"> Constant Designate a set constant as the Min/Max value. (Direct Specification) Address Designate the address where the Min/Max Values are stored. (Indirect Specification) 																																																																				
	Round Off	Select whether or not fractions get rounded off when data is displayed.																																																																				
	Display Sign +/-	<p>Specify whether or not negative numbers will be displayed. This can be set when the [Data Type] is [Dec]. e.g.) When the data “-123” has been written</p> <div style="display: flex; justify-content: space-around; align-items: center;"> <div style="text-align: center;"> <input checked="" type="checkbox"/> Display Sign +/-  Negative numbers displayed </div> <div style="text-align: center;"> <input type="checkbox"/> Display Sign +/-  Negative numbers not displayed </div> </div>																																																																				
Input Range/ Display Range	Min. Value/ Max. Value	<p>Select the input range and display range for the numeric display data. If [Input Specification] or [Display Specification] is [Constant], you can input a min/max value. If [Address] is set, specify the word address where the min/max value will be stored. Each [Data Type], [Input Sign], and [Display Sign +/-] has a different size range.</p> <table border="1" style="width: 100%; border-collapse: collapse;"> <thead> <tr> <th>Bit Length</th> <th>Data Type</th> <th>Input Sign</th> <th>Input Range</th> <th>Display Sign +/-</th> <th>Display Range</th> </tr> </thead> <tbody> <tr> <td rowspan="15" style="text-align: center; vertical-align: middle;">16 Bit</td> <td rowspan="6" style="text-align: center; vertical-align: middle;">Dec</td> <td>None</td> <td>0 to 65535</td> <td>Unchecked</td> <td>0 to 65535</td> </tr> <tr> <td rowspan="2">2's Complement</td> <td rowspan="2">-32,768 to 32,767</td> <td>Unchecked</td> <td>0 to 65535</td> </tr> <tr> <td>Checked</td> <td>-32,768 to 32,767</td> </tr> <tr> <td rowspan="2">MSB Sign</td> <td rowspan="2">-32767 to 73276</td> <td>Unchecked</td> <td>0 to 65535</td> </tr> <tr> <td>Checked</td> <td>-32,768 to 32,767</td> </tr> <tr> <td rowspan="3" style="text-align: center; vertical-align: middle;">Hex</td> <td>None</td> <td>0 to 65535</td> <td>-</td> <td>0 to FFFF(h)</td> </tr> <tr> <td rowspan="2">2's Complement</td> <td rowspan="2">-32,768 to 32,767</td> <td>-</td> <td>0 to FFFF(h)</td> </tr> <tr> <td>MSB Sign</td> <td>-32767 to 32767</td> <td>-</td> <td>0 to FFFF(h)</td> </tr> <tr> <td rowspan="3" style="text-align: center; vertical-align: middle;">Oct</td> <td>None</td> <td>0 to 65535</td> <td>-</td> <td>0 to 177777(o)</td> </tr> <tr> <td rowspan="2">2's Complement</td> <td rowspan="2">-32,768 to 32,767</td> <td>-</td> <td>0 to 177777(o)</td> </tr> <tr> <td>MSB Sign</td> <td>-32767 to 32767</td> <td>-</td> <td>0 to 177777(o)</td> </tr> <tr> <td>BCD</td> <td>-</td> <td>0 to 9999</td> <td>-</td> <td>0 to 9999</td> </tr> <tr> <td rowspan="3" style="text-align: center; vertical-align: middle;">Bin</td> <td>None</td> <td>0 to 65535</td> <td>-</td> <td>0 to FFFF(h)</td> </tr> <tr> <td rowspan="2">2's Complement</td> <td rowspan="2">-32,768 to 32,767</td> <td>-</td> <td>0 to FFFF(h)</td> </tr> <tr> <td>MSB Sign</td> <td>-32767 to 32767</td> <td>-</td> <td>0 to FFFF(h)</td> </tr> </tbody> </table>	Bit Length	Data Type	Input Sign	Input Range	Display Sign +/-	Display Range	16 Bit	Dec	None	0 to 65535	Unchecked	0 to 65535	2's Complement	-32,768 to 32,767	Unchecked	0 to 65535	Checked	-32,768 to 32,767	MSB Sign	-32767 to 73276	Unchecked	0 to 65535	Checked	-32,768 to 32,767	Hex	None	0 to 65535	-	0 to FFFF(h)	2's Complement	-32,768 to 32,767	-	0 to FFFF(h)	MSB Sign	-32767 to 32767	-	0 to FFFF(h)	Oct	None	0 to 65535	-	0 to 177777(o)	2's Complement	-32,768 to 32,767	-	0 to 177777(o)	MSB Sign	-32767 to 32767	-	0 to 177777(o)	BCD	-	0 to 9999	-	0 to 9999	Bin	None	0 to 65535	-	0 to FFFF(h)	2's Complement	-32,768 to 32,767	-	0 to FFFF(h)	MSB Sign	-32767 to 32767	-	0 to FFFF(h)
Bit Length	Data Type	Input Sign	Input Range	Display Sign +/-	Display Range																																																																	
16 Bit	Dec	None	0 to 65535	Unchecked	0 to 65535																																																																	
		2's Complement	-32,768 to 32,767	Unchecked	0 to 65535																																																																	
				Checked	-32,768 to 32,767																																																																	
		MSB Sign	-32767 to 73276	Unchecked	0 to 65535																																																																	
				Checked	-32,768 to 32,767																																																																	
		Hex	None	0 to 65535	-	0 to FFFF(h)																																																																
	2's Complement		-32,768 to 32,767	-	0 to FFFF(h)																																																																	
				MSB Sign	-32767 to 32767	-	0 to FFFF(h)																																																															
	Oct	None	0 to 65535	-	0 to 177777(o)																																																																	
		2's Complement	-32,768 to 32,767	-	0 to 177777(o)																																																																	
				MSB Sign	-32767 to 32767	-	0 to 177777(o)																																																															
	BCD	-	0 to 9999	-	0 to 9999																																																																	
	Bin	None	0 to 65535	-	0 to FFFF(h)																																																																	
		2's Complement	-32,768 to 32,767	-	0 to FFFF(h)																																																																	
				MSB Sign	-32767 to 32767	-	0 to FFFF(h)																																																															

Continued

Setting		Description							
Input Range/ Display Range	Min. Value/ Max. Value	Bit Length	Data Type	Input Sign	Input Range	Display Sign +/-	Display Range		
		32 bit	Dec	None	0 to 4294967295	Unchecked	0 to 4294967295		
						Checked	-2147483648 to 2147483647		
				2's Complement	-2147483648 to 2147483647	Unchecked	0 to 4294967295		
						Checked	-2147483648 to 2147483647		
				MSB Sign	-2147483647 to 2147483647	Unchecked	0 to 4294967295		
						Checked	-2147483648 to 2147483647		
			Hex	None	0 to 4294967295	-	0 to FFFFFFFF(h)		
						2's Complement	-2147483648 to 2147483647	-	0 to FFFFFFFF(h)
								MSB Sign	-2147483647 to 2147483647
			BCD	-	0 to 99999999	-	0 to 99999999		
			Bin	None	0 to 4294967295	-	0 to FFFFFFFF(h)		
						2's Complement	-2147483648 to 2147483647	-	0 to FFFFFFFF(h)
		MSB Sign						-2147483647 to 2147483647	-
			Float	-	- 9.9e ¹⁶ to 9.9e ¹⁶	-	- 9.9e ¹⁶ to 9.9e ¹⁶		

NOTE • The Input Range and Display Range are used to decide how the values will be automatically converted and displayed. If a value outside of the Input Range is entered and converted, it will also appear outside of the Display Range.

■ Input Permit/Basic

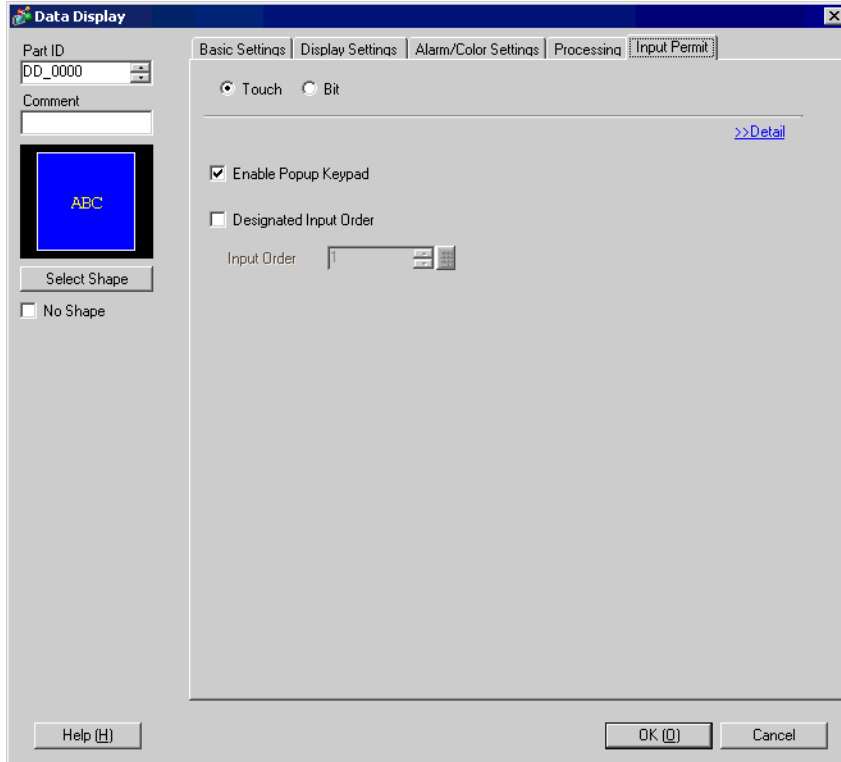

Setting	Description
<p>Input Permit Methods</p>	<p>Select the method which will make the Data Display go into the input state (cursor display state).</p> <ul style="list-style-type: none"> • Touch Touch the Data Display and it goes into the Input Permit state.

Continued

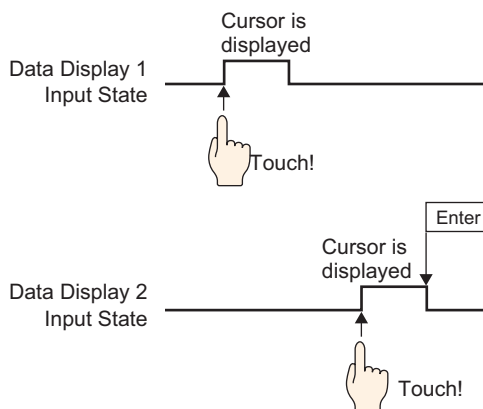
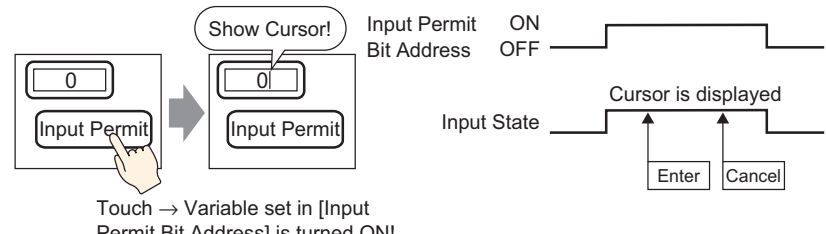
Setting	Description
<p>Input Permit Methods</p>	<p>NOTE</p> <ul style="list-style-type: none"> If you touch a Data Display while inputting data into another Data Display, the inputted data will revert to its previous data, and the most recently touched part will enter the Input Permit state.  <p>Touch Data Display 1 and without deciding touch Data Display 2 and...</p> <ul style="list-style-type: none"> Bit When the Input Permit Bit Address is ON, the Data Display is in the Input Permit state.  <p>Touch → Variable set in [Input Permit Bit Address] is turned ON!</p> <p>NOTE</p> <ul style="list-style-type: none"> If the [Input Permit Bit Address] turns OFF while inputting data in a Data Display, the Input Permit state is cancelled, and the input data is erased.

Continued

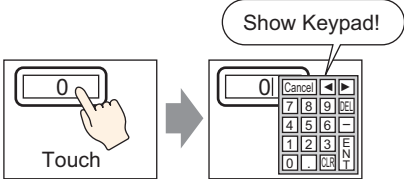
Setting	Description
Touch	
Enable Popup Keypad	<p>Select whether or not a popup keypad will display when you touch the Data Display part.</p>  <p>NOTE</p> <ul style="list-style-type: none"> • A popup keypad cannot be used when the Data Display is placed on a Window screen.
Designated Input Order	<p>When you will be inputting into multiple Data Displays in sequence, select the order in which they will enter the input state.</p> <p>☞ “14.13 How Data Input Order Works” (page 14-106)</p>
Input Order	<p>Select the order, from 1 to 384, in which the Part will enter the input state.</p>

Continued

■ Input Permit/Details

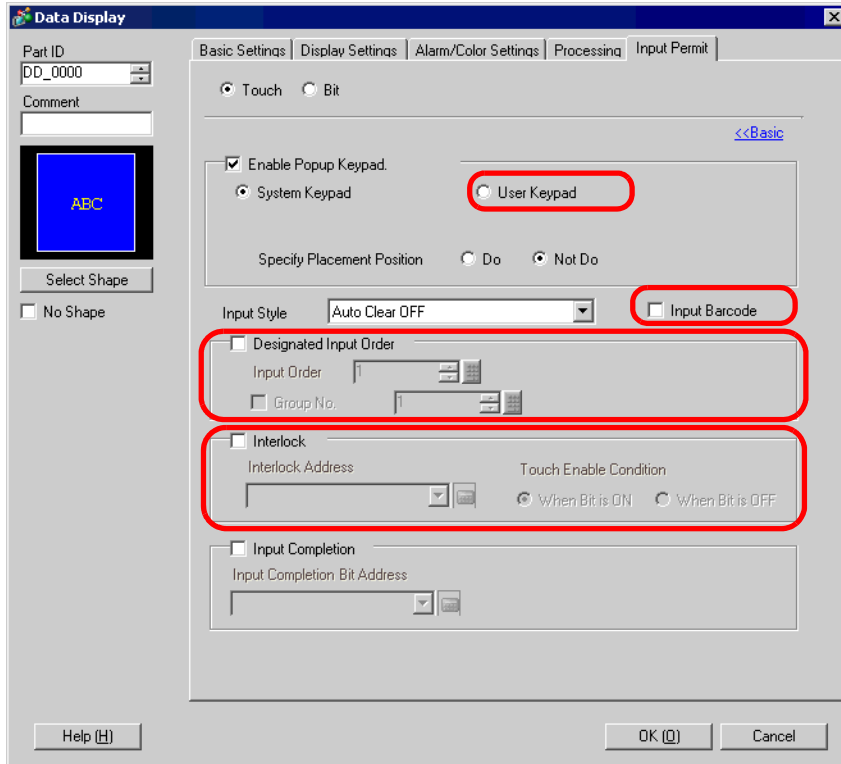

Setting		Description
Touch	Enable Popup Keypad	Select whether or not a popup keypad will display when you touch the Data Display part. NOTE <ul style="list-style-type: none"> A popup keypad cannot be used when the Data Display is placed on a Window screen.
	Keypad Type	<ul style="list-style-type: none"> System Keypad Use a standard keypad pre-set by GP-Pro EX. This is the typically used keypad. User Keypad Create a user-defined keypad with the Keypad part. This keypad allows for customized input. <ul style="list-style-type: none"> ☞ “16.4.2 Setup Procedure ■ Displaying the Customized Keypad as a Popup” (page 16-15)

Continued

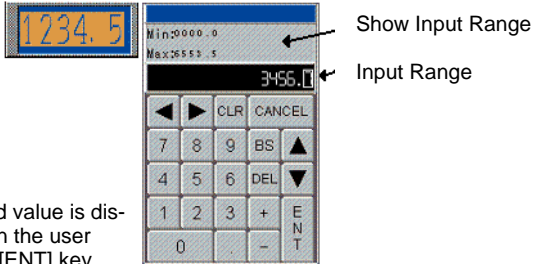
Setting		Description	
Touch	System Keypad	<p>The standard keypad provided by GP-Pro EX is displayed.</p>  <p>The inputted value is displayed when the user pushes the [ENT] key.</p>	
	User Keypad	Keypad No.	Set the number of the custom-made keypad.
	Specify Placement Position		<p>Select whether or not to set the popup keypad's display position. If [Do] is selected, the popup keypad's Display Area can be selected and moved after the Data Display part is positioned.</p> <p>NOTE</p> <ul style="list-style-type: none"> If the Data Display is grouped with other objects, you cannot select or move the popup keypad's Display Area.
	Designated Input Order		<p>When you will be inputting into multiple Data Displays in sequence, select the order in which they will enter the input state.</p> <p>☞ "14.13 How Data Input Order Works" (page 14-106)</p>
		Input Order	Select the order, from 1 to 384, in which the Part will enter the input state.
		Group No.	<p>Divide the Data Displays into groups for continuous data input. The cursor will move in turn to each successive Data Display registered in the same group, according to the input order, setting them into the Input Permit state. The Group No. can be from 1 to 10.</p> <p>☞ "14.13.2 Set Input Order by Group" (page 14-107)</p>
	Interlock		<p>This function only allows input when a bit designated via [Interlock Address] is in a state that has been selected via [Touch Enable Condition]. Select whether or not to use the Interlock function.</p> <p>☞ "14.7 Preventing Operational Errors (Interlock)" (page 14-26)</p>
	Interlock Address		Select the bit address that will designate the enable condition, to allow input to be entered. This address' state will determine if touch is enabled or disabled.

Continued

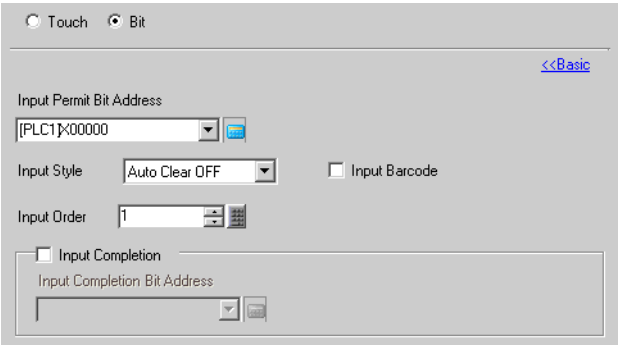
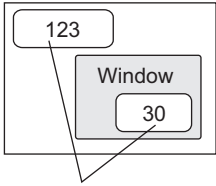
Setting		Description													
Touch	Touch Enable Condition	<p>Select the condition that will enable the part to be touched, to allow input to be entered.</p> <table border="1"> <thead> <tr> <th>Touch Enable Condition</th> <th>Interlock Address Status</th> <th>Touch Enabled/Disabled</th> </tr> </thead> <tbody> <tr> <td rowspan="2">When Bit is ON</td> <td>ON</td> <td>Touch enabled</td> </tr> <tr> <td>OFF</td> <td>Touch disabled</td> </tr> <tr> <td rowspan="2">When Bit is OFF</td> <td>ON</td> <td>Touch disabled</td> </tr> <tr> <td>OFF</td> <td>Touch enabled</td> </tr> </tbody> </table> <p>NOTE</p> <ul style="list-style-type: none"> When Interlock's [Touch Enable Condition] is disabled while you are inputting, the Data Display will remain in the Input Permit state. Interlock will not work until the input is completed. 	Touch Enable Condition	Interlock Address Status	Touch Enabled/Disabled	When Bit is ON	ON	Touch enabled	OFF	Touch disabled	When Bit is OFF	ON	Touch disabled	OFF	Touch enabled
	Touch Enable Condition	Interlock Address Status	Touch Enabled/Disabled												
When Bit is ON	ON	Touch enabled													
	OFF	Touch disabled													
When Bit is OFF	ON	Touch disabled													
	OFF	Touch enabled													
Bit															
	Input Permit Bit Address	When the bit address set here turns ON, the Data Display enters the input state.													
	Input Order	<p>Select the order from 1 to 384 that the Part will enter the Input Permit state if multiple [Input Permit Bit Addresses] turn ON at the same time (when a bit address has been registered to multiple Data Display parts, or when different bit addresses turn ON at the same time).</p> <p>NOTE</p> <ul style="list-style-type: none"> If more than one [Input Permit Bit Address] is turned ON at the same time, the Data Displays will enter the input state according to their [Input Order] settings. If the [Input Order] settings are the same, the input state order will be determined by the order the parts were placed. If the [Input Permit Bit Address] of Data Displays placed on the Base Screen and Window Screen turn ON at the same time, the Base Screen will have a higher priority for the input state than the Window Screen. When placing Data Displays on both the Base and Window screen, make sure to set a different [Input Permit Bit Address].  <p>Multiple [Input Permit Bit Addresses] turn ON simultaneously</p>													

Continued

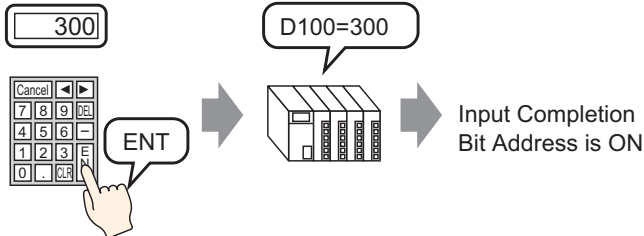
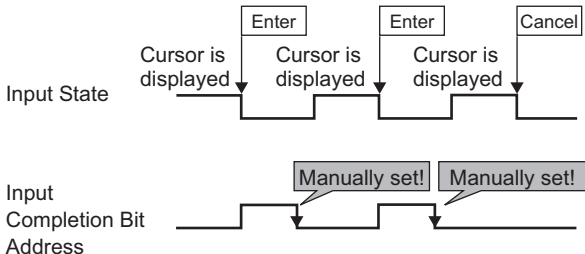
Setting	Description
Input Style	<ul style="list-style-type: none"> • Auto Clear OFF New data will build on previously inputted data. Pressing [CLR] on the keypad clears the value. • Auto Clear ON The first key pressed (except [ENT], [DEL], or [BS]) will clear the previously inputted data. • Auto Clear ON + Input Check When using barcode input, checks whether the number of inputted digits coincides with the [No. of Display Digits] when an automatic clear occurs. If they do not coincide, the data will not be written to the word address.
Input Barcode	<p>A setting that allows input from a barcode reader.  "8.2.2 Setup Procedure" (page 8-5)</p>
Input Completion	<p>Detects and notifies you when input has been completed.</p> 
Input Completion Bit Address	<p>Sets the bit address that will turn ON when input has been completed.</p>  <p>NOTE</p> <ul style="list-style-type: none"> • Please return this bit to OFF after input has been completed.

■ Display Settings/Basic

Sets the font and attributes of the Numeric Display.

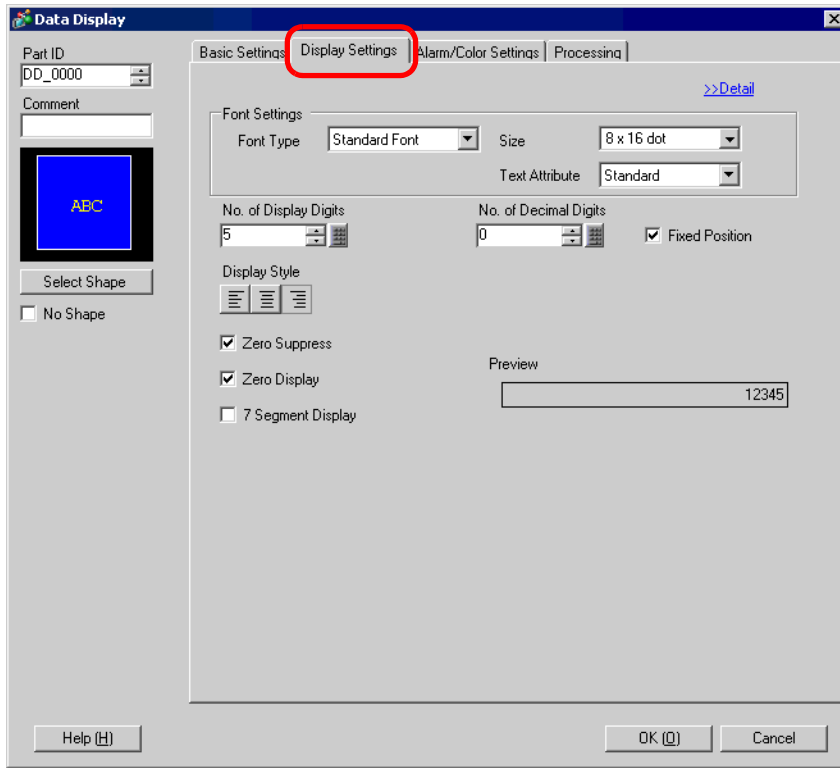

Setting	Description
Font Settings	Sets a font for the numeric values.
Font Type	Select a font type for the numeric values from [Standard Font] or [Stroke Font].
Size	Chooses a font size for the numeric values. Standard Font: (8 to 64) × (8 to 128) Standard Font (Fixed Size): [6 × 10], [8 × 13], [13 × 23] Stroke Font: Select from 6 to 127.
Text Attribute	Select the font's text attributes. Standard Font: Choose from [Standard], [Bold], [Shadow] Standard Font (Fixed Size): Choose from [Standard], [Shadow] Stroke Font: Choose from [Standard], [Bold], [Outline] NOTE • If [7 Segment Display] is set, [Text Attribute] cannot be set.

Continued

Setting	Description																																						
No. of Display Digits No. of Decimal Digits	<p>Select the number of digits to display in the numeric display with [No. of Display Digits]. Numbers after the decimal point are included in the display digits. However, the decimal point is not included in the display digits. Select the number of digits after the decimal point with [No. of Decimal Digits]. This can only be set when the [Data Type] is [Dec], [BCD], or [Float]. e.g.)</p> <p>When the No. of Display Digits is 5, and the No. of Decimal Places is 2, it will look as follows:</p> <div style="text-align: center; border: 1px solid black; padding: 5px; width: fit-content; margin: 10px auto;">123.45</div> <p>Each digit number range is different, depending on the [Data Type].</p> <table border="1" data-bbox="395 562 1236 942"> <thead> <tr> <th rowspan="2">Data Length</th> <th rowspan="2">Data Type</th> <th>No. of Display Digits</th> <th>No. of Decimal Digits</th> </tr> <tr> <th colspan="2">Setting Range</th> </tr> </thead> <tbody> <tr> <td rowspan="5" style="text-align: center;">16 Bit</td> <td style="text-align: center;">Dec</td> <td style="text-align: center;">1 to 11</td> <td style="text-align: center;">0 to 10</td> </tr> <tr> <td style="text-align: center;">Hex</td> <td style="text-align: center;">1 to 11</td> <td style="text-align: center;">—</td> </tr> <tr> <td style="text-align: center;">BCD</td> <td style="text-align: center;">1 to 11</td> <td style="text-align: center;">0 to 10</td> </tr> <tr> <td style="text-align: center;">Oct</td> <td style="text-align: center;">1 to 11</td> <td style="text-align: center;">—</td> </tr> <tr> <td style="text-align: center;">Bin</td> <td style="text-align: center;">1 to 16</td> <td style="text-align: center;">—</td> </tr> <tr> <td rowspan="5" style="text-align: center;">32 bit</td> <td style="text-align: center;">Dec</td> <td style="text-align: center;">1 to 11</td> <td style="text-align: center;">0 to 10</td> </tr> <tr> <td style="text-align: center;">Hex</td> <td style="text-align: center;">1 to 11</td> <td style="text-align: center;">—</td> </tr> <tr> <td style="text-align: center;">BCD</td> <td style="text-align: center;">1 to 11</td> <td style="text-align: center;">0 to 10</td> </tr> <tr> <td style="text-align: center;">Bin</td> <td style="text-align: center;">1 to 32</td> <td style="text-align: center;">—</td> </tr> <tr> <td style="text-align: center;">Float</td> <td style="text-align: center;">1 to 17</td> <td style="text-align: center;">0 to 16</td> </tr> </tbody> </table>	Data Length	Data Type	No. of Display Digits	No. of Decimal Digits	Setting Range		16 Bit	Dec	1 to 11	0 to 10	Hex	1 to 11	—	BCD	1 to 11	0 to 10	Oct	1 to 11	—	Bin	1 to 16	—	32 bit	Dec	1 to 11	0 to 10	Hex	1 to 11	—	BCD	1 to 11	0 to 10	Bin	1 to 32	—	Float	1 to 17	0 to 16
Data Length	Data Type			No. of Display Digits	No. of Decimal Digits																																		
		Setting Range																																					
16 Bit	Dec	1 to 11	0 to 10																																				
	Hex	1 to 11	—																																				
	BCD	1 to 11	0 to 10																																				
	Oct	1 to 11	—																																				
	Bin	1 to 16	—																																				
32 bit	Dec	1 to 11	0 to 10																																				
	Hex	1 to 11	—																																				
	BCD	1 to 11	0 to 10																																				
	Bin	1 to 32	—																																				
	Float	1 to 17	0 to 16																																				
Fixed Position	Set whether or not the Numeric Value will be fixed in the center of the Part.																																						
Display Style	Select the alignment of the numeric display area's numeric value: [Align Right], [Align Left], or [Align Center].																																						
Zero Suppress	If this option is selected, leading zeros are not displayed. e.g.) When No. of Display Digits = 4 <div style="display: flex; justify-content: space-around; margin-top: 10px;"> <div style="text-align: center;"> <input checked="" type="checkbox"/> Zero Suppress <input style="width: 50px;" type="text" value="25"/> Leading zeroes are not displayed </div> <div style="text-align: center;"> <input type="checkbox"/> Zero Suppress <input style="width: 50px;" type="text" value="0025"/> Zeroes are added to correspond to the length of Display Digits </div> </div>																																						
Zero Display	Displays "0" when the data is zero.																																						
7 Segment Display	Data will be displayed using the 7 segment display setting. <div style="border: 1px solid black; padding: 2px; margin: 5px 0;">NOTE</div> <ul style="list-style-type: none"> This cannot be set if the [Display Format] option is set on the [Basic Settings] tab's [Detail] screen. 																																						
Preview	Displays the data's image according to the settings.																																						

■ Display Settings/Detail

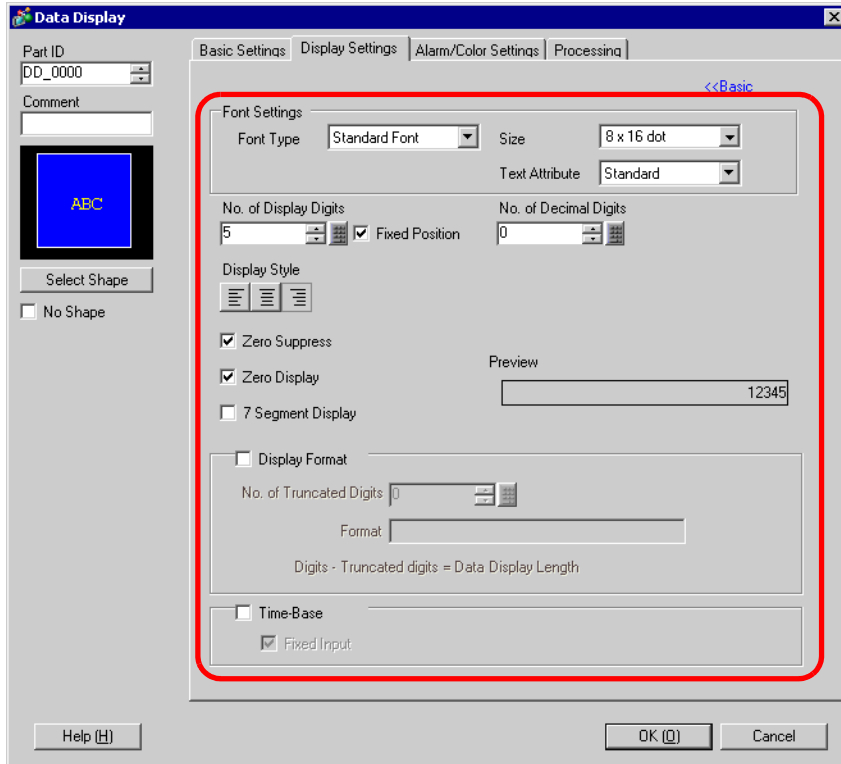

Setting	Description
Font Settings	Sets a font for the numeric values.
Font Type	Select a font type for the numeric values from [Standard Font] or [Stroke Font].
Size	Chooses a font size for the numeric values. Standard Font: (8 to 64) × (8 to 128) Standard Font (Fixed Size): [6 × 10], [8 × 13], [13 × 23] Stroke Font: 6 to 127
Text Attribute	Select the font's text attributes. Standard Font: Choose from [Standard], [Bold], [Shadow] Standard Font (Fixed Size): Choose from [Standard], [Shadow] Stroke Font: Choose from [Standard], [Bold], [Outline] NOTE • If [7 Segment Display] is set, [Text Attribute] cannot be set.

Continued

Setting	Description																																						
No. of Display Digits No. of Decimal Digits	<p>Select the number of digits to display in the numeric display with [No. of Display Digits]. Numbers after the decimal point are included in the display digits. However, the decimal point is not included in the display digits. Select the number of digits after the decimal point with [No. of Decimal Digits]. This can only be set when the [Data Type] is [Dec], [BCD], or [Float]. e.g.)</p> <p>When the No. of Display Digits is 5, and the No. of Decimal Places is 2, it will look as follows:</p> <div style="text-align: center; border: 1px solid black; width: fit-content; margin: 0 auto; padding: 2px;">123.45</div> <p>Each digit number range is different, depending on the [Data Type].</p> <table border="1" data-bbox="395 523 1233 904"> <thead> <tr> <th rowspan="2">Data Length</th> <th rowspan="2">Data Type</th> <th>No. of Display Digits</th> <th>No. of Decimal Digits</th> </tr> <tr> <th colspan="2">Setting Range</th> </tr> </thead> <tbody> <tr> <td rowspan="5">16 Bit</td> <td>Dec</td> <td>1 to 11</td> <td>0 to 10</td> </tr> <tr> <td>Hex</td> <td>1 to 11</td> <td>—</td> </tr> <tr> <td>BCD</td> <td>1 to 11</td> <td>0 to 10</td> </tr> <tr> <td>Oct</td> <td>1 to 11</td> <td>—</td> </tr> <tr> <td>Bin</td> <td>1 to 16</td> <td>—</td> </tr> <tr> <td rowspan="5">32 bit</td> <td>Dec</td> <td>1 to 11</td> <td>0 to 10</td> </tr> <tr> <td>Hex</td> <td>1 to 11</td> <td>—</td> </tr> <tr> <td>BCD</td> <td>1 to 11</td> <td>0 to 10</td> </tr> <tr> <td>Bin</td> <td>1 to 32</td> <td>—</td> </tr> <tr> <td>Float</td> <td>1 to 17</td> <td>0 to 16</td> </tr> </tbody> </table>	Data Length	Data Type	No. of Display Digits	No. of Decimal Digits	Setting Range		16 Bit	Dec	1 to 11	0 to 10	Hex	1 to 11	—	BCD	1 to 11	0 to 10	Oct	1 to 11	—	Bin	1 to 16	—	32 bit	Dec	1 to 11	0 to 10	Hex	1 to 11	—	BCD	1 to 11	0 to 10	Bin	1 to 32	—	Float	1 to 17	0 to 16
Data Length	Data Type			No. of Display Digits	No. of Decimal Digits																																		
		Setting Range																																					
16 Bit	Dec	1 to 11	0 to 10																																				
	Hex	1 to 11	—																																				
	BCD	1 to 11	0 to 10																																				
	Oct	1 to 11	—																																				
	Bin	1 to 16	—																																				
32 bit	Dec	1 to 11	0 to 10																																				
	Hex	1 to 11	—																																				
	BCD	1 to 11	0 to 10																																				
	Bin	1 to 32	—																																				
	Float	1 to 17	0 to 16																																				
Fixed Position	Set whether or not the Numeric Value will be fixed in the center of the Part.																																						
Display Style	Select the alignment of the numeric display area's numeric value: [Align Right], [Align Left], or [Align Center].																																						
Zero Suppress	If this option is selected, leading zeros are not displayed. e.g.) When No. of Display Digits = 4 <div style="display: flex; justify-content: space-around; margin-top: 10px;"> <div style="text-align: center;"> <input checked="" type="checkbox"/> Zero Suppress <input style="width: 40px;" type="text" value="25"/> Leading zeroes are not displayed </div> <div style="text-align: center;"> <input checked="" type="checkbox"/> Zero Suppress <input style="width: 40px;" type="text" value="0025"/> Zeroes are added to correspond to the length of Display Digits </div> </div>																																						
Zero Display	Displays "0" when the data is zero.																																						
7 Segment Display	Data will be displayed using the 7 segment display setting. <div style="border: 1px solid black; padding: 2px; margin: 5px 0;">NOTE</div> <ul style="list-style-type: none"> This cannot be set if the [Display Format] option is set on the [Basic Settings] tab's [Detail] screen. This cannot be set when [Size] is [Fixed Size]. 																																						
Preview	Displays the data's image according to the settings.																																						
Display Format	Select whether or not to use a Display Format. <div style="border: 1px solid black; padding: 2px; margin: 5px 0;">NOTE</div> <ul style="list-style-type: none"> This option cannot be selected when, in the [Basic Setting] tab, [Input Permit] is selected. This option cannot be set when [Data Type] is [Bin] on the [Basic Settings] tab. 																																						
No. of Truncated Digits	Designate how many numeric data digits to truncate (0 to 10). This can only be set when the [Data Type] is [Dec] or [BCD] on the [Basic Settings] tab. When there are no digits to truncate, a value of zero is set.																																						

Continued

Setting	Description																																									
<p style="writing-mode: vertical-rl; transform: rotate(180deg);">Display Format</p> <p>Format</p> <p>Digits - Truncated digits = Data Display Length</p>	<p>Set the Display Format. The portion which will display data is inputted with an asterisk “*”. Together with the format character portion, it must not exceed 80 characters. The numeric value displays in the asterisks “*” from the lowest position.</p> <p>Select the settings so that the No. of Display Digits - Truncated digits = No of “*”.</p> <p>e.g.) [No. of Display Digits] = 6, [No. of Truncated Digits] = 2, [Display Style] = Align Right [Zero Suppress] = OFF, [Format] = ***Kg *00g</p> <div style="display: flex; justify-content: space-around; align-items: flex-start;"> <div style="text-align: center;"> <p>Display Data</p> <table border="1" style="border-collapse: collapse; width: 100px;"> <tr><td style="width: 20px; height: 20px;"></td><td style="width: 20px; height: 20px;"></td><td style="width: 20px; height: 20px; text-align: center;">1</td><td style="width: 20px; height: 20px; text-align: center;">2</td><td style="width: 20px; height: 20px; text-align: center;">3</td><td style="width: 20px; height: 20px; text-align: center;">4</td><td style="width: 20px; height: 20px; text-align: center;">5</td><td style="width: 20px; height: 20px; text-align: center;">6</td></tr> </table> </div> <div style="text-align: center;"> <p>Display</p> <p>→ 123Kg400g</p> </div> <div style="text-align: center;"> <p>Format's text portion</p> </div> </div> <div style="display: flex; justify-content: space-around; align-items: flex-start; margin-top: 10px;"> <div style="text-align: center;"> <table border="1" style="border-collapse: collapse; width: 100px;"> <tr><td style="width: 20px; height: 20px;"></td><td style="width: 20px; height: 20px;"></td><td style="width: 20px; height: 20px;"></td><td style="width: 20px; height: 20px;"></td><td style="width: 20px; height: 20px;"></td><td style="width: 20px; height: 20px; text-align: center;">1</td><td style="width: 20px; height: 20px; text-align: center;">2</td><td style="width: 20px; height: 20px; text-align: center;">3</td></tr> </table> </div> <div style="text-align: center;"> <p>→ 000Kg100g</p> </div> </div> <div style="display: flex; justify-content: space-around; align-items: flex-start; margin-top: 10px;"> <div style="text-align: center;"> <table border="1" style="border-collapse: collapse; width: 100px;"> <tr><td style="width: 20px; height: 20px; text-align: center;">1</td><td style="width: 20px; height: 20px; text-align: center;">2</td><td style="width: 20px; height: 20px; text-align: center;">3</td><td style="width: 20px; height: 20px; text-align: center;">4</td><td style="width: 20px; height: 20px; text-align: center;">5</td><td style="width: 20px; height: 20px; text-align: center;">6</td><td style="width: 20px; height: 20px; text-align: center;">7</td><td style="width: 20px; height: 20px; text-align: center;">8</td></tr> </table> </div> <div style="text-align: center;"> <p>→ 345Kg600g</p> </div> </div> <p>Data is entered starting from the lowest asterisk [*] field position. However, [No. of Truncated Digits] is set to [2], so data is entered starting from the 3rd right-side digit.</p> <p>Displays the calculation method which computes the number of asterisks “*” in the Display Format.</p>			1	2	3	4	5	6						1	2	3	1	2	3	4	5	6	7	8																	
		1	2	3	4	5	6																																			
					1	2	3																																			
1	2	3	4	5	6	7	8																																			
<p style="writing-mode: vertical-rl; transform: rotate(180deg);">Time-Base</p>	<p>Defines whether or not to use the Time-Base Function. This works only when the following devices are selected:</p> <ul style="list-style-type: none"> • Siemens AG: SIMATIC S7 3964(R)/RK512 • Siemens AG: SIMATIC S7 MPI direct • Siemens AG: SIMATIC S7 Ethernet • PROFIBUS International: PROFIBUS DP slave <p>When [Time-Base] is selected, data is displayed in the following format:</p> <p>Word Address</p> <div style="text-align: center; margin-bottom: 10px;"> <table border="1" style="border-collapse: collapse; width: 100%; margin: 0 auto;"> <tr> <td style="width: 33%; text-align: center;">15</td> <td style="width: 33%; text-align: center;">12 11</td> <td style="width: 33%; text-align: center;">0</td> </tr> <tr> <td style="text-align: center;">MODE</td> <td style="text-align: center;">Value1</td> <td style="text-align: center;">Value2</td> </tr> <tr> <td colspan="3" style="text-align: right; padding-right: 5px;">s</td> </tr> </table> </div> <p>Using the defined word address, the four most-significant bits specify the decimal point. Each four bit that follows specifies a number for up to three positions to the right of the decimal point.</p> <p>Displays the 4-digit value (including decimal points, spaces, and 0s) + “s” (5th digit).</p> <div style="display: flex; justify-content: space-around; align-items: flex-start; margin-top: 20px;"> <table border="1" style="border-collapse: collapse; text-align: center;"> <thead> <tr><th>Mode</th><th>Display</th></tr> </thead> <tbody> <tr><td>0h</td><td>0.01s</td></tr> <tr><td>1h</td><td>0.1s</td></tr> <tr><td>2h</td><td>1s</td></tr> <tr><td>3h</td><td>10s</td></tr> <tr><td>Other than 0-3h</td><td>10s</td></tr> </tbody> </table> <table border="1" style="border-collapse: collapse; text-align: center;"> <thead> <tr><th>0Ah</th><th>Space</th></tr> </thead> <tbody> <tr><td>0Bh</td><td>:</td></tr> <tr><td>0Ch</td><td>e</td></tr> <tr><td>0Dh</td><td>.</td></tr> <tr><td>0Eh</td><td>+</td></tr> <tr><td>0Fh</td><td>-</td></tr> </tbody> </table> </div> <p>When entering values other than 0h to 09h, displays as follows.</p> <p>Example: When Value 1=1, Value 2=2, and Value 3=3</p> <div style="display: flex; justify-content: space-around; align-items: center; margin-top: 10px;"> <div style="text-align: center;"> <table border="1" style="border-collapse: collapse; width: 80px;"> <tr><td style="width: 20px; height: 20px; text-align: center;">1</td><td style="width: 20px; height: 20px; text-align: center;">2</td><td style="width: 20px; height: 20px; text-align: center;">3</td><td style="width: 20px; height: 20px; text-align: center;">s</td></tr> </table> <p>Mode:1</p> </div> <div style="text-align: center;"> <table border="1" style="border-collapse: collapse; width: 80px;"> <tr><td style="width: 20px; height: 20px; text-align: center;">1</td><td style="width: 20px; height: 20px; text-align: center;">2</td><td style="width: 20px; height: 20px; text-align: center;">3</td><td style="width: 20px; height: 20px; text-align: center;">s</td></tr> </table> <p>Mode:2</p> </div> </div>	15	12 11	0	MODE	Value1	Value2	s			Mode	Display	0h	0.01s	1h	0.1s	2h	1s	3h	10s	Other than 0-3h	10s	0Ah	Space	0Bh	:	0Ch	e	0Dh	.	0Eh	+	0Fh	-	1	2	3	s	1	2	3	s
15	12 11	0																																								
MODE	Value1	Value2																																								
s																																										
Mode	Display																																									
0h	0.01s																																									
1h	0.1s																																									
2h	1s																																									
3h	10s																																									
Other than 0-3h	10s																																									
0Ah	Space																																									
0Bh	:																																									
0Ch	e																																									
0Dh	.																																									
0Eh	+																																									
0Fh	-																																									
1	2	3	s																																							
1	2	3	s																																							

Continued

Setting	Description																																																																													
Time-Base	<p data-bbox="385 166 1112 195">Specify if the decimal position is fixed when inputting values.</p> <ul data-bbox="385 200 584 229" style="list-style-type: none"> <li data-bbox="385 200 584 229">• When Enabled <p data-bbox="408 241 1243 340">Decimal point is fixed. When you input a decimal point, you can move the cursor before or after the decimal point. You can also move the cursor by pressing the “←” or “→” keys.</p> <p data-bbox="385 351 1251 484">e.g.) Input “2” Input “.” Input “3” Input “2” Input “.” 1 . 23s → 2 . 23s → 2 . 23s → 2 . 33s → 2 . 32s → 2 . 32s ↑ Cursor</p> <table border="1" data-bbox="408 511 1243 801"> <thead> <tr> <th rowspan="2">Input value</th> <th colspan="4">Value displayed on Data Display</th> </tr> <tr> <th>Mode0 (0.01s)</th> <th>Mode1 (0.1s)</th> <th>Mode2 (1s)^{*1}</th> <th>Mode3 (10s)^{*1}</th> </tr> </thead> <tbody> <tr> <td>0</td> <td>0.00s</td> <td>_0.0s</td> <td>__0_s</td> <td>___0s</td> </tr> <tr> <td>2</td> <td>2.00s</td> <td>_2.0s</td> <td>__2_s</td> <td>___20s</td> </tr> <tr> <td>1.2</td> <td>1.20s</td> <td>_1.2s</td> <td>Input impossible</td> <td>Input impossible</td> </tr> <tr> <td>1.23</td> <td>1.23s</td> <td>_1.3s^{*2}</td> <td>Input impossible</td> <td>Input impossible</td> </tr> <tr> <td>12</td> <td>2.00s^{*3}</td> <td>12.0s</td> <td>_12_s</td> <td>_120s</td> </tr> <tr> <td>12.3</td> <td>2.30s^{*4}</td> <td>12.3s</td> <td>Input impossible</td> <td>Input impossible</td> </tr> <tr> <td>123</td> <td>3.00s^{*5}</td> <td>23.0s^{*4}</td> <td>123_s</td> <td>1230s</td> </tr> </tbody> </table> <p data-bbox="408 813 1243 1193"> *1 A decimal point cannot be entered in Mode 2 and 3. *2 Since Mode 1 allows display of only the first decimal place, the decimal value “2” that was first entered is overwritten. *3 Since Mode 0 allows display of a single-digit number to the left of the decimal point, the “1” that was first entered is overwritten. *4 Since the cursor does not move to the right of the decimal point until a decimal point is entered, the “1” that was first entered is overwritten. *5 Since the cursor does not move to the right of the decimal point until a decimal point is entered, the “1” and “2” that were first entered are overwritten. </p> <ul data-bbox="385 1219 584 1248" style="list-style-type: none"> <li data-bbox="385 1219 584 1248">• When Disabled <p data-bbox="408 1253 1243 1350">You can enter any 4-digit value including a decimal point (the decimal point counts as a digit), regardless of the decimal point position. The entered value is displayed more precisely.</p> <p data-bbox="408 1356 1243 1416">When the Data Display accepts inputs, the cursor position starts on the far right position.</p> <table border="1" data-bbox="408 1435 911 1754"> <thead> <tr> <th>Input value</th> <th>Displayed value</th> <th>Mode</th> </tr> </thead> <tbody> <tr> <td>0</td> <td>0.00s</td> <td>0</td> </tr> <tr> <td>0.0</td> <td>0.00s</td> <td>0</td> </tr> <tr> <td>1</td> <td>1.00s</td> <td>0</td> </tr> <tr> <td>1.2</td> <td>1.20s</td> <td>0</td> </tr> <tr> <td>1.23</td> <td>1.23s</td> <td>0</td> </tr> <tr> <td>12</td> <td>12.0s</td> <td>1</td> </tr> <tr> <td>12.3</td> <td>12.3s</td> <td>1</td> </tr> <tr> <td>123</td> <td>123_s</td> <td>2</td> </tr> <tr> <td>1230</td> <td>1230s</td> <td>3</td> </tr> <tr> <td>1234</td> <td>Input impossible</td> <td>—</td> </tr> </tbody> </table>	Input value	Value displayed on Data Display				Mode0 (0.01s)	Mode1 (0.1s)	Mode2 (1s) ^{*1}	Mode3 (10s) ^{*1}	0	0.00s	_0.0s	__0_s	___0s	2	2.00s	_2.0s	__2_s	___20s	1.2	1.20s	_1.2s	Input impossible	Input impossible	1.23	1.23s	_1.3s ^{*2}	Input impossible	Input impossible	12	2.00s ^{*3}	12.0s	_12_s	_120s	12.3	2.30s ^{*4}	12.3s	Input impossible	Input impossible	123	3.00s ^{*5}	23.0s ^{*4}	123_s	1230s	Input value	Displayed value	Mode	0	0.00s	0	0.0	0.00s	0	1	1.00s	0	1.2	1.20s	0	1.23	1.23s	0	12	12.0s	1	12.3	12.3s	1	123	123_s	2	1230	1230s	3	1234	Input impossible	—
Input value	Value displayed on Data Display																																																																													
	Mode0 (0.01s)	Mode1 (0.1s)	Mode2 (1s) ^{*1}	Mode3 (10s) ^{*1}																																																																										
0	0.00s	_0.0s	__0_s	___0s																																																																										
2	2.00s	_2.0s	__2_s	___20s																																																																										
1.2	1.20s	_1.2s	Input impossible	Input impossible																																																																										
1.23	1.23s	_1.3s ^{*2}	Input impossible	Input impossible																																																																										
12	2.00s ^{*3}	12.0s	_12_s	_120s																																																																										
12.3	2.30s ^{*4}	12.3s	Input impossible	Input impossible																																																																										
123	3.00s ^{*5}	23.0s ^{*4}	123_s	1230s																																																																										
Input value	Displayed value	Mode																																																																												
0	0.00s	0																																																																												
0.0	0.00s	0																																																																												
1	1.00s	0																																																																												
1.2	1.20s	0																																																																												
1.23	1.23s	0																																																																												
12	12.0s	1																																																																												
12.3	12.3s	1																																																																												
123	123_s	2																																																																												
1230	1230s	3																																																																												
1234	Input impossible	—																																																																												

■ Alarm/Color Settings/Basic

Settings for the Numeric Display's color and numeric data.

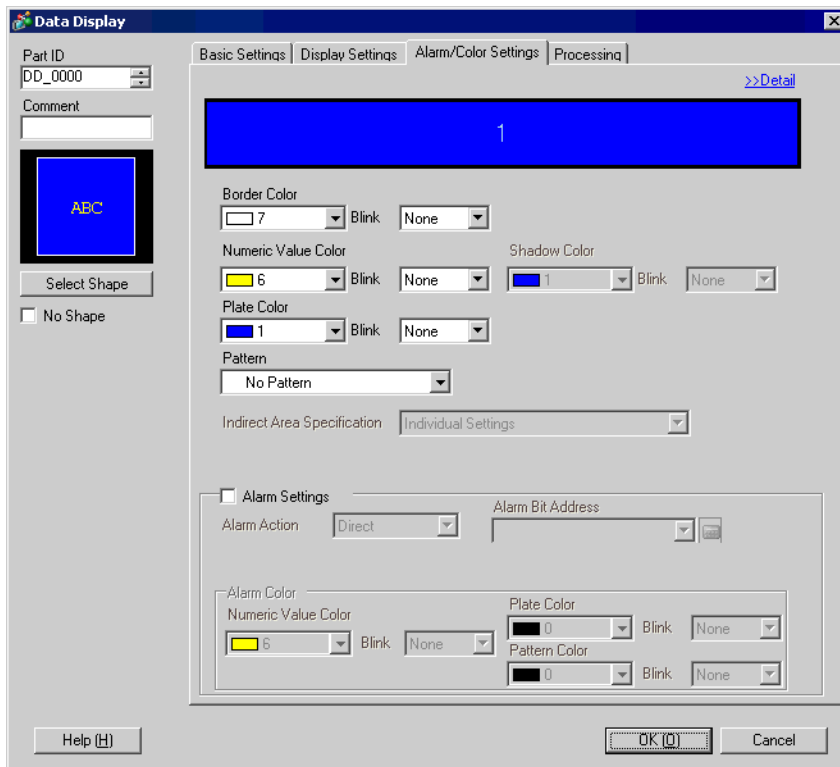

Setting	Description
Border Color	Select the border color for the Numeric Display.
Numeric Value Color	Set the color for the Numeric Display's numeric data.
Shadow Color	Set the background color for the Numeric Display's numeric value. NOTE <ul style="list-style-type: none"> This can only be set when [Shadow] is set on the [Text Attribute] in the [Display Settings] tab's [Font Settings].
Plate Color	Set a background color for the Numeric Display part.
Pattern	Set a background pattern for the Numeric Display.
Pattern Color	Set a pattern color for the Numeric Display.
Blink	You can choose different blink settings for the [Border Color], [Numeric Value Color], [Shadow Color], [Plate Color], and [Pattern Color]. NOTE <ul style="list-style-type: none"> There are cases where you can and cannot set Blink depending on the Main Unit and System Settings' [Color Settings]. "9.5.1 Setting Colors ■ List of Available Colors" (page 9-34)

Continued

Setting	Description								
Indirect Area Specification	<p>If the [Alarm Settings]'s [Alarm Action] is [Address], choose the designation method for the word addresses which will store the alarm's upper/lower limit value.</p> <ul style="list-style-type: none"> • Area After Display Address The lower→upper limit values are automatically allocated to consecutive addresses in order starting from the [Monitor Word Address] designated in the [Basic Settings] tab. <table border="1" data-bbox="632 442 1094 571"> <tr> <td>Monitor Word Address</td> <td>Display Data</td> </tr> <tr> <td>+1</td> <td>Lower Limit Value</td> </tr> <tr> <td>+2</td> <td>Upper Limit Value</td> </tr> <tr> <td></td> <td>:</td> </tr> </table> <p>e.g.) When [Monitor Word Address] is "D100" The Lower Limit Value will be "D101", and the Upper Limit Value will be "D102".</p> <ul style="list-style-type: none"> • Individual Settings The [Min Value] and [Max Value] will be separately set to a word address. 	Monitor Word Address	Display Data	+1	Lower Limit Value	+2	Upper Limit Value		:
Monitor Word Address	Display Data								
+1	Lower Limit Value								
+2	Upper Limit Value								
	:								
Alarm Settings	<p>The color can be set to change when the value goes outside of a specified range. Select whether or not to designate [Alarm Settings].</p> <p>NOTE</p> <ul style="list-style-type: none"> • The alarm settings can only be set when the number of ranges is one. When the number of ranges is one, the contents of the Basic screen will also be displayed on the Detail screen. • On the [Basic Settings] tab, when you select [Input Permit], you cannot input a value outside the warning range. 								
Alarm Action	<p>Choose the Alarm Action.</p> <ul style="list-style-type: none"> • Direct Write a set constant as the Alarm Settings' upper/lower limit value. • Address Designate the address where the Upper/Lower Limit values are stored. • Change Color When the [Alarm Bit Address] turns ON, the color changes and an alarm displays. 								
Alarm Bit Address	<p>When the [Alarm Action] is [Change Color], input the bit address which will act as a trigger for the color change. When this bit turns ON, the color change will occur.</p>								

Continued

Setting		Description																																										
Alarm Settings	Alarm Range Upper Limit/ Lower Limit	<p>If [Alarm Action] is [Direct], you can set a upper/lower limit value for the alarm range.</p> <p>If [Alarm Action] is [Address] and [Individual Settings] is selected, specify the Word Address where the upper/lower limit value will be stored.</p> <p>Each [Data Type] and [Sign +/-] has a different size range.</p> <table border="1"> <thead> <tr> <th>Data Type</th> <th>Data Length</th> <th>Sign +/-</th> <th>Alarm Range Settings</th> </tr> </thead> <tbody> <tr> <td rowspan="4">Dec</td> <td rowspan="2">16 Bit</td> <td>Unchecked</td> <td>0 to 65535</td> </tr> <tr> <td>Checked</td> <td>-32,768 to 32,767</td> </tr> <tr> <td rowspan="2">32 bit</td> <td>Unchecked</td> <td>0 to 4294967295</td> </tr> <tr> <td>Checked</td> <td>-2147483648 to 2147483647</td> </tr> <tr> <td rowspan="2">Bin</td> <td>16 Bit</td> <td colspan="2" rowspan="2">0000..0000 (16 bit) to 1111..1111 (16 bit)</td> </tr> <tr> <td>32 bit</td> </tr> <tr> <td rowspan="2">BCD</td> <td>16 Bit</td> <td colspan="2">0 to 9999</td> </tr> <tr> <td>32 bit</td> <td colspan="2">0 to 99999999</td> </tr> <tr> <td rowspan="2">Hex</td> <td>16 Bit</td> <td colspan="2">0 to FFFF(h)</td> </tr> <tr> <td>32 bit</td> <td colspan="2">0 to FFFFFFFF(h)</td> </tr> <tr> <td>Oct</td> <td>16 bit only</td> <td colspan="2">0 to 177777(o)</td> </tr> <tr> <td>Float</td> <td>32 bit only</td> <td colspan="2">-9.9e16 to 9.9e16</td> </tr> </tbody> </table>	Data Type	Data Length	Sign +/-	Alarm Range Settings	Dec	16 Bit	Unchecked	0 to 65535	Checked	-32,768 to 32,767	32 bit	Unchecked	0 to 4294967295	Checked	-2147483648 to 2147483647	Bin	16 Bit	0000..0000 (16 bit) to 1111..1111 (16 bit)		32 bit	BCD	16 Bit	0 to 9999		32 bit	0 to 99999999		Hex	16 Bit	0 to FFFF(h)		32 bit	0 to FFFFFFFF(h)		Oct	16 bit only	0 to 177777(o)		Float	32 bit only	-9.9e16 to 9.9e16	
	Data Type	Data Length	Sign +/-	Alarm Range Settings																																								
	Dec	16 Bit	Unchecked	0 to 65535																																								
			Checked	-32,768 to 32,767																																								
		32 bit	Unchecked	0 to 4294967295																																								
			Checked	-2147483648 to 2147483647																																								
	Bin	16 Bit	0000..0000 (16 bit) to 1111..1111 (16 bit)																																									
		32 bit																																										
	BCD	16 Bit	0 to 9999																																									
		32 bit	0 to 99999999																																									
Hex	16 Bit	0 to FFFF(h)																																										
	32 bit	0 to FFFFFFFF(h)																																										
Oct	16 bit only	0 to 177777(o)																																										
Float	32 bit only	-9.9e16 to 9.9e16																																										
Alarm Color	Sets the alarm color.																																											
Numeric Value Color	Select an alarm display color for numeric values from among 256 colors.																																											
Plate Color	Select an alarm display background color for numeric values from among 256 colors.																																											
Pattern Color	Select an alarm display pattern color for numeric values from among 256 colors.																																											
Blink	<p>Select whether or not the Part will blink, and the blink speed. You can choose different blink settings for the [Numeric Value Color], [Plate Color], and [Pattern Color].</p> <p>NOTE</p> <ul style="list-style-type: none"> There are cases where you can and cannot set Blink depending on the Main Unit and System Settings' [Color Settings]. <p> "9.5.1 Setting Colors ■ List of Available Colors" (page 9-34)</p>																																											

■ Alarm/Color Settings/Detail

The displayed color will change depending on the numeric data's range.

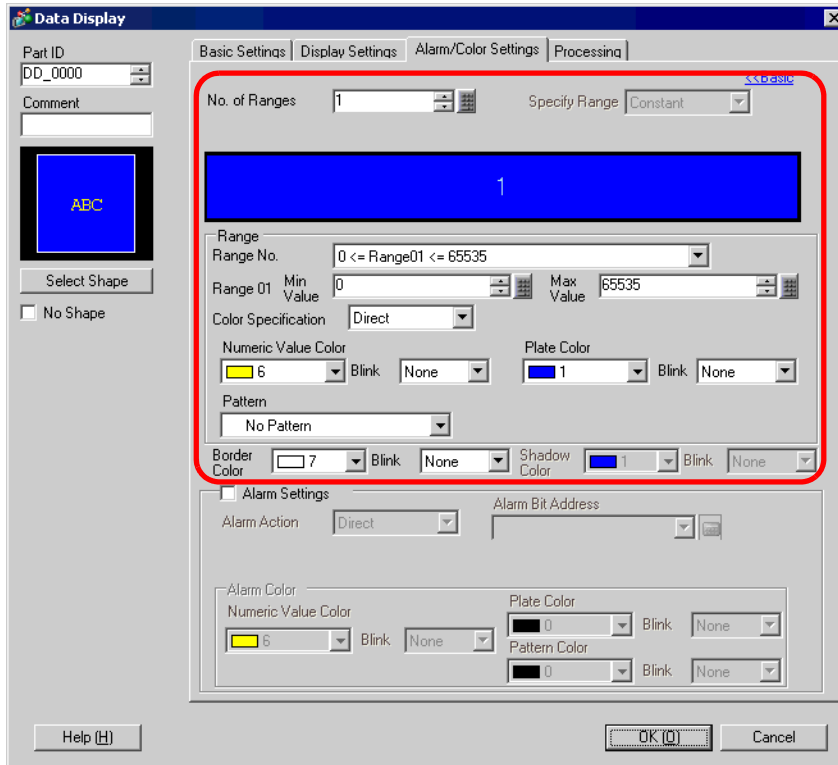

Setting	Description								
No. of Ranges	Set the number of ranges to be color-coded for the numeric display from 1 to 16.								
Specify Range	<p>If the [No. of Ranges] is 2 or greater, choose how each range's min and max value will be specified. If there is only 1 range, it will be fixed as [Constant].</p> <ul style="list-style-type: none"> Constant Designate a set constant as the Min/Max value. (Direct Specification) Address Designate the address where the Min/Max values are stored. (Indirect Specification) 								
Indirect Area Specification	<p>If the [Specify Range] is [Address], choose the designation method for the word addresses which will store the range's min/max value.</p> <ul style="list-style-type: none"> Area After Display Address The lower→upper limit values are automatically allocated to consecutive addresses in order starting from the [Monitor Word Address] designated in the [Basic Settings] tab. <table border="1" style="margin-left: 40px;"> <tr> <td>Monitor Word Address</td> <td>Display Data</td> </tr> <tr> <td>+1</td> <td>Lower Limit Value</td> </tr> <tr> <td>+2</td> <td>Upper Limit Value</td> </tr> <tr> <td></td> <td>⋮</td> </tr> </table> <p>e.g.) If the [Monitor Word Address] is "D100", the Min Value will be "D101", and the Max Value will be "D102".</p> <ul style="list-style-type: none"> Individual Settings The [Min Value] and [Max Value] will be separately set to a word address. 	Monitor Word Address	Display Data	+1	Lower Limit Value	+2	Upper Limit Value		⋮
Monitor Word Address	Display Data								
+1	Lower Limit Value								
+2	Upper Limit Value								
	⋮								

Continued

Setting		Description																																							
Range	Range No.	Choose a range from 1 to 16 from among the ranges set in [Range No.] by the Upper/Lower Limit value and color. The values set in [Max Value] and [Min Value] will also be displayed. e.g.) Lower Limit Value ≤ Range ** < Upper Limit Value																																							
	Min Value/ Max Value	Set the Upper/Lower Limit values for the range specified in [Range No]. If [Specify Range] is [Constant], input a upper/lower limit value. If [Address] is set, specify the address where the upper/lower limit value will be stored. Each [Data Type] and [Sign +/-] setting on the [Basic Settings] tab has a different size range. <table border="1" style="margin-left: 20px;"> <thead> <tr> <th colspan="2">Data Type</th> <th>Sign +/-</th> <th>Range</th> </tr> </thead> <tbody> <tr> <td rowspan="5">16 Bit</td> <td rowspan="2">Dec</td> <td>Unchecked</td> <td>0 to 65535</td> </tr> <tr> <td>Checked</td> <td>-32,768 to 32,767</td> </tr> <tr> <td>Hex</td> <td>—</td> <td>0 to FFFF(h)</td> </tr> <tr> <td>Oct</td> <td>—</td> <td>0 to 177777(o)</td> </tr> <tr> <td>Bin</td> <td>—</td> <td>0 to FFFF(h)</td> </tr> <tr> <td>BCD</td> <td>—</td> <td>0 to 9999</td> </tr> <tr> <td rowspan="5">32 bit</td> <td rowspan="2">Dec</td> <td>Unchecked</td> <td>0 to 4294967295</td> </tr> <tr> <td>Checked</td> <td>-2147483648 to 2147483647</td> </tr> <tr> <td>Hex</td> <td>—</td> <td>0 to FFFFFFFF(h)</td> </tr> <tr> <td>Bin</td> <td>—</td> <td>0 to FFFFFFFF(h)</td> </tr> <tr> <td>BCD</td> <td>—</td> <td>0 to 99999999</td> </tr> <tr> <td>Float</td> <td>—</td> <td>-9.9e¹⁶ to 9.9e¹⁶</td> </tr> </tbody> </table>	Data Type		Sign +/-	Range	16 Bit	Dec	Unchecked	0 to 65535	Checked	-32,768 to 32,767	Hex	—	0 to FFFF(h)	Oct	—	0 to 177777(o)	Bin	—	0 to FFFF(h)	BCD	—	0 to 9999	32 bit	Dec	Unchecked	0 to 4294967295	Checked	-2147483648 to 2147483647	Hex	—	0 to FFFFFFFF(h)	Bin	—	0 to FFFFFFFF(h)	BCD	—	0 to 99999999	Float	—
Data Type		Sign +/-	Range																																						
16 Bit	Dec	Unchecked	0 to 65535																																						
		Checked	-32,768 to 32,767																																						
	Hex	—	0 to FFFF(h)																																						
	Oct	—	0 to 177777(o)																																						
	Bin	—	0 to FFFF(h)																																						
BCD	—	0 to 9999																																							
32 bit	Dec	Unchecked	0 to 4294967295																																						
		Checked	-2147483648 to 2147483647																																						
	Hex	—	0 to FFFFFFFF(h)																																						
	Bin	—	0 to FFFFFFFF(h)																																						
	BCD	—	0 to 99999999																																						
Float	—	-9.9e ¹⁶ to 9.9e ¹⁶																																							
Color Specification	Select the set range's color and pattern designation method. If the [No. of Ranges] is 2 or greater or [Color Stack] is set, this will be fixed as [Direct]. <ul style="list-style-type: none"> • Direct The [Display Color], [Pattern], and [Pattern Color] of the range specified in [Range No.] will be directly chosen and set. (Direct Specification) • Address Specify the address where the color code will be stored. (Indirect Specification) 																																								
Numeric Value Color	Set the color for the Numeric Display's numeric data.																																								
Plate Color	Set a background color for the Numeric Display part.																																								
Pattern	Set a background pattern for the Numeric Display.																																								
Pattern Color	Set a pattern color for the Numeric Display.																																								
Border Color	Select the border color for the Numeric Display.																																								
Shadow Color	Set a shadow color for the Numeric Display's text.																																								
Blink	Select whether or not the Part will blink, and the blink speed. You can choose different blink settings for the [Numeric Value Color], [Plate Color], [Pattern Color], [Border Color], and [Shadow Color]. <div style="border: 1px solid black; padding: 2px; width: fit-content; margin: 5px 0;">NOTE</div> <ul style="list-style-type: none"> • There are cases where you can and cannot set Blink depending on the Main Unit and System Settings' [Color Settings]. "9.5.1 Setting Colors ■ List of Available Colors" (page 9-34) 																																								

■ Processing

You can perform an arithmetic operation on the data read from the device/PLC, and display the resulting data.

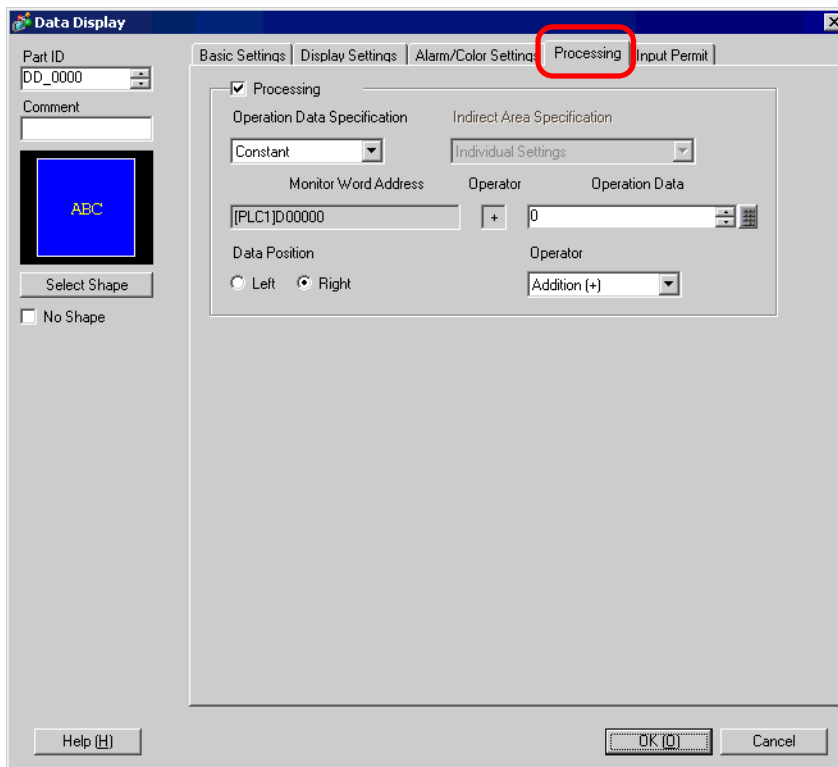

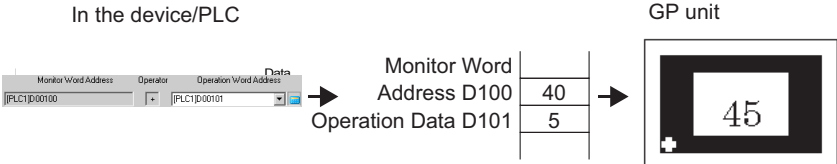

Setting	Description
Processing	<p>Set whether or not to perform an arithmetic operation on the data stored in [Monitor Word Address] and display the result.</p> <p>NOTE</p> <ul style="list-style-type: none"> • In the following cases, [Processing] can not be set: <ul style="list-style-type: none"> • When [Specify Input/Display Range] is set. • When [Alarm Settings] are set.
Operation Data Specification	<p>Select the method to set the data to operate.</p> <ul style="list-style-type: none"> • Constant Write a set constant as the data to operate. (Direct Specification) • Address Designate the address which stores the data to operate. (Indirect Specification)

Continued

	Setting	Description																																				
Processing	Indirect Area Specification	<p>If the [Operation Data Specification] is [Address], choose the designation method for the address which will store the data to operate.</p> <ul style="list-style-type: none"> • Area After Display Address <p>Arithmetic operations take place using the values stored in the [Monitor Word Address], and the address that follows. e.g.) When [Operation Data Specification] is [Address], [Indirect Area Specification] is [Area After Display Address], [Operator] is “+”.</p> <div style="text-align: center;"> <p>In the device/PLC</p>  </div> <ul style="list-style-type: none"> • Individual Settings Select a separate Word Address for the operation data. 																																				
	Monitor Word Address	The [Monitor Word Address] specified on the [Basic Settings] tab is displayed.																																				
	Operation Data	<p>For [Word Address] data, set the other data. If the [Operation Data Specification] is set to [Constant], enter the operation data here. Each [Data Type] on the [Basic Settings] tab has a different size range. If [Address] is set, specify the address where the operation data will be stored.</p> <table border="1" data-bbox="419 981 1177 1379"> <thead> <tr> <th colspan="2">Data Type</th> <th>Sign +/-</th> <th>Range</th> </tr> </thead> <tbody> <tr> <td rowspan="5">16 Bit</td> <td rowspan="2">Dec</td> <td>Unchecked</td> <td>0 to 65535</td> </tr> <tr> <td>Checked</td> <td>-32768 to 32767</td> </tr> <tr> <td>Hex</td> <td>—</td> <td>0 to FFFF(h)</td> </tr> <tr> <td>Oct</td> <td>—</td> <td>0 to 177777(o)</td> </tr> <tr> <td>Bin</td> <td>—</td> <td>0 to FFFF(h)</td> </tr> <tr> <td rowspan="5">32 bit</td> <td rowspan="2">Dec</td> <td>Unchecked</td> <td>0 to 4294967295</td> </tr> <tr> <td>Checked</td> <td>-2147483648 to 2147483647</td> </tr> <tr> <td>Hex</td> <td>—</td> <td>0 to FFFFFFFF(h)</td> </tr> <tr> <td>Bin</td> <td>—</td> <td>0 to FFFFFFFF(h)</td> </tr> <tr> <td>BCD</td> <td>—</td> <td>0 to 99999999</td> </tr> <tr> <td>Float</td> <td>—</td> <td>-9.9e¹⁶ to 9.9e¹⁶</td> </tr> </tbody> </table>	Data Type		Sign +/-	Range	16 Bit	Dec	Unchecked	0 to 65535	Checked	-32768 to 32767	Hex	—	0 to FFFF(h)	Oct	—	0 to 177777(o)	Bin	—	0 to FFFF(h)	32 bit	Dec	Unchecked	0 to 4294967295	Checked	-2147483648 to 2147483647	Hex	—	0 to FFFFFFFF(h)	Bin	—	0 to FFFFFFFF(h)	BCD	—	0 to 99999999	Float	—
Data Type		Sign +/-	Range																																			
16 Bit	Dec	Unchecked	0 to 65535																																			
		Checked	-32768 to 32767																																			
	Hex	—	0 to FFFF(h)																																			
	Oct	—	0 to 177777(o)																																			
	Bin	—	0 to FFFF(h)																																			
32 bit	Dec	Unchecked	0 to 4294967295																																			
		Checked	-2147483648 to 2147483647																																			
	Hex	—	0 to FFFFFFFF(h)																																			
	Bin	—	0 to FFFFFFFF(h)																																			
	BCD	—	0 to 99999999																																			
Float	—	-9.9e ¹⁶ to 9.9e ¹⁶																																				

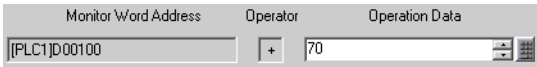
Continued

Setting		Description
Processing	Data Position	<p>Select the Operation Data's or Operation Word Address' display position from [Right] or [Left].</p> <p>Right: The Monitor Word Address is left, the Operation Data or Operation Word Address is right</p>  <p>Left: The Operation Data or Operation Word Address is left, the Monitor Word Address is right</p> 
	Operator	<p>Choose an operator from [Addition (+)], [Subtraction (-)], [Mult. (*)], [Division (/)], [Logical AND (&)], [Logical OR ()], or [Exclusive OR (^)].</p> <p>NOTE</p> <ul style="list-style-type: none"> When the data format for a calculation is 32 bit Float, only addition, subtraction, multiplication and division can be performed.

NOTE

- Any overflowing digits resulting from an arithmetic operation will be ignored. e.g.) When [16 Bit Hex] is set, the result of “FFFF(h) + 1(h)” would be “0000(h)”.
- If division produces a remainder, an error may occur as a result of rounding the decimal.
- Results of base address + offset value calculations are always handled as 16 bit Bin values, regardless of the data length and data format settings. If a calculation result exceeds 16 bits (exceeds 65,535), bit 0 to bit 15 are handled as the valid bits, and higher-order bits are discarded.

14.11.2 Text Display

■ Basic Settings/Basic

Display string data stored in a specified word address in a device/PLC.

☞ “14.3 Displaying/Inputting Text Data” (page 14-8)

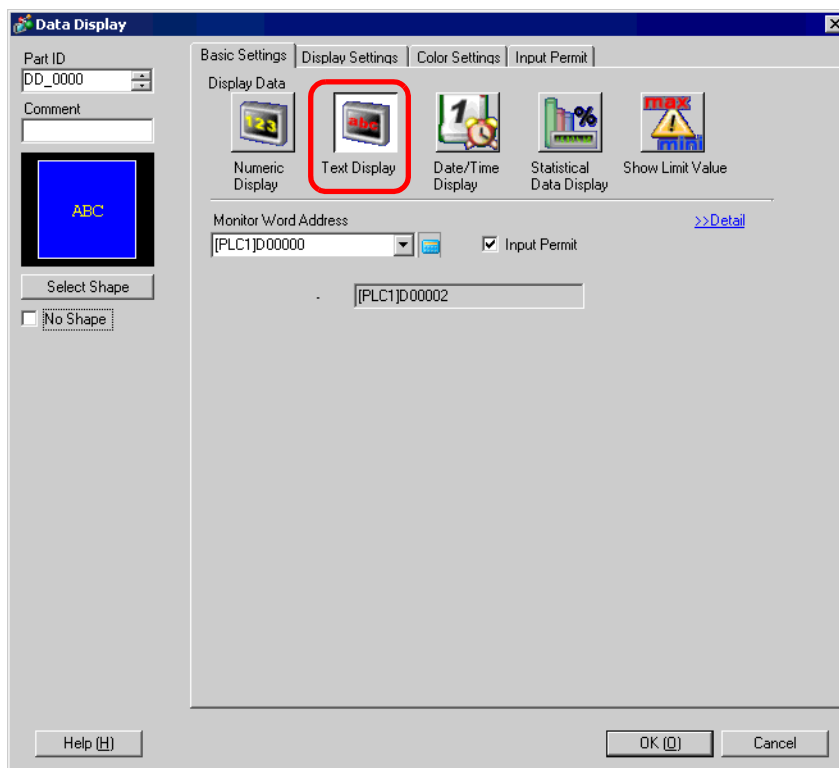

Setting	Description
Monitor Word Address	The data stored in this word address will be displayed in real-time as text. NOTE <ul style="list-style-type: none"> The relationship of high order and low order word data will differ according to the device/PLC type.
Input Permit	Set whether keypad and barcode reader input will be accepted by the Text Display.
Monitor Word Address' Last Address Display	Displays the address of Monitor Word Address + No. of Used Word Addresses (changes by the No. of Display Characters). e.g.) When the [Display Settings] tab's [No. of Display Char.] is "5" and the [Monitor Word Address] is "D100", the last address will become "D102".

■ Basic Settings/Detail

You can indirectly specify an address for the Text Display, or set up an update condition for displayed text.

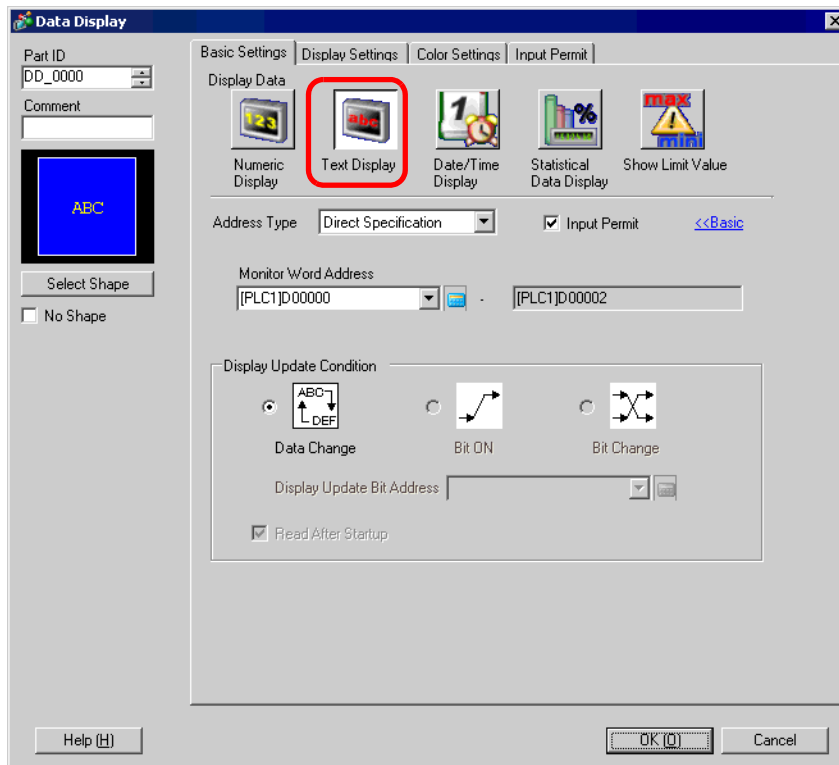

Setting	Description
Address Type	Select how you want to define the display address (Monitor Address): [Direct Specification], [Address], or [Device Type & Address].
Input Permit	You can accept inputs from a keypad, bar code reader, or a two-dimensional bar code reader. Select this check box to display the [Input Permit] tab.
Monitor Word Address	You can have a real-time numeric display of data stored in the word address specified here. To indirectly specify the Monitor Word Address, in the [Address Type] list select [Address] or [Device Type & Address].
Address	Indirectly designates to the device specified in [Base Address].

Continued

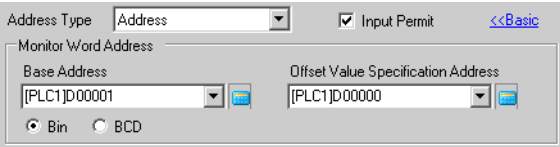
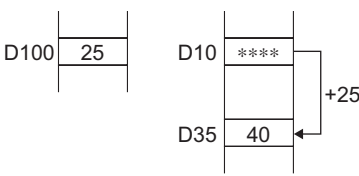
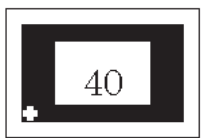
Setting		Description
Monitor Word Address	Address	<div style="text-align: center;">  </div> <p>The [Base Address] becomes the standard indirectly designated address. In [Offset Value Specification Address], set the address that stores the offset value from the [Base Address]. Example: When you indirectly specify [Monitor Word Address] D35 [Base Address] = D10 [Offset Value Specification Address] = D100 The data in [Offset Value Specification Address] is handled as the off-set value from the [Base Address].</p>
		<div style="display: flex; justify-content: space-around; align-items: center;"> <div style="text-align: center;"> <p>In the device/PLC</p>  </div> <div style="text-align: center;"> <p>GP unit</p>  </div> </div> <p>The [Base Address] (D10) is added to the [Offset Value Specification Address] (D100)'s data, which is "25", for a resulting address of D35 with the data "40".</p>
		<p>IMPORTANT</p> <ul style="list-style-type: none"> If the [Base Address] + [Offset Value] operation results in overflowing digits (more than 16-bit), the correct Monitor Word Address cannot be requested. In this case the Monitor Word Address will be undefined.
	Bin, BCD	Choose the type of data stored in the [Offset Value Specification Address] from [Bin] or [BCD].
Device Type & Address		Indirectly designates both the device and address.
Device/PLC		When [Address Type] is [Device Type & Address], select which device/PLC's address to indirectly designate.

Continued

Setting		Description
Monitor Word Address	Device Type & Address	<div data-bbox="546 200 1108 349" data-label="Image"> </div> <p>Input the start address of the Word Address to specify the Display Address in [Device Specification Start Address]. Store the Address Mode in [Device Specification Start Address]. Address Mode is the mode to determine if the Device Address is for Internal or External (PLC) Device. Store the Device Code and the Address Code in the three words following [Device Specification Start Address]. The Word Address specified with the Device Code and the Address Code will be displayed.</p> <p>Example: When you indirectly specify [Monitor Word Address] CN35 [Device Specification Start Address] = D100 [Address Mode] = External (PLC) Device [Device Code] = CN: 0061</p> <div data-bbox="463 768 1177 969" data-label="Diagram"> </div> <p>*1 Address Mode 0: External (PLC) Device 1: Internal Device In the above case, 0 is stored.</p> <p>*2 Please see the "GP-Pro EX Device/PLC Connection Manual" for device codes. If you select an internal device, the device codes are LS area: 0000 and USR area: 0001.</p> <p>The address designated by D100, D101, D102, and D103 is CN35. Its data, "40", is displayed.</p> <div data-bbox="404 1238 495 1277" data-label="Section-Header"> <p>NOTE</p> </div> <ul style="list-style-type: none"> • If the indirectly-designated address is out of range or does not exist, a communication error will occur. An error can affect the screen update. When an error occurs, check the indirectly-designated data and write the correct value to the device/PLC's address to restore the screen update.

Continued

Setting	Description
Display Update Condition	<p>Designate the condition which will update the display. This can only be set on the Detail screen.</p> <ul style="list-style-type: none"> • Data Change The display is updated when a change occurs in the data stored in the [Monitor Word Address] on the [Basic Settings] tab. • Bit ON The display is updated when a bit stored in the [Monitor Word Address] on the [Basic Settings] tab turns ON. • Bit Change The display is updated when a bit stored in the [Monitor Word Address] on the [Basic Settings] tab changes state from ON to OFF or from OFF to ON.
Display Update Bit Address	<p>Defines the ON/OFF trigger bit address for when [Display Update Condition] is set to [Bit ON] or [Bit Change].</p>
Read After Startup	<p>When the text data has a large volume or many Text Display parts are set on the single screen, select this check box for each Text Display to increase other tags' display speeds. However, when this is checked, Text Display speeds will decrease.</p>

NOTE

- After the data has been changed in the monitor address, please change the [Display Update Bit Address] so the text displays. If the changing order is reversed, the text may not display properly.
- If the [Display Update Bit Address] changes immediately after the text data changes in the device/PLC, there may be instances where the text does not display correctly. In this case, program the device/PLC to use the send wait to slightly delay the trigger bit change.
The send wait period depends on the amount of placed parts, scan time, baud rate, and the number of characters used.

■ Input Permit/Basic

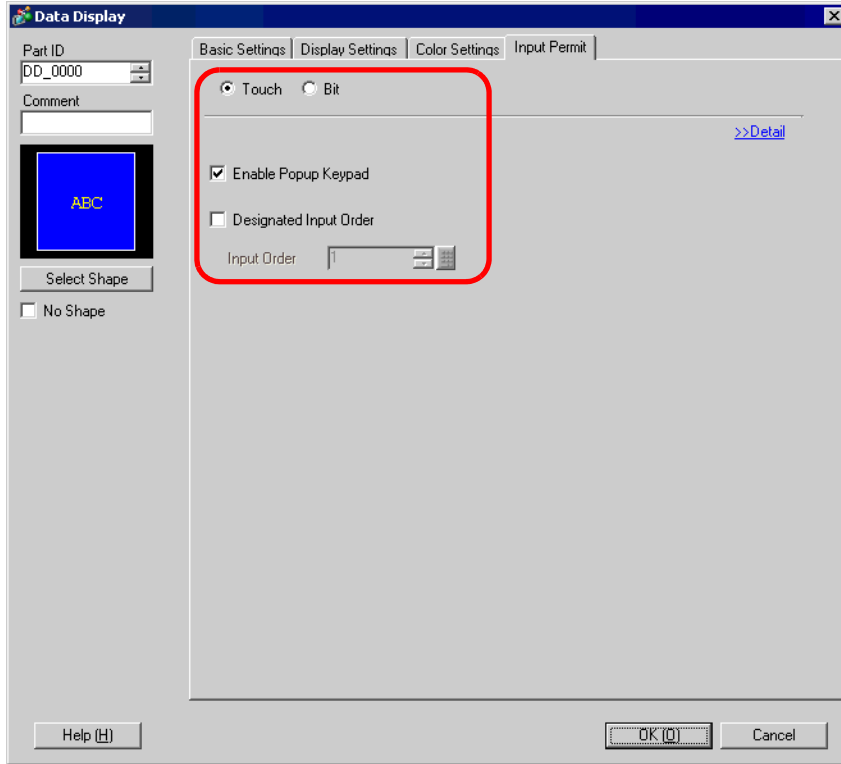

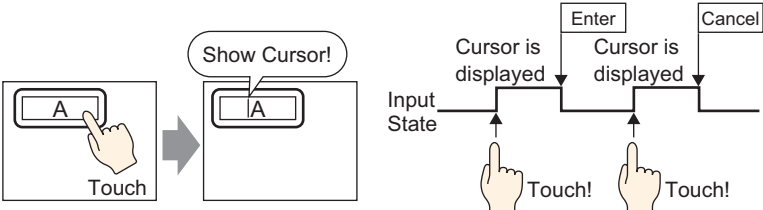
Setting	Description
Input Permit Methods	<p>Select the method which will make the Data Display go into the input state (cursor display state).</p> <ul style="list-style-type: none"> • Touch Touch the Data Display and it goes into the Input Permit state. 

Continued

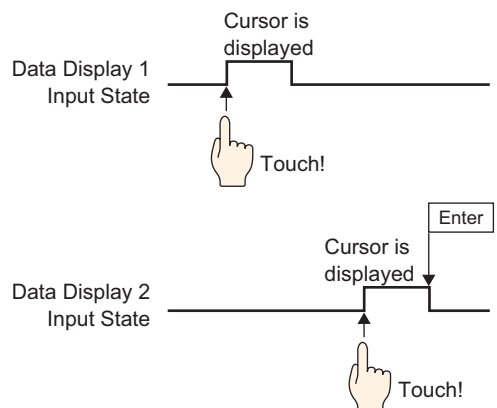
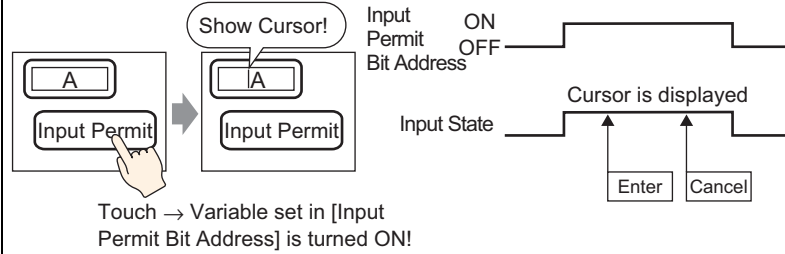
Setting	Description
<p>Input Permit Methods</p>	<p>NOTE</p> <ul style="list-style-type: none"> If you touch a Data Display while inputting data into another Data Display, the inputted data will revert to its previous data, and the most recently touched part will enter the Input Permit state.  <p>Touch Data Display 1 and without deciding touch Data Display 2 and...</p> <ul style="list-style-type: none"> Bit When the Input Permit Bit Address is ON, the Data Display is in the Input Permit state.  <p>Touch → Variable set in [Input Permit Bit Address] is turned ON!</p> <p>NOTE</p> <ul style="list-style-type: none"> If the [Input Permit Bit Address] turns OFF while inputting data in a Data Display, the Input Permit state is cancelled, and the input data is erased.

Continued

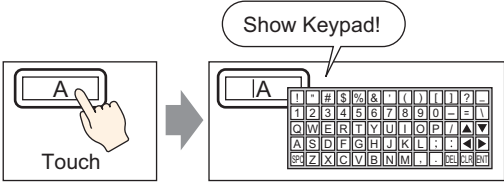
Setting	Description
Touch	
Enable Popup Keypad	<p>Select whether or not a popup keypad will display when you touch the Data Display part.</p>  <p>NOTE</p> <ul style="list-style-type: none"> A popup keypad cannot be used when the Data Display is placed on a Window screen.
Designated Input Order	<p>When you will be inputting into multiple Data Displays in sequence, select the order in which they will enter the input state.</p>
Input Order	<p>Select the order, from 1 to 384, in which the Part will enter the input state.</p>

Continued

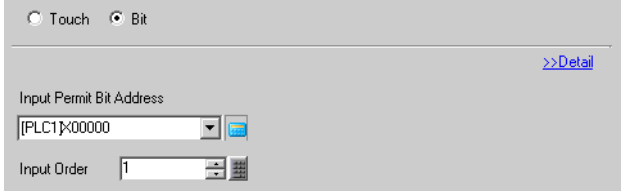
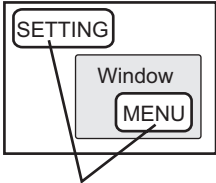
Setting	Description
Bit	
	<p>Input Permit Bit Address</p> <p>When the bit address set here turns ON, the Data Display enters the input state.</p>
	<p>Input Order</p> <p>Select the order from 1 to 384 that the Part will enter the Input Permit state if multiple [Input Permit Bit Addresses] turn ON at the same time (when a bit address has been registered to multiple Data Display parts, or when different bit addresses turn ON at the same time).</p> <p>NOTE</p> <ul style="list-style-type: none"> • If more than one [Input Permit Bit Address] is turned ON at the same time, the Data Displays will enter the input state according to their [Input Order] settings. If the [Input Order] settings are the same, the input state order will be determined by the order the parts were placed. • If the [Input Permit Bit Address] of Data Displays placed on the Base Screen and Window Screen turn ON at the same time, the Base Screen will have a higher priority for the input state than the Window Screen. When placing Data Displays on both the Base and Window screen, make sure to set a different [Input Permit Bit Address]. <div data-bbox="669 1128 883 1309" style="text-align: center;">  </div> <p style="text-align: center;">Multiple [Input Permit Bit Addresses] turn ON simultaneously</p>

■ Input Permit/Details

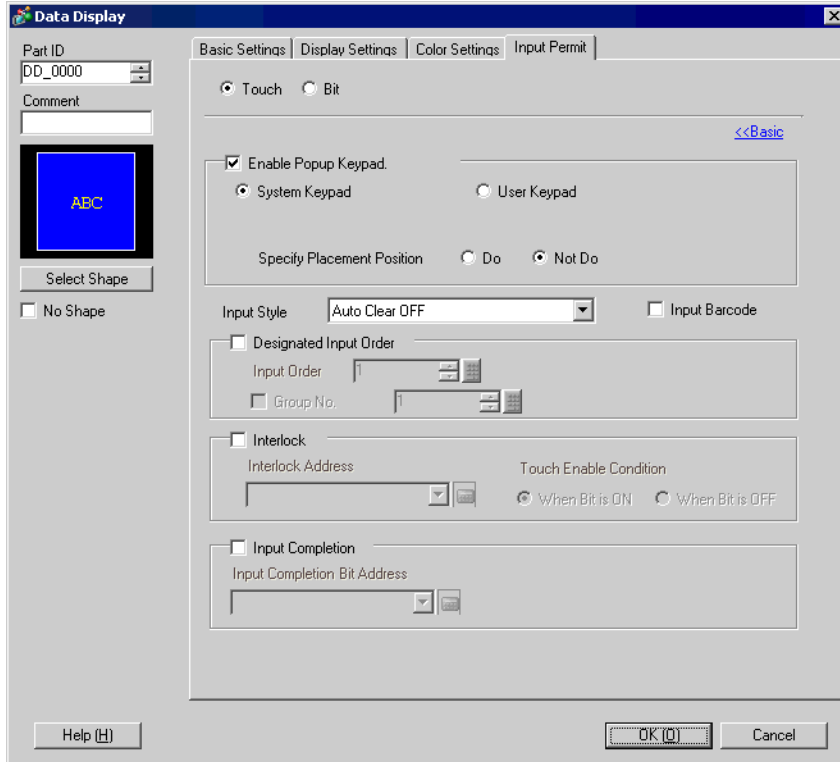

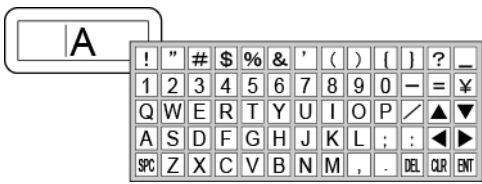
Setting		Description
Touch	Enable Popup Keypad	Select whether or not a popup keypad will display when you touch the Data Display part. NOTE <ul style="list-style-type: none"> A popup keypad cannot be used when the Data Display is placed on a Window screen.
	Keypad Type	<ul style="list-style-type: none"> System Keypad Use a standard keypad pre-set by GP-Pro EX. This is the typically used keypad. User Keypad Create a user-defined keypad with the Keypad part. This keypad allows for customized input. ☞ "16.5.1 Keypad Settings Guide ■ User Keypad" (page 16-22)
	System Keypad	GP-Pro EXThe standard keypad provided by GP-Pro EX is displayed. 

Continued

Setting		Description													
Touch	User Keypad	Keypad No.													
	Specify Placement Position														
	Designated Input Order														
	Input Order														
	Group No.														
	Interlock														
	Interlock Address														
Touch Enable Condition															
		<p>Set the number of the custom-made keypad. ☞ “16.5.1 Keypad Settings Guide ■ User Keypad” (page 16-22)</p> <p>Select whether or not to set the popup keypad’s display position. If [Do] is selected, the popup keypad’s Display Area can be selected and moved after the Data Display part is positioned.</p> <p>NOTE</p> <ul style="list-style-type: none"> If the Data Display is grouped with other objects, you cannot select or move the popup keypad’s Display Area. <p>When you will be inputting into multiple Data Displays in sequence, select the order in which they will enter the input state.</p> <p>Select the order, from 1 to 384, in which the Part will enter the input state.</p> <p>Divide the Data Displays into groups for continuous data input. The cursor will move in turn to each successive Data Display registered in the same group, according to the input order, setting them into the Input Permit state. The Group No. can be from 1 to 10. ☞ “14.13.2 Set Input Order by Group” (page 14-107)</p> <p>This function only allows input when a bit designated via [Interlock Address] is in a state that has been selected via [Touch Enable Condition]. Select whether or not to use the Interlock function. ☞ “14.7 Preventing Operational Errors (Interlock)” (page 14-26)</p> <p>Select the bit address that will designate the enable condition, to allow input to be entered. This address’ state will determine if touch is enabled or disabled.</p> <p>Select the condition that will enable the part to be touched, to allow input to be entered.</p> <table border="1"> <thead> <tr> <th>Touch Enable Condition</th> <th>Interlock Address Status</th> <th>Touch Enabled/ Disabled</th> </tr> </thead> <tbody> <tr> <td rowspan="2">When Bit is ON</td> <td>ON</td> <td>Touch enabled</td> </tr> <tr> <td>OFF</td> <td>Touch disabled</td> </tr> <tr> <td rowspan="2">When Bit is OFF</td> <td>ON</td> <td>Touch disabled</td> </tr> <tr> <td>OFF</td> <td>Touch enabled</td> </tr> </tbody> </table> <p>NOTE</p> <ul style="list-style-type: none"> When Interlock’s [Touch Enable Condition] is disabled while you are inputting, the Data Display will remain in the Input Permit state. Interlock will not work until the input is completed. 	Touch Enable Condition	Interlock Address Status	Touch Enabled/ Disabled	When Bit is ON	ON	Touch enabled	OFF	Touch disabled	When Bit is OFF	ON	Touch disabled	OFF	Touch enabled
Touch Enable Condition	Interlock Address Status	Touch Enabled/ Disabled													
When Bit is ON	ON	Touch enabled													
	OFF	Touch disabled													
When Bit is OFF	ON	Touch disabled													
	OFF	Touch enabled													

Continued

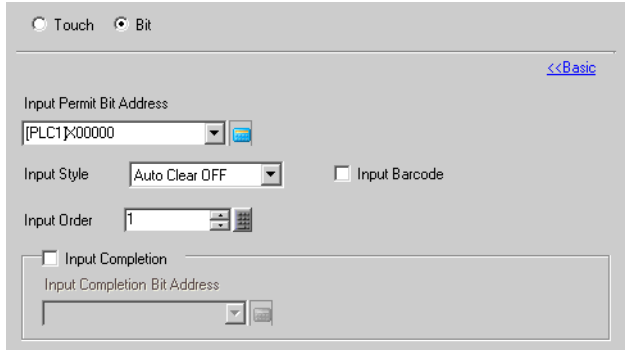
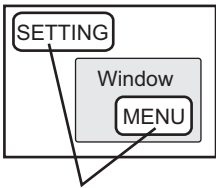
Setting	Description
	
Bit	<p>Input Permit Bit Address</p> <p>When the bit address set here turns ON, the Data Display enters the input state.</p>
Input Order	<p>Select the order from 1 to 384 that the Part will enter the Input Permit state if multiple [Input Permit Bit Addresses] turn ON at the same time (when a bit address has been registered to multiple Data Display parts, or when different bit addresses turn ON at the same time).</p> <p>NOTE</p> <ul style="list-style-type: none"> • If more than one [Input Permit Bit Address] is turned ON at the same time, the Data Displays will enter the input state according to their [Input Order] settings. If the [Input Order] settings are the same, the input state order will be determined by the order the parts were placed. • If the [Input Permit Bit Address] of Data Displays placed on the Base Screen and Window Screen turn ON at the same time, the Base Screen will have a higher priority for the input state than the Window Screen. When placing Data Displays on both the Base and Window screen, make sure to set a different [Input Permit Bit Address].  <p>Multiple [Input Permit Bit Addresses] turn ON simultaneously</p>

Continued

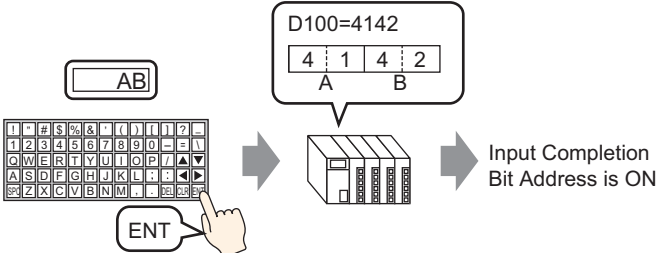
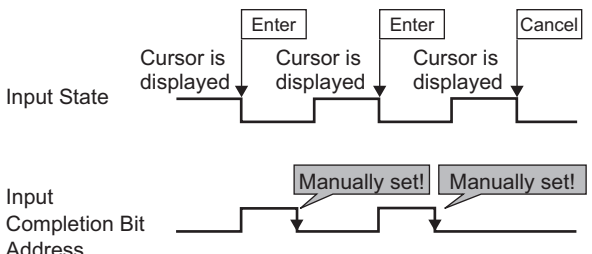
Setting	Description
Input Style	<ul style="list-style-type: none"> • Auto Clear OFF New text data will build on previously inputted data. Pressing [CLR] on the keypad clears the value. • Auto Clear ON The first key pressed (except move cursor, [ENT], [DEL], or [BS]) will clear the previously inputted text data. • Auto Clear ON + Input Check When using barcode input, check whether the number of inputted digits coincide with the [No. of Display Char.]. If they do not coincide, the data will not be written to the word address.
Input Barcode	<p>A setting that allows input from a barcode reader.  "8.2.2 Setup Procedure" (page 8-5)</p>
Input Completion	<p>Detects and notifies you when input has been completed.</p> 
Input Completion Bit Address	<p>Sets the bit address that will turn ON when input has been completed.</p>  <p>NOTE</p> <ul style="list-style-type: none"> • Please return this bit to OFF after input has been completed.

■ Display Settings

Set the Text Display's font and attributes.

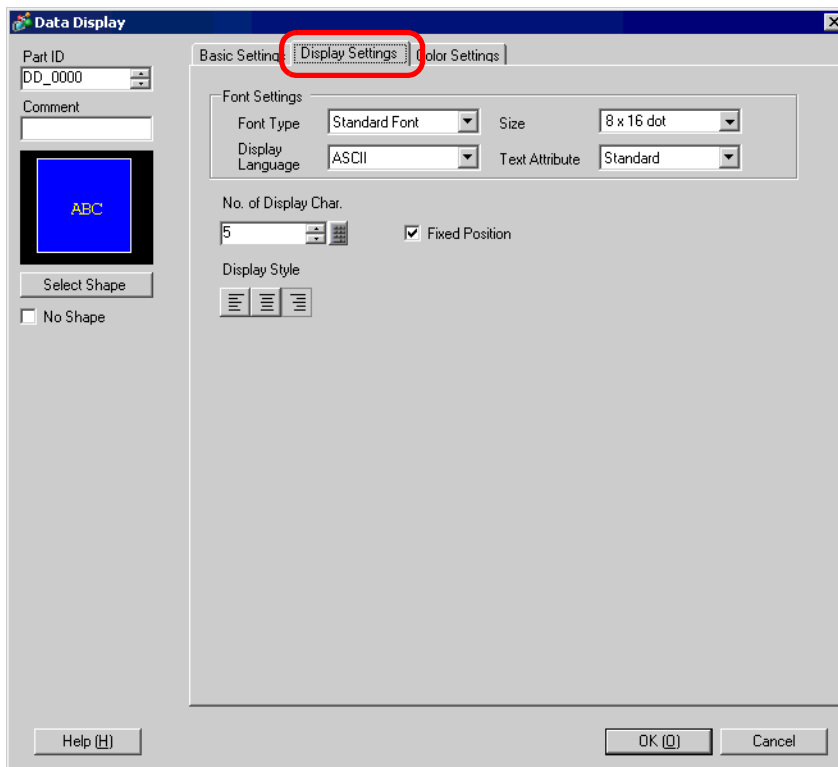

Setting	Description
Font Settings	Set a font for the text.
Font Type	Choose a font type for the text from [Standard Font] or [Stroke Font].
Size	Choose a font size for the text. Standard Font: (8 to 64) × (8 to 128) Standard Font (Fixed Size): [6 × 10], [8 × 13], [13 × 23] Stroke Font: Select from 6 to 127.
Display Language	Select the display language: [Japanese], [Western], [Chinese (Simplified)], [Chinese (Traditional)], [Korean], [Cyrillic], or [Thai].
Text Attribute	Select the font's text attributes. Standard Font: Choose from [Standard], [Bold], [Shadow] Standard Font (Fixed Size): Choose from [Standard], [Shadow] Stroke Font: Choose from [Standard], [Bold], [Outline]
No. of Display Char.	Set the number of characters to be displayed from 1 to 100.
Fixed Position	Set whether or not the text will be fixed in the center of the Part.
Display Style	Select the alignment of the text display area's text: [Align Right], [Align Left], or [Align Center].

■ Color Settings/Basic

Select the Text Display's color.

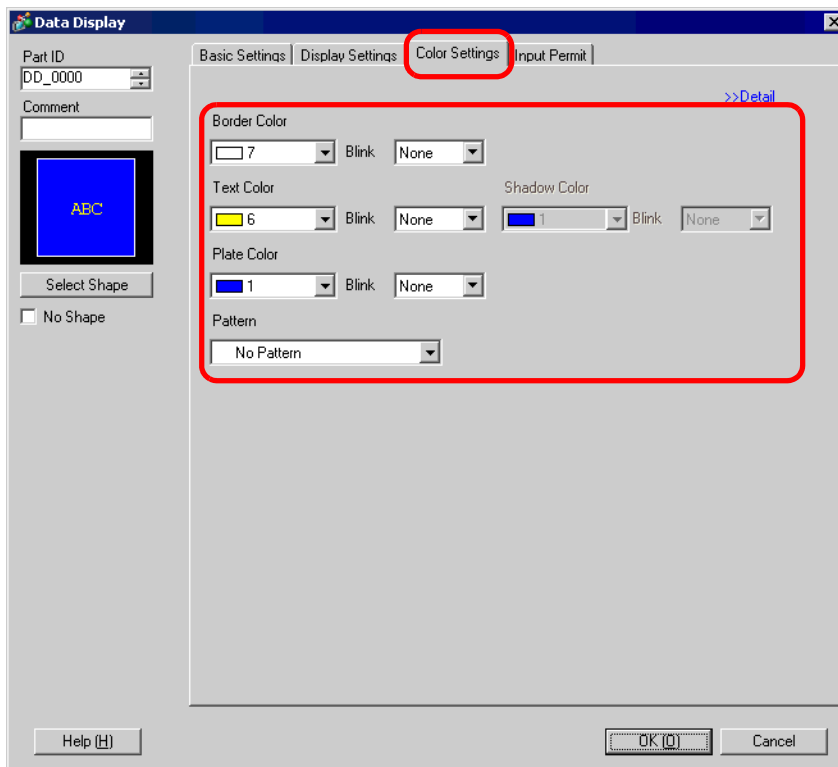

Setting	Description
Border Color	Select a color for the Text Display's border.
Text Color	Select a color for the Text Display's text.
Shadow Color	Select a color for the Text Display's text background.
Plate Color	Select a color for the Text Display's background.
Pattern	Select a background pattern for the Text Display.
Pattern Color	Select a color for the Text Display's background pattern.
Blink	<p>Select whether or not the Part will blink, and the blink speed. You can choose different blink settings for the [Border Color], [Text Color], [Shadow Color], [Plate Color], and [Pattern Color].</p> <p>NOTE</p> <ul style="list-style-type: none"> There are cases where you can and cannot set Blink depending on the Main Unit and System Settings' [Color Settings]. <p> "9.5.1 Setting Colors ■ List of Available Colors" (page 9-34)</p>

■ Color Settings/Detail

Select how the text data's color changes when the bit turns ON.

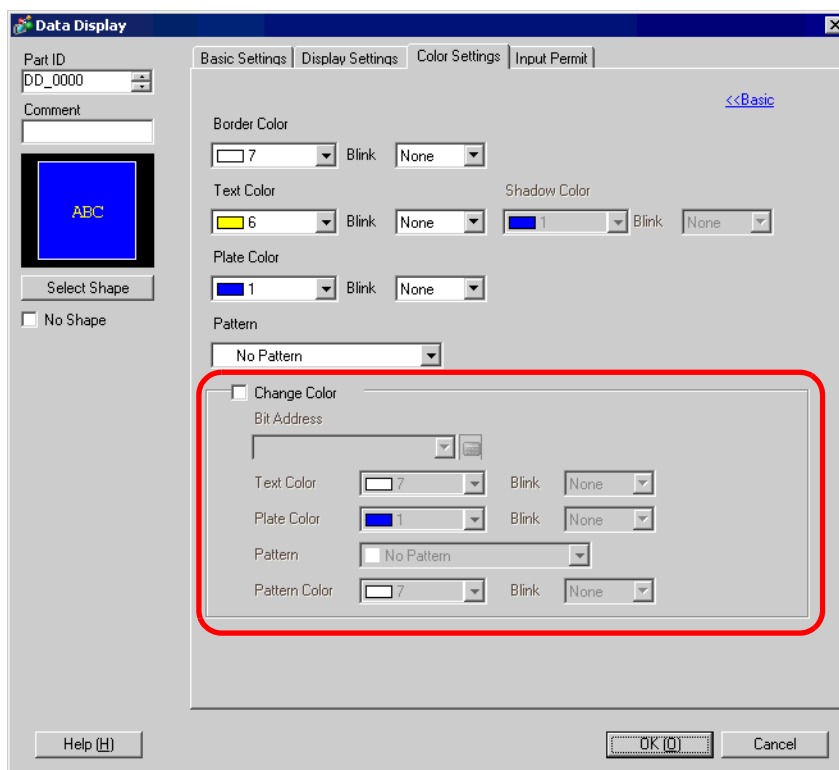

Setting	Description
Change Color	Select whether or not a different color will be displayed when the designated [Bit Address] turns ON.
Bit Address	When the address set here turns ON, the color change will occur.
Text Color	When the [Bit Address] turns ON, this text color will be displayed.
Plate Color	When the [Bit Address] turns ON, this background color will be displayed.
Pattern	Select a background pattern for the Text Display.
Pattern Color	Select a color for the Text Display's background pattern.
Blink	Select whether or not the Part will blink, and the blink speed. You can choose different blink settings for the [Text Color], [Plate Color], and [Pattern Color]. <div style="border: 1px solid black; padding: 2px; display: inline-block; margin-top: 5px;">NOTE</div> <ul style="list-style-type: none"> • There are cases where you can and cannot set Blink depending on the Main Unit and System Settings' [Color Settings]. <p>☞ "9.5.1 Setting Colors ■ List of Available Colors" (page 9-34)</p>

14.11.3 Date/Time Display

■ Basic Settings

Displays the current date and time.

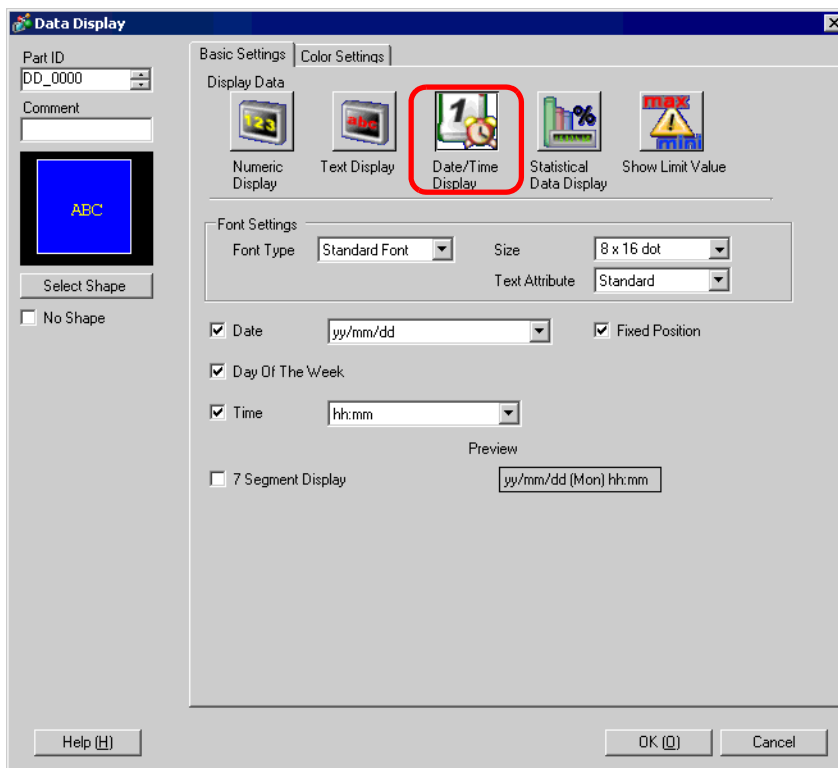

Setting	Description
Font Settings	Set a font for the date/time.
Font Type	Choose a font type for the date/time from [Standard Font] or [Stroke Font].
Size	Choose a font size for the date/time. Standard Font: (8 to 64) × (8 to 128) Standard Font (Fixed Size): [6 × 10], [8 × 13], [13 × 23] Stroke Font: Select from 6 to 127.
Text Attribute	Select the font's text attributes. Standard Font: Choose from [Standard], [Bold], [Shadow] Standard Font (Fixed Size): Choose from [Standard], [Shadow] Stroke Font: Choose from [Standard], [Bold], [Outline] NOTE • If [7 Segment Display] is set, [Text Attribute] cannot be set.

Continued

Setting	Description
Date	<p>Set whether or not to display the date, and select the display format from [yy/mm/dd], [dd/mm/yy], [mm/dd/yy], [20yy/mm/dd], [dd/mm/20yy], or [mm/dd/20yy].</p> <p>NOTE</p> <ul style="list-style-type: none"> When working with a double-byte character language and you select a format that includes the year, month or date, numerals use double-byte characters. However, if you select [7 Segment Display], numerals use single-byte characters.
Day Of The Week	<p>Select whether or not to display the day.</p>
Time	<p>Select whether or not to display the time, and choose the time format from [hh:mm:ss] or [hh:mm].</p> <p>NOTE</p> <ul style="list-style-type: none"> When working with a double-byte character language and you select a format that includes the hours, minutes, or seconds, numerals display as double-byte characters. However, if you select [7 Segment Display], numerals display as single-byte characters.
Fixed Position	<p>Set whether or not the Date/Time Display Area will be fixed in the center of the Part.</p>
7 Segment Display	<p>Data will be displayed using the 7 segment display setting.</p> <p>NOTE</p> <ul style="list-style-type: none"> This cannot be set when [Size] is [Fixed Size]. This can be set only when [Text Attribute] is selected as [Standard].
Preview	<p>Displays the data's image according to the settings.</p>

■ Color Settings

Select the colors for the Date/Time Display on this screen.

☞ “14.6 Displaying the Date and Time” (page 14-23)

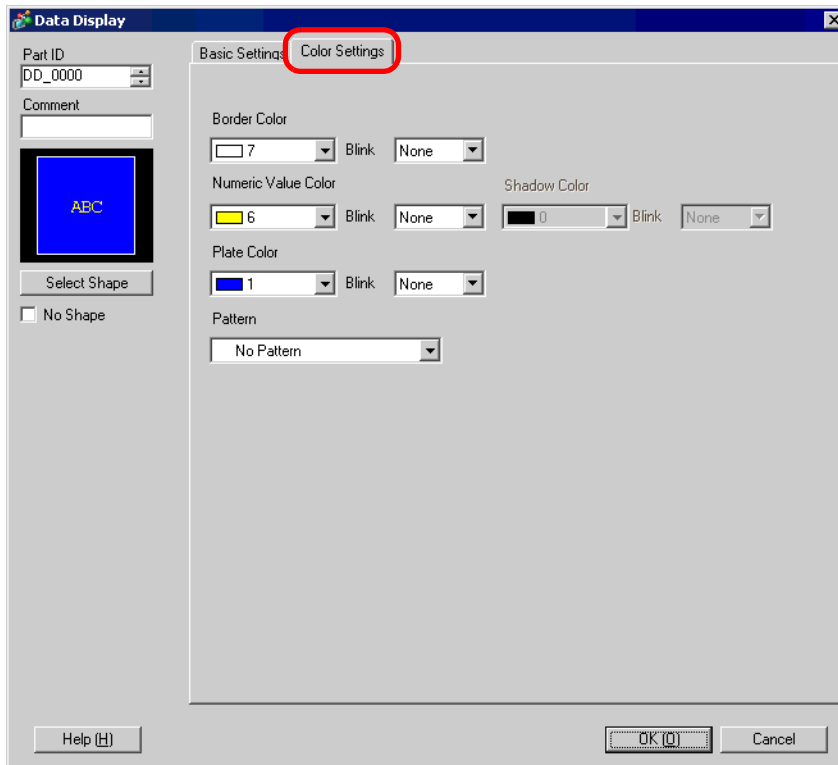

Setting	Description
Border Color	Select a color for the Date/Time Display's border.
Numeric Value Color	Select a color for the Date/Time Display's text.
Shadow Color	Select a shadow color for the Date/Time Display's text.
Plate Color	Select a color for the Date/Time Display's background.
Pattern	Select a background pattern for the Date/Time Display.
Pattern Color	Select a color for the Date/Time Display's pattern.
Blink	<p>Select whether or not the Part will blink, and the blink speed. You can choose different blink settings for the [Border Color], [Numeric Value Color], [Shadow Color], [Plate Color], and [Pattern Color].</p> <p>NOTE</p> <ul style="list-style-type: none"> • There are cases where you can and cannot set Blink depending on the Main Unit and System Settings' [Color Settings]. <p>☞ “9.5.1 Setting Colors ■ List of Available Colors” (page 9-34)</p>

14.11.4 Statistical Data Display

Takes statistics from the values of successive Word Addresses, and displays them in as numeric values. This is mainly used to display statistical graph data set in a Graph. The statistical data settings can be set independently, even without using the Graph's settings.

■ Basic Settings

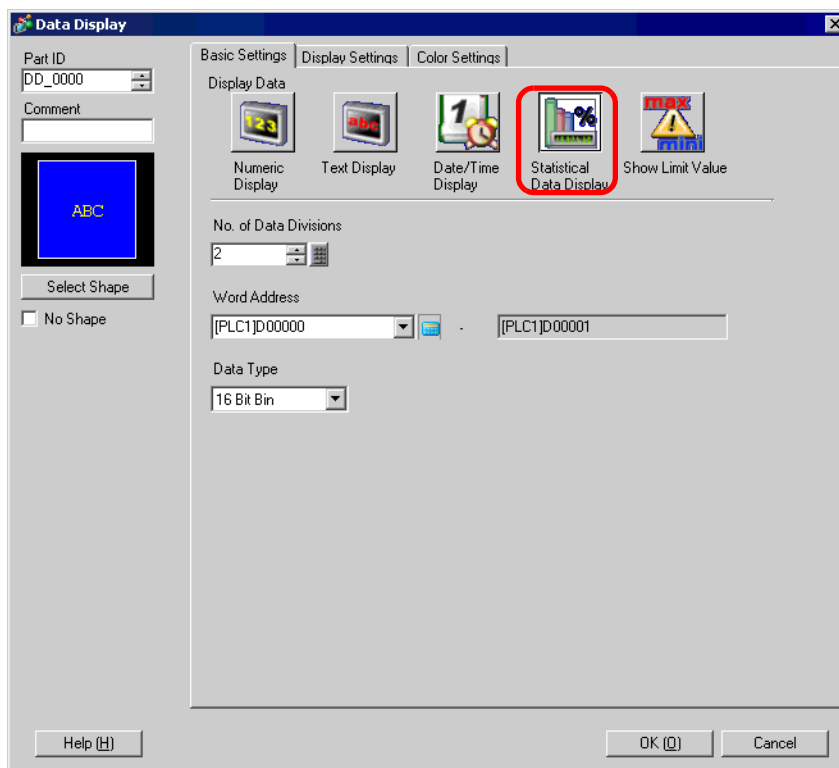

Setting	Description						
No. of Data Divisions	Set the no. of Data shown in the Statistical Data Display. The value can be from 2 to 16.						
Word Address	Set a top word address for the Statistical Data Display. The number of divisions from the specified address can be automatically allotted to the Statistical Data Display. When using a Statistical Graph's Statistical Data Display, the value will be the same as the Statistical Graph's [Monitor Word Address].						
Data Type	<p>Select the type of data to be displayed.</p> <table border="1"> <thead> <tr> <th>Bit Length</th> <th>Data Type</th> </tr> </thead> <tbody> <tr> <td>16 Bit</td> <td>Bin, BCD</td> </tr> <tr> <td>32 bit</td> <td>Bin, BCD, Float</td> </tr> </tbody> </table> <p>NOTE</p> <ul style="list-style-type: none"> Bin, BCD, and Float data can not be mixed on a single Statistical Data Display. 	Bit Length	Data Type	16 Bit	Bin, BCD	32 bit	Bin, BCD, Float
Bit Length	Data Type						
16 Bit	Bin, BCD						
32 bit	Bin, BCD, Float						

■ Display Settings

Set the Statistical Data Display's font and attributes.

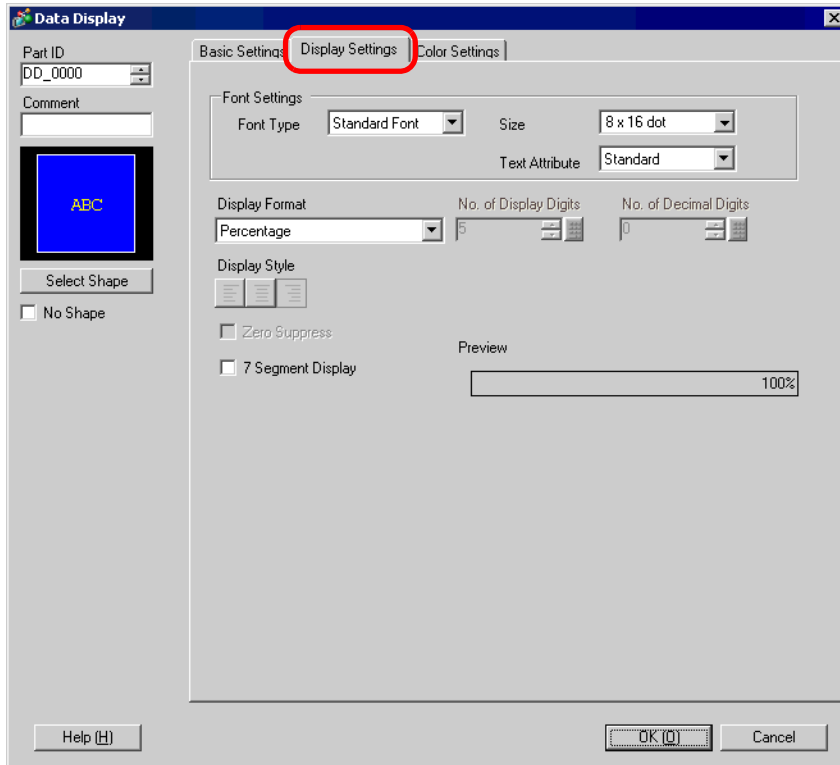

Setting	Description
Font Settings	Set a font for the text.
Font Type	Choose a font type for the statistical data from [Standard Font] or [Stroke Font].
Size	Choose a font size for the statistical data. Standard Font: (8 to 64) × (8 to 128) Standard Font (Fixed Size): [6 × 10], [8 × 13], [13 × 23] Stroke Font: Select from 6 to 127.
Text Attribute	Select the font's text attributes. Standard Font: Choose from [Standard], [Bold], [Shadow] Standard Font (Fixed Size): Choose from [Standard], [Shadow] Stroke Font: Choose from [Standard], [Bold], [Outline] NOTE <ul style="list-style-type: none"> If [7 Segment Display] is set, [Text Attribute] cannot be set.
Display Format	There are three ways of displaying statistical data: [Percentage], [Numeric Value], and [Numeric Value + Percentage]. IMPORTANT <ul style="list-style-type: none"> When [Percentage] has been selected, the division operation may create results that, when totaled, do not add up to exactly 100%.

Continued

Setting	Description																	
No. of Display Digits No. of Decimal Digits	<p>Select the number of digits to display in the numeric display with [No. of Display Digits]. Numbers after the decimal point are included in the display digits. However, the decimal point is not included in the display digits. Each data format has a different size range.</p> <p>Select the number of digits after the decimal point with [No. of Decimal Digits].</p> <p>This can only be set when the [Data Type] is [Dec] or [Float]. Each digit number range is different, depending on the [Data Type].</p> <p>e.g.) When the No. of Display Digits is 5, and the No. of Decimal Digits is 2, the Numeric Display will look as follows.</p> <div style="text-align: center; border: 1px solid black; padding: 5px; width: fit-content; margin: 10px auto;">123.45</div> <table border="1" style="width: 100%; border-collapse: collapse; margin-top: 10px;"> <thead> <tr> <th>Data Length</th> <th>Data Type</th> <th>No. of Display Digits</th> <th>No. of Decimal Digits</th> </tr> </thead> <tbody> <tr> <td rowspan="2" style="text-align: center;">16 Bit</td> <td style="text-align: center;">Bin</td> <td rowspan="2" style="text-align: center;">1 to 11</td> <td rowspan="2" style="text-align: center;">1 to 10</td> </tr> <tr> <td style="text-align: center;">BCD</td> </tr> <tr> <td rowspan="3" style="text-align: center;">32 bit</td> <td style="text-align: center;">Bin</td> <td rowspan="2" style="text-align: center;">1 to 11</td> <td rowspan="2" style="text-align: center;">1 to 10</td> </tr> <tr> <td style="text-align: center;">BCD</td> </tr> <tr> <td style="text-align: center;">Float</td> <td style="text-align: center;">1 to 17</td> <td style="text-align: center;">1 to 16</td> </tr> </tbody> </table>	Data Length	Data Type	No. of Display Digits	No. of Decimal Digits	16 Bit	Bin	1 to 11	1 to 10	BCD	32 bit	Bin	1 to 11	1 to 10	BCD	Float	1 to 17	1 to 16
Data Length	Data Type	No. of Display Digits	No. of Decimal Digits															
16 Bit	Bin	1 to 11	1 to 10															
	BCD																	
32 bit	Bin	1 to 11	1 to 10															
	BCD																	
	Float	1 to 17	1 to 16															
Display Style	There are three ways of positioning statistical data: [Align Right], [Align Left], and [Align Center].																	
Zero Suppress	<p>If this option is selected, leading zeros are not displayed.</p> <p>e.g.) When No. of Display Digits = 4</p> <div style="display: flex; justify-content: space-around; align-items: flex-start;"> <div style="text-align: center;"> <input checked="" type="checkbox"/> Zero Suppress <input style="width: 50px;" type="text" value="25"/> Leading zeroes are not displayed </div> <div style="text-align: center;"> <input type="checkbox"/> Zero Suppress <input style="width: 50px;" type="text" value="0025"/> Zeroes are added to correspond to the length of Display Digits </div> </div>																	
7 Segment Display	<p>Data will be displayed using the 7 segment display setting.</p> <div style="border: 1px solid black; padding: 2px; display: inline-block; margin-bottom: 5px;">NOTE</div> <ul style="list-style-type: none"> This cannot be set when [Size] is [Fixed Size]. This can be set only when [Text Attribute] is selected as [Standard]. 																	
Preview	Displays the data's image according to the settings.																	

■ Color Settings

Select colors for the Statistical Data Display.

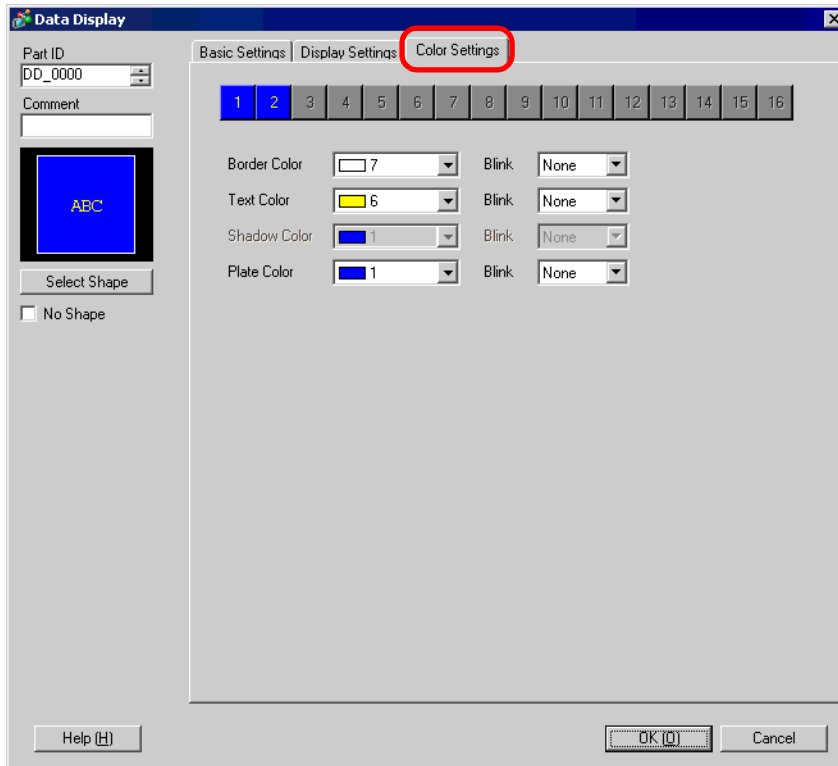

Setting	Description
Select State Bar	Displays the division range number selected in [No. of Data Divisions].
Border Color	Set the border color for the Statistical Display.
Text Color	Set the text color of the Statistical Display.
Shadow Color	Set the shadow color of the Statistical Display.
Plate Color	Select the background color of the Statistical Display.
Blink	<p>Select whether or not the Part will blink, and the blink speed. You can choose different blink settings for the [Border Color], [Text Color], [Shadow Color], and [Plate Color].</p> <p>NOTE</p> <ul style="list-style-type: none"> • There are cases where you can and cannot set Blink depending on the Main Unit and System Settings' [Color Settings]. <p>☞ "9.5.1 Setting Colors ■ List of Available Colors" (page 9-34)</p>

14.11.5 Show Limit Value

Displays the set Alarm values (the displayed data's upper/lower limit values) on the same screen as a Numeric Display part with alarms set.

■ Basic Settings

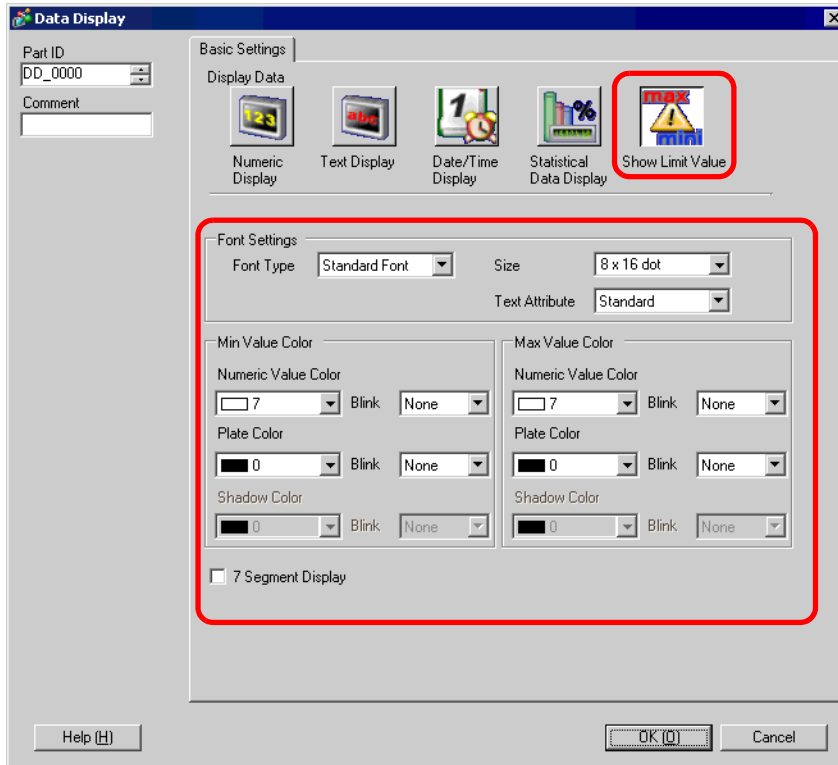

Setting		Description
Font Settings		Set the Limit Value's font.
	Font Type	Choose a font type for the Limit Value from [Stroke Font] or [Bitmap Font].
	Size	Choose a font size for the Limit Value. Standard Font: (8 to 64) × (8 to 128) Standard Font (Fixed Size): [6 × 10], [8 × 13], [13 × 23] Stroke Font: Select from 6 to 127.
	Text Attribute	Select the font's text attributes. Standard Font: Choose from [Standard], [Bold], [Shadow] Standard Font (Fixed Size): Choose from [Standard], [Shadow] Stroke Font: Choose from [Standard], [Bold], [Outline]
Max Value / Min Value Color	Numeric Value Color	Set a color for the min value/max value.
	Plate Color	Set the background color for the max/min value.
	Shadow Color	Set the shadow color for the Limit Value.

Continued

Setting	Description
7 Segment Display	<p>Data will be displayed using the 7 segment display setting.</p> <p>NOTE</p> <ul style="list-style-type: none"> • This cannot be set when [Size] is [Fixed Size]. • This can be set only when [Text Attribute] is selected as [Standard].
Blink	<p>Select whether or not the Part will blink, and the blink speed. You can choose different blink settings for the [Numeric Value Color], [Plate Color], and [Shadow Color].</p> <p>NOTE</p> <ul style="list-style-type: none"> • There are cases where you can and cannot set Blink depending on the Main Unit and System Settings' [Color Settings]. <p>☞ "9.5.1 Setting Colors ■ List of Available Colors" (page 9-34)</p>

- NOTE**
- The input range's (Limit Value's) data type depends on the Numeric Display's data type.
 - If there are no [Alarm Settings] in a Data Display in the Input Permit state or if there is no Data Display part, the value range will be displayed as a blank.

14.12 Restrictions

14.12.1 Text Display Restrictions

- It may take longer to transfer text strings since text is larger than other data types. You can change the text display faster with one of the following procedures:
 - If the text is short, set [Display Update Condition] to [Data Change] and display without using [Display Update Bit Address].
 - If the text is long, select [Bit ON] or [Bit Change], and [Display Update Bit Address].
- A NULL code or No. of Display Char. (no. of bytes) is recognized at the end of a text string.

If the actual number of displayed characters is smaller than the number of characters set in [No. of Display Char.], please store NULL="00(h)" (In Unicode, Null="0000(h)") in the leftover portion of the device/PLC's address. If there is still room left after the NULL, a SPACE ()="20(h)" character will be stored.

e.g.) No. of Display Char. = 6 Actual Number of Displayed Characters ("ERROR") = 5

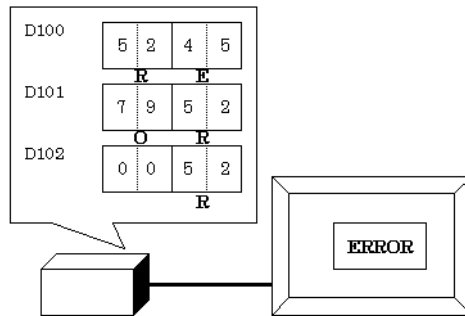

e.g.) No. of Display Char. = 6 Actual Number of Displayed Characters ("STOP") = 4

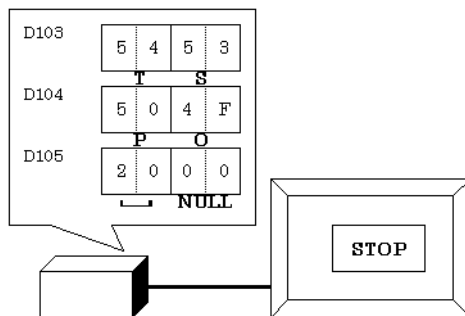

- The relationship of high order and low order word data will differ according to the device/PLC type.

If the text is not displaying correctly, as in the following example, change the character code's store order in the device/PLC.

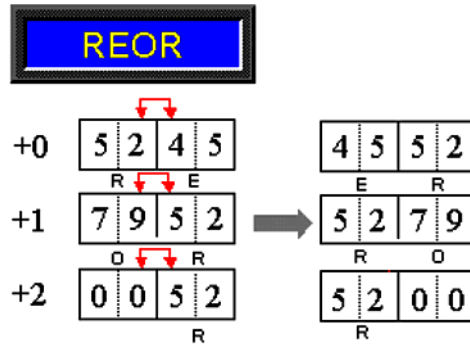

■ Character Input

- If the number of inputted characters is smaller than the [No. of Display Char.], a SPACE ()="20(h)" character will be stored in the remaining portion.

No. of Display Char.= 6 Inputted Characters = 4 (when using a 16-bit device)



No. of Display Char.= 5 Inputted Characters = 4 (when using a 16-bit device)

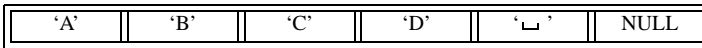

14.12.2 Limitations of Time-Base Function

- If the device specified in the [Basic Settings] workspace's [Monitor Word Address] field is not compatible, the Time-Base function will not work.
- If you select the [Time-Base] check box, you cannot change the following items:

Category	Item	Fixed Value
Basic Settings	Address Type	Direct Specification
	Input/Display Range Definitions	Disable
	Data Type	16 Bit Dec
	Sign +/-	Disable
	Round Off	Disable
Display Settings	No. of Display Digits	3
	No. of Decimal Digits	0
	Display Style	Right Align
	Zero Suppress	Enable
	Zero Display	Enable
	Display Format	Disable
Alarm/Color Settings* ¹	No. of Ranges	1
	Specify Range	Constant
	Range No.	Min Value: 0 Max Value: 999
	Alarm Action	Direct
Processing	Processing	Disable
Input Permit	Input Barcode	Disable

*1 When you select in the [Basic Settings] tab the [Input Permit] check box and in the [Time-Base] group the [Fixed Input] check box is cleared, you cannot change the [Alarm Settings] in the [Alarm/Color Settings] tab.
You can set up the [Alarm Range] with a value from 0 to 999.

- If the mode of the value stored in an address is changed while a value is being input to that address on the GP, the value is input using the previous mode. The mode will not be updated in real time.

14.13 How Data Input Order Works

14.13.1 Set Input Order

After confirming the input in a given Data Display (and pressing the [ENT] key), the Data Display part registered with the next [Input Order] number enters the Input Permit state.

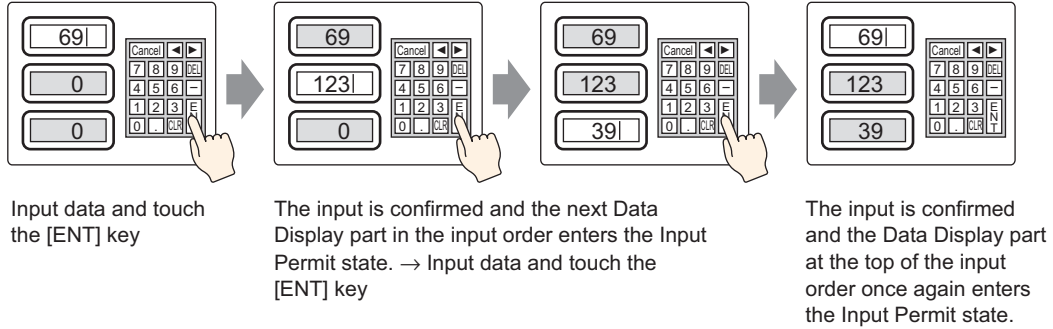

Ending sequential input

For [Touch], when inputting is complete either touch the keypad's [Cancel] key, or touch the currently selected Data Display part a second time. For [Bit], the input is completed by turning OFF the [Input Permit Bit Address].

Sequential input targets

For [Touch], the Data Displays that have a [Designated Input Order] set become targets for sequential inputting.

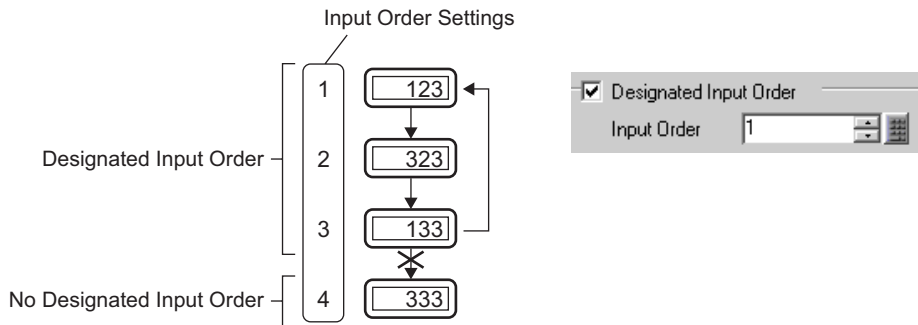

For [Bit], all of the Data Displays have an Input Order setting, but in reality only those with their [Input Permit Bit Address] turned ON will be a target for sequential input.

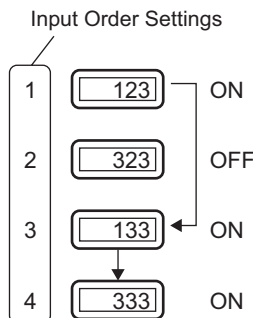

14.13.2 Set Input Order by Group

For [Touch], sequential input Data Displays can be divided up into groups on the Detail screen. Sequential input then takes place inside of each group.

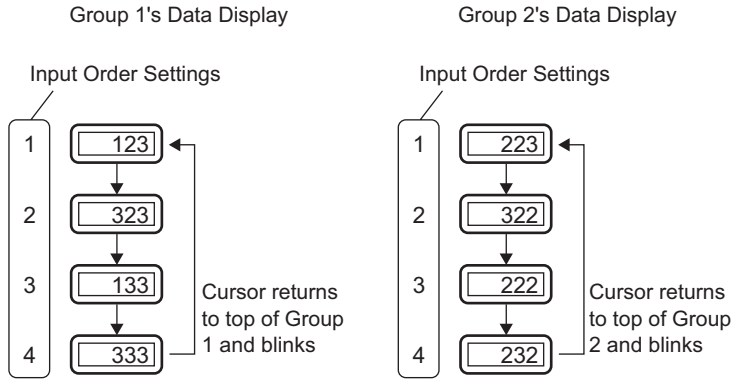

- NOTE**
- If a Data Display in a sequence is Interlocked, that Part is skipped over and the next Data Display in the sequence enters the Input Permit state. The following picture's order would become 1→3→4→1.

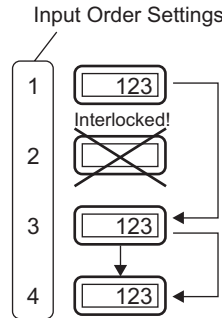

- If you press the [↑][↓] arrow keys while inputting, the current input will be canceled, the previous data will appear, and the next Data Display in the order will enter the Input Permit state (displayed by the cursor).
- In the figure below, when the second Data Display Part of the [Input Order] becomes available for input, you can input data in the following order: 2→3→4→1→2

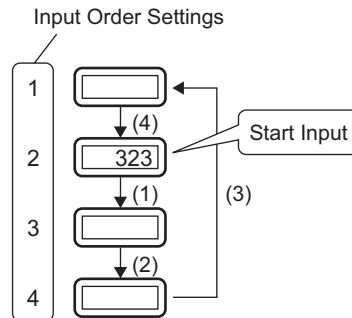

Memo