

19 | Alarm

This chapter explains how to display and manage “Alarms” in GP-Pro EX, and talks about useful features that use Alarms.

Please start by reading “19.1 Settings Menu” (page 19-2) and then turn to the corresponding page.

19.1	Settings Menu	19-2
19.2	Scrolling Alarm Messages.....	19-6
19.3	Viewing Active Alarms in a List	19-13
19.4	Acknowledging the Alarm History	19-19
19.5	Working with Alarm History	19-30
19.6	Displaying Help (Sub Display).....	19-34
19.7	Viewing Alarms by Line	19-49
19.8	Saving the Alarm History to a CF-Card.....	19-56
19.9	Settings Guide.....	19-63
19.10	Restrictions	19-142
19.11	Alarm Feature List.....	19-147

19.1 Settings Menu

Scrolling Alarm Messages

Monitoring Bit Address turns ON and...

Alarm Message

Normal Pressure Abnormal

Alarm Message's scroll direction

Scroll the currently triggered Alarms on all screens.

The alarm recovers and...

Done! Erased! * History does not remain.

- Setup Procedure (page 19-10)
- Details (page 19-6)

Viewing Active Alarms in a List

Monitoring Bit Address turns ON and...

Display alarms

Abnormal Pressure
Abnormal Temp.

Display the currently triggered alarms.

The alarm recovers and...

Abnormal Temp.

Done! Erased! * History does not remain.

- Setup Procedure (page 19-14)
- Details (page 19-13)

Acknowledging the Alarm History

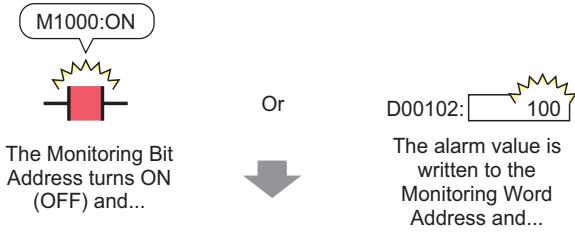

Displays the currently active alarms in the order of their trigger date/time, and the Alarm History of past alarms.

All active Alarms can be viewed in a list.

[Active]

Trigger date	Time	Alarm
08/17	10:09	Abnormal Pressure
08/17	10:10	Abnormal Temp.
08/17	10:21	Low Materials
:	:	:

* The recovered alarm is cleared and no history remains.

Display Alarms separately by Trigger, Acknowledge, and Recovery.

[Log]

08/17	10:09	Abnormal Pressure	10:09	Triggered!
08/17	10:10	Abnormal Pressure	10:10	Acknowledged!
08/17	10:10	Abnormal Temp.		
08/17	10:11	Abnormal Pressure	10:11	Recovered!
:	:	:	:	

* Even when the alarm recovers, the history remains.

Display the Trigger time, Acknowledge time, and Recovery time for all Alarms on the same line.

[History]

Triggered!	Acknowledged!	Recovered!
08/17 10:09	Abnormal Pressure	10:10 10:11
08/17 10:10	Abnormal Temp.	
08/17 10:11	Low Materials	10:11
:	:	:
:	:	:

* Even when the alarm recovers, the history remains.

- ☞ Setup Procedure (page 19-20)
- ☞ Details (page 19-19)

Working with Alarm History

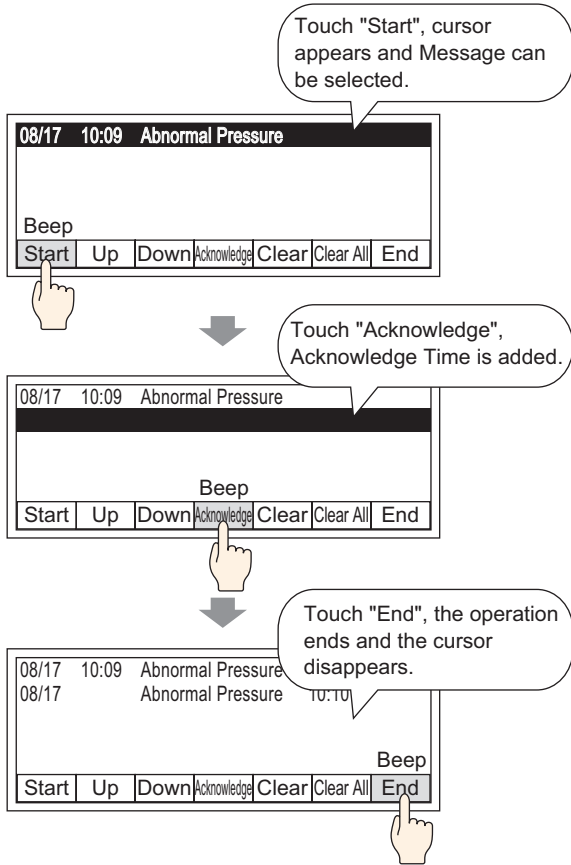

- ☞ Setup Procedure (page 19-31)
- ☞ Details (page 19-30)

Displaying Help (Sub Display)

■ Display a Base Screen (Change Base Screen)

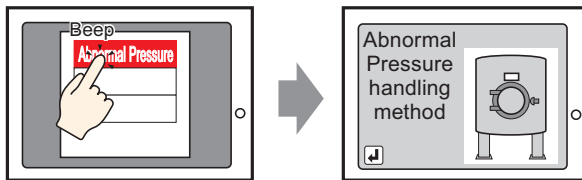

Touch the alarm, and the screen changes to another screen.

■ Display a window (Show Text Window)

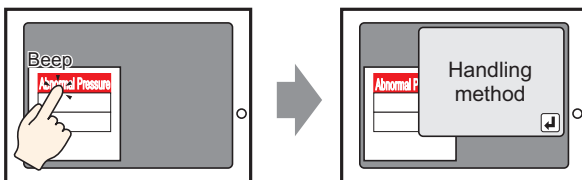

Touch the alarm, and a related window is displayed.

- ☞ Setup Procedure (page 19-35)
- ☞ Details (page 19-34)

Viewing Alarms by Line

Alarm blocks displayed on each screen can be changed.

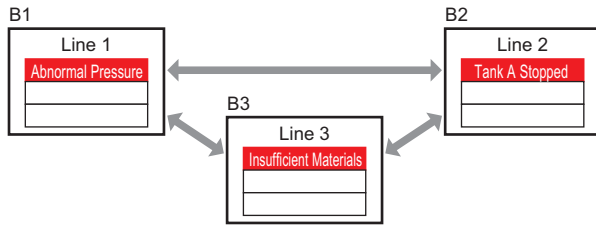

- ☞ Setup Procedure (page 19-50)
- ☞ Details (page 19-49)

Saving the Alarm History to a CF-Card

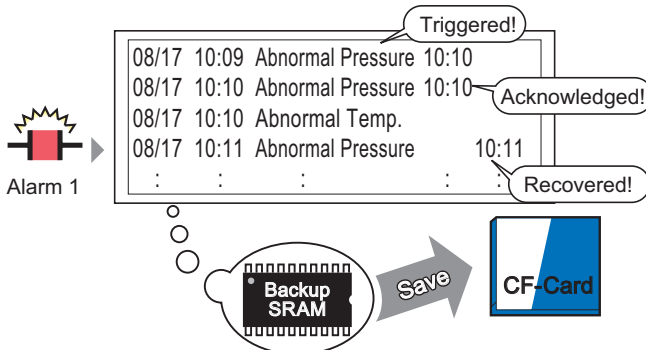

The Alarm History data stored in the backup SRAM is saved to the CF-card.

- ☞ Setup Procedure (page 19-57)
- ☞ Details (page 19-56)

19.2 Scrolling Alarm Messages

19.2.1 Details

When the Monitoring Bit Address turns ON, the Alarm scrolls across the screen.

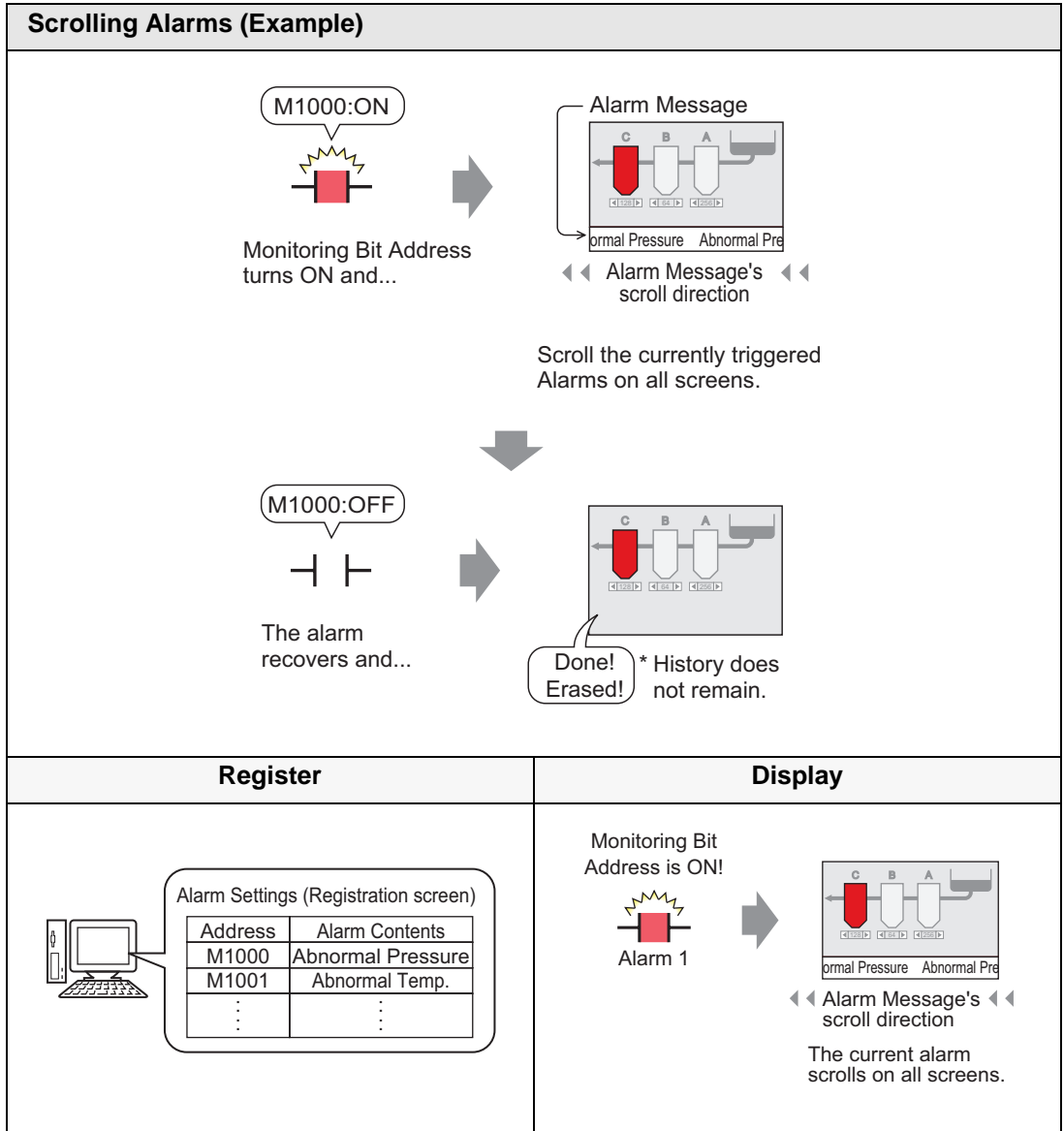

■ Display Example

◆ When a single alarm is triggered:

Monitoring Bit
Address is ON!



Alarm 1

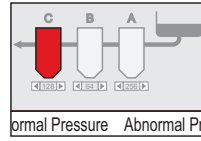

◀◀ Alarm Message's
scroll direction ▶▶

The current alarm scrolls
on all screens.

◆ When multiple alarms are triggered:

Monitoring Bit
Address is ON!



Alarm 1



Alarm 2

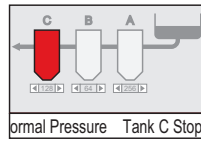

◀◀ Alarm Message's
scroll direction ▶▶

Currently triggered Alarm
scroll on all screens.

■ Display When Alarm Ends

◆ When a single alarm is triggered:

While the alarm is active, a repeating Alarm Message scrolls on the screen. Even when the Alarm recovers, the final message still displays until it finishes scrolling.

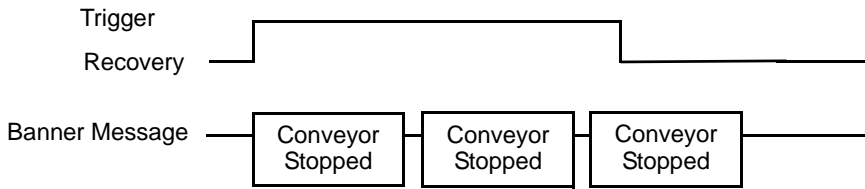

◆ When multiple alarms are triggered:

The messages of all active Alarms repeatedly scroll on the screen. When the [Conveyor Stopped] alarm recovers halfway through a message, the final [Conveyor Stopped] message scrolls until it is finished, and after that the [Abnormal Voltage] message displays repeatedly. Even when the [Abnormal Voltage] alarm recovers, the final message still appears until it finishes scrolling.

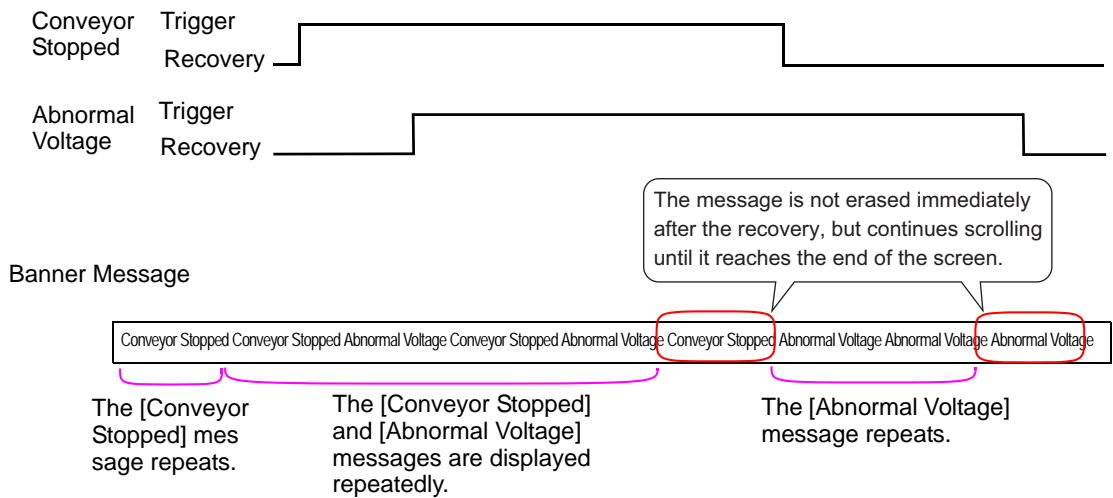

■ Alarm Message (Banner) Display Position

Alarm Messages (Banner) are displayed on the lower part of the GP screen but can also be displayed on the upper part, depending on the System Menu Window's display state.

◆ Normal Display

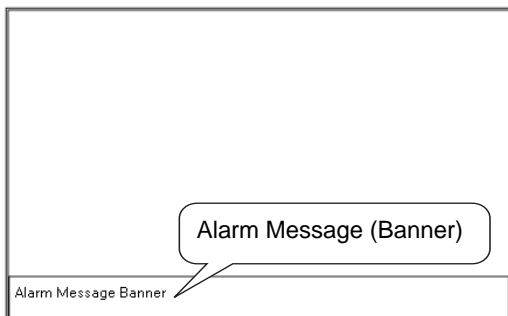

◆ Display layouts when the System Menu is combined with Alarm Message

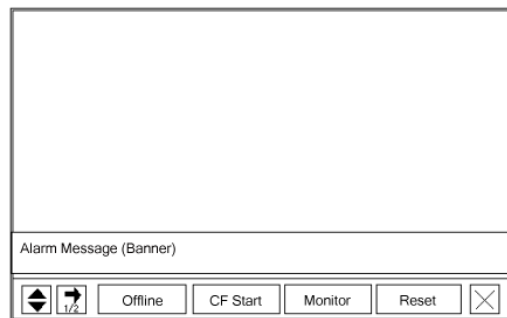
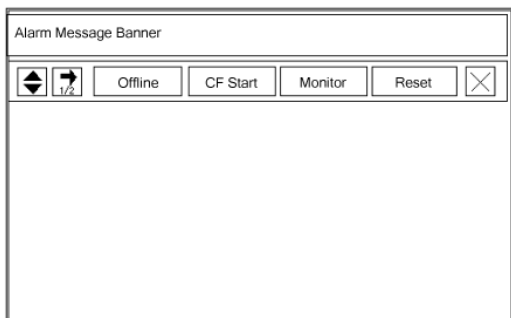
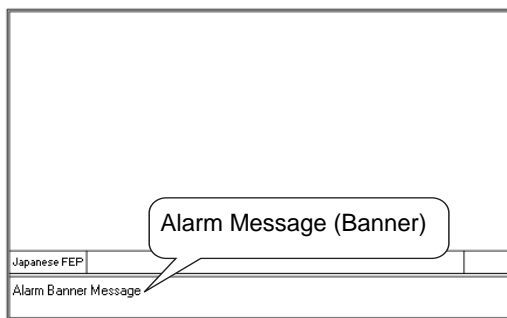

When Alarm Message (Banner) is displayed on the upper part of the screen and the Japanese FEP and the System Menu are closed, the Alarm Message is displayed on the lower part.

19.2.2 Setup Procedure

- NOTE** • Please refer to the settings guide for details.
 ☞ “19.9.1 Alarm Settings Guide ■ Alarm Settings Guide (Banner)” (page 19-82)

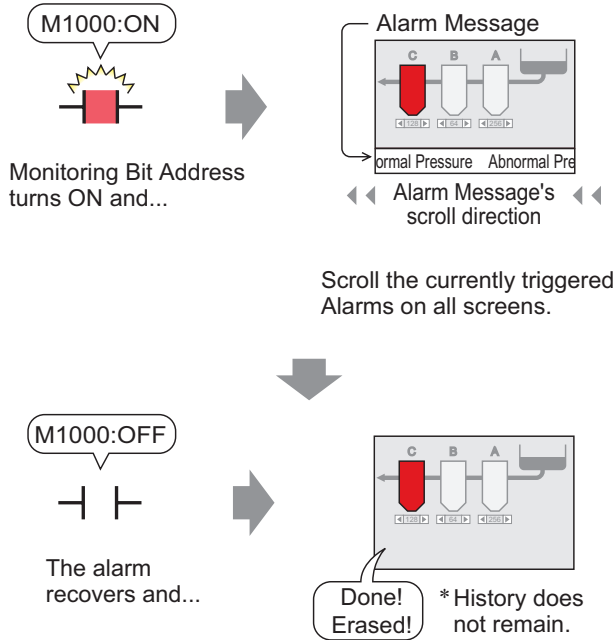

- 1 Select the [Common Settings (R)] menu - [Alarm Settings (A)] command, or click  to display the following screen. Specify a display language for the Alarm Message in [Language Settings].

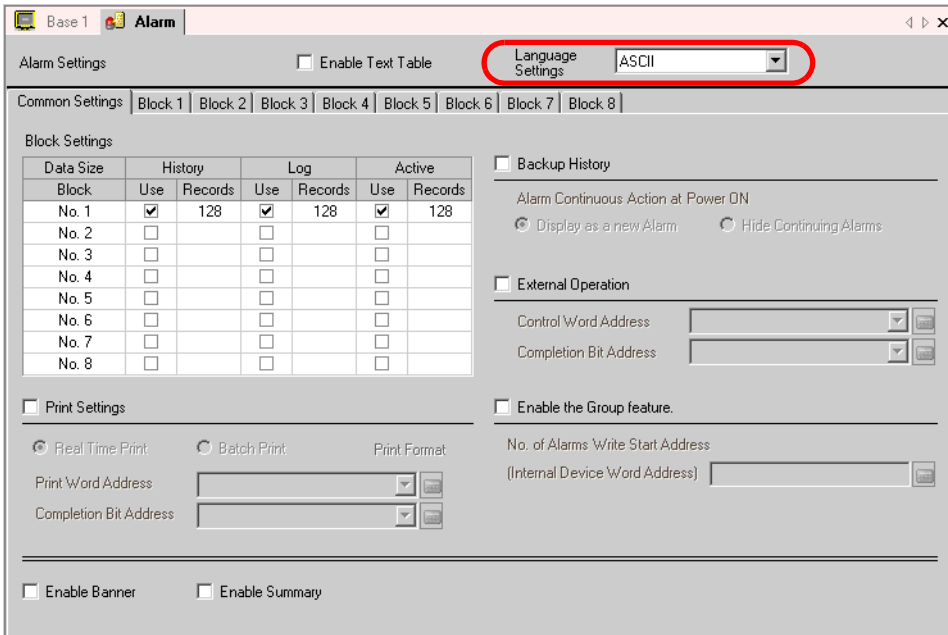

2 Check the [Enable Banner] box.

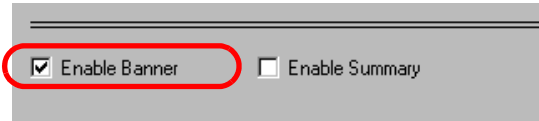

3 When the following notice message appears, click [Yes]. The [Banner] tab is displayed.

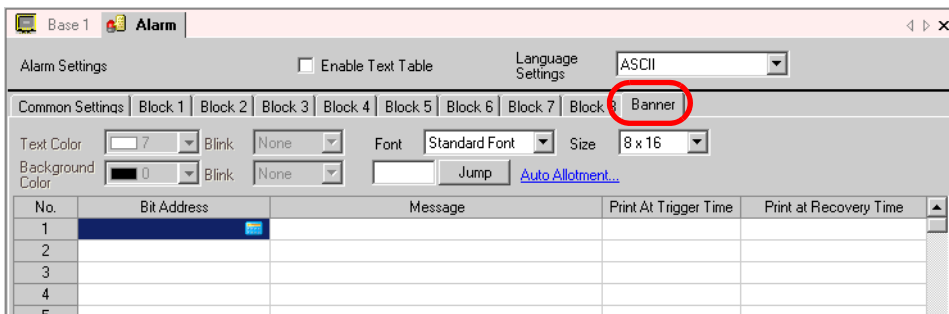
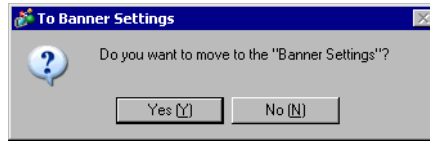

4 Set the [Bit Address] to monitor the alarm's trigger. (e.g.: M1000)

Click the icon to display an address input keypad.

Select device "M", input "1000" as the address, and press the "Ent" key.

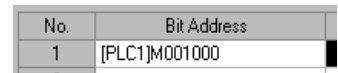
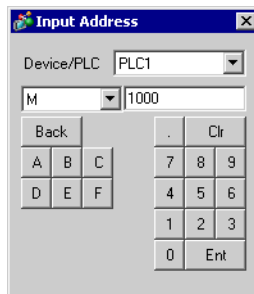
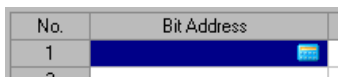

- 5 In the [Message] column, enter a message to scroll when an alarm is triggered, and specify [Text Color], [Background Color], and [Blink].

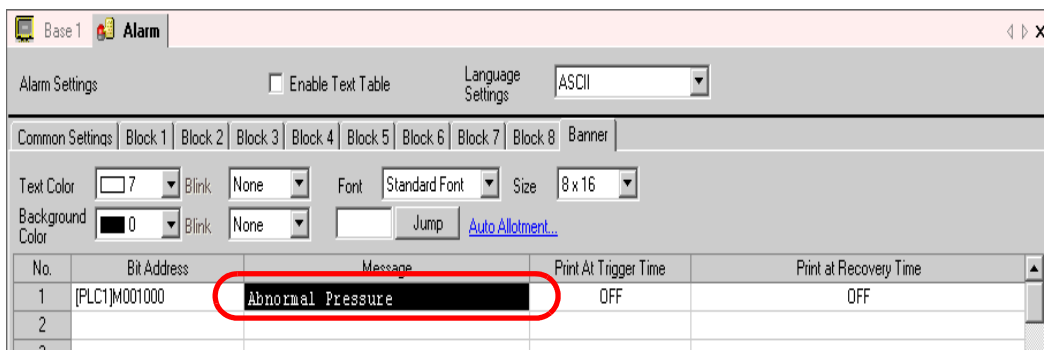

NOTE

- Up to 512 alarm messages can be registered.
- Set the monitoring bits within 128 words for the whole Alarm Message (Banner).
- Up to 160 single-byte characters can be registered in a single Alarm Message.
- When [Enable Text Table] is checked, the message language can be switched and displayed even while the system is running.
 - ☞ “15.4 Changing Languages (Multilanguage)” (page 15-15)

19.3 Viewing Active Alarms in a List

19.3.1 Details

When the Monitoring Bit Address turns ON, the Alarm scrolls across the screen.

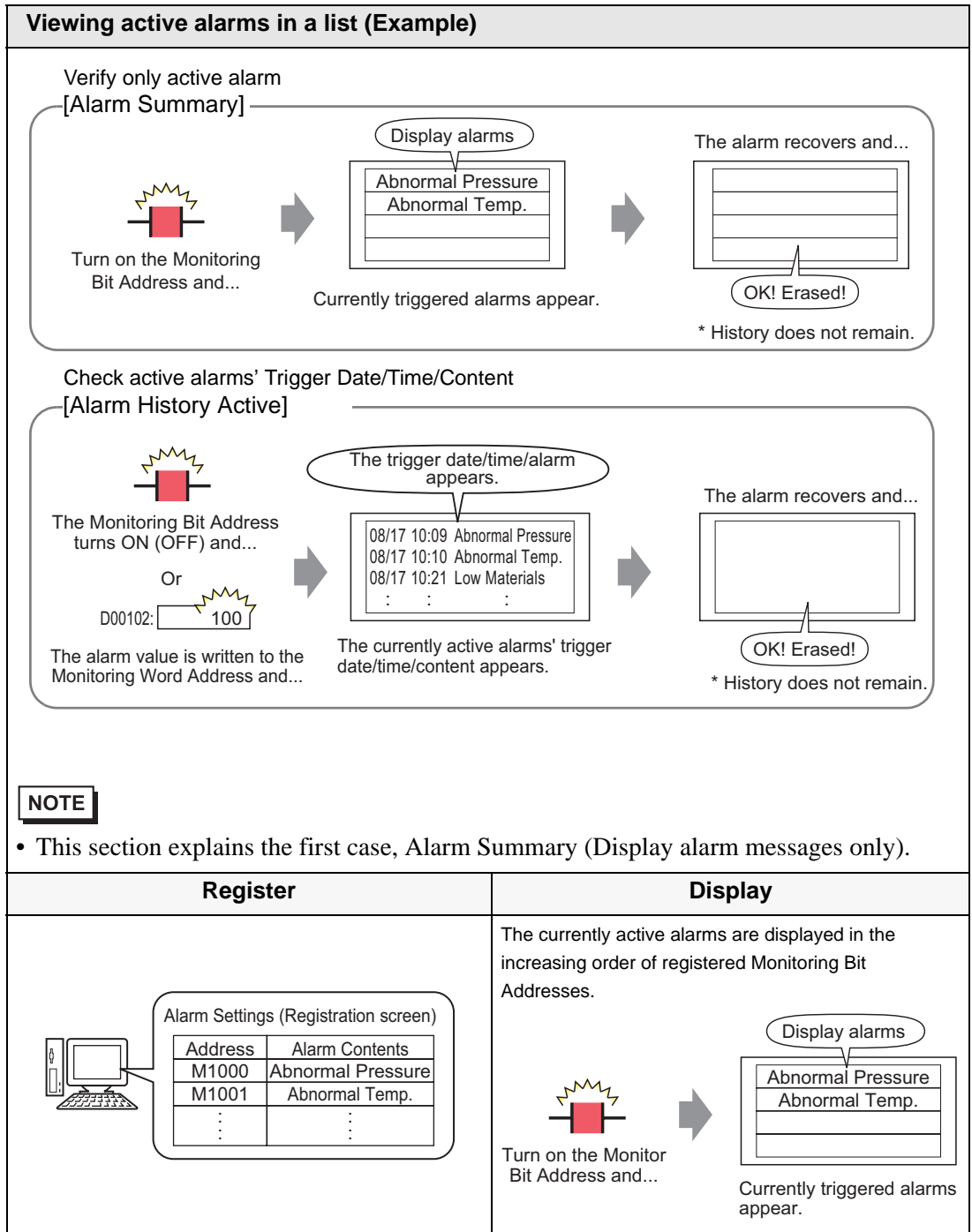

19.3.2 Setup Procedure

- NOTE**
- Please refer to the settings guide for details.
 - ☞ “19.9.1 Alarm Settings Guide ■ Alarm Settings Guide (Summary)” (page 19-85)
 - ☞ “19.9.2 Alarm Part Settings Guide ■ Summary” (page 19-121)
 - For details about placing parts or setting addresses, shapes, colors, and labels, please refer to Editing Parts.
 - ☞ “9.6.1 Editing Parts” (page 9-37)

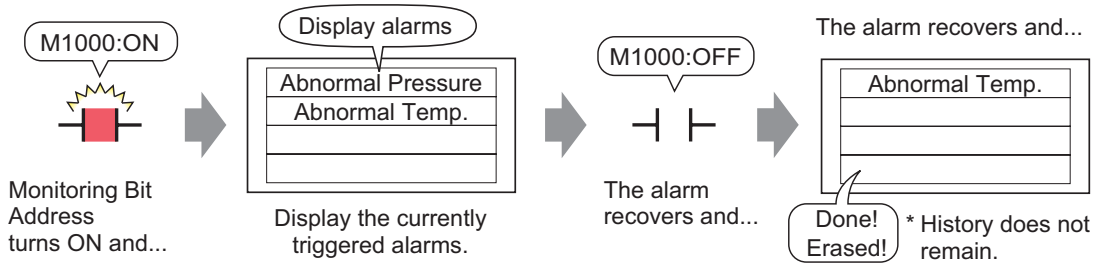

1 Select the [Common Settings (R)] menu - [Alarm Settings (A)] command, or click  to display the following screen. Specify a display language for the Alarm Message in [Language Settings].

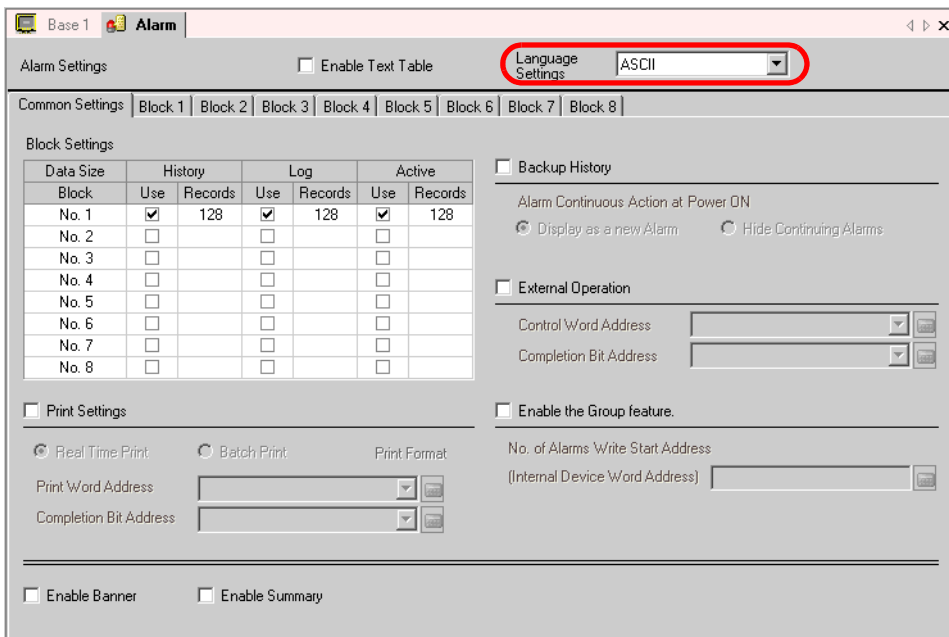

2 Check the [Enable Summary] box.

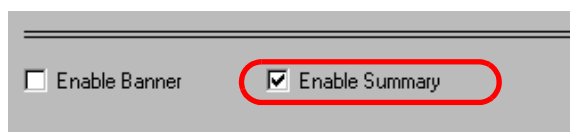

3 When the following notice message appears, click [Yes]. The [Summary] tab is displayed.

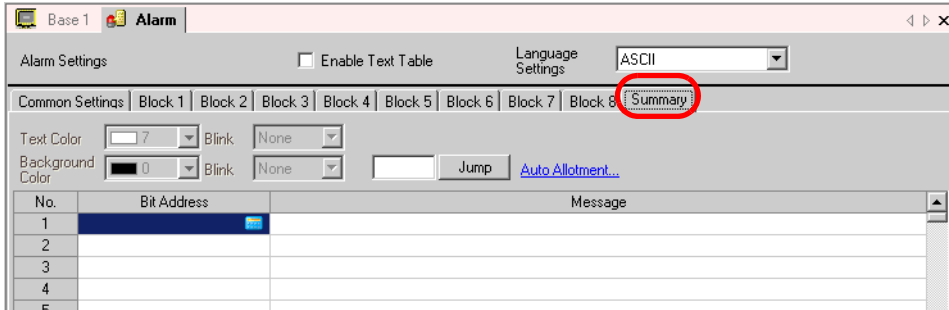
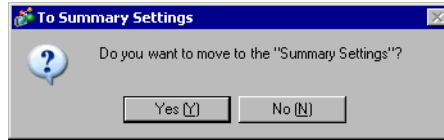

4 Set the [Bit Address] to monitor the alarm's trigger. (e.g.: M1000)

Click the icon to display an address input keypad.

Select device "M", input "1000" as the address, and press the "Ent" key.

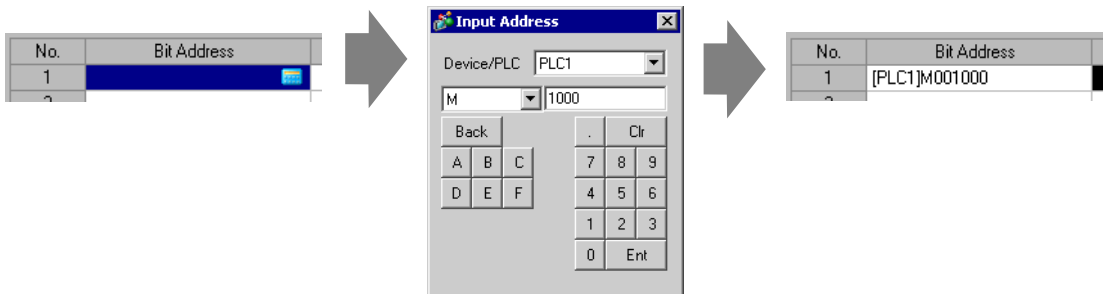

- 5 In the [Message] column, enter a message to display when an alarm is triggered, and specify [Text Color], [Background Color], and [Blink].

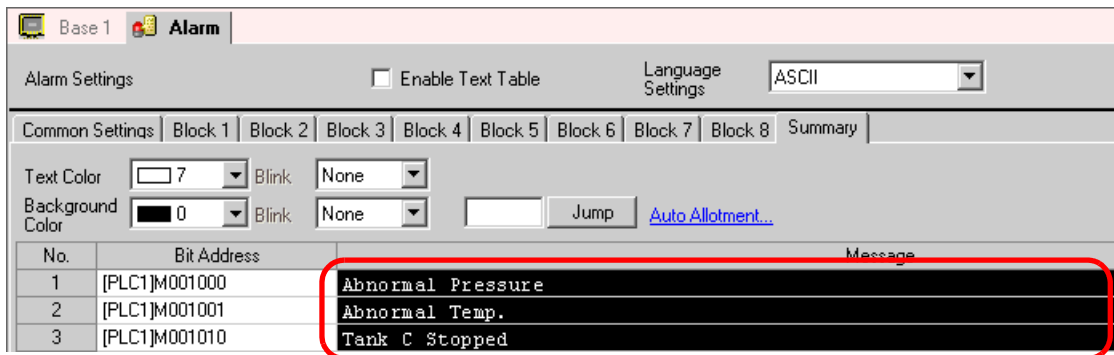
**IMPORTANT**

- Do not use the same address for multiple monitoring bits. When the same address is used for multiple monitoring bits, only the alarm message having the smallest registration number (Row No.) is displayed.
- In consecutive words, set up the monitor bit for the message you want to display on screen 1. If you set up monitor bits on different devices, or within the same device but in non-sequential words, you cannot display the message on the same screen.

NOTE

- Up to 8,999 alarm messages can be registered.
- Up to 160 single-byte characters can be registered in a single Alarm Message.
- When [Enable Text Table] is checked, the message language can be switched and displayed even while the system is running.
☞ "15.4 Changing Languages (Multilanguage)" (page 15-15)

- 6 Open the screen editor, and set the Alarm part to display as a Summary. Select the [Part (P)] menu - [Alarm (A)] command or click  and place the Part on the screen.



7 Double-click the placed Alarm and the settings dialog box opens. Select [Summary].

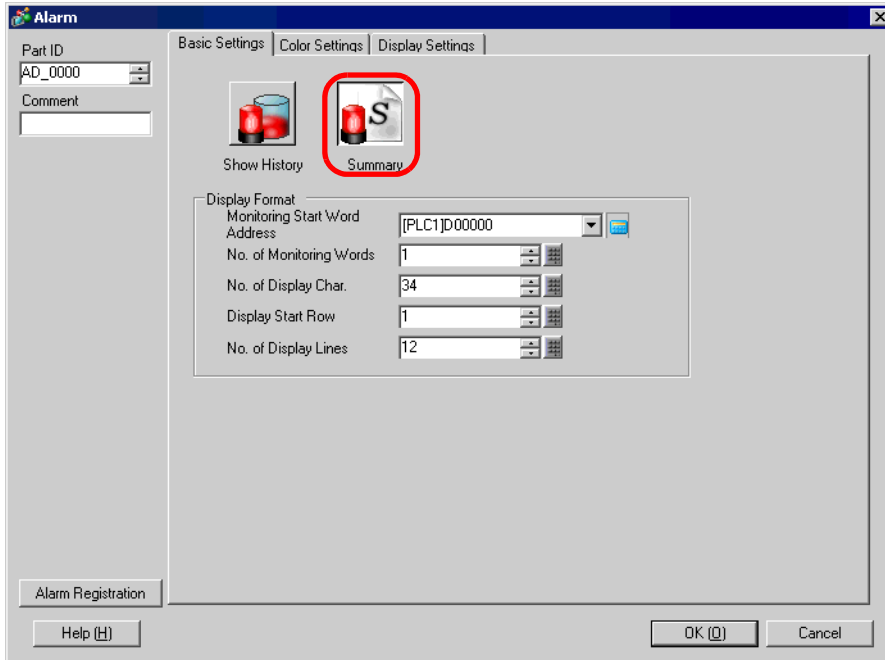

8 In [Monitoring Start Word Address], set the start address of the bit address registered in [Alarm Settings] by using the value converted into a 16-bit word. For example, to display the message of the registered monitoring bit “M1000” in a Summary, specify “M992” in [Monitoring Start Word Address], because addresses from M992 to M1008 are included in one word.

Click the icon to display an address input keypad.

Select device [M], input [992] as the address, and press the [Ent] key.

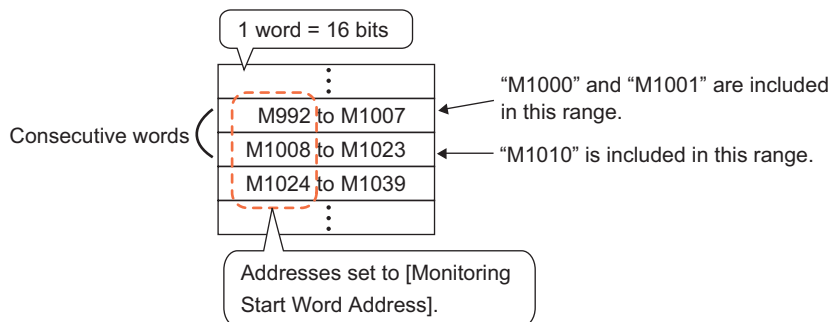
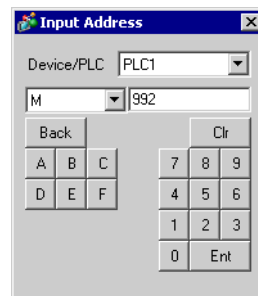

- 9 In [No. of Monitoring Words], allocate monitoring bit addresses by defining the number of words from the [Monitoring Word Address]. (Example: 2)

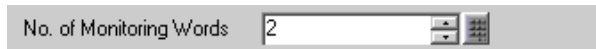

- 10 Set the [No. of Display Char.], [Display Start Row], and [No. of Display Lines] of the message which is to be displayed on the screen.

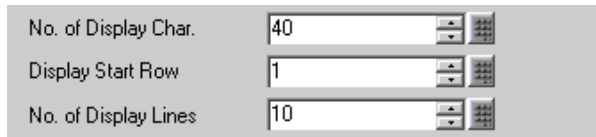

- 11 Set the color to be used when Alarm Message is cleared (recovered) in the [Color Settings] tab, set the font and size of the message in the [Display Settings] tab, and click [OK].

NOTE

- You can draw one Alarm part (alarm summary) on one base screen. If you want multiple alarm parts on the same screen, use Window parts to load and display Window Screens set up with alarm parts.
 - Each alarm message can have a maximum 160 characters. You can display up to 50 rows on a single screen. When displaying alarms on the GP, the maximum number of characters per row and the maximum number of rows per screen depends on the GP model and the font size.
 - If the Alarm Message is wider than the display area, the portion that exceeds the area is truncated and is not displayed.
 - By setting Alarm Parts [Summary] on multiple screens, a maximum of 1,600 Alarm Messages can be displayed in an entire project.
 - Place the Alarm Parts [Summary]'s display areas so that they do not overlap with other parts or objects.
-

19.4 Acknowledging the Alarm History

19.4.1 Details

When the Monitoring Bit Address turns ON/OFF, or when alarm data is written to the Monitoring Word Address, the Alarms are listed together with its trigger date/time. There are 3 ways to view the Alarms: “Active”, “Log”, and “History”.

Acknowledging the Alarm History (Example)

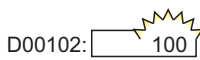
 Or 

The Monitoring Bit Address turns ON (OFF) and...

The alarm value is written to the Monitoring Word Address and...

Displays the currently active alarms in the order of their trigger date/time, and the Alarm History of past alarms.

All active Alarms can be viewed in a list.

[Active]

Trigger date	Time	Alarms
08/17	10:09:00	Abnormal Pressure
08/17	10:10	Abnormal Temp.
08/17	10:21:00	Insufficient Materials
:	:	:

* The recovered alarm is cleared and no history remains.

Display Alarms separately by Trigger, Acknowledge, and Recovery.

[Log]

08/17 10:09:00	Abnormal Pressure	Triggered!
08/17 10:10	Abnormal Pressure 10:10	Acknowledged!
08/17 10:10	Abnormal Temp.	
08/17 10:11:00	Abnormal Pressure	10:11 Recovered!
:	:	:

* Even when the alarm recovers, the history remains.

Display the Trigger time, Acknowledge time, and Recovery time for all Alarms on the same line.

[History]

08/17 10:09:00	Abnormal Pressure	10:10	10:11
08/17 10:10	Abnormal Temp.		
08/17 10:11	Insufficient Materials		10:11
:	:	:	:

* Even when the alarm recovers, the history remains.

1. Register



Alarm Settings (Registration Screen)

Address	Alarm Contents
X1000	Abnormal Pressure
X1010	Abnormal Temp.
:	:

2. Display



08/17 10:09	Abnormal Pressure	Triggered!
08/17 10:10	Abnormal Pressure 10:10	
08/17 10:10	Abnormal Temp.	Acknowledged!
08/17 10:11	Abnormal Pressure	10:11 Recovered!
:	:	:

19.4.2 Setup Procedure

■ Bit Monitoring

- NOTE**
- Please refer to the settings guide for details.
 - ☞ “19.9.1 Alarm Settings Guide ■ Alarm Settings Guide (Block 1) ◆ Bit Monitoring” (page 19-74)
 - ☞ “19.9.2 Alarm Part Settings Guide ■ Show History” (page 19-88)
 - For details about placing parts or setting addresses, shapes, colors, and labels, please refer to Editing Parts.
 - ☞ “9.6.1 Editing Parts” (page 9-37)

When the Monitoring Bit Address turns ON, the Alarms are displayed together with their trigger date/time. When the Monitoring Bit Address turns OFF, the recovery time is added on the same row.

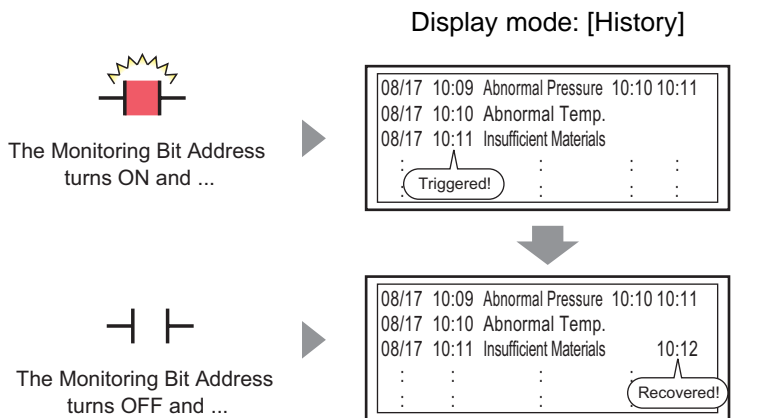

* Even when the alarm recovers, the history remains.

- 1 Select the [Common Settings (R)] menu - [Alarm Settings (A)] command, or click  to display the following screen. Specify a display language for the Alarm Message in [Language Settings].

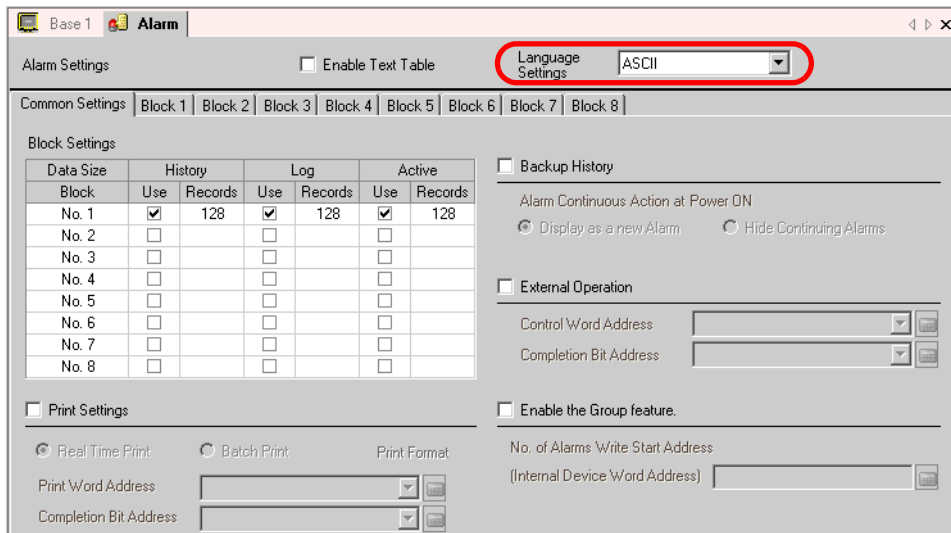

- On the [Block Settings] tab, check the box for the desired display mode (History/Log/Active) for the block to which the message is registered, and set the number of messages stored as history for each mode.

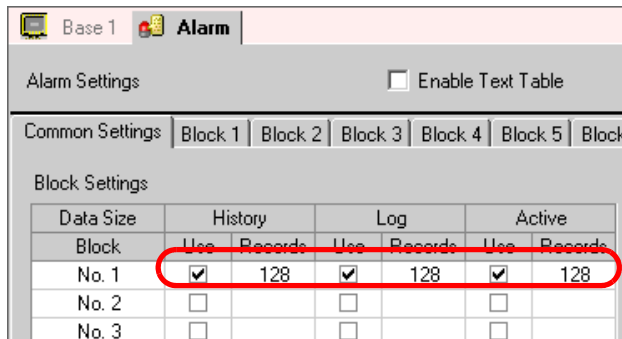

- Select the [Backup History] and [Hide Continuing Alarms] check boxes.



IMPORTANT

- When the [Backup History] box is not checked, the alarm history data will be erased when the GP unit is turned OFF or reset.

- Open the [Block 1] tab, and select [Bit Monitoring].

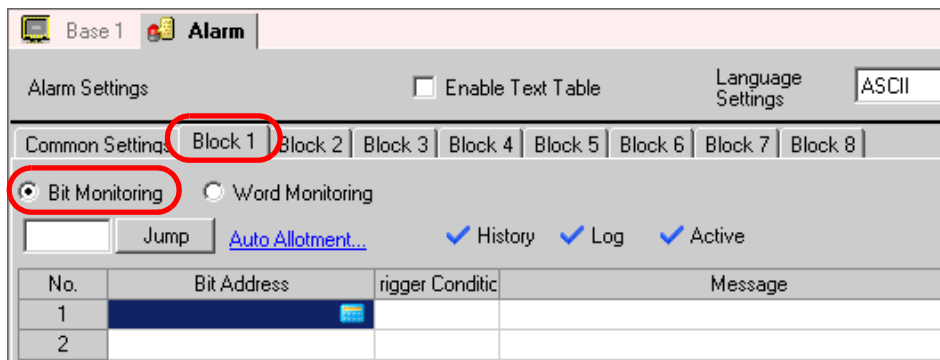

- In [Bit Address], set the bit address to monitor the alarm's trigger. (e.g.: M1000)

Click the icon to display an address input keypad.

Select device "M", input "1000" as the address, and press the "Ent" key.

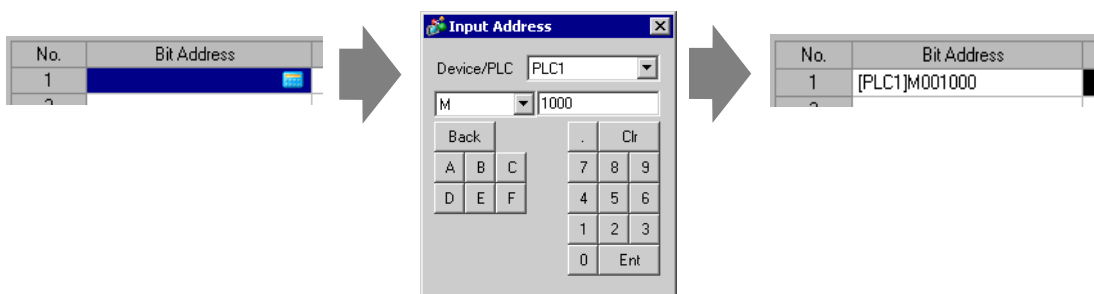

6 In the [Trigger Condition] cell, select whether the alarm is triggered when the Monitoring Bit Address turns ON or turns OFF.

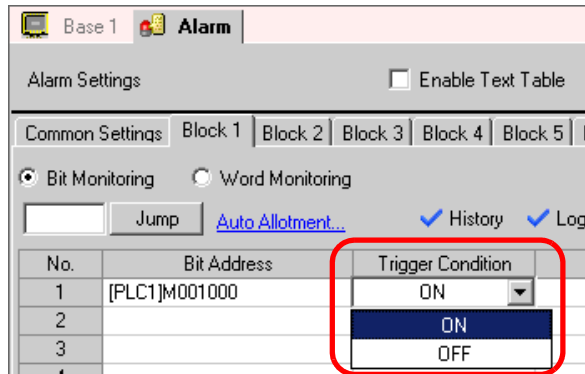

7 In the [Message] cell, input the alarm message that will display when the alarm is triggered.

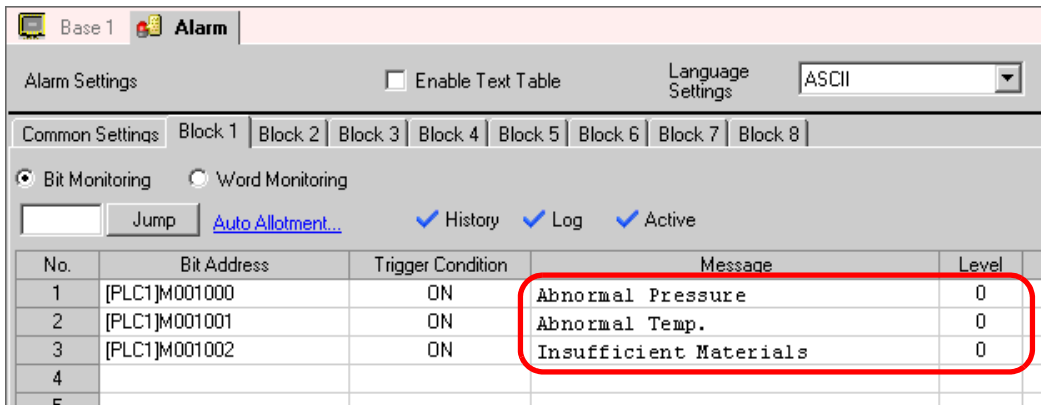

- NOTE**
- Up to 160 single-byte characters can be registered in a single Alarm Message.
 - When [Enable Text Table] is checked, the message language can be switched and displayed even while the system is running.
 ☞ “15.4 Changing Languages (Multilanguage)” (page 15-15)

8 Open the screen editor, and set the Alarm part which will display the Alarm. Select the [Part (P)] menu - [Alarm (A)] command or click  and place the Part on the screen.

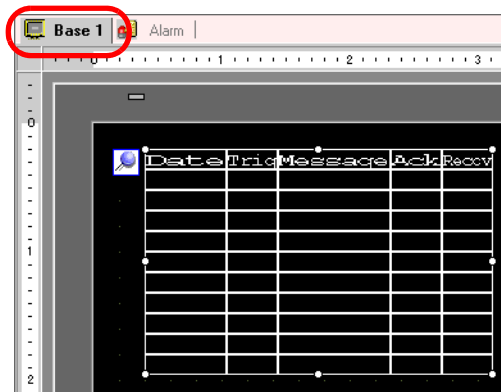

9 Double-click the placed Alarm and the settings dialog box opens.

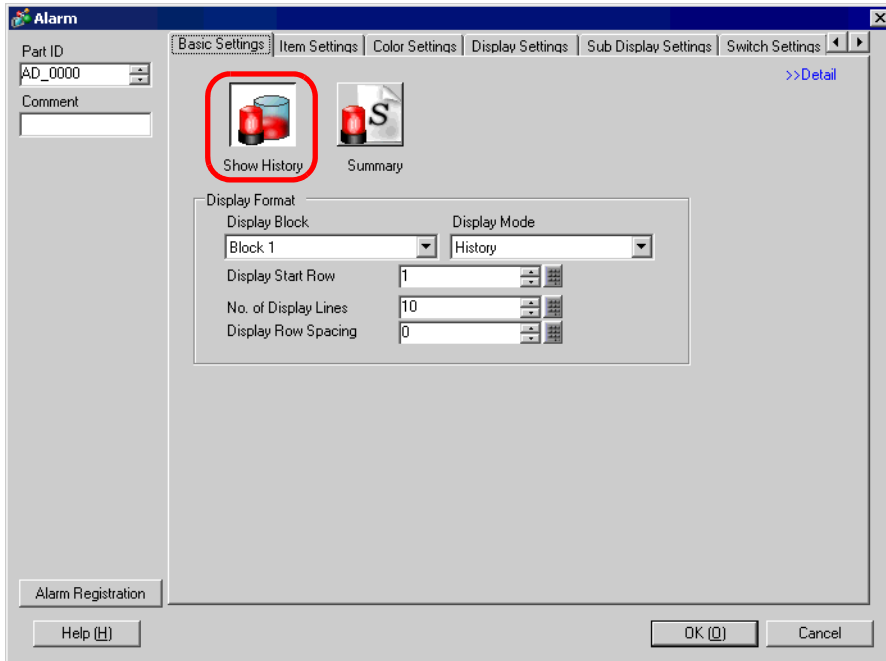

10 Set the block and mode to be displayed for the Alarm.

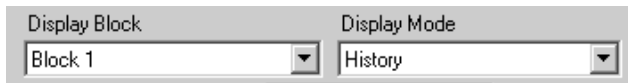

11 Set the [Display Start Row], [No. of Display Lines] and [Display Row Spacing].

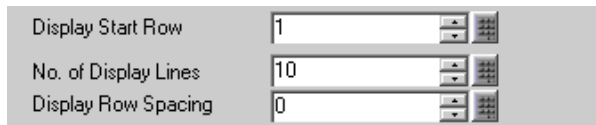

12 As needed, set the number of display characters, text color, background color, font, and size of the alarm message in the [Item Settings] tab, [Color Settings] tab, and [Display Settings] tab. Click [OK].

■ Word Monitoring

NOTE

- Please refer to the settings guide for details.
 - ☞ “19.9.1 Alarm Settings Guide ■ Alarm Settings Guide (Block 1) ◆ Word Monitoring” (page 19-77)
 - ☞ “19.9.2 Alarm Part Settings Guide ■ Show History” (page 19-88)
- For details about placing parts or setting addresses, shapes, colors, and labels, please refer to Editing Parts.
 - ☞ “9.6.1 Editing Parts” (page 9-37)

When the alarm value is written to the Monitoring Word Address, the alarm is displayed together with the trigger date/time. When a value other than the alarm value is written, the recovery time is added to the same row.

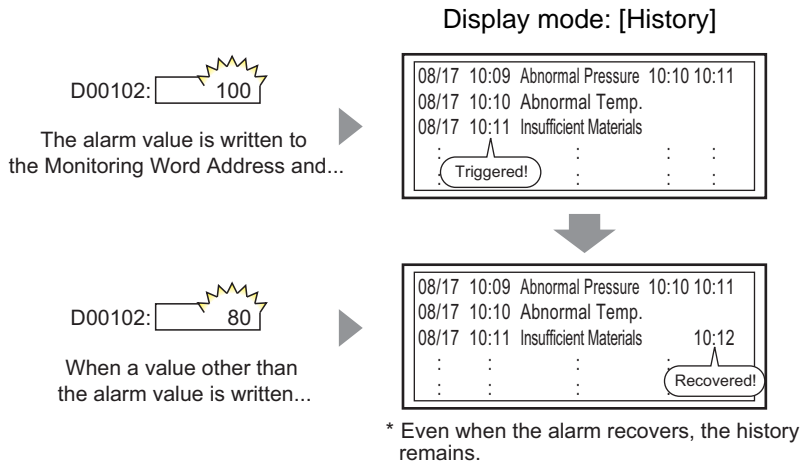

- 1 Select the [Common Settings (R)] menu - [Alarm Settings (A)] command, or click  to display the following screen. Specify a display language for the Alarm Message in [Language Settings].

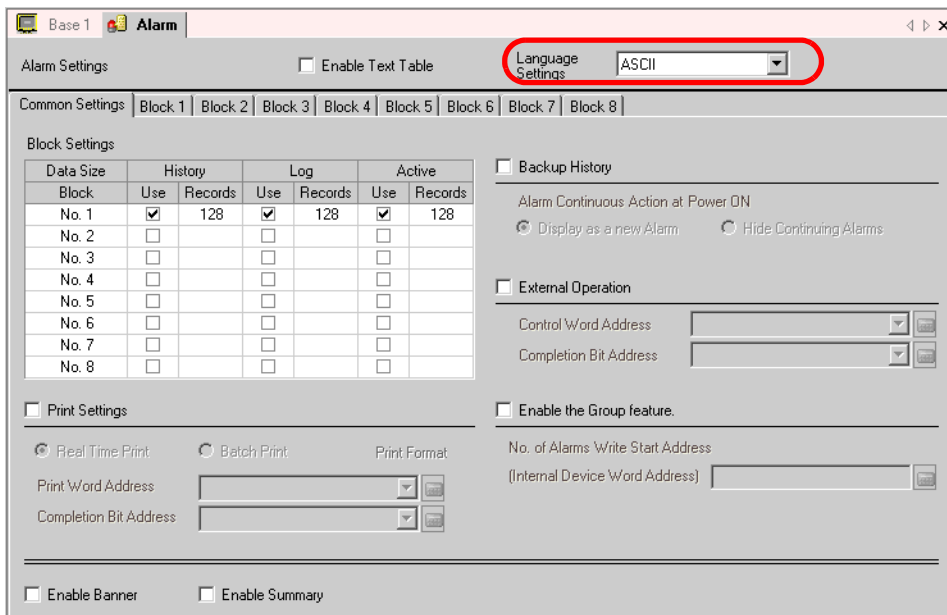

- On the [Block Settings] tab, check the box for the desired display mode (History/Log/Active) for the block to which the message is registered, and set the number of messages stored as history for each mode.

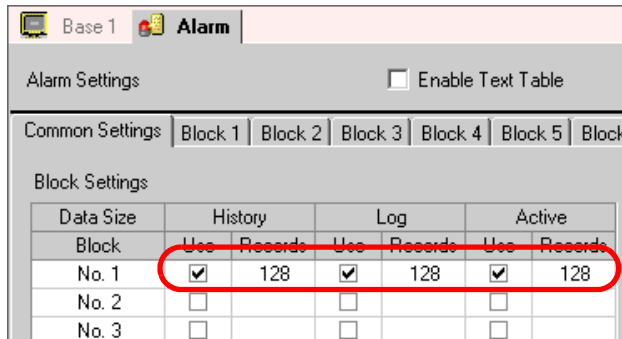

- Check the [Backup History] box and select [Hide Continuing Alarms].

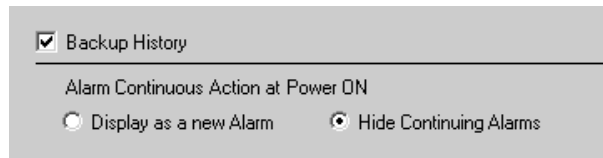

IMPORTANT

- When the [Backup History] box is not checked, the alarm history data will be erased when the GP unit is turned OFF or reset.

- Open the [Block 1] tab, and select [Word Monitoring].

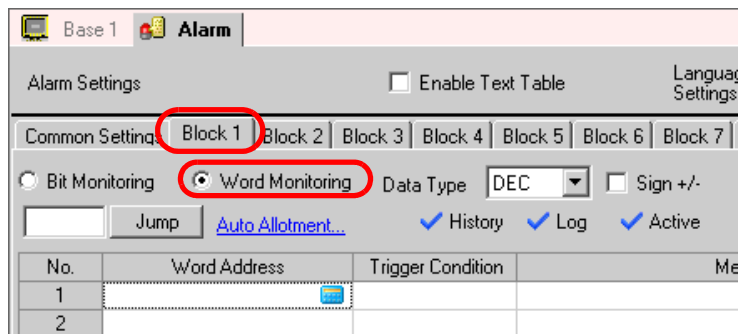

- In [Data Type], select the data type of the [Alarm Value] to store in [Word Address].

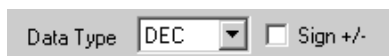

NOTE

- [Sign +/-] can only be set when the [Data Type] is [DEC].

6 In [Word Address], set the word address to monitor the alarm's trigger. (e.g.: D102)

Click the icon to display an address input keypad.

Select device "D", input "102" as the address, and press the "Ent" key.

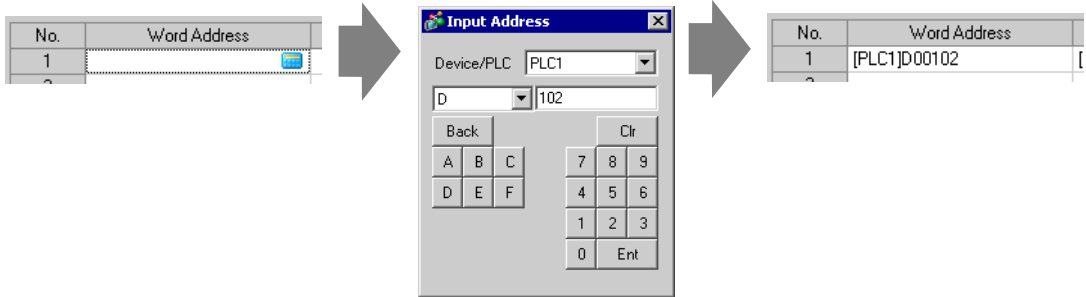

7 Click the [Trigger Condition] cell, then click , and the [Trigger Condition Settings] dialog box will be displayed.

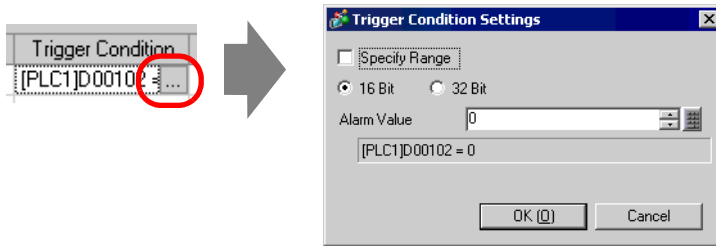

8 Select the bit length, set [Alarm Value] (e.g.: 100), and click [OK].

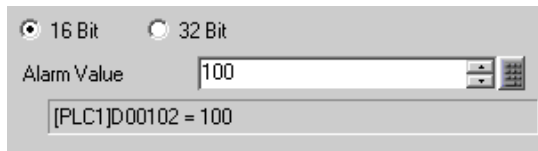

9 In the [Message] cell, input the alarm message that will display when the alarm is triggered.

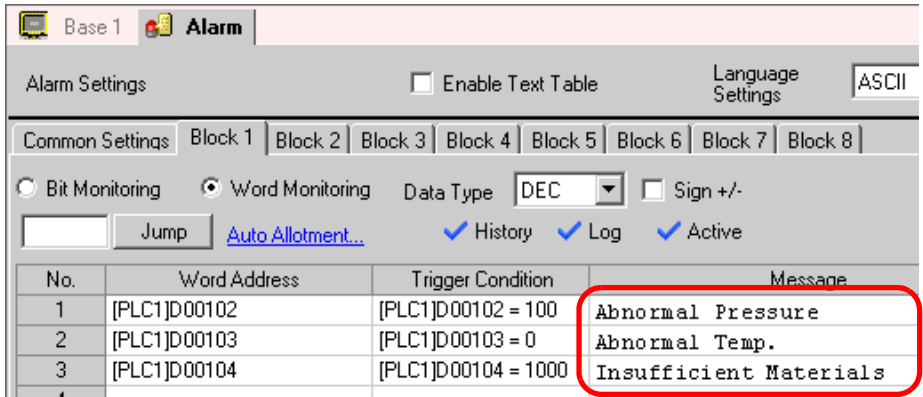

- NOTE**
- Up to 160 single-byte characters can be registered in a single Alarm Message.
 - When [Enable Text Table] is checked, the message language can be switched and displayed even while the system is running.
 ☞ “15.4 Changing Languages (Multilanguage)” (page 15-15)

10 Open the screen, and set the Alarm that will display the History. Select the [Part (P)] menu - [Alarm (A)] command or click  and place the Part on the screen.

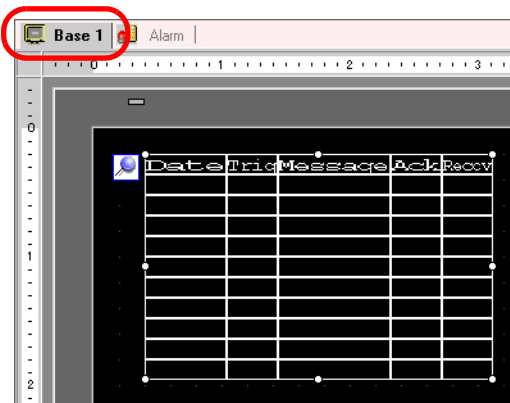

11 Double-click the placed Alarm and the settings dialog box opens.

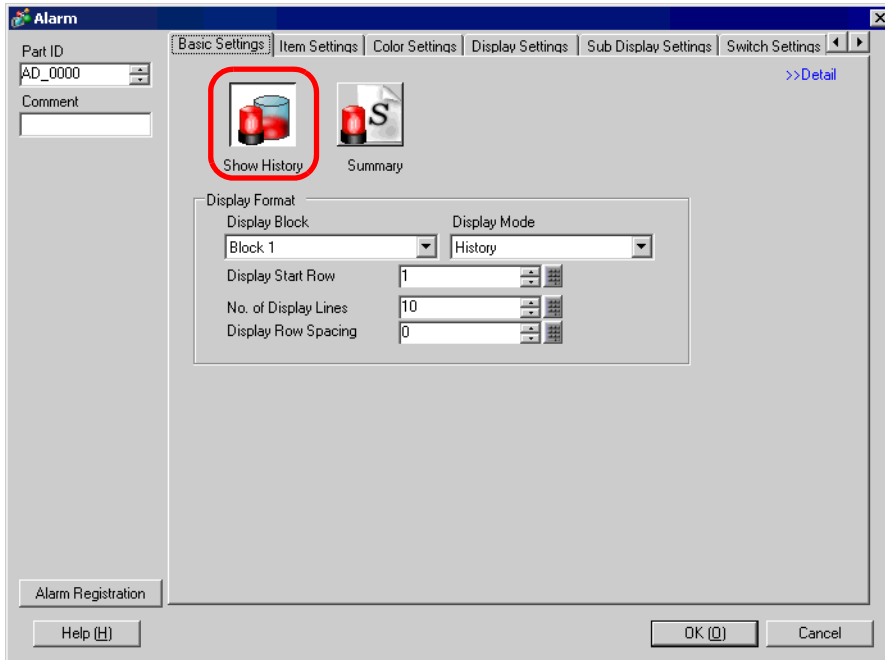

12 Set the block and mode to be displayed for the Alarm.



13 Set the [Display Start Row], [No. of Display Lines] and [Display Row Spacing].

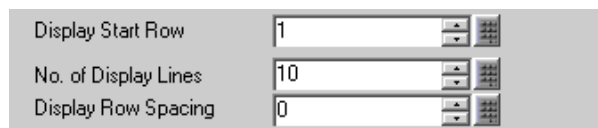

14 As needed, set the number of display characters, text color, background color, font, and size of the alarm message in the [Item Settings] tab, [Color Settings] tab, and [Display Settings] tab. Click [OK].

NOTE

- Up to 2,048 Alarm Messages (History) can be registered but the maximum number of alarms that can be stored in the GP (as [History], [Log], and [Active]) is 768.
- When using multiple blocks, the total Alarm Messages that can be set for all blocks is 768.
 - ☞ “19.7 Viewing Alarms by Line” (page 19-49)
- The Monitoring Bit Address and Monitoring Word Address must be set within 256 words of the Alarm Message (History).
- The maximum number of characters on one line and lines on one screen are decided by the GP type and [Size].
- If your message is wider than the display area, the portion that exceeds the area is truncated and is not displayed.
- For [Word Monitoring], if the alarm value stored in the [Word Address] fluctuates frequently, the alarm will be triggered often.

e.g.) When [Alarm Value] = 100

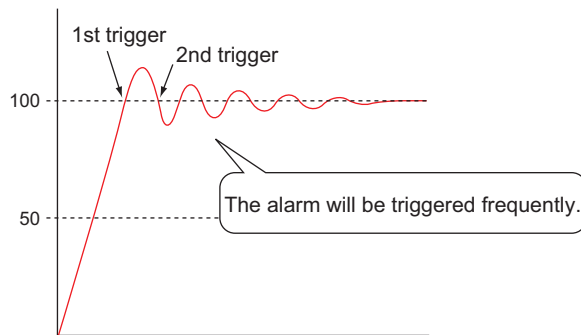

19.5 Working with Alarm History

19.5.1 Details

Select an operation switch to display an Alarm Message.

Several operations are available such as scrolling and sorting the displayed messages, and acknowledging and erasing the selected alarm message.

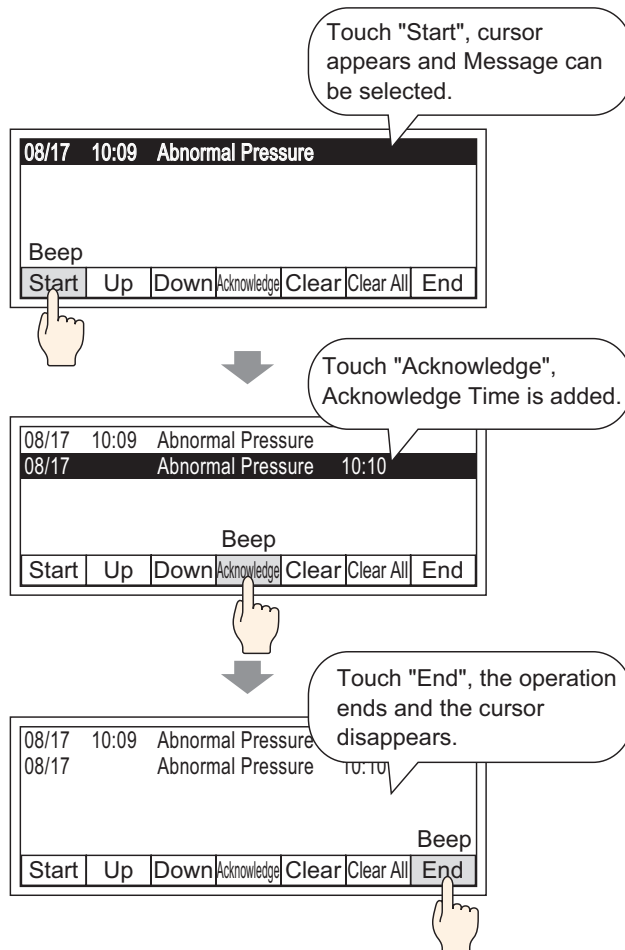

19.5.2 Setup Procedure

- NOTE**
- Please refer to the settings guide for details.
 - ☞ “19.9.2 Alarm Part Settings Guide ■ Show History ◆ Switch Settings” (page 19-113)
 - For details about placing parts or setting addresses, shapes, colors, and labels, please refer to Editing Parts.
 - ☞ “9.6.1 Editing Parts” (page 9-37)

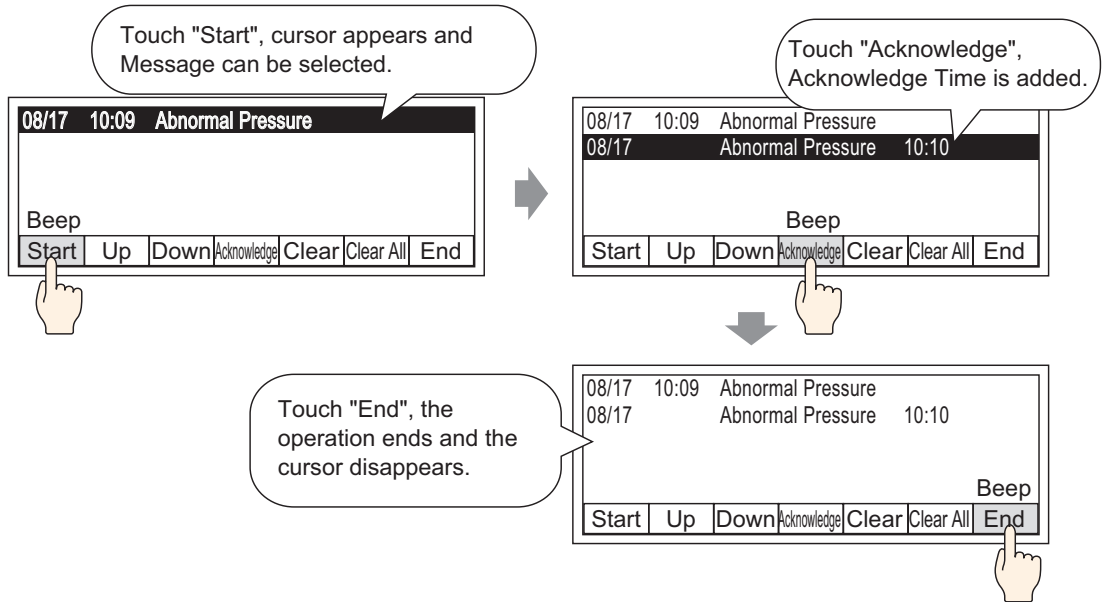

- 1 Double-click the placed Alarm and the settings dialog box appears. Open the [Switch Settings] tab, and put a check mark next to all the items to use for the Switch.

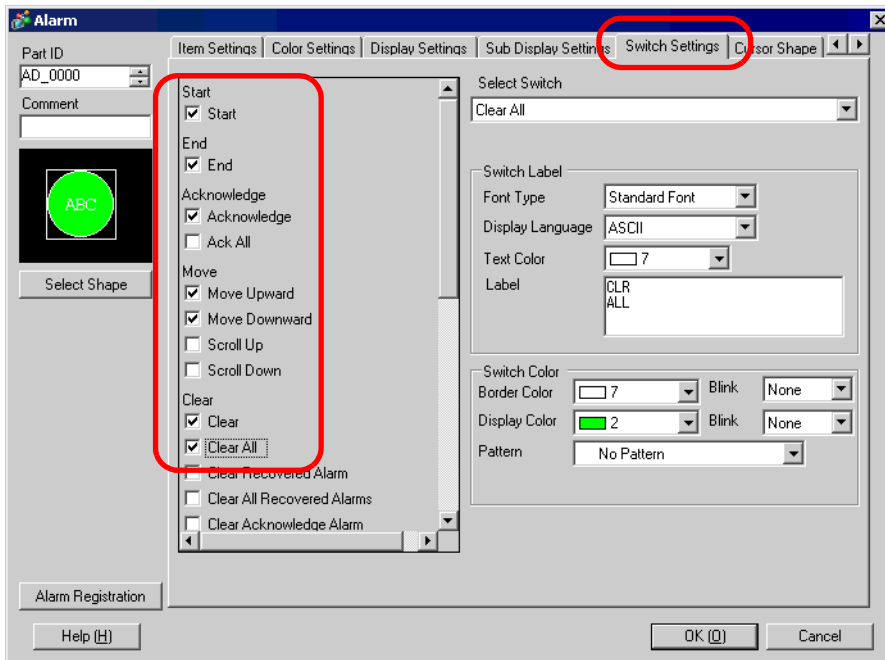

- 2 Select the Switch's shape from [Select Shape].
- 3 Choose the switch with [Select Switch], and designate the switch label's [Font Type], [Display Language], [Text Color] and [Label].

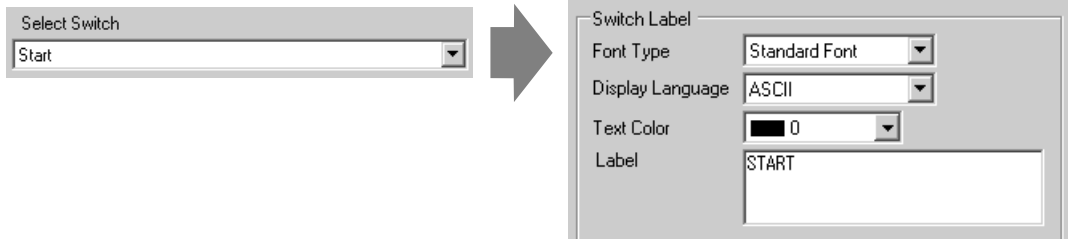

- 4 As necessary, set the Switches' colors in [Switch Color].

NOTE • The Switch Color and Shape settings are common to all Alarm parts, regardless of the switch type selected. To change the shape and color for each switch, use a Switch Lamp Part [Special Switch (Alarm History Switch)].

☞ "11.14.4 Special Switch ■ Switch Feature ◆ Alarm History Switch" (page 11-63)

- 5 Click the [Cursor Shape] tab, select [Cursor Shape] as [Reverse], and click [OK].

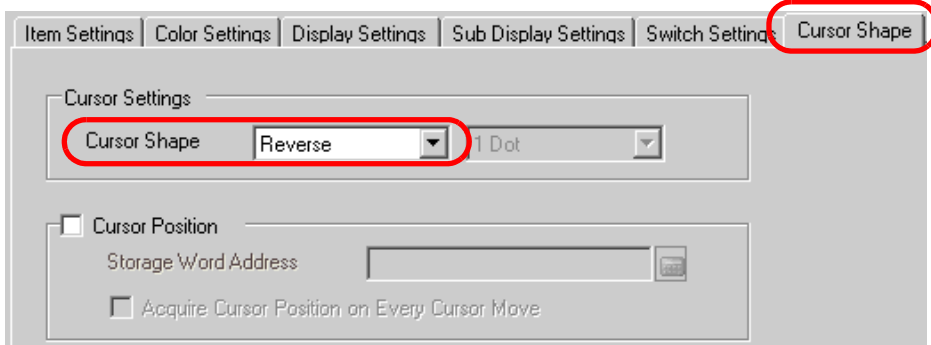

NOTE

- In order to use an Alarm Part (History) Switch, only 1 Alarm Part should be used per screen.

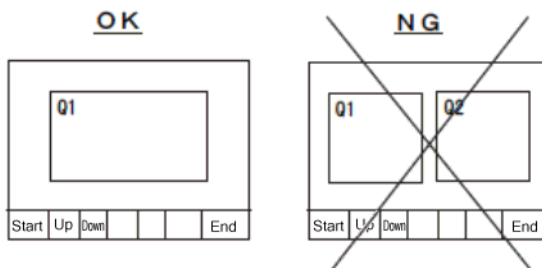

- Set the switches to the same screen that the Alarm Part is set to. They cannot be used if they are set to another screen.

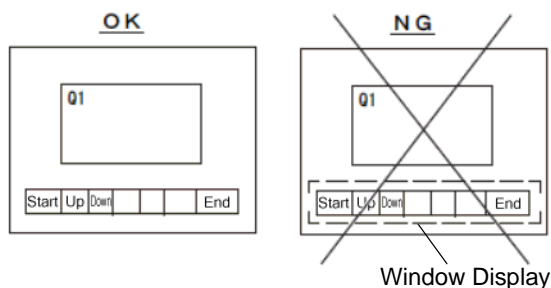

- When using the [Clear All No. of Occurrences], [Clear All Accumulated Time], and [Clear Individual Accumulated Time] switches, please be aware that data stored in the backup SRAM of the GP is also erased (cleared to “0”), not just the displayed values.
- When sort switches are placed on the screen and any of the switches (other than the [In Reverse Order of Trigger Date] switch) is pressed, it may take longer than usual to update the screen at a screen change.
- When sorting is performed on 2 blocks simultaneously such as [Level & In Reverse Order of Trigger Date], it may take longer than usual to display the result.

19.6 Displaying Help (Sub Display)

19.6.1 Details

■ Change Base Screen

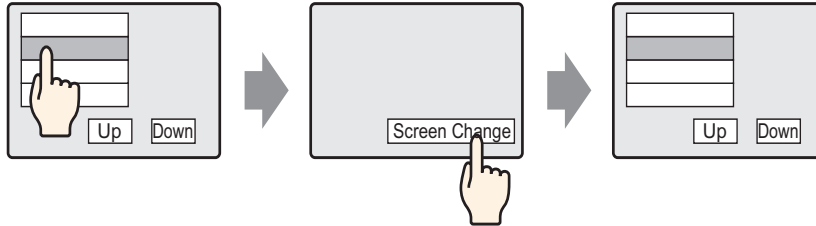

Touch the alarm message, and the screen changes to another screen according to the alarm.

Return to alarm screen using Change Screen Switch

■ Show Text Window

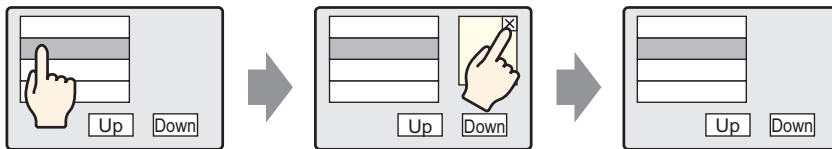

Touch the alarm message, and a Text Window is displayed according to the alarm.

Touch the Window Clearing Switch to close the Text Window.

19.6.2 Setup Procedure

■ Change Base Screen

NOTE

- Please refer to the settings guide for details.
 - ☞ “11.14.3 Change Screen Switch ■ Switch Feature” (page 11-60)
 - ☞ “19.9.1 Alarm Settings Guide ■ Alarm Settings Guide (Block 1)” (page 19-74)
 - ☞ “19.9.2 Alarm Part Settings Guide ■ Show History” (page 19-88)
- For details about placing parts or setting addresses, shapes, colors, and labels, please refer to Editing Parts.
 - ☞ “9.6.1 Editing Parts” (page 9-37)

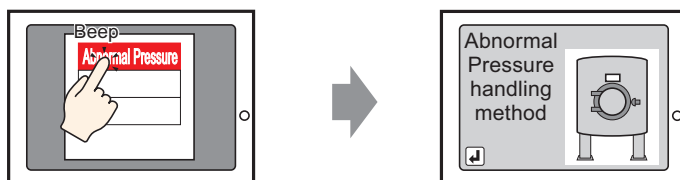

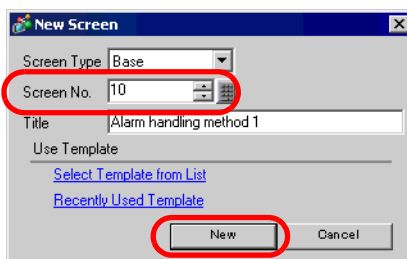

Touch the alarm, and the screen changes to another screen.

- 1 Create a Base Screen to use for a Sub Display. Select the [Screen (S)] menu - [New Screen (N)] command, or click  and the [New Screen] dialog box appears.
- 2 In [Screen No.], set the Base Screen No. (e.g.: 10) used for the Sub Display, and click [New].

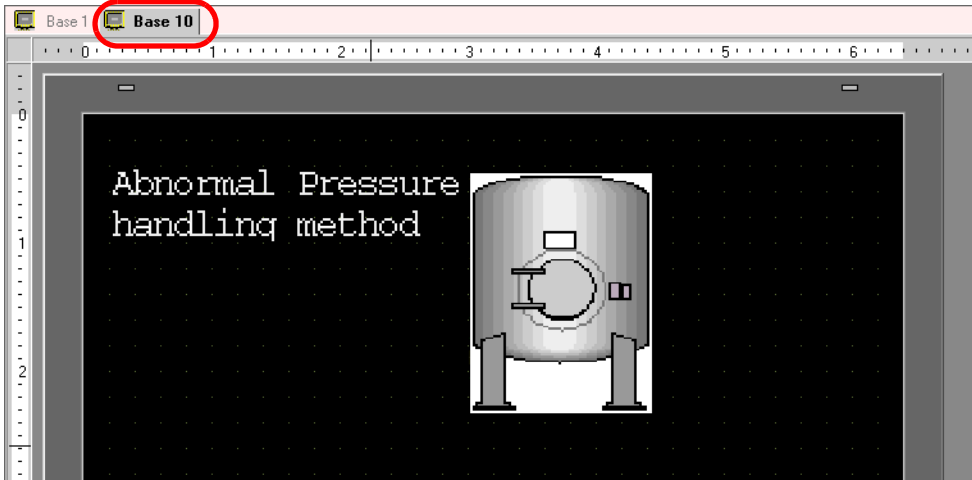

3 When Base Screen “10” appears, create the Base Screen for the Sub Display.



4 Set the Switch to change from the Sub Display screen to the Alarm Part placement screen. Select the [Part (P)] menu - [Switch/Lamp (C)] - [Change Screen Switch (C)], or click , and place the Switch on the screen.

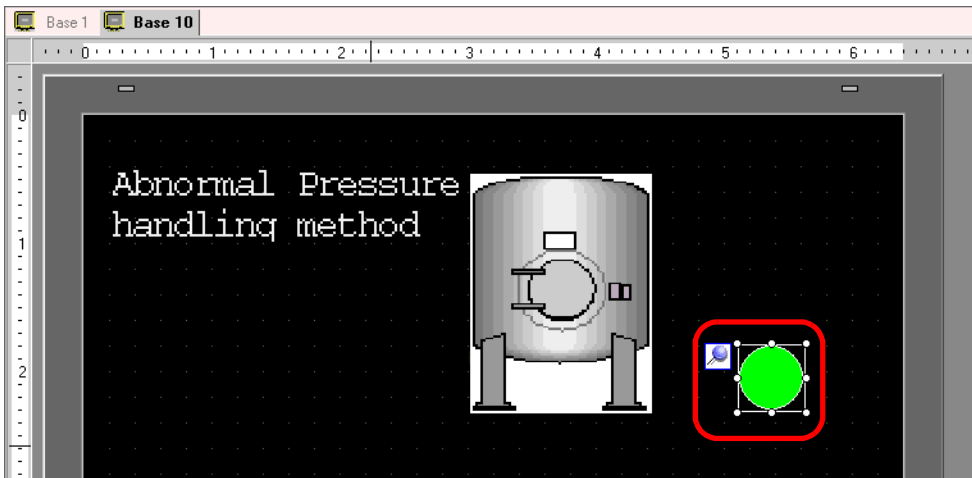

5 Double-click the placed Switchpart and the settings dialog box opens.

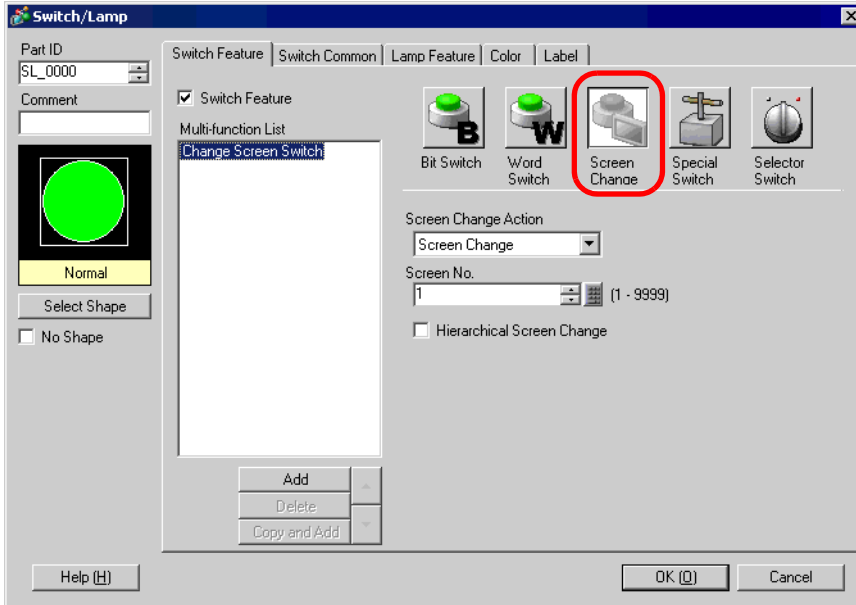

6 Select the Switch's shape from [Select Shape].

7 In [Screen Change Action], select the action to change screens, and set the screen number of the destination screen (e.g.: 1).

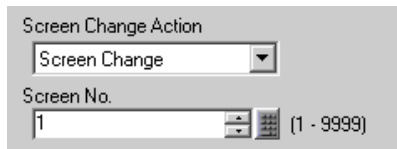

8 As needed, set the Switch's color and display text on the [Color] tab and [Label] tab, and click [OK]. The creation of the Sub Display screen is complete.

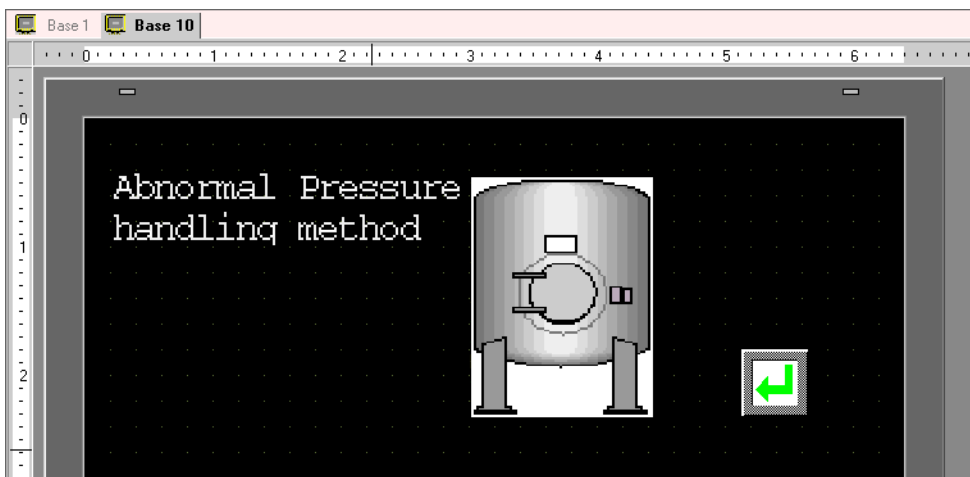

9 Next, register the Message to display when the Alarm is triggered.

Select the [Common Settings (R)] menu - [Alarm Settings (A)] command, or click  to display the following screen. Specify a display language for the Alarm Message in [Language Settings].

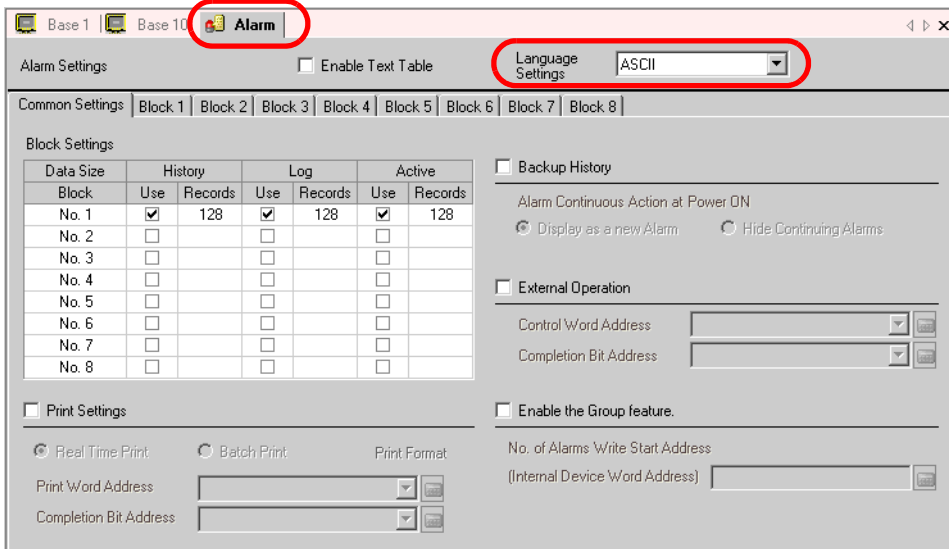

10 On the [Block Settings] tab, check the box for the desired display mode (History/Log/Active) for the block to which the message is registered, and set the number of messages stored as history for each mode.

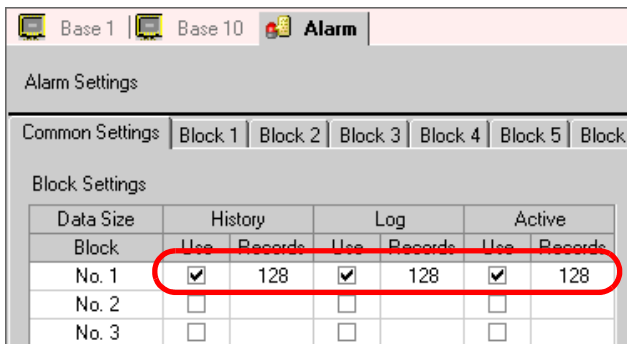

11 Check the [Backup History] box and select [Hide Continuing Alarms].

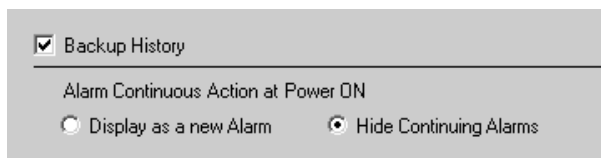

IMPORTANT

- When the [Backup History] box is not checked, the alarm history data will be erased when the GP unit is turned OFF or reset.

12 Open the [Block 1] tab, and select [Bit Monitoring].

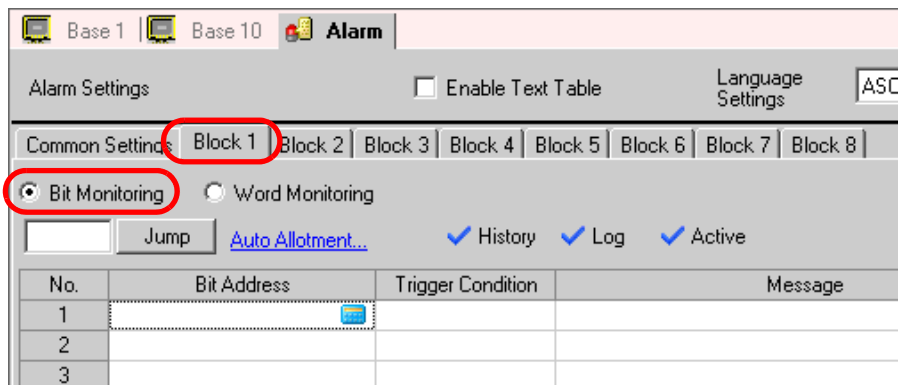

13 In [Bit Address], set the bit address to monitor the alarm's trigger. (e.g.: M1000)

Click the icon to display an address input keypad.

Select device "M", input "1000" as the address, and press the "Ent" key.

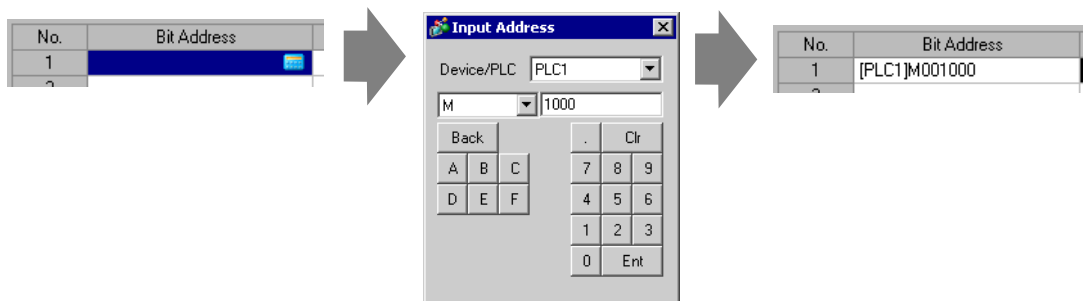

14 Click the [Trigger Condition] cell and select whether the alarm is triggered when the Monitoring Bit Address turns ON or turns OFF.

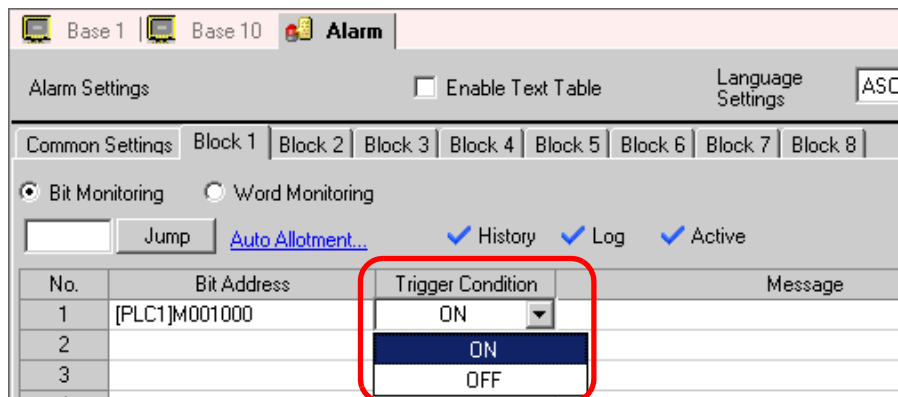

15 In the [Message] cell, input the alarm message that will display when the alarm is triggered.

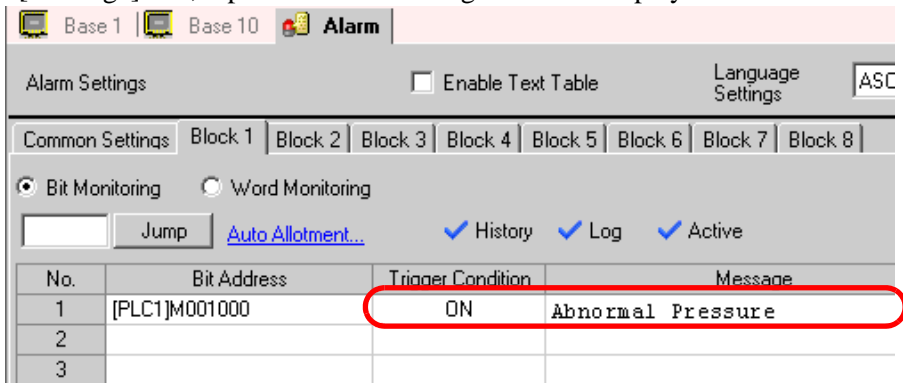

NOTE

- Up to 160 single-byte characters can be registered in a single Alarm Message.
 - When [Enable Text Table] is checked, the message language can be switched and displayed even while the system is running.
- ☞ “15.4 Changing Languages (Multilanguage)” (page 15-15)

16 Set the screen No. of the Sub Display screen. (e.g.: 10)

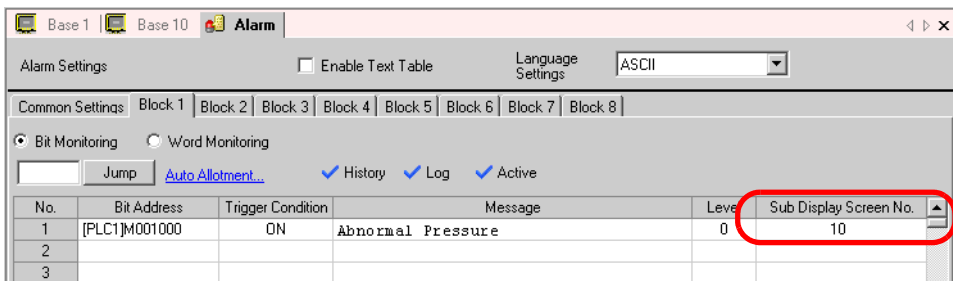

17 Set the Alarm Part that will display the Alarm.

Open the screen to display the Alarm (e.g.: Base 1), and select the [Part (P)] menu - [Alarm (A)] command or click  , and place the Part on the screen.

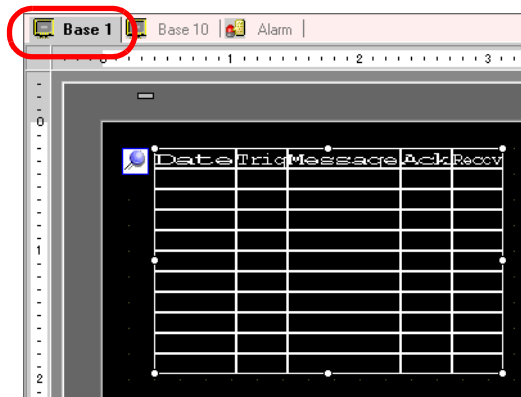

18 Double-click the placed Alarm and the settings dialog box opens.

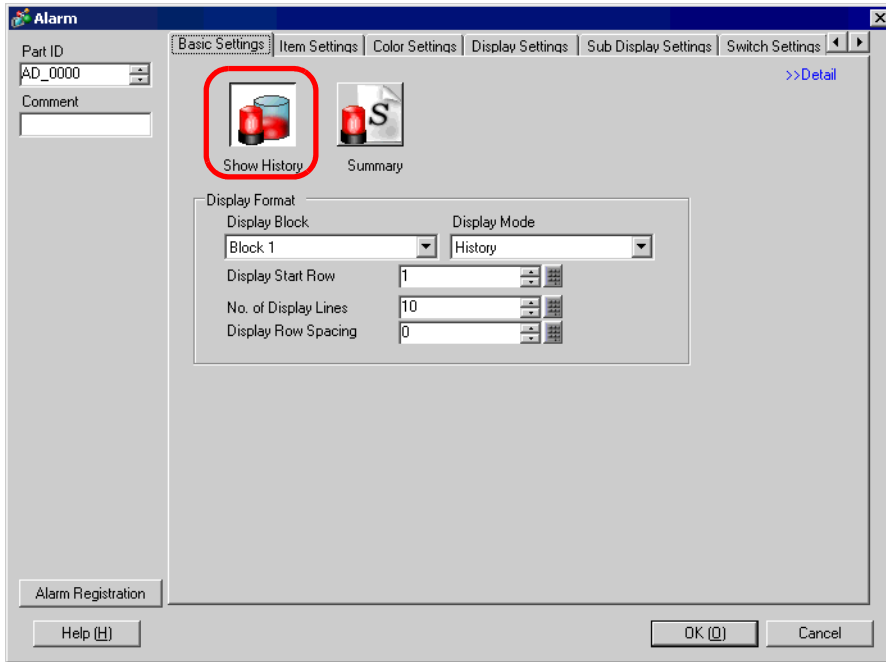

19 Set the block and mode to be displayed for the Alarm.

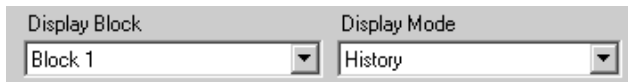

20 Set the [Display Start Row], [No. of Display Lines] and [Display Row Spacing].

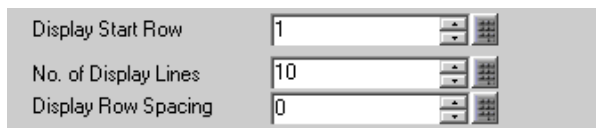

21 Open the [Sub Display Settings] tab, and put a check mark next to the [Enable the Sub Display] box.

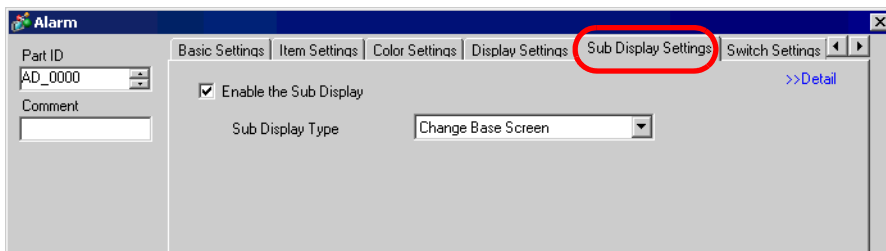

22 Select [Change Base Screen] in the [Sub Display Type] list.

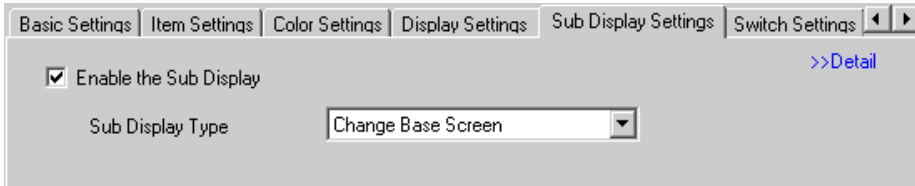

23 As needed, set the number of display characters, text color, background color, font, and size of the alarm message in the [Item Settings] tab, [Color Settings] tab, and [Display Settings] tab. Click [OK].

All settings are now complete.

■ Show Text Window

NOTE

- Please refer to the settings guide for details.
 - ☞ “15.7.2 Common Settings Guide (Text Register)” (page 15-47)
 - ☞ “19.9.1 Alarm Settings Guide ■ Alarm Settings Guide (Block 1)” (page 19-74)
 - ☞ “19.9.2 Alarm Part Settings Guide ■ Show History” (page 19-88)
- For details about placing parts or setting addresses, shapes, colors, and labels, please refer to Editing Parts.
 - ☞ “9.6.1 Editing Parts” (page 9-37)

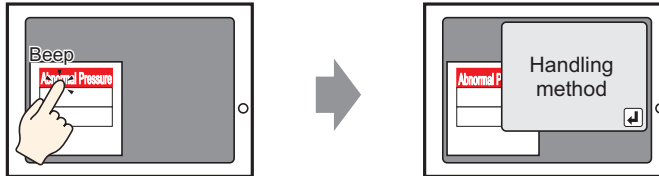

When the alarm message is touched, a Text Window is displayed.

- 1 Create a text window to call a Sub Display. Select the [Common Settings (R)] menu - [Text Registration (T)] command, or click  to display the [New Text/Open] dialog box.
- 2 Set up the Text No. and Comment (Example: Text No. “1”, Comment “Abnormal Pressure”), then click [Create].

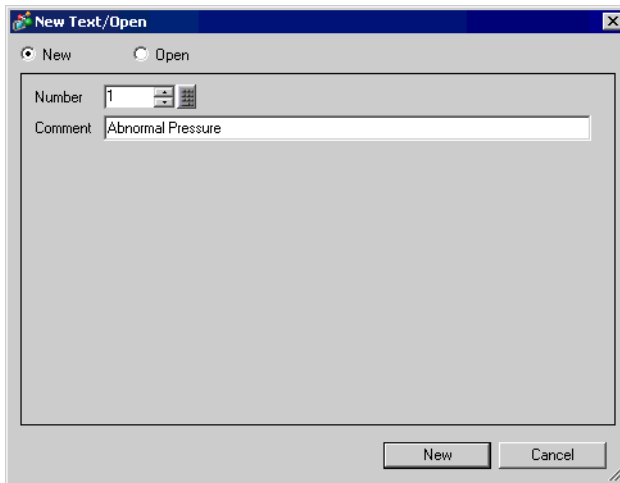

3 Specify [Language], and input the text to be displayed as a Sub Display.

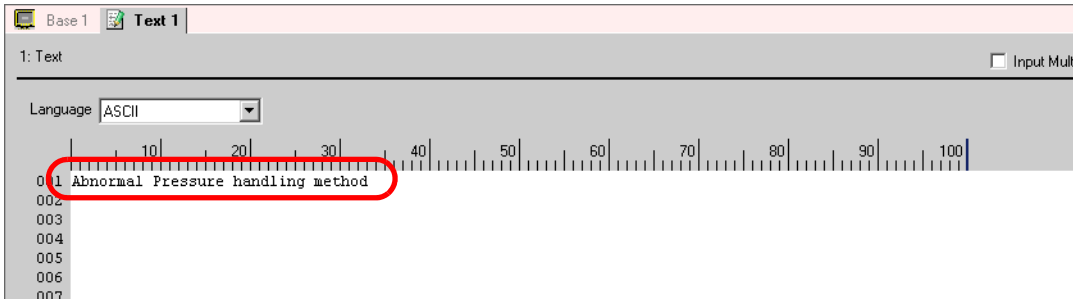

4 Next, register the Message to display when the Alarm is triggered.

Select the [Common Settings (R)] menu - [Alarm Settings (A)] command, or click  to display the following screen. Specify a display language for the Alarm Message in [Language Settings].

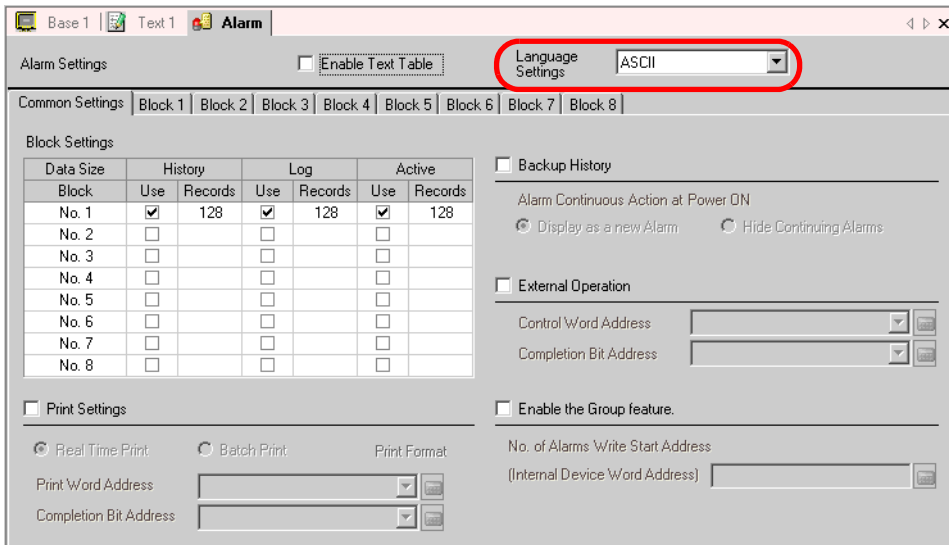

5 On the [Block Settings] tab, check the box for the desired display mode (History/Log/Active) for the block to which the message is registered, and set the number of messages stored as history for each mode.

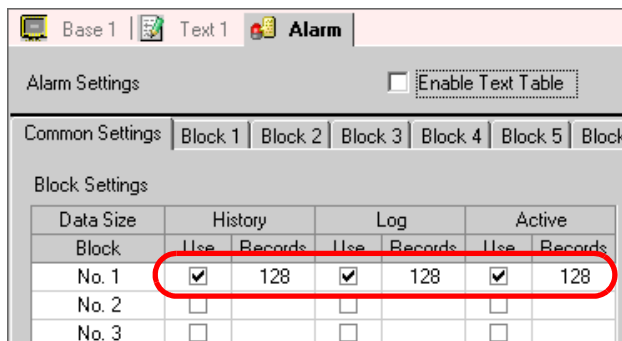

6 Check the [Backup History] box and select [Hide Continuing Alarms].



IMPORTANT

- When the [Backup History] box is not checked, the alarm history data will be erased when the GP unit is turned OFF or reset.

7 Open the [Block 1] tab, and select [Bit Monitoring].

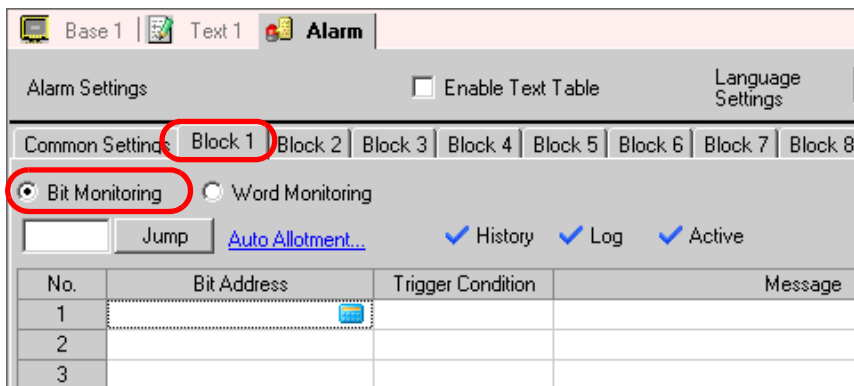

8 In [Bit Address], set the bit address to monitor the alarm's trigger. (e.g.: M1000)

Click the icon to display an address input keypad.

Select device "M", input "1000" as the address, and press the "Ent" key.

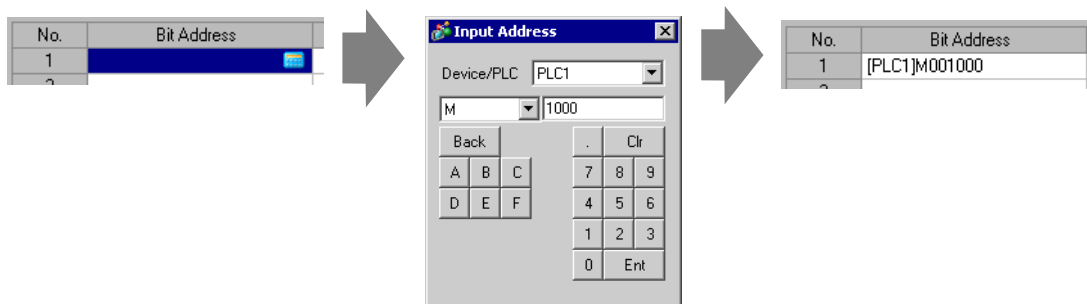

9 Click the [Trigger Condition] cell and select whether the alarm is triggered when the Monitoring Bit Address turns ON or turns OFF.

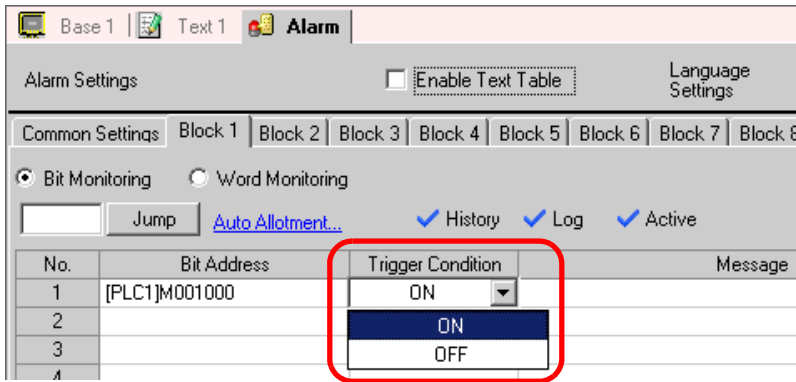

10 In the [Message] cell, input the alarm message that will display when the alarm is triggered.

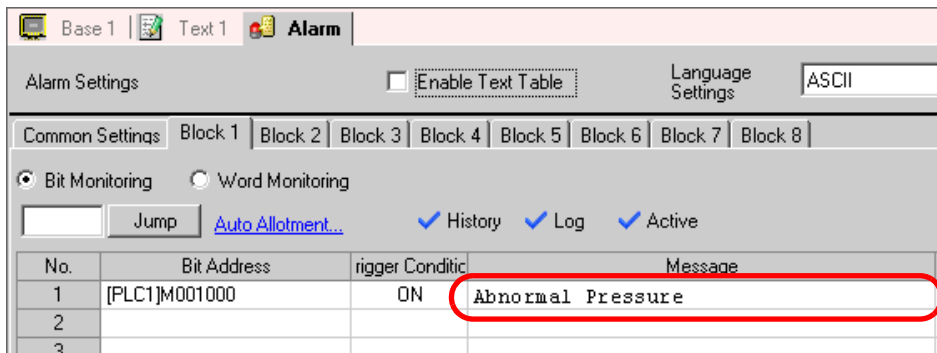

- NOTE**
- Up to 160 single-byte characters can be registered in a single Alarm Message.
 - When [Enable Text Table] is checked, the message language can be switched and displayed even while the system is running.
 ☞ “15.4 Changing Languages (Multilanguage)” (page 15-15)

11 Set the Text No. for the Sub Display to display (e.g.: 1).

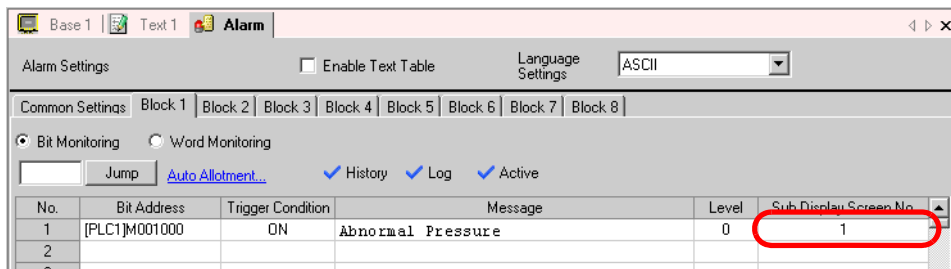

12 Set up the alarm part to display alarms.

Open the screen where you want to display alarms (Example: Base 1), and on the [Parts (P)] menu click [Alarm (A)], or click , then draw the alarm on the screen.

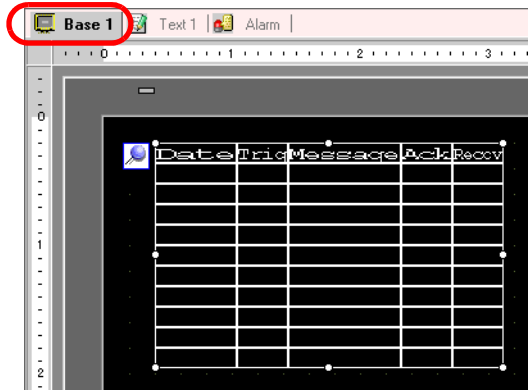

13 Double-click the placed Alarm and the settings dialog box opens.

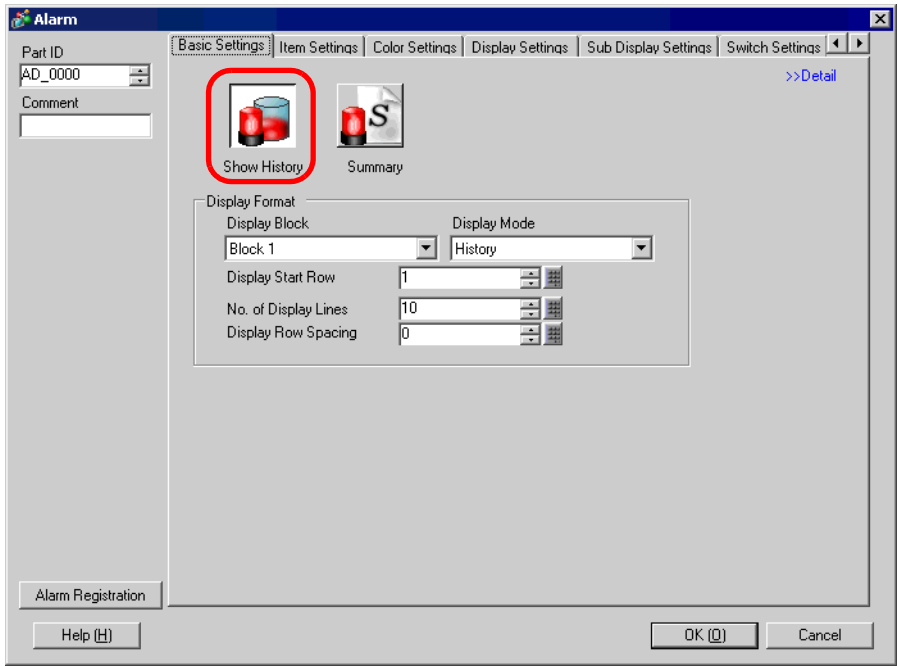

14 Set the block and mode to be displayed for the Alarm.



15 Set the [Display Start Row], [No. of Display Lines] and [Display Row Spacing].

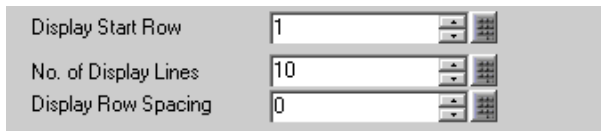

- 16 Click the [Sub Display Settings] tab, and put a check mark next to the [Enable the Sub Display] box.

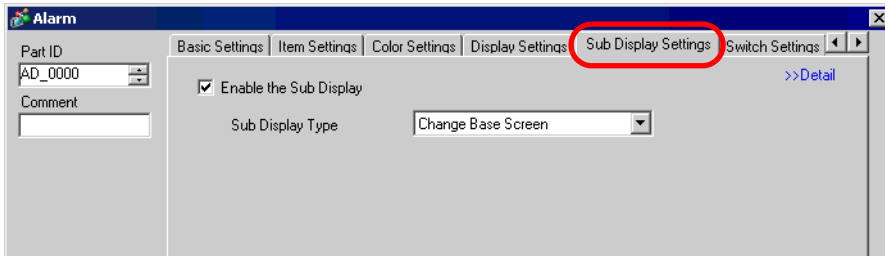

- 17 Select [Show Text Window] in the [Sub Display Type] list.

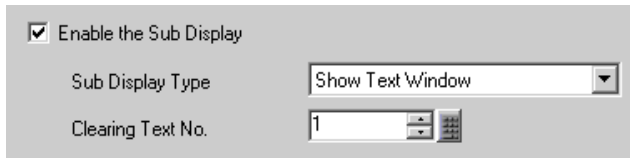

- 18 In [Window Size], select the size of the Window for the Sub Display.



- 19 As needed, set the number of display characters, text color, background color, font, and size of the alarm message in the [Item Settings] tab, [Color Settings] tab, and [Display Settings] tab. Click [OK].

- 20 The position setting mark  is displayed on the upper left of the Alarm Part. Move the position setting mark to the position where you want to display the text window as a Sub Display. All settings are now complete.

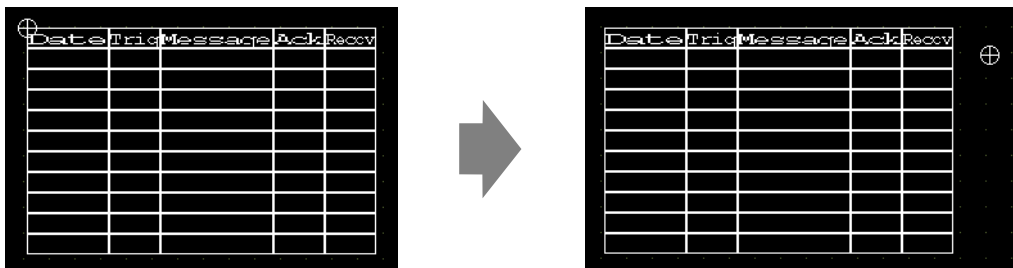

19.7 Viewing Alarms by Line

19.7.1 Details

You can change the Alarms displayed on each screen by registering different Alarm Messages with different production lines.

“Display”

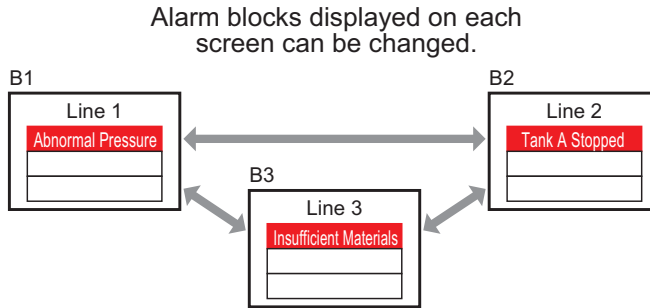

“Register”

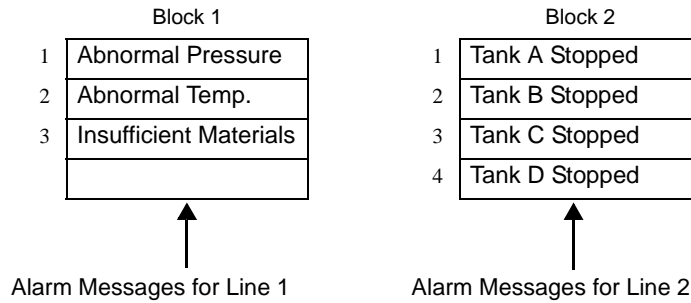

19.7.2 Setup Procedure

NOTE

- Please refer to the settings guide for details.
 - ☞ “19.9.1 Alarm Settings Guide ■ Alarm Settings Guide (Common Settings)” (page 19-64)
 - ☞ “19.9.2 Alarm Part Settings Guide” (page 19-87)
- For details about placing parts or setting addresses, shapes, colors, and labels, please refer to Editing Parts.
 - ☞ “9.6.1 Editing Parts” (page 9-37)

Displays the different blocks' alarm messages on each screen.



- 1 Select the [Common Settings (R)] menu - [Alarm Settings (A)] command, or click  to display the following screen. Specify a display language for the Alarm Message in [Language Settings]

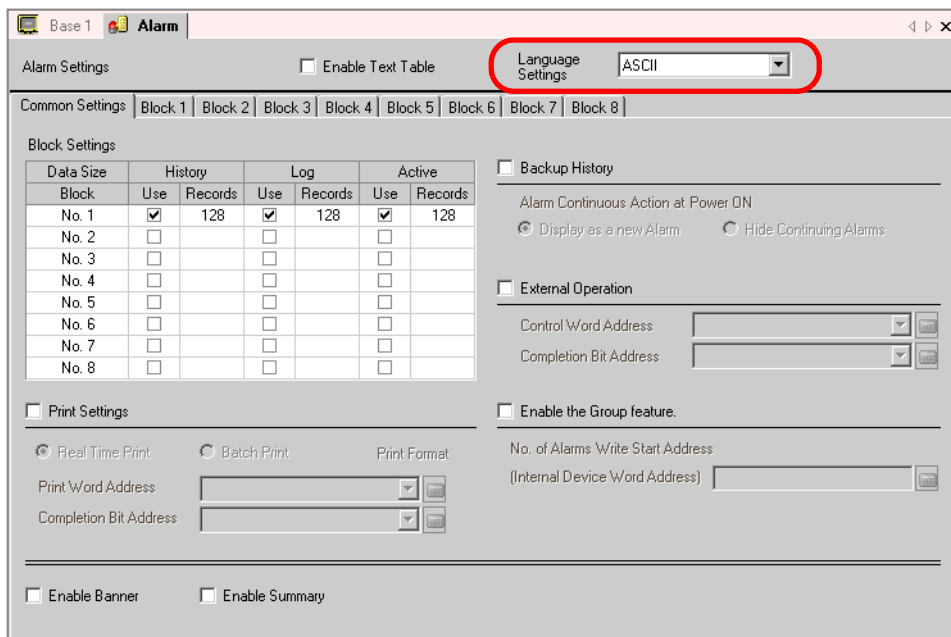

2 On the [Block Settings] tab, select the display mode (History/Log/Active) for each of the blocks to which the messages are registered, and set the number of messages stored as history.

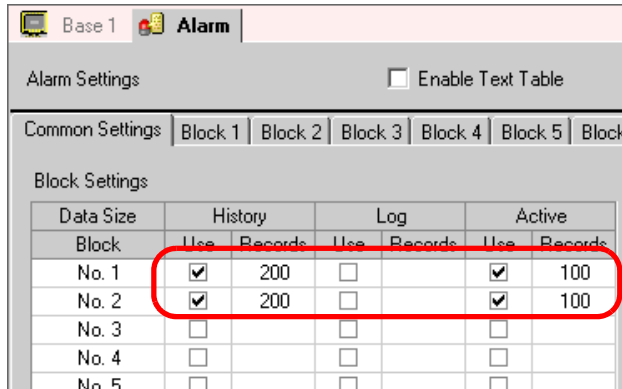

3 Check the [Backup History] box and select [Hide Continuing Alarms].

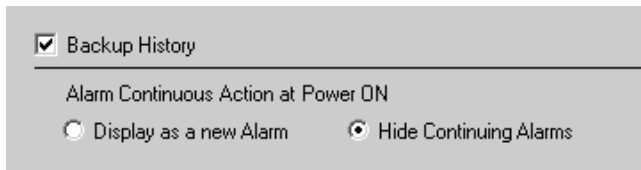

IMPORTANT

- When the [Backup History] box is not checked, the alarm history data will be erased when the GP unit is turned OFF or reset.

4 Open the [Block 1] tab, and select [Bit Monitoring].

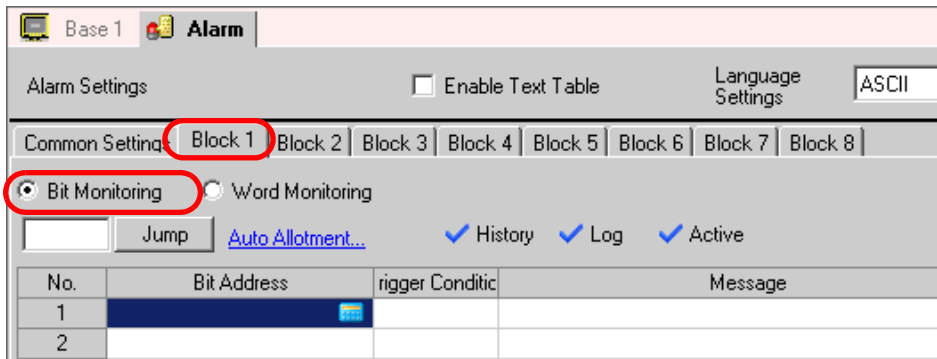

5 In [Bit Address], set the bit address to monitor the alarm's trigger. (e.g.: M1000)

Click the icon to display an address input keypad.

Select device "M", input "1000" as the address, and press the "Ent" key.

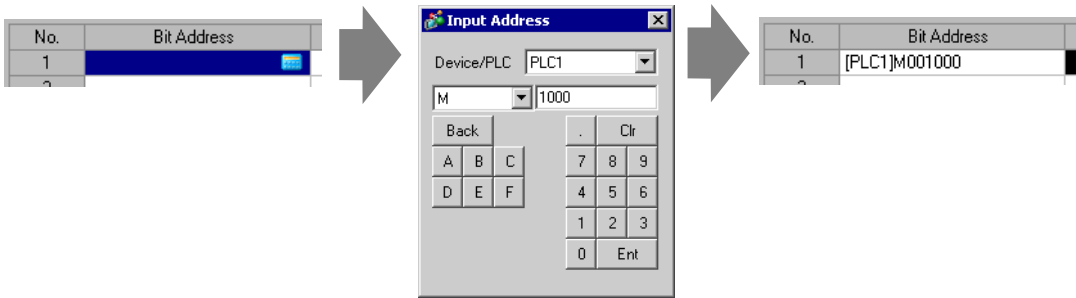

6 Click the [Trigger Condition] cell and select whether the alarm is triggered when the Monitoring Bit Address turns ON or turns OFF.

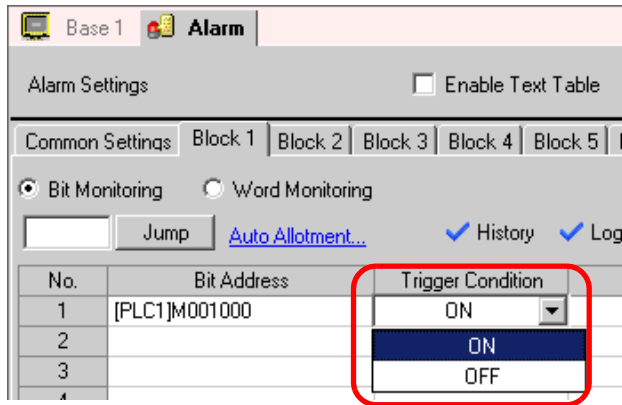

7 In [Message], enter the alarm message of the alarm that occurs in production line 1.

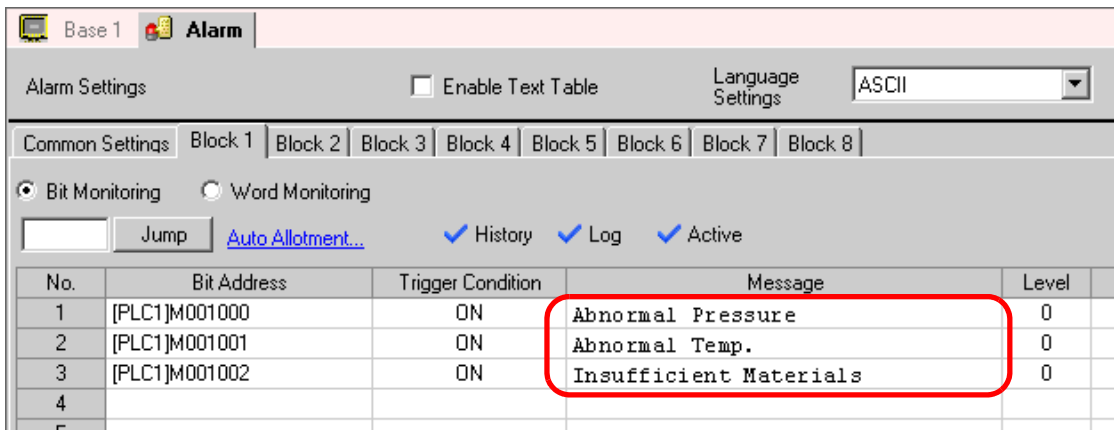

10 Double-click the placed Alarm and the settings dialog box opens.

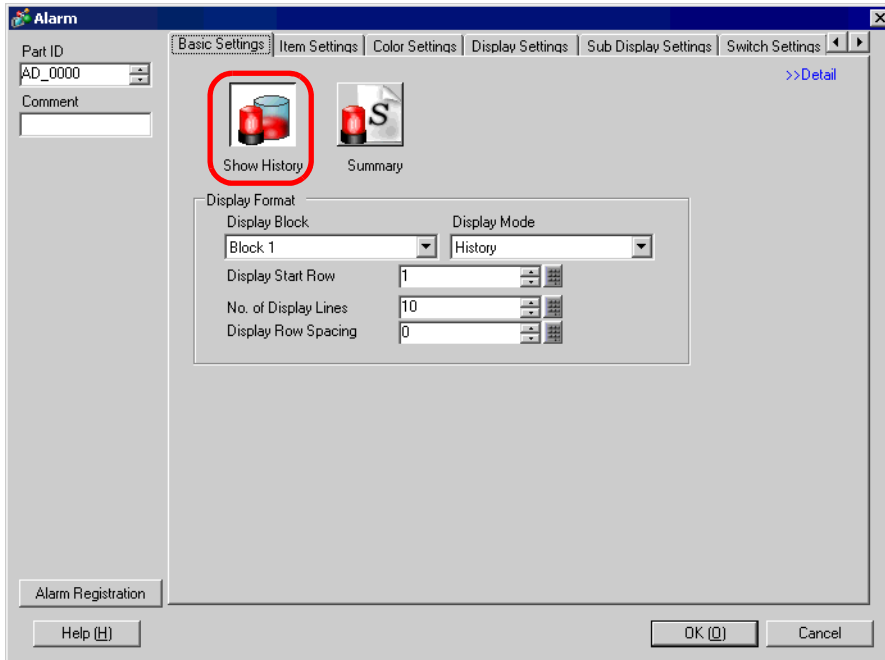

11 In [Display Block] specify [Block 1] and set the Display Mode.



12 Set the [Display Start Row], [No. of Display Lines] and [Display Row Spacing].

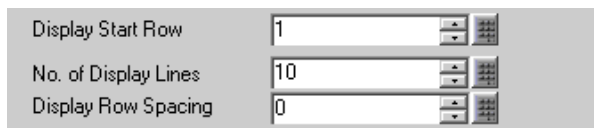

13 As needed, set the number of display characters, text color, background color, font, and size of the alarm message in the [Item Settings] tab, [Color Settings] tab, and [Display Settings] tab. Click [OK].

The creation of the screen to display the Alarm Messages of Block 1 is now complete.

14 Select the [Screen (S)] menu - [New Screen (N)] command, or click , and the [New Screen] dialog box appears. In [Screen No.], set the Base Screen No. (e.g.: 2), and click [New].

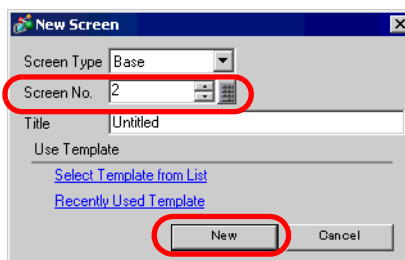

- 15 Select the [Part (P)] menu - [Alarm (A)] command in the [Base 2] screen or click  , and place the Part on the screen.

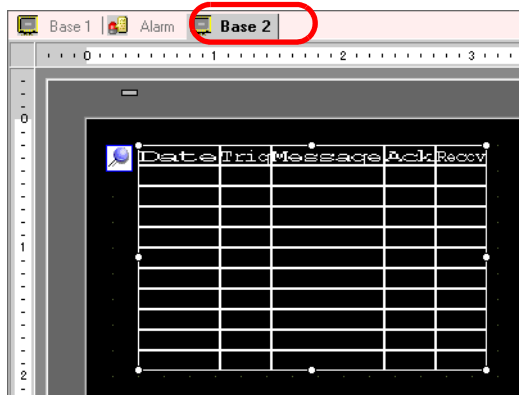

- 16 Double-click the placed Alarm Part to open the settings dialog box, and specify [Block 2] at [Display Block].

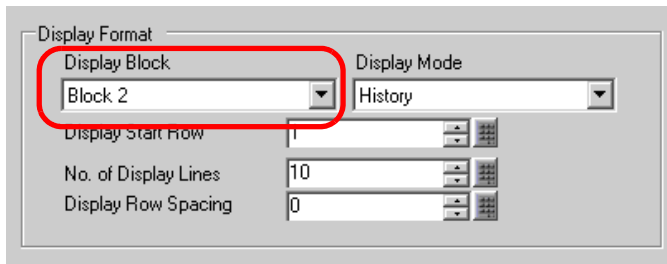

- 17 As needed, set the number of display characters, text color, background color, font, and size of the alarm message in the [Item Settings] tab, [Color Settings] tab, and [Display Settings] tab. Click [OK].

The creation of the screen to display the Alarm Messages of Block 2 is now complete.

19.8 Saving the Alarm History to a CF-Card

19.8.1 Details

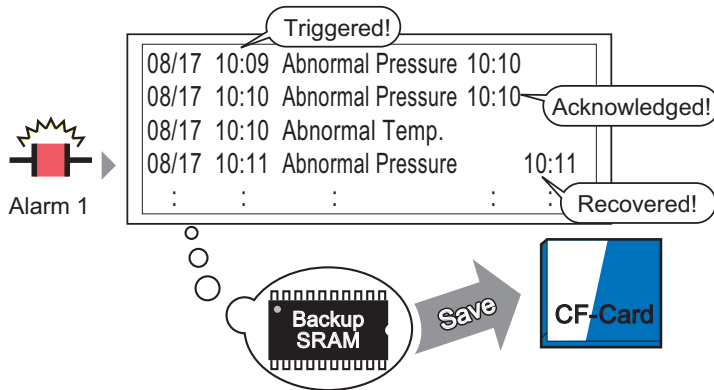

The Alarm History data stored in the backup SRAM is saved to the CF-card.

Save the alarm history data stored in the backup SRAM of the GP to the Save to CF-card. Since the alarm data is saved in CSV format, you can edit the alarm data with a spreadsheet application, such as Microsoft Excel.

-
- NOTE** • If there is not enough free space on the CF Card, allocate more disk space by moving non-urgent data to USB memory.
 ☞ "A.4 Transferring Data Between a CF Card and a USB Memory Device" (page A-66)
-

19.8.2 Setup Procedure

NOTE

- Please refer to the settings guide for details.
 - ☞ “19.9.1 Alarm Settings Guide ■ Alarm Settings Guide (Common Settings)” (page 19-64)
 - ☞ “5.13.6 [System Settings Window] Settings Guide ■ [Main Unit Settings] Settings Guide ◆ Operation Settings” (page 5-103)

Configure settings to write the Alarm History data stored in the backup SRAM to the CF-Card in CSV format.

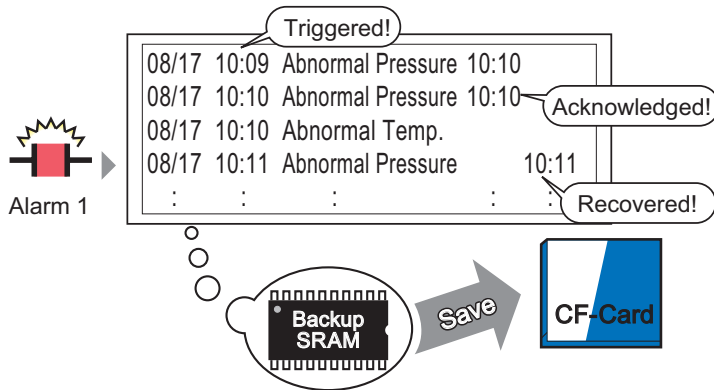

The Alarm History data stored in the backup SRAM is saved to the CF-card.

1 Click [Main Unit Settings] in the System Settings Window and open the [Action Settings] tab.

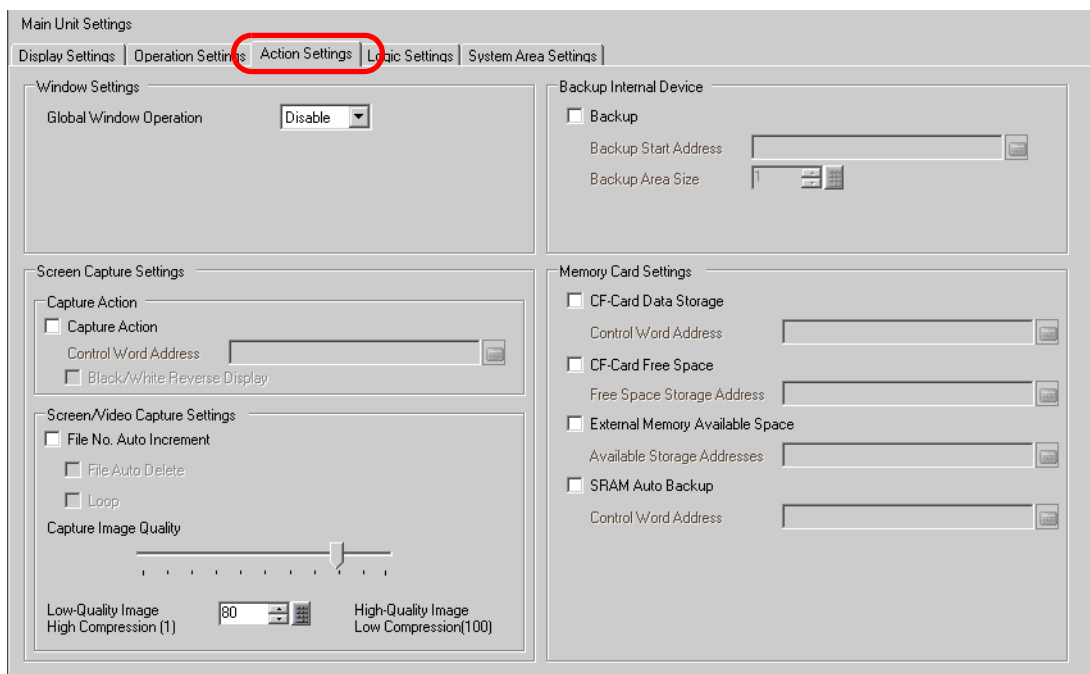

2 In the [Memory Card Settings] area select the [CF-Card Data Storage] check box.

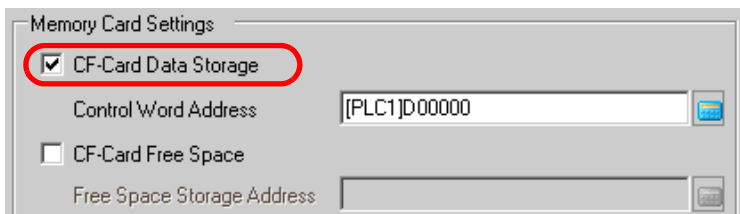

3 In [Control Word Address], set the address used to control the writing of data to the CF-Card (e.g.: D100).

Click the icon to display an address input keypad.

Select the address to device “D”, input “100” and press the “Ent” key.



4 The settings for writing Alarm History data to the CF-Card are now complete.

- NOTE**
- The CSV storage format is determined by the [Display Mode] setting. The setting is checked in the order of [History] → [Log] → [Active], and data is output in the format of the first [Display Mode] set [On]. e.g.: When the data of Block 1 is saved to the CF-Card

Common Settings							
Block Settings							
Block	Data Size	History		Log		Active	
		Use	Records	Use	Records	Use	Records
No. 1		<input checked="" type="checkbox"/>	100	<input checked="" type="checkbox"/>	100	<input type="checkbox"/>	
No. 2		<input type="checkbox"/>		<input type="checkbox"/>		<input type="checkbox"/>	

In this case, the data is saved in [History] format. If [History] were not set, the data would be saved using [Log] format.

- Data is output with the latest information at the top regardless of the display mode.

Item names such as [Trigger Date], [Trigger Time], or [Message] are fixed. These names are displayed in Japanese when the language is Japanese, but if any other language is used (Western, Korean, Chinese (Traditional), Chinese (Simplified), Cyrillic, Thai), the items will be in English.

19.8.3 Structure

■ Saving data to the CF-Card

To save data to the CF-Card, manage the designated control word address as follows.

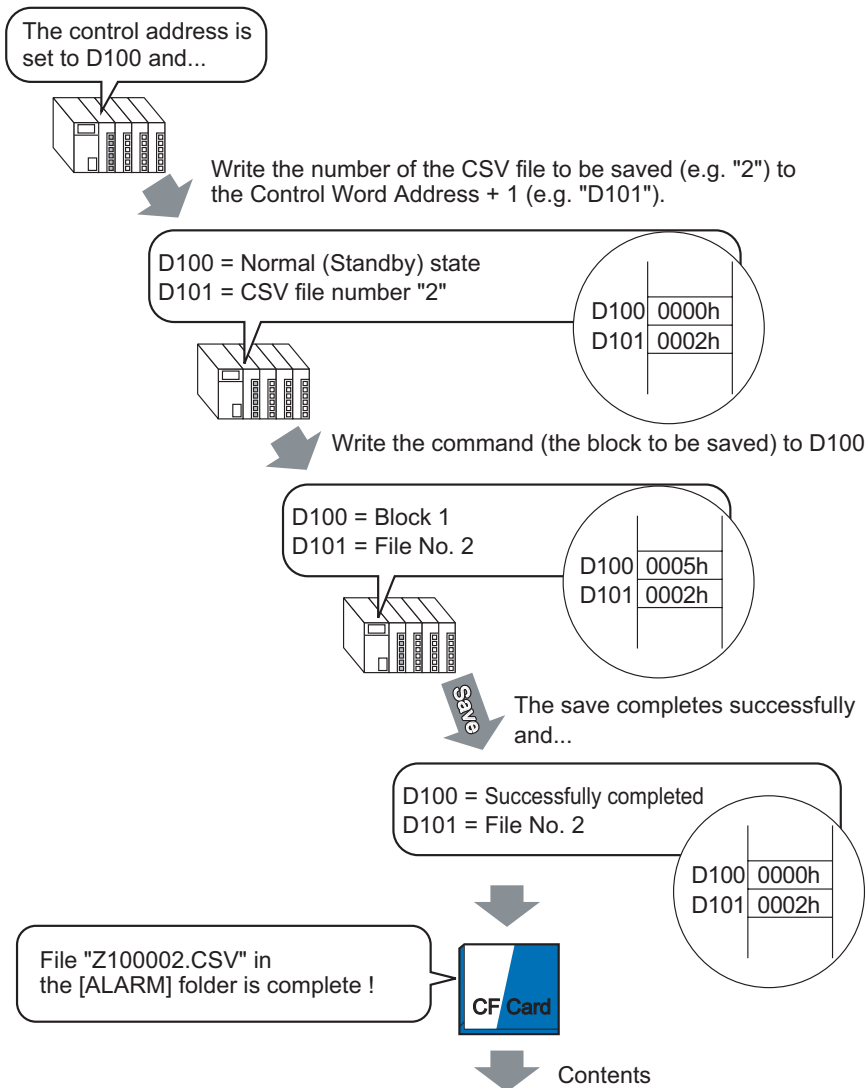

```
"No. of Message(s)","3","","",""
"" "" "" "" ""
"Trigger Date","Trigger Time","Message(s)","Acknowledge Time","Recovery Time","No. of occ.,""Acc. Time","Level"
"05/11/14","10:05:35","B Tank - Abnormal Pressure","10:20:35","11:00:15","1","1:00:00","1"
"05/11/13","12:15:00","A Tank - Low Water Level","13:20:00","16:15:00","2","03:00:00","0"
"05/11/13","12:00:10","Pump No. 1 Closed","14:00:20","16:50:30","1","4:50:20","2"
```

↓ When this data is opened in Microsoft Excel ...

No. of Message(s)	Trigger Date	Trigger Time	Message(s)	Acknowledge Time	Recovery Time	No. of occ.	Acc. Time	Level
3	2005/11/14	10:05:35	B Tank - Abnormal Pressure	10:20:35	11:00:15	1	1:00:00	1
	2005/11/13	12:15:00	A Tank - Low Water Level	13:20:00	16:15:00	2	3:00:00	0
	2005/11/13	12:00:10	Pump No. 1 Closed	14:00:20	16:50:30	1	4:50:20	2

■ **Control Word Address for saving data to the CF-Card**

This address controls the writing of data to the CF-Card. After designating a file number, write the command to the address.

Control Word Address	Command/Status
+1	File Number

◆ **Command and Status**

Write the command, and the data is written to the CF-Card. The operation result (status) is reflected in the address.

Mode	Word Data	Description
Command	0001h	Filing Data
	0002h	GP-PRO/PB III for Windows Logging data (compatible)
	0003h	GP-PRO/PB III for Windows Line Chart data (compatible)
	0004h	GP-PRO/PB III for Windows Sampling data (compatible)
	0005h	Block 1's Alarm History data
	0006h	Block 2's Alarm History data
	0007h	Block 3's Alarm History data
	0008h	Block 4's Alarm History data
	0009h	Block 5's Alarm History data
	000000ah	Block 6's Alarm History data
	000000bh	Block 7's Alarm History data
	000000ch	Block 8's Alarm History data
	0020h	GP-PRO/PB III for Windows Logging loop auto-save start (compatible)
	0021h	GP-PRO/PB III for Windows Logging loop auto-save completion (compatible)
Status	0000h	Completed Successfully
	0100h	Write Error
	0200h	No CF-Card is inserted, or the cover is open.
	0300h	No data to be loaded (when no data is specified)
	0400h	File No. Error (File number is outside of range)
	2000h	GP-PRO/PB III for Windows Logging loop auto-save responding correctly (compatible) Control Address becomes this value during the auto-save mode. When the value is changed, the auto-save mode finishes.

◆ **File Name and Save Location**

Designate a file number from 0 to 65,535 in the address following the control word address prior to writing a command.

After writing a command, Alarm History data will be saved to the CF-Card's [ALARM] folder with the following file name.

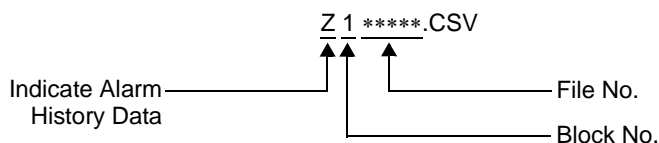

e.g.)

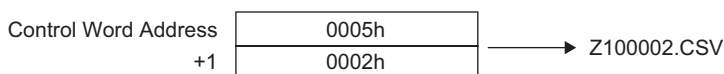

NOTE • When the CF-Card is reset by the GP unit, a folder will automatically be created to save data.

Folder	Data to be saved	File Name
\FILE	Filing Data	F*****.BIN
	Transfer CSV Data	ZR*****.CSV
\LOG	GP-PRO/PB III for Windows Logging data (compatible)	ZL*****.CSV
\DATA	Image Screen	I*****.BIN
	Sound Data	O*****.BIN
\CAPTURE	Screen Capture Video Capture	CP*****.JPG
\MOVIE	Movie File	*.SDX
\TREND	GP-PRO/PB III for Windows Line Chart data (compatible)	ZT*****.CSV
	GP-PRO/PB III for Windows Sampling data (compatible)	ZS*****.CSV
\ALARM	Block 1's Alarm History data	Z1*****.CSV
	Block 2's Alarm History data	Z2*****.CSV
	Block 3's Alarm History data	Z3*****.CSV
	Block 4's Alarm History data	Z4*****.CSV
	Block 5's Alarm History data	Z5*****.CSV
	Block 6's Alarm History data	Z6*****.CSV
	Block 7's Alarm History data	Z7*****.CSV
	Block 8's Alarm History data	Z8*****.CSV
\SRAM	Backup SRAM data	ZD*****.BIN
\SAMP01	Sampling Group 1's data	SA*****.CSV
• • •	• • •	
\SAMP64	Sampling Group 64's data	SA*****.CSV

■ Caution when saving data to the CF-Card

- While data is being written to the CF-Card, changes of parts and screens may slow down.
- It may take several seconds to write data, depending on the amount.
- After the Status data is read out from the GP, before the next command can be written be sure to allow time equal to at least one communication cycle ^{*1} or one Display Scan Time period, ^{*2} whichever is longer.
- Please do not call up screens that use the CF-Card when it is not installed in the GP. Otherwise, they will not function properly.
- If a write error occurs, any file that has not finished loading may remain on the CF-Card.
- When overwriting a file by transferring data to the CF-Card, the CF-Card must have enough free room to allow the data. If the data is larger than the available space, a write error will occur.
- When data is saved to the CF-Card and the target folder (e.g.: \ALARM) does not exist, the [ALARM] folder will be automatically created to save the data. However, if the folder cannot be created because the CF-Card has not been reset or other reasons, a write error will occur.
- There is a limit to the frequency that data can be written to the CF-Card (500 KB of data can be rewritten around 100,000 times).

■ Precautions when handling CF-Cards

- When removing the CF-Card, please verify that the access lamp is switched off. There is a chance that CF-Card data can be lost or damaged.
- While accessing the CF-Card, do not turn the GP unit off, reset the GP, or remove the CF-Card. Create a preset verification screen for information about CF-Card access. Turn off power, reset, open the CF-Card cover, or remove the CF-Card only after verifying that screen.
- When inserting the CF-Card in the GP unit, please make sure you have the correct side up and the correct location for the CF-Card connector. If installed incorrectly, damage can occur to the data or to the CF-Card/GP unit.
- Please use a CF-Card made by Pro-face. If using another company's CF-Card, damage may occur to the CF-Card's data.
- Please make sure to back up all CF-Card data.
- Please refrain from doing the following, as it can result in damage to data and equipment:
 - Bending the CF-Card
 - Dropping the CF-Card
 - Spilling water on the card
 - Touching the CF-Card's connectors directly
 - Disassembling or modifying the CF-Card

*1 The communication cycle time is the time it takes to request and take in data from the GP unit to the PLC. It is stored in the internal device's LS2037 as binary data. The unit is 10 ms.

*2 Display Scan Time is the time it takes to display/calculate 1 screen. It is stored in the internal device's LS2036 as binary data. The unit is milliseconds (ms).

19.9 Settings Guide

19.9.1 Alarm Settings Guide

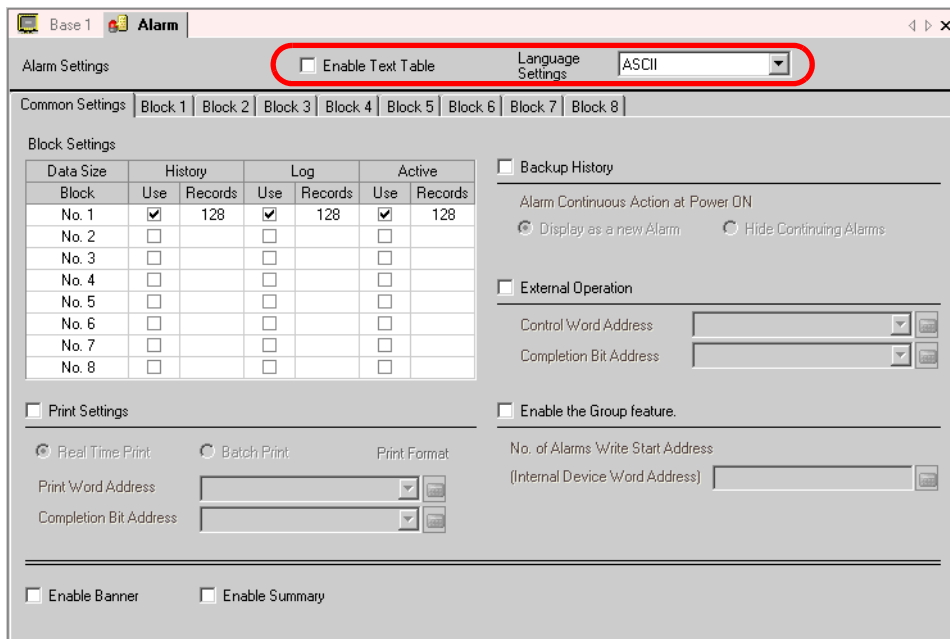

Setting	Description
Enable Text Table	Specify whether to use the character string registered in the text table for alarm messages. The language of alarm messages can be changed while the system is running. ☞ “15.7.7 Alarm Settings (Enable Text Table) Settings Guide” (page 15-58)
Language Settings	When entering messages without using the Text Table, select the language of the alarm message as [Japanese], [Western], [Chinese (Traditional)], [Chinese (Simplified)], [Korean], [Cyrillic], or [Thai].

NOTE

- The setting of the text table or language is common to all alarm settings (History, Banner, Summary). When the selection of [Language Setting] is changed to [Enable Text Table] and vice versa, the messages which have been set are deleted.

■ Alarm Settings Guide (Common Settings)

You can set the block, display mode, and the number of Alarm Histories stored for Alarm Message (History).

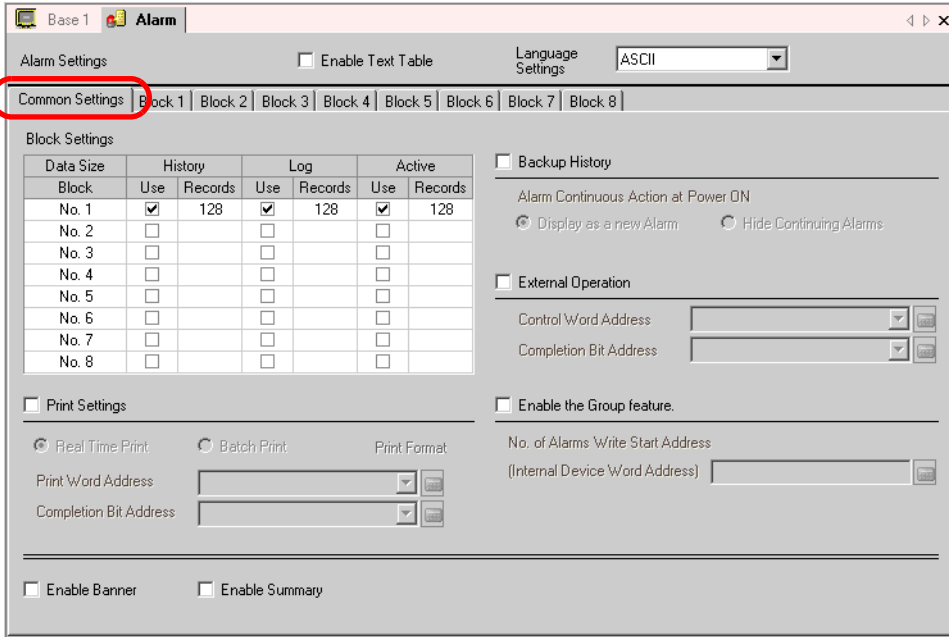

Setting	Description
Block Settings	Set the display mode and the number of Alarm History records (the number of Alarm Histories stored in the GP) in each mode for each block. A maximum of 768 Alarm Histories can be set.
Block	A group of Alarm Messages to be registered. A maximum of 8 blocks can be used.

Continued

Setting	Description																																																																																									
Block Settings Display Mode	<p>Choose the Alarm Message's display method from [History], [Log], or [Active]. Choose [Active] to display only alarms which are currently triggered. To save old alarms choose [History] or [Log].</p> <table border="1" data-bbox="430 311 1260 664"> <tr> <td data-bbox="430 311 581 490" rowspan="4">[History]</td> <td colspan="5" data-bbox="581 311 1260 490">Displays Alarm Messages together with the trigger date and time in the order they are triggered. The time at which the Alarm is acknowledged or recovered will be added to the same row. The change in the state of each Alarm can be viewed on a single row.</td> </tr> <tr> <td data-bbox="581 490 705 537">Date</td> <td data-bbox="705 490 801 537">Trigger Time</td> <td data-bbox="801 490 1048 537">Message</td> <td data-bbox="1048 490 1144 537">Acknowledge Time</td> <td data-bbox="1144 490 1260 537">Recovery time</td> </tr> <tr> <td data-bbox="581 537 705 575">2003/12/13</td> <td data-bbox="705 537 801 575">20:14</td> <td data-bbox="801 537 1048 575">Conveyor Stopped</td> <td data-bbox="1048 537 1144 575"></td> <td data-bbox="1144 537 1260 575"></td> </tr> <tr> <td data-bbox="581 575 705 622">2003/12/13</td> <td data-bbox="705 575 801 622">20:02</td> <td data-bbox="801 575 1048 622">Hopper Capacity Reduced</td> <td data-bbox="1048 575 1144 622">20:08</td> <td data-bbox="1144 575 1260 622"></td> </tr> <tr> <td data-bbox="581 622 705 664">2003/12/13</td> <td data-bbox="705 622 801 664">19:30</td> <td data-bbox="801 622 1048 664">Abnormal Voltage</td> <td data-bbox="1048 622 1144 664">19:40</td> <td data-bbox="1144 622 1260 664">20:00</td> </tr> </table> <table border="1" data-bbox="430 683 1260 1108"> <tr> <td data-bbox="430 683 581 1108" rowspan="6">[Log]</td> <td colspan="5" data-bbox="581 683 1260 819">The messages and date/time are displayed in separate rows every time the state changes from [Trigger], [Acknowledge], to [Recovery]. Date of every state can be checked.</td> </tr> <tr> <td data-bbox="581 819 705 865">Date</td> <td data-bbox="705 819 801 865">Trigger Time</td> <td data-bbox="801 819 1048 865">Message</td> <td data-bbox="1048 819 1144 865">Acknowledge Time</td> <td data-bbox="1144 819 1260 865">Recovery time</td> </tr> <tr> <td data-bbox="581 865 705 911">2003/12/13</td> <td data-bbox="705 865 801 911">20:14</td> <td data-bbox="801 865 1048 911">Conveyor Stopped</td> <td data-bbox="1048 865 1144 911"></td> <td data-bbox="1144 865 1260 911"></td> </tr> <tr> <td data-bbox="581 911 705 958">2003/12/13</td> <td data-bbox="705 911 801 958"></td> <td data-bbox="801 911 1048 958">Hopper Capacity Reduced</td> <td data-bbox="1048 911 1144 958">20:08</td> <td data-bbox="1144 911 1260 958"></td> </tr> <tr> <td data-bbox="581 958 705 1004">2003/12/13</td> <td data-bbox="705 958 801 1004">20:02</td> <td data-bbox="801 958 1048 1004">Hopper Capacity Reduced</td> <td data-bbox="1048 958 1144 1004"></td> <td data-bbox="1144 958 1260 1004"></td> </tr> <tr> <td data-bbox="581 1004 705 1051">2003/12/13</td> <td data-bbox="705 1004 801 1051"></td> <td data-bbox="801 1004 1048 1051">Abnormal Voltage</td> <td data-bbox="1048 1004 1144 1051"></td> <td data-bbox="1144 1004 1260 1051">20:00</td> </tr> <tr> <td data-bbox="581 1051 705 1097">2003/12/13</td> <td data-bbox="705 1051 801 1097"></td> <td data-bbox="801 1051 1048 1097">Abnormal Voltage</td> <td data-bbox="1048 1051 1144 1097">19:40</td> <td data-bbox="1144 1051 1260 1097"></td> </tr> <tr> <td data-bbox="581 1097 705 1143">2003/12/13</td> <td data-bbox="705 1097 801 1143">19:30</td> <td data-bbox="801 1097 1048 1143">Abnormal Voltage</td> <td data-bbox="1048 1097 1144 1143"></td> <td data-bbox="1144 1097 1260 1143"></td> </tr> </table> <table border="1" data-bbox="430 1186 1260 1379"> <tr> <td data-bbox="430 1186 581 1379" rowspan="4">[Active]</td> <td colspan="4" data-bbox="581 1186 1260 1244">Only [Trigger] and [Acknowledge] alarms are displayed. When an alarm recovers, it is automatically erased.</td> </tr> <tr> <td data-bbox="581 1244 705 1290">Date</td> <td data-bbox="705 1244 801 1290">Trigger Time</td> <td data-bbox="801 1244 1048 1290">Message</td> <td data-bbox="1048 1244 1260 1290">Acknowledge Time</td> </tr> <tr> <td data-bbox="581 1290 705 1336">2003/12/13</td> <td data-bbox="705 1290 801 1336">20:14</td> <td data-bbox="801 1290 1048 1336">Conveyor Stopped</td> <td data-bbox="1048 1290 1260 1336"></td> </tr> <tr> <td data-bbox="581 1336 705 1379">2003/12/13</td> <td data-bbox="705 1336 801 1379">20:02</td> <td data-bbox="801 1336 1048 1379">Hopper Capacity Reduced</td> <td data-bbox="1048 1336 1260 1379"></td> </tr> <tr> <td data-bbox="581 1379 705 1425">2003/12/13</td> <td data-bbox="705 1379 801 1425">19:30</td> <td data-bbox="801 1379 1048 1425">Abnormal Voltage</td> <td data-bbox="1048 1379 1260 1425">19:40</td> <td data-bbox="1144 1379 1260 1425"></td> </tr> </table>	[History]	Displays Alarm Messages together with the trigger date and time in the order they are triggered. The time at which the Alarm is acknowledged or recovered will be added to the same row. The change in the state of each Alarm can be viewed on a single row.					Date	Trigger Time	Message	Acknowledge Time	Recovery time	2003/12/13	20:14	Conveyor Stopped			2003/12/13	20:02	Hopper Capacity Reduced	20:08		2003/12/13	19:30	Abnormal Voltage	19:40	20:00	[Log]	The messages and date/time are displayed in separate rows every time the state changes from [Trigger], [Acknowledge], to [Recovery]. Date of every state can be checked.					Date	Trigger Time	Message	Acknowledge Time	Recovery time	2003/12/13	20:14	Conveyor Stopped			2003/12/13		Hopper Capacity Reduced	20:08		2003/12/13	20:02	Hopper Capacity Reduced			2003/12/13		Abnormal Voltage		20:00	2003/12/13		Abnormal Voltage	19:40		2003/12/13	19:30	Abnormal Voltage			[Active]	Only [Trigger] and [Acknowledge] alarms are displayed. When an alarm recovers, it is automatically erased.				Date	Trigger Time	Message	Acknowledge Time	2003/12/13	20:14	Conveyor Stopped		2003/12/13	20:02	Hopper Capacity Reduced		2003/12/13	19:30	Abnormal Voltage	19:40	
	[History]		Displays Alarm Messages together with the trigger date and time in the order they are triggered. The time at which the Alarm is acknowledged or recovered will be added to the same row. The change in the state of each Alarm can be viewed on a single row.																																																																																							
			Date	Trigger Time	Message	Acknowledge Time	Recovery time																																																																																			
2003/12/13			20:14	Conveyor Stopped																																																																																						
2003/12/13		20:02	Hopper Capacity Reduced	20:08																																																																																						
2003/12/13	19:30	Abnormal Voltage	19:40	20:00																																																																																						
[Log]	The messages and date/time are displayed in separate rows every time the state changes from [Trigger], [Acknowledge], to [Recovery]. Date of every state can be checked.																																																																																									
	Date	Trigger Time	Message	Acknowledge Time	Recovery time																																																																																					
	2003/12/13	20:14	Conveyor Stopped																																																																																							
	2003/12/13		Hopper Capacity Reduced	20:08																																																																																						
	2003/12/13	20:02	Hopper Capacity Reduced																																																																																							
	2003/12/13		Abnormal Voltage		20:00																																																																																					
2003/12/13		Abnormal Voltage	19:40																																																																																							
2003/12/13	19:30	Abnormal Voltage																																																																																								
[Active]	Only [Trigger] and [Acknowledge] alarms are displayed. When an alarm recovers, it is automatically erased.																																																																																									
	Date	Trigger Time	Message	Acknowledge Time																																																																																						
	2003/12/13	20:14	Conveyor Stopped																																																																																							
	2003/12/13	20:02	Hopper Capacity Reduced																																																																																							
2003/12/13	19:30	Abnormal Voltage	19:40																																																																																							
Use	Select the [Display Mode] to be used. A total of 8 display modes at maximum can be set for the whole Alarm History.																																																																																									
Records	Set the number of Alarm Histories stored for each display mode. Up to 768 Alarm Histories can be set in total. When triggered alarms exceed the specified number, the oldest alarm is deleted.																																																																																									

Continued

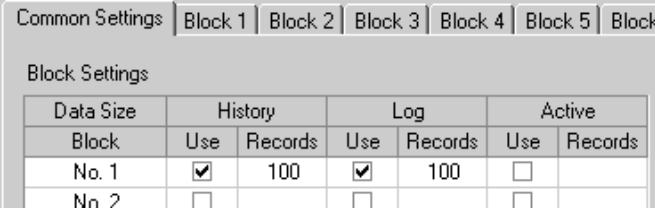
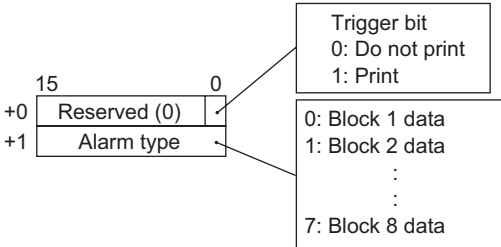
Setting	Description
Print Settings	Select whether or not to print the Alarm History. ☞ “19.10.1 Restrictions for Printing Alarm History” (page 19-142)
Real Time Print/ Batch Print	<p>Choose the printing timing from [Real Time Print] or [Batch Print].</p> <ul style="list-style-type: none"> • Real-Time Print Alarm history is printed every time a [Trigger], [Acknowledge], and [Recovery] occurs. The print format is the same as the display format of [Log]. Even when two or more blocks are used, printing is performed as occasion arises regardless of the block. • Batch Print When the bit 0 in [Print Word Address] is turned ON, the whole Alarm Histories stored in the designated block are printed. The print format is decided by the block’s [Display Mode] setting. The order is listed as [History]→[Log] → [Active] and data is printed in the format of the first [Display Mode] set [On]. e.g.: When printing block 1  <p>In this case, the block is printed using [History] format. If [History] were not set, the block would be printed using [Log] format. A page feed will occur after printing.</p>
Print Word Address	<p>This address controls the printing of the Alarm History. After setting the type of alarm, turn ON the trigger bit (bit 0) to start printing.</p> 
Completion Bit Address	<p>Set the bit address that will tell you when printing has completed. This bit will turn ON when printing finishes.</p> <p>NOTE</p> <ul style="list-style-type: none"> • After the [Completion Bit] has been confirmed as ON, please turn it OFF again. It is recommended to turn OFF the bit 0 of [Print Word Address] also at this timing.

Continued

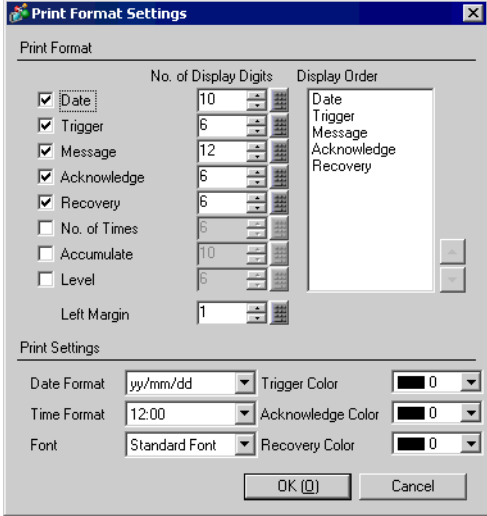
Setting	Description
<p>Print Format</p>	<p>Displays the [Print Format Settings] dialog box.</p> 
<p>Print Settings</p> <p>Select blocks to print</p>	<p>Specify the blocks to print from [Date], [Trigger], [Message], [Acknowledge], [Recovery], [No. of Times], [Accumulate], and [Level].</p> <ul style="list-style-type: none"> • Date Prints the date when the alarm was triggered. • Trigger Prints the time when the alarm was triggered. • Message Prints Alarm Message. • Acknowledge Prints the time when the alarm message was confirmed. • Recovery Prints alarm's recovery time. • No. of Times Prints the number of times the alarm was triggered. The maximum count is 65,535. • Accumulate Prints the total duration of time when the alarm was in the triggered state. The maximum duration is 9,999 hours 59 minutes 59 seconds. • Level Prints alarm's importance level.

Continued

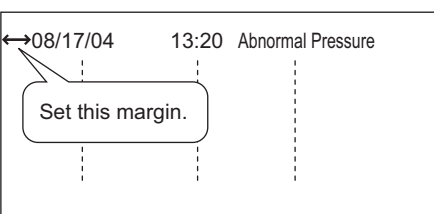
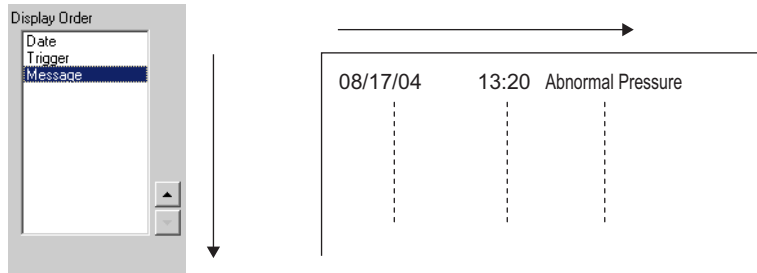
Setting	Description								
Print Settings Print Format No. of Display Char.	Set the number of characters displayed for each item. Each item's setting range is as follows. <table border="1" data-bbox="452 260 1241 569"> <tr> <td data-bbox="452 260 661 353">Date</td> <td data-bbox="661 260 1241 353">5 to 100 or 8 to 100 characters (The setting range differs depending on the selected date format)</td> </tr> <tr> <td data-bbox="452 353 661 446">Trigger, Acknowledge, Recovery</td> <td data-bbox="661 353 1241 446">5 to 100 or 8 to 100 characters (The setting range differs depending on the selected time format)</td> </tr> <tr> <td data-bbox="452 446 661 479">Message</td> <td data-bbox="661 446 1241 479">1 to 160 characters</td> </tr> <tr> <td data-bbox="452 479 661 569">No. of Times, Accumulate, Level</td> <td data-bbox="661 479 1241 569">2 to 100 characters</td> </tr> </table> <p data-bbox="408 589 493 627">NOTE</p> <ul data-bbox="408 637 1241 743" style="list-style-type: none"> • When you want to provide spaces between the items, set [No. of Display Digits] larger than the number of characters that will actually be displayed. 	Date	5 to 100 or 8 to 100 characters (The setting range differs depending on the selected date format)	Trigger, Acknowledge, Recovery	5 to 100 or 8 to 100 characters (The setting range differs depending on the selected time format)	Message	1 to 160 characters	No. of Times, Accumulate, Level	2 to 100 characters
	Date	5 to 100 or 8 to 100 characters (The setting range differs depending on the selected date format)							
	Trigger, Acknowledge, Recovery	5 to 100 or 8 to 100 characters (The setting range differs depending on the selected time format)							
	Message	1 to 160 characters							
	No. of Times, Accumulate, Level	2 to 100 characters							
Left Margin	Select the spacing between the character of the left-most item and the border from 0 to 100 characters. 								
Display Order	Set the display order of all items. Blocks starting from the top of this list will be printed from left to right. 								
Date Format	Choose a print format for the date from [yy/mm/dd], [mm/dd/yy], [dd/mm/yy], and [mm/dd].								
Time Format	Choose a print format for the time from [12:00],[24:00],[12:00:00],[24:00:00]								
Font	Choose a font type for the Alarm Message from [Standard Font] or [Stroke Font].								

Continued

Setting		Description
Print Settings	Print Format	<p>Choose from 8 colors for the Alarm Message's [Trigger], [Acknowledge], and [Recovery] colors. Messages are printed in the specified colors regardless of the GP type.</p> <p>NOTE</p> <ul style="list-style-type: none"> • When white is selected, messages are printed in black. • When the [Display Mode] is [History] and [Batch Print] is set, the trigger color will be used when printing a triggered alarm, the acknowledge color for an acknowledged alarm, and the recovery color for a recovered alarm. However, when acknowledging a previously recovered alarm, the recovery color will be used for printing. The color setting is effective for text only. The background color will not be printed.
Backing up History		<p>Select whether or not to backup the Alarm History to the backup SRAM of the GP.</p> <p>☞ “◆ About Backup SRAM” (page 19-73)</p> <p>When backup is not selected and the GP is turned OFF, all the Alarm Histories displayed before are erased. When the GP is turned ON again, only the alarms triggered at the time and afterward are displayed.</p> <p>■ Do not backup history</p>

Continued

Setting	Description
<p style="writing-mode: vertical-rl; transform: rotate(180deg);">Backing up History</p> <p>Alarm Continuous Action at Power ON</p>	<p>Select the display method to use when power is turned ON.</p> <ul style="list-style-type: none"> • Display as a new Alarm The information of the host (PLC) before the GP was turned OFF is not retained. The Alarm Messages that were displayed before the GP was turned OFF are displayed as recovered state after the power is turned ON again. Any continuing alarms are separately displayed as new alarms. • Hide Continuing Alarms The information of the host (PLC) before the GP was turned OFF is retained. The Alarm Messages that were displayed before the GP was turned OFF are continuously displayed when power is turned ON again. If the trigger/recovery state of alarms changes after the GP was turned ON again, the change is displayed. <p>Backup Function Examples</p> <p>■ Display as a New Alarm</p> <p>■ Hide Continuing Alarms</p>

Continued

Setting	Description
External Operation	Select whether or not to perform [Ack All], [Clear All], [Clear All No. of Occurrences], and [Clear All Accumulated Time] from the host (PLC). ☞ "19.10.3 Restrictions for Performing External Operation from Multiple GPs" (page 19-144)
Control Word Address	Set the address which will control the type of operation performed from the PLC (operation code), and the type of alarm. <div style="text-align: center; margin: 10px 0;"> <pre> 15-----0 ----- Operation code ----- ----- Alarm type ----- ----- +0-----+1 </pre> </div> <div style="display: flex; justify-content: space-around; margin: 10px 0;"> <div style="border: 1px solid black; padding: 5px; width: 40%;"> 0: No operation 1: Ack All 2: Clear All 3: Clear All No.s of Occurrences 4: Clear All Accumulated Time </div> <div style="border: 1px solid black; padding: 5px; width: 40%;"> 0: Block 1 data 1: Block 2 data : : 7: Block 8 data </div> </div> <div style="margin-top: 10px;"> <p>NOTE</p> <ul style="list-style-type: none"> When an external operation is performed, it handles all Alarm Messages in the block (active, history, log). For example, if you perform a [Clear All] on block 1, all Alarm Messages in block 1 (active, history, log) are cleared. The Alarm Messages assigned to active, history, and log within the block are not treated individually. The operation's order is [History]→[Log]→ [Active]. </div>
Completion Bit Address	Set the address which will monitor the completion of the operation. This bit will turn ON when the operation finishes.

Continued

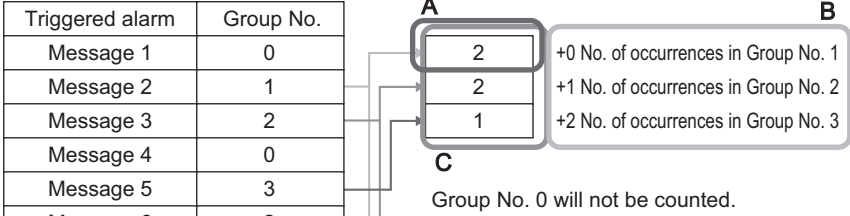
Setting	Description																
Using Group Feature	Select whether or not to use the Group feature. Set this feature to count the number of times that alarms have been triggered by group number.																
<p>No. of Alarms Write Start Address (Internal Device Word Address)</p>	<p>(A) Set the start address in the GP internal device to write the number of alarm occurrences.</p> <p>(B) Among the addresses set up in (A), only those with the registered group number are used as the area for the writing frequency of internal device addresses.</p> <p>(C) Each time an alarm occurs, data in the corresponding group number's address (internal device) will be increased by 1.</p> <table border="1" data-bbox="412 633 754 904"> <thead> <tr> <th>Triggered alarm</th> <th>Group No.</th> </tr> </thead> <tbody> <tr><td>Message 1</td><td>0</td></tr> <tr><td>Message 2</td><td>1</td></tr> <tr><td>Message 3</td><td>2</td></tr> <tr><td>Message 4</td><td>0</td></tr> <tr><td>Message 5</td><td>3</td></tr> <tr><td>Message 6</td><td>2</td></tr> <tr><td>Message 7</td><td>1</td></tr> </tbody> </table>  <p>NOTE</p> <ul style="list-style-type: none"> • The largest group number available is 6096. As a result, you can set a different group number to every alarm message. • Please ensure that the number of groups is within the internal device's area (USR area or LS area). For the LS area, refer to the following. <ul style="list-style-type: none"> ☞ "A.1.4 LS Area (Direct Access Method)" (page A-8) • The alarm frequency gets erased when the GP unit is turned OFF. When backing up the data, please use the internal device's backup feature. <ul style="list-style-type: none"> ☞ "5.13.6 [System Settings Window] Settings Guide ■ [Main Unit Settings] Settings Guide ◆ Operation Settings" (page 5-103) • The frequency can be counted from 0 to 65,535. Even when the frequency passes 65,535, the count will still remain there. • When data is written to an internal device which stores alarm frequency or the GP's power turns OFF, data will be cleared and will not be counted properly. • The data format of the alarm frequency is fixed as Bin. • Alarms with group number 0 are not counted. 	Triggered alarm	Group No.	Message 1	0	Message 2	1	Message 3	2	Message 4	0	Message 5	3	Message 6	2	Message 7	1
Triggered alarm	Group No.																
Message 1	0																
Message 2	1																
Message 3	2																
Message 4	0																
Message 5	3																
Message 6	2																
Message 7	1																
Enable Banner	Configure Alarm Messages to display as scroll banners. ☞ "■ Alarm Settings Guide (Banner)" (page 19-82)																
Enable Summary	This setting displays currently active alarms in a list. ☞ "■ Alarm Settings Guide (Summary)" (page 19-85)																

◆ About Backup SRAM

The backup SRAM saves data even when the GP unit's power is OFF.

The backup SRAM's user area is used to save not only the Alarm History data but also the sampling data, internal device backup data, and filing data.

The capacity of the backup SRAM that can be used for Alarm History data depends on the type of GP and the space used by other data.

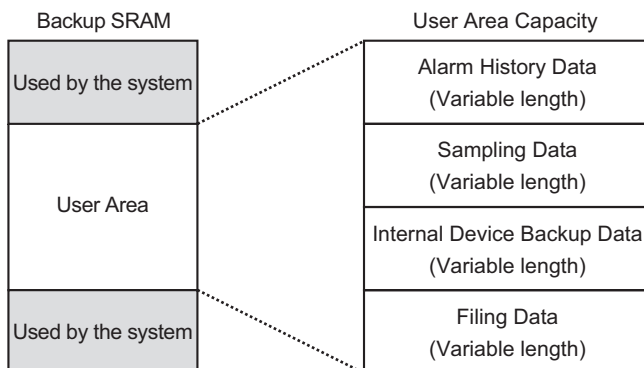

Backup SRAM has the following usage priorities:

- (1) Alarm History data
- (2) Sampling data
- (3) Internal device backup data
- (4) Filing data

IMPORTANT

- The Alarm History data stored in the backup SRAM is erased when:
 - Screen transfer occurs
 - Memory is reset (Offline)
 - Backup SRAM is initialized (Offline)

Space Requirements for Alarm History Data

The space of the backup SRAM required to save the Alarm History data depends on the number of [Records] of all blocks and the number of registered messages (addresses). When no message is registered, the data size is 0 byte regardless of the [Backup History] setting.

Calculation

- Size of the Alarm History data (all blocks) (Unit: byte)

$$= 576 + (28 \times \text{No. of records}) + (16 \times \text{No. of registered messages}) + 2 \times (4 \times \text{No. of registered messages})$$

Calculation Example

Setting	Description
No. of records (total of all blocks)	768
No. of registered messages	2048

Calculation result $(576) + (28 \times 768) + (16 \times 2,048) + 2 \times (4 \times 2,048) = 71,232$ bytes

■ Alarm Settings Guide (Block 1)

There are two types of Trigger Method for the Alarm History: [Bit Monitoring] and [Word Monitoring].

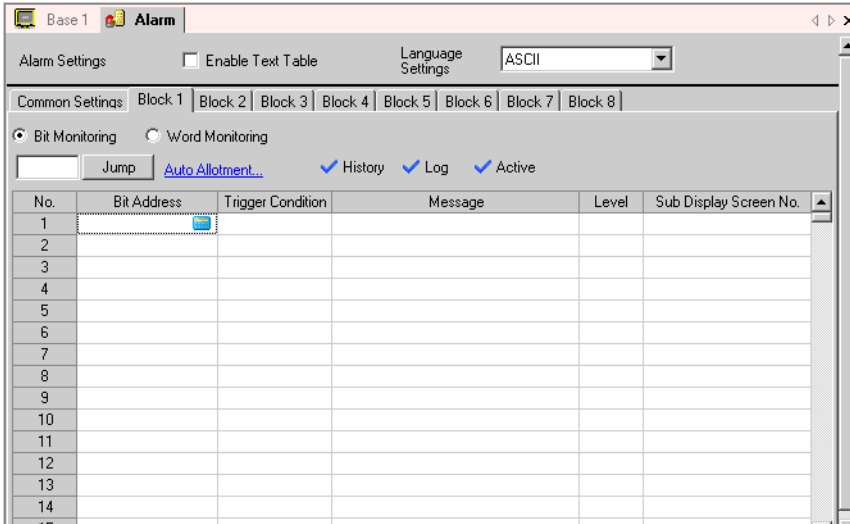

◆ Bit Monitoring

Configure settings to trigger the Alarm by monitoring a bit's ON/OFF state.

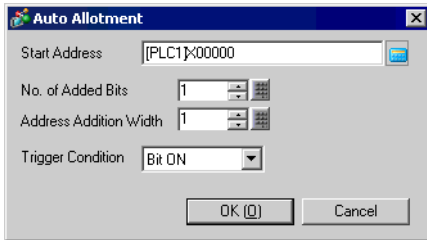

Setting	Description
Bit Monitoring	The alarm is triggered when the monitoring bit address turns ON (OFF).
Jump	Jump to a specific row number.
Auto Allotment	<p>The [Auto Allotment] dialog box will appear. Configure settings to allocate designated addresses from [Start Address] by specified increments.</p>  <p>NOTE</p> <ul style="list-style-type: none"> When any previous address setting exists, it will be overwritten.
Start Address	Set the Bit Address that will start the Auto Allotment.
No. of Added Bits	Set the number of Bit Addresses (from 1 to “Alarm Settings’ limit - Current row position + 1”) for Auto Allotment.
Address Addition Width	Set the number of bits to add during an Auto Allotment, from 0 to 4,096.
Trigger Condition	Sets up if the alarm is triggered when the monitoring bit address turns ON or when the monitoring bit address turns OFF.

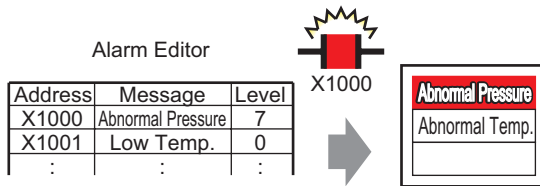
Continued

Setting	Description												
History/Log/Active	Displays current display mode set in the [Common Settings] tab.  “ ■ Alarm Settings Guide (Common Settings)” (page 19-64)												
No.	Displays the Alarm Message’s registration number (Row No.) from 2048 to 8,999. <div style="border: 1px solid black; padding: 2px; width: fit-content; margin-bottom: 10px;">NOTE</div> <ul style="list-style-type: none"> For Alarm Messages, up to 2,048 Monitor Bits and Monitor Words can be registered but the maximum number of Alarms that can be stored by the GP for the whole Alarm History is 768. 												
Bit Address	Set the Bit Address to monitor the alarm’s trigger. <div style="border: 1px solid black; padding: 2px; width: fit-content; margin-bottom: 10px;">IMPORTANT</div> <ul style="list-style-type: none"> Please ensure that the total of [Monitoring Bit Address] and [Monitoring Word Address] for the whole Alarm History (Block 1 to Block 8) are within 256 words. 												
Trigger Condition	Sets up if the alarm is triggered when the monitoring bit address turns ON or when the monitoring bit address turns OFF.												
Message	Set an alarm message within 160 single-byte characters. <div style="border: 1px solid black; padding: 2px; width: fit-content; margin-bottom: 10px;">NOTE</div> <ul style="list-style-type: none"> When [Enable Text Table] is selected, this displays with the text table’s number of index characters. 												
Level	Each Alarm Message is ranked by importance from 0 (least important) to 7 (most important). The initial setting is “0”. The Trigger, Acknowledgement, and Recovery colors for each level can be set with the Alarm Part. <div style="text-align: center; margin: 10px 0;">  <p>Alarm Editor</p> <table border="1" style="border-collapse: collapse; text-align: center;"> <thead> <tr> <th>Address</th> <th>Message</th> <th>Level</th> </tr> </thead> <tbody> <tr> <td>X1000</td> <td>Abnormal Pressure</td> <td>7</td> </tr> <tr> <td>X1001</td> <td>Low Temp.</td> <td>0</td> </tr> <tr> <td>:</td> <td>:</td> <td>:</td> </tr> </tbody> </table> <p>X1000</p> </div> <p style="text-align: center;">Choose the color and attributes for 8 levels according to each Alarm's content.</p> <p> “19.9.2 Alarm Part Settings Guide ■ Show History ◆ Color Settings” (page 19-94)</p>	Address	Message	Level	X1000	Abnormal Pressure	7	X1001	Low Temp.	0	:	:	:
Address	Message	Level											
X1000	Abnormal Pressure	7											
X1001	Low Temp.	0											
:	:	:											
Group No.	This item is displayed only when [Enable the Group feature] is selected in the [Common Settings] tab. Set a group number to each alarm message within the range between 0 and 6,096.  “ ■ Alarm Settings Guide (Common Settings)” (page 19-64) <div style="border: 1px solid black; padding: 2px; width: fit-content; margin-bottom: 10px;">NOTE</div> <ul style="list-style-type: none"> When the [Group No.] is “0”, it will not count. 												

Continued

Setting	Description
Sub Display Screen No.	<p>When using an Alarm part for a Sub Display, select the desired Base Screen No. from 0 to 9,999, or the Text No. from 0 to 8,999. To play back movies, select the index No. of the play list file.</p> <p>NOTE</p> <ul style="list-style-type: none">• If no Sub Display is required, enter “0”. The initial setting is “0”.

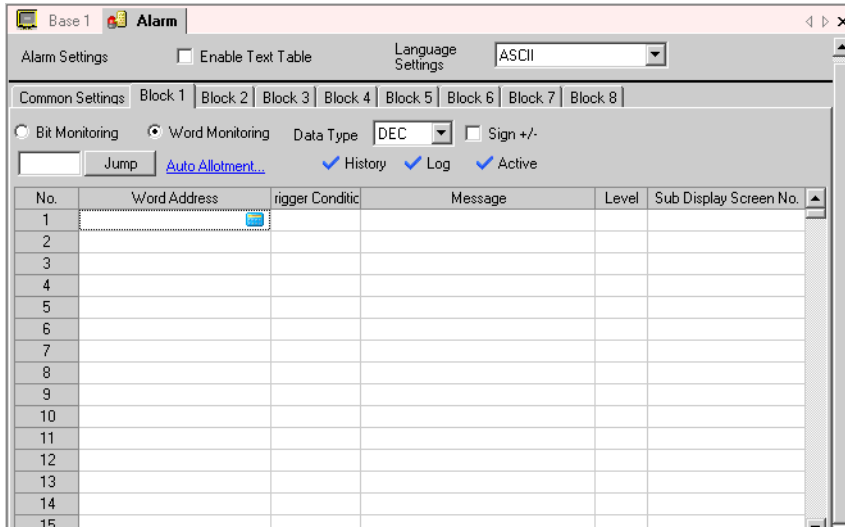

◆ **Word Monitoring**

Configure settings to trigger the Alarm by monitoring a word data's value.



Setting	Description
Word Monitoring	An alarm is triggered when the value of the monitoring word address matches with the specified alarm value, or is within the specified alarm range.
Data Type	Choose the data format of the value stored in [Word Address] from [Dec], [Hex], or [BCD]. <div style="border: 1px solid black; padding: 2px; width: fit-content; margin: 5px 0;">NOTE</div> <ul style="list-style-type: none"> When the [Data Type] is changed during editing, the data (alarm value) which cannot be converted into the new [Data Type] will become “0”. e.g.)Dec 10→Hex 000A Dec 10→BCD 0 (Cannot be converted and displayed as 0.)
Sign +/-	Select this if you will be using negative data for the alarm value. This can only be set when the [Data Type] is [Dec].
Jump	Jump to a specific row number.

Continued

Setting	Description
<p>Auto Allotment</p>	<p>The [Auto Allotment] dialog box will appear. Configure settings to allocate designated addresses from [Start Address] by specified increments.</p> <div data-bbox="614 305 1042 544" style="text-align: center;"> </div> <p>NOTE</p> <ul style="list-style-type: none"> • When any previous address setting exists, it will be overwritten.
<p>Start Address</p>	<p>Set the Word Address that will start the Auto Allotment.</p>
<p>No. of Added Words</p>	<p>Set the number of Word Addresses (from 1 to “Alarm Settings’ limit - Current row position + 1”) for Auto Allotment.</p>
<p>Address Addition Width</p>	<p>Set the number of Words to add during an Auto Allotment, from 0 to 4,096.</p>
<p>Trigger Condition</p>	<p>Set the condition that will trigger the alarm. Click  and the [Trigger Condition Settings] dialog box will be displayed.</p>
<p>History/Log/Active</p>	<p>Displays current display mode set in the [Common Settings] tab.  “ ■ Alarm Settings Guide (Common Settings)” (page 19-64)</p>
<p>No.</p>	<p>Displays the Alarm Message’s registration number (Row No.) from 768 to 8,999.</p> <p>NOTE</p> <ul style="list-style-type: none"> • For Alarm Messages, up to 2,048 Monitor Bits and Monitor Words can be registered but the maximum number of Alarms that can be stored by the GP for the whole Alarm History is 768.
<p>Word Address</p>	<p>Set the Word Address to monitor the alarm’s trigger.</p> <p>IMPORTANT</p> <ul style="list-style-type: none"> • Please ensure that the total of [Monitoring Bit Address] and [Monitoring Word Address] for the whole Alarm History (Block 1 to Block 8) are within 256 words.

Continued

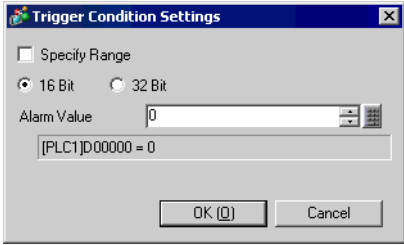
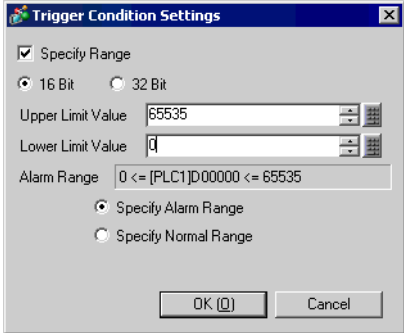
Setting	Description																														
Trigger Condition	<p>Set the alarm value that will trigger the alarm. Click the cell  and the [Trigger Condition Settings] dialog box will be displayed.</p> 																														
16 Bit/32 Bit	Choose the alarm value's bit length from [16 Bit] or [32 Bit].																														
Alarm Value	<p>Select which range of values stored in the monitoring word address will trigger the alarm. The set range varies depending on the [Data Type] and [Sign +/-].</p> <table border="1" data-bbox="423 716 1203 1029"> <thead> <tr> <th>Bit Length</th> <th>Data Type</th> <th>Sign +/-</th> <th>Setting Range</th> </tr> </thead> <tbody> <tr> <td rowspan="3">16 Bit</td> <td rowspan="2">Dec</td> <td>Checked</td> <td>-32768 to 32767</td> </tr> <tr> <td>Unchecked</td> <td>0 to 65535</td> </tr> <tr> <td>Hex</td> <td>—</td> <td>0 to FFFF</td> </tr> <tr> <td></td> <td>BCD</td> <td>—</td> <td>0 to 9999</td> </tr> <tr> <td rowspan="3">32 bit</td> <td rowspan="2">Dec</td> <td>Checked</td> <td>-2147483648 to 2147483647</td> </tr> <tr> <td>Unchecked</td> <td>0 to 4294967295</td> </tr> <tr> <td>Hex</td> <td>—</td> <td>0 to FFFFFFFF</td> </tr> <tr> <td></td> <td>BCD</td> <td>—</td> <td>0 to 99999999</td> </tr> </tbody> </table>	Bit Length	Data Type	Sign +/-	Setting Range	16 Bit	Dec	Checked	-32768 to 32767	Unchecked	0 to 65535	Hex	—	0 to FFFF		BCD	—	0 to 9999	32 bit	Dec	Checked	-2147483648 to 2147483647	Unchecked	0 to 4294967295	Hex	—	0 to FFFFFFFF		BCD	—	0 to 99999999
Bit Length	Data Type	Sign +/-	Setting Range																												
16 Bit	Dec	Checked	-32768 to 32767																												
		Unchecked	0 to 65535																												
	Hex	—	0 to FFFF																												
	BCD	—	0 to 9999																												
32 bit	Dec	Checked	-2147483648 to 2147483647																												
		Unchecked	0 to 4294967295																												
	Hex	—	0 to FFFFFFFF																												
	BCD	—	0 to 99999999																												
Specify Range	<p>Select whether or not to set a range for the alarm value. The display will change as follows.</p> 																														

Continued

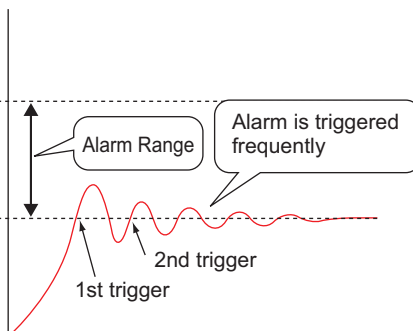
Setting		Description																												
Trigger Condition	Upper Limit/ Lower Limit	<p>Select which range of values stored in the monitoring word address will trigger the alarm. The set range varies depending on the [Data Type] and [Sign +/-].</p> <table border="1"> <thead> <tr> <th>Bit Length</th> <th>Data Type</th> <th>Sign +/-</th> <th>Setting Range</th> </tr> </thead> <tbody> <tr> <td rowspan="4">16 Bit</td> <td rowspan="2">Dec</td> <td>Checked</td> <td>-32768 to 32767</td> </tr> <tr> <td>Unchecked</td> <td>0 to 65535</td> </tr> <tr> <td>Hex</td> <td>—</td> <td>0 to FFFF</td> </tr> <tr> <td>BCD</td> <td>—</td> <td>0 to 9999</td> </tr> <tr> <td rowspan="4">32 bit</td> <td rowspan="2">Dec</td> <td>Checked</td> <td>-2147483648 to 2147483647</td> </tr> <tr> <td>Unchecked</td> <td>0 to 4294967295</td> </tr> <tr> <td>Hex</td> <td>—</td> <td>0 to FFFFFFFF</td> </tr> <tr> <td>BCD</td> <td>—</td> <td>0 to 99999999</td> </tr> </tbody> </table>	Bit Length	Data Type	Sign +/-	Setting Range	16 Bit	Dec	Checked	-32768 to 32767	Unchecked	0 to 65535	Hex	—	0 to FFFF	BCD	—	0 to 9999	32 bit	Dec	Checked	-2147483648 to 2147483647	Unchecked	0 to 4294967295	Hex	—	0 to FFFFFFFF	BCD	—	0 to 99999999
	Bit Length	Data Type	Sign +/-	Setting Range																										
	16 Bit	Dec	Checked	-32768 to 32767																										
Unchecked			0 to 65535																											
Hex		—	0 to FFFF																											
BCD		—	0 to 9999																											
32 bit	Dec	Checked	-2147483648 to 2147483647																											
		Unchecked	0 to 4294967295																											
	Hex	—	0 to FFFFFFFF																											
	BCD	—	0 to 99999999																											
Alarm Range	The specified alarm range is displayed.																													
Specify Range	<ul style="list-style-type: none"> Specify Alarm Range Set the alarm range as “Lower Limit Value ≤ Address Value ≤ Upper Limit Value”. Specify Normal Range Set the alarm range as “Lower Limit Value ≥ Address Value” or “Address value ≥ Upper Limit Value”. <p>NOTE</p> <ul style="list-style-type: none"> If the alarm value stored in the [Word Address] fluctuates frequently, the alarm will be triggered often. E.g.) When $50 \leq \text{Alarm Range} \leq 100$ 																													
Specify Alarm Range																														
Specify Normal Range																														

Continued

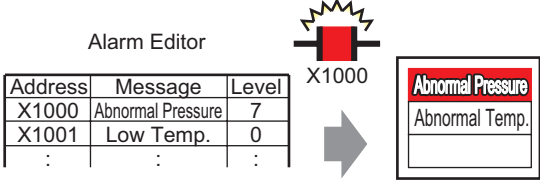
Setting	Description												
<p>Message</p>	<p>Set an alarm message within 160 single-byte characters.</p> <p>NOTE</p> <ul style="list-style-type: none"> When [Enable Text Table] is selected, this displays with the text table's number of index characters. 												
<p>Level</p>	<p>Each Alarm Message is ranked by importance from 0 (least important) to 7 (most important). The initial setting is "0". The Trigger, Acknowledgement, and Recovery colors for each level can be set with the Alarm Part.</p> <div style="text-align: center;">  <p>Alarm Editor</p> <table border="1" data-bbox="565 589 853 681"> <thead> <tr> <th>Address</th> <th>Message</th> <th>Level</th> </tr> </thead> <tbody> <tr> <td>X1000</td> <td>Abnormal Pressure</td> <td>7</td> </tr> <tr> <td>X1001</td> <td>Low Temp.</td> <td>0</td> </tr> <tr> <td>:</td> <td>:</td> <td>:</td> </tr> </tbody> </table> <p>X1000</p> <p>Abnormal Pressure</p> <p>Abnormal Temp.</p> </div> <p>Choose the color and attributes for 8 levels according to each Alarm's content.</p> <p>☞ "19.9.2 Alarm Part Settings Guide ■ Show History ◆ Color Settings" (page 19-94)</p>	Address	Message	Level	X1000	Abnormal Pressure	7	X1001	Low Temp.	0	:	:	:
Address	Message	Level											
X1000	Abnormal Pressure	7											
X1001	Low Temp.	0											
:	:	:											
<p>Group No.</p>	<p>This item is displayed only when [Enable the Group feature] is selected in the [Common Settings] tab. Set a group number to each alarm message within the range between 0 and 6,096.</p> <p>☞ "■ Alarm Settings Guide (Common Settings)" (page 19-64)</p> <p>NOTE</p> <ul style="list-style-type: none"> When the [Group No.] is "0", it will not count. 												
<p>Sub Display Screen No.</p>	<p>When using an Alarm part for a Sub Display, select the desired Base Screen No. from 0 to 9999, or the Text No. from 0 to 8999. To play back movies, select the index No. of the play list file.</p> <p>NOTE</p> <ul style="list-style-type: none"> If no Sub Display is required, enter "0". The initial setting is "0". 												

■ Alarm Settings Guide (Banner)

Configure Alarm Messages to display as scroll banners.

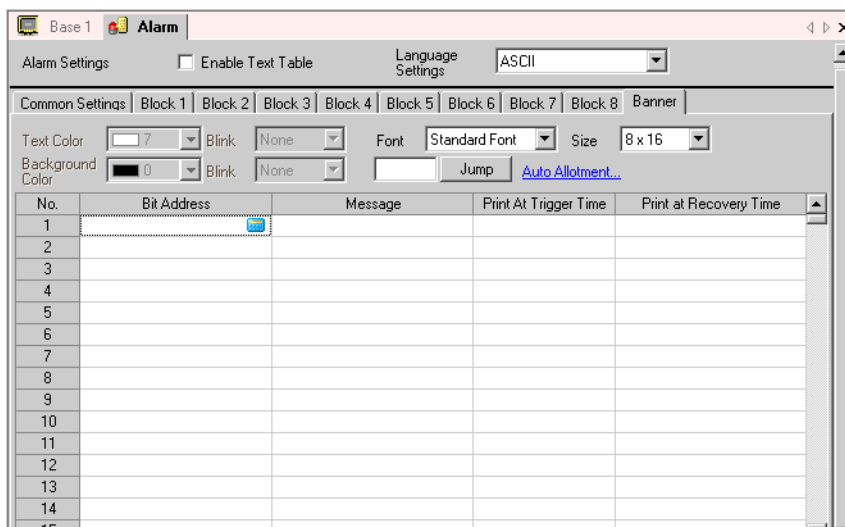

Setting	Description
Text Color	Select a color for the message's text.
Background Color	Select a background color for the message's text.
Blink	Select whether or not the Switch will blink, and the blink speed. You can choose different blink settings for [Text Color] and [Background Color]. <div style="border: 1px solid black; padding: 2px; width: fit-content;">NOTE</div> <ul style="list-style-type: none"> There are cases where you can and cannot set Blink depending on the Main Unit and System Settings' [Color Settings]. ☞ "9.5.1 Setting Colors ■ List of Available Colors" (page 9-34)
Font	Choose a font type for the Alarm Message from [Standard Font] or [Stroke Font].
Character Size	Choose a text size for the Alarm Message. Each font type has a different range of styles. Standard Font: [8 × 16], [8 × 32], [8 × 64], [16 × 16], [16 × 32], [16 × 64], [32 × 16], [32 × 32], [32 × 64] Stroke Font: [8], [16], [32]
Jump	Jump to a specific row number.

Continued

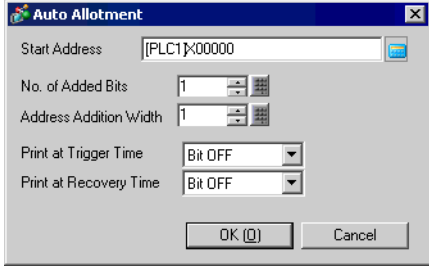
Setting	Description									
Auto Allotment	<p>The [Auto Allotment] dialog box will appear. Configure settings to allocate designated addresses from the starting address.</p>  <p>NOTE</p> <ul style="list-style-type: none"> • When any previous address setting exists, it will be overwritten. 									
<table border="1" style="width: 100%; border-collapse: collapse;"> <tr> <td data-bbox="152 672 392 720">Start Address</td> <td data-bbox="392 672 1275 720">Set the Bit Address that will start the Auto Allotment.</td> </tr> <tr> <td data-bbox="152 720 392 807">No. of Added Bits</td> <td data-bbox="392 720 1275 807">Set the number of Bit Addresses (from 1 to “Alarm Settings’ limit - Current row position + 1”) for Auto Allotment.</td> </tr> <tr> <td data-bbox="152 807 392 884">Address Addition Width</td> <td data-bbox="392 807 1275 884">Set the number of bits to add during an Auto Allotment, from 0 to 4,096.</td> </tr> <tr> <td data-bbox="152 884 392 967">Print at Trigger Time</td> <td data-bbox="392 884 1275 967" rowspan="2">Select whether or not to print the trigger time (or recovery time) along with the Alarm Message at the triggering of (recovery from) the alarm. Set this to [ON] to print.</td> </tr> <tr> <td data-bbox="152 967 392 1045">Print at Recovery Time</td> </tr> </table>	Start Address	Set the Bit Address that will start the Auto Allotment.	No. of Added Bits	Set the number of Bit Addresses (from 1 to “Alarm Settings’ limit - Current row position + 1”) for Auto Allotment.	Address Addition Width	Set the number of bits to add during an Auto Allotment, from 0 to 4,096.	Print at Trigger Time	Select whether or not to print the trigger time (or recovery time) along with the Alarm Message at the triggering of (recovery from) the alarm. Set this to [ON] to print.	Print at Recovery Time	
Start Address	Set the Bit Address that will start the Auto Allotment.									
No. of Added Bits	Set the number of Bit Addresses (from 1 to “Alarm Settings’ limit - Current row position + 1”) for Auto Allotment.									
Address Addition Width	Set the number of bits to add during an Auto Allotment, from 0 to 4,096.									
Print at Trigger Time	Select whether or not to print the trigger time (or recovery time) along with the Alarm Message at the triggering of (recovery from) the alarm. Set this to [ON] to print.									
Print at Recovery Time										
No.	Displays the Banner Alarm Message’s registration number (row number) from 1 to 512.									
Bit Address	<p>Set the Bit Address to monitor the alarm’s trigger. When the Monitoring Bit Address turns ON (Trigger), the Alarm Message scrolls. When the monitor bit address turns OFF (Recovery), the Alarm Message display ends.</p> <p>NOTE</p> <ul style="list-style-type: none"> • Set the monitoring bits within 128 words for the whole Alarm Message (Banner). 									
Message	<p>Set an alarm message within 160 single-byte characters.</p> <p>NOTE</p> <ul style="list-style-type: none"> • When [Enable Text Table] is selected, this displays with the text table’s number of index characters. 									

Continued

Setting	Description																																								
<p>Print at Trigger Time Print at Recovery Time</p>	<p>Select whether or not to print the trigger time (or recovery time) along with the Alarm Message at the triggering of (recovery from) the alarm. Set this to [ON] to print.</p> <p>NOTE</p> <ul style="list-style-type: none"> The print color is limited to black. Printing will use the font designated in the [Banner] tab of [Alarm Settings]. When Alarm Message Language is set to Japanese, status like “Trigger” or “Recovery” will be output in Japanese. When that is set to other language but Japanese (Western, Korean, Chinese (Traditional), Chinese (Simplified), Cyrillic or Thai), they will be automatically output in English. <div style="display: flex; justify-content: space-around; align-items: flex-start;"> <div style="text-align: center;"> <p>When [Japanese] is set</p> <table border="1" style="border-collapse: collapse; font-size: small;"> <tr><td>発報</td><td>10/15</td><td>16:07</td><td>No.1 エラー</td></tr> <tr><td>復旧</td><td>10/15</td><td>16:30</td><td>No.1 エラー</td></tr> <tr><td>発報</td><td>10/21</td><td>11:25</td><td>No.1 エラー</td></tr> <tr><td>発報</td><td>10/21</td><td>11:28</td><td>No.3 エラー</td></tr> <tr><td>復旧</td><td>10/21</td><td>15:45</td><td>No.1 エラー</td></tr> </table> <p>Japanese</p> </div> <div style="text-align: center;"> <p>When [Chinese (Simplified)] is set</p> <table border="1" style="border-collapse: collapse; font-size: small;"> <tr><td>WARNING</td><td>10/15</td><td>16:07</td><td>No.1 错误</td></tr> <tr><td>RESTORED</td><td>10/15</td><td>16:30</td><td>No.1 错误</td></tr> <tr><td>WARNING</td><td>10/21</td><td>11:25</td><td>No.1 错误</td></tr> <tr><td>WARNING</td><td>10/21</td><td>11:28</td><td>No.3 错误</td></tr> <tr><td>RESTORED</td><td>10/21</td><td>15:45</td><td>No.1 错误</td></tr> </table> <p>English</p> </div> <div style="text-align: center;"> <p>Selected language</p> </div> </div> <ul style="list-style-type: none"> The GP unit can store printing information for a maximum of 1,000 Alarm Messages (Banner) and Alarm Histories (Real Time Print). If no printer is connected to the GP, it can still store up to 1,000 messages, but any messages over 1,000 will be lost while the GP is waiting to print. If the printer goes offline during printing due to a paper jam, etc., fix the printer error without turning off the GP’s power. Print information stored in the GP will be sent to the printer when it comes back online. If the printer’s power goes off during printing, the data sent from the GP during that time will not be printed. 	発報	10/15	16:07	No.1 エラー	復旧	10/15	16:30	No.1 エラー	発報	10/21	11:25	No.1 エラー	発報	10/21	11:28	No.3 エラー	復旧	10/21	15:45	No.1 エラー	WARNING	10/15	16:07	No.1 错误	RESTORED	10/15	16:30	No.1 错误	WARNING	10/21	11:25	No.1 错误	WARNING	10/21	11:28	No.3 错误	RESTORED	10/21	15:45	No.1 错误
発報	10/15	16:07	No.1 エラー																																						
復旧	10/15	16:30	No.1 エラー																																						
発報	10/21	11:25	No.1 エラー																																						
発報	10/21	11:28	No.3 エラー																																						
復旧	10/21	15:45	No.1 エラー																																						
WARNING	10/15	16:07	No.1 错误																																						
RESTORED	10/15	16:30	No.1 错误																																						
WARNING	10/21	11:25	No.1 错误																																						
WARNING	10/21	11:28	No.3 错误																																						
RESTORED	10/21	15:45	No.1 错误																																						

■ Alarm Settings Guide (Summary)

This setting displays triggered alarms in a list.

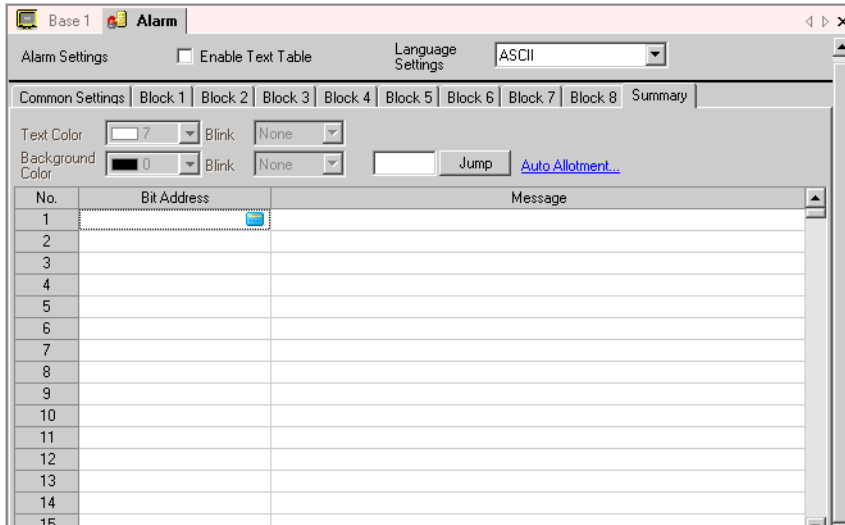

Setting	Description
Text Color	Select a color for the message's text.
Background Color	Select a background color for the message's text.
Blink	Select whether or not the Switch will blink, and the blink speed. You can choose different blink settings for [Text Color] and [Background Color]. <div style="border: 1px solid black; padding: 2px; width: fit-content;">NOTE</div> <ul style="list-style-type: none"> There are cases where you can and cannot set Blink depending on the Main Unit and System Settings' [Color Settings]. ☞ "9.5.1 Setting Colors ■ List of Available Colors" (page 9-34)
Jump	Jump to a specific row number.
Auto Allotment	The [Auto Allotment] dialog box will appear. Configure settings to allocate designated addresses from [Start Address] by specified increments. <div style="text-align: center;"> </div> <div style="border: 1px solid black; padding: 2px; width: fit-content; margin-top: 10px;">NOTE</div> <ul style="list-style-type: none"> When any previous address setting exists, it will be overwritten.

Continued

Setting		Description
	Start Address	Set the Bit Address that will start the Auto Allotment.
	No. of Added Bits	Set the number of Bit Addresses (from 1 to “Alarm Settings’ limit - Current row position + 1”) for Auto Allotment.
	Address Addition Width	Set the number of bits to add during an Auto Allotment, from 0 to 4,096.
No.		Displays the Alarm Message’s registration number (Row No.) from 1 to 8,999.
Bit Address		<p>Set the Bit Address to monitor the alarm’s trigger. When the Monitoring Bit Address turns ON, the alarm triggers and the Alarm Message is displayed. When the Monitoring Bit Address turns OFF, the alarm recovers and the Alarm Message is erased.</p> <p>NOTE</p> <ul style="list-style-type: none"> For the Monitoring Bit Address, please use a word-designated bit device, or a bit-designated word device. Please allocate the Monitoring Bit Addresses of the Alarm Messages displayed in a single Alarm Part (Summary) as continuous addresses inside the same device. It cannot be set over different types of devices.
Message		<p>Set an alarm message within 160 single-byte characters.</p> <p>NOTE</p> <ul style="list-style-type: none"> When [Enable Text Table] is selected, this displays with the text table’s number of index characters.

19.9.2 Alarm Part Settings Guide

Configure settings for the Part to display the Alarm Messages registered in [Alarm Settings]. There are two types of display methods: [Show History] and [Summary].

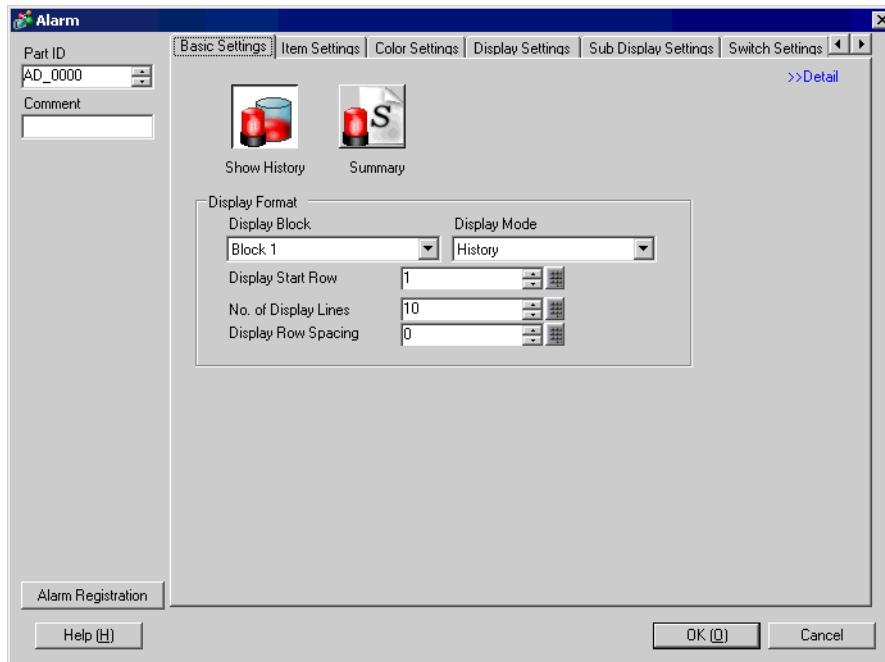

Setting	Description
Part ID	Placed parts are automatically assigned an ID number. Alarm Part ID: AD_**** (4 digits) The letter portion is fixed. The number portion can be modified from 0000 to 9999.
Comment	The comment for each Part can be up to 20 characters long.
Alarm Registration	Change to the Common Settings' [Alarm Settings].
Display Type	Select the Alarm part's type. <ul style="list-style-type: none"> • Show History Alarm Messages are displayed in a row in order of when they were triggered. ☞ " ■ Show History" (page 19-88) • Summary Alarm Messages that are currently active are displayed in a list. ☞ " ■ Show History" (page 19-88)

■ **Show History**

Alarm Messages are displayed in a row in order of when they were triggered.

◆ **Basic Settings/Basic**

Set the display format of the Alarm Messages.

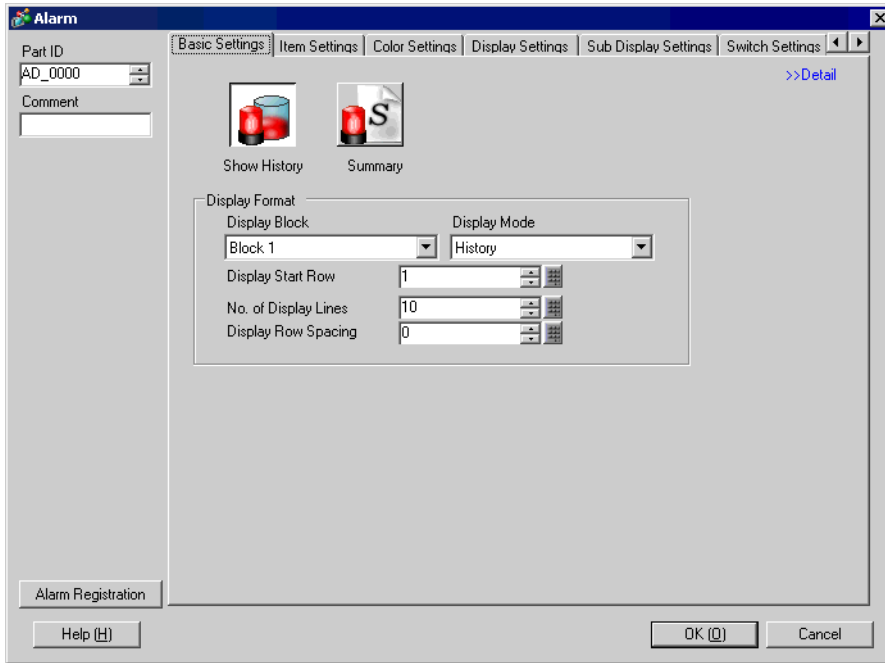

Setting	Description
Display Format	Set the format of the Alarm History display.
Display Block	Choose the block with which the desired Alarm Messages are registered from [Block 1] to [Block 8].
Display Mode	Choose the Alarm Message's display method from [History], [Log], or [Active]. ☞ "19.9.1 Alarm Settings Guide ■ Alarm Settings Guide (Common Settings)" (page 19-64)
Display Start Row	Set the row where the Alarm Message will start displaying from 1 to 768.
No. of Display Lines	Set how many Alarm Message rows will display on one screen from 1 to 50.
Display Row Spacing	Set the space between Alarm Messages from 0 to 7 dots. A  A From 0 to 7 dots.

◆ **Basic Settings/Detail**

You can change the Alarm Messages' Display Direction and Sort Order.

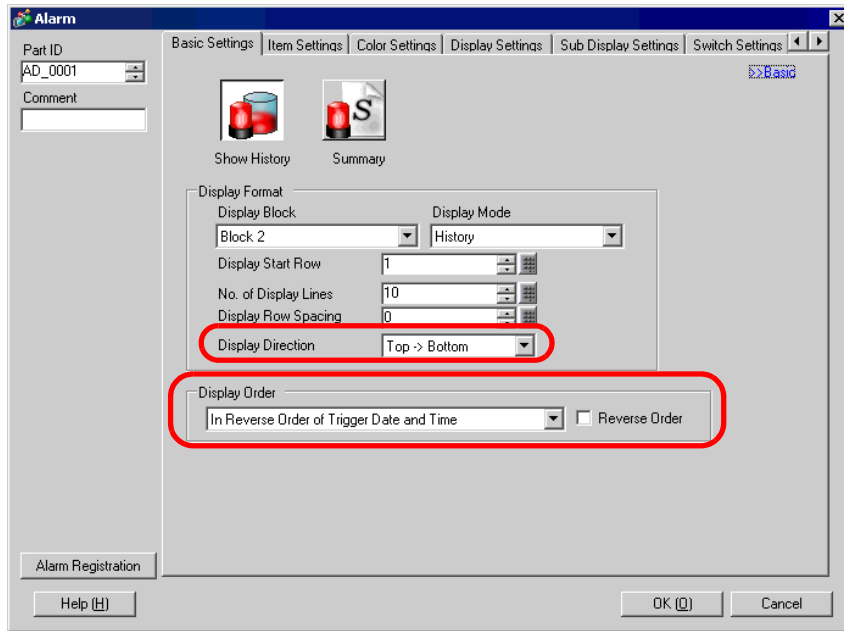

Setting	Description
<p>Display Direction</p>	<p>Choose the scroll direction for the Alarm Message from [Bottom →Top] or [Top→ Bottom].</p> <p>Registered message</p> <div style="border: 1px solid black; padding: 5px; width: fit-content;"> <p>No. 1 Pump Closed Tank A Low Water Tank B Abnormal Pressure : :</p> </div> <p>Trigger order : Tank B Abnormal Pressure→Pump 1 Closed →Tank A Low Water Sort order : In Reverse Order of Trigger Date and Time</p> <ul style="list-style-type: none"> • When scroll direction is [Bottom→Top] <div style="display: flex; align-items: center; margin-top: 10px;"> <div style="margin-right: 10px;"> Scroll direction ↑ Start position → </div> <div style="border: 1px solid black; padding: 5px; flex-grow: 1;"> <p>04/07/25 09:19 Tank B Abnormal Pressure 04/07/25 14:20 No. 1 Pump Closed 04/07/25 20:23 Tank A Low Water</p> </div> </div> • When scroll direction is [Top→Bottom] <div style="display: flex; align-items: center; margin-top: 10px;"> <div style="margin-right: 10px;"> Start position → Scroll direction ↓ </div> <div style="border: 1px solid black; padding: 5px; flex-grow: 1;"> <p>04/07/25 20:23 Tank A Low Water 04/07/25 14:20 No. 1 Pump Closed 04/07/25 09:19 Tank B Abnormal Pressure</p> </div> </div>

Continued

Setting	Description
Display Order	Select the display order for Alarm Messages from [In Reverse Order of Trigger Date], [In No. of Occurrences Order], [In Descending Order of Accumulated Time], [Level & In Reverse Order of Trigger Date], [Level & In Descending Order of No. of Occurrences], or [Alarm Registration Order].
Reverse Order	Display items in reverse [Display Order].

◆ **Item Settings/Basic**

Configure the items, the number of characters, and the date/time format displayed in the Alarm Part. The item names are not displayed on the GP screen. To display the item names, set them by selecting [Detail].

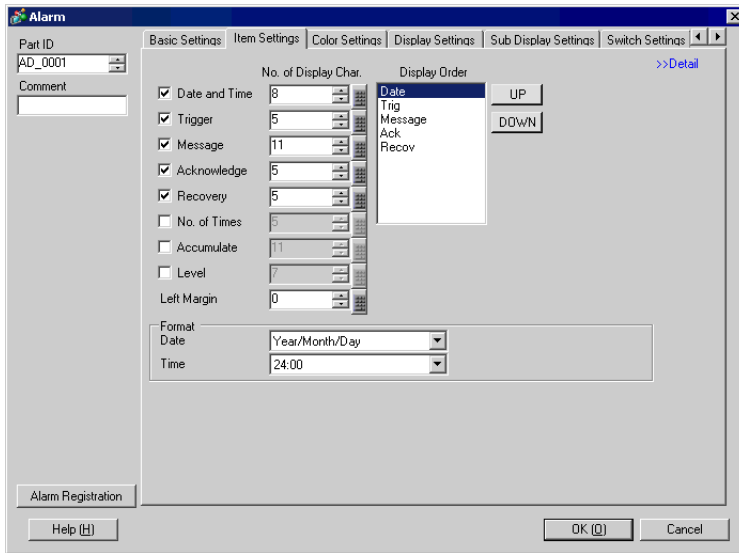

Setting	Description
Select Items to Display	<p>Choose which items to display in the Alarm part from [Date and Time], [Trigger], [Message], [Acknowledge], [Recovery], [No. of Times], [Accumulate], and [Level].</p> <ul style="list-style-type: none"> • Date Displays the date and time when the alarm was triggered. • Trigger Displays the time when alarm was triggered. • Message Displays Alarm Message. • Acknowledge Displays the time when alarm message was confirmed. • Recovery Displays alarm's recovery time. • No. of Times Displays the number of times alarm was triggered. The maximum count is 65,535. • Accumulate Displays the total duration of time when the alarm was in the triggered state. The maximum duration is 9,999 hours 59 minutes 59 seconds. • Level Displays the Alarm Message's set importance level. <p>NOTE</p> <ul style="list-style-type: none"> • Once the values of [No. of Times] and [Accumulate] reach the maximum, they will remain there.

Continued

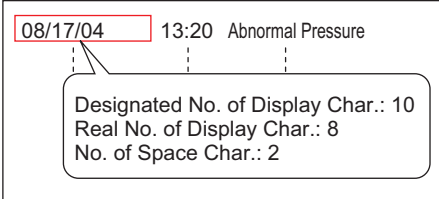
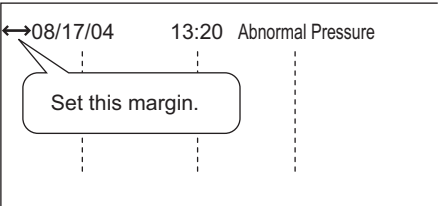
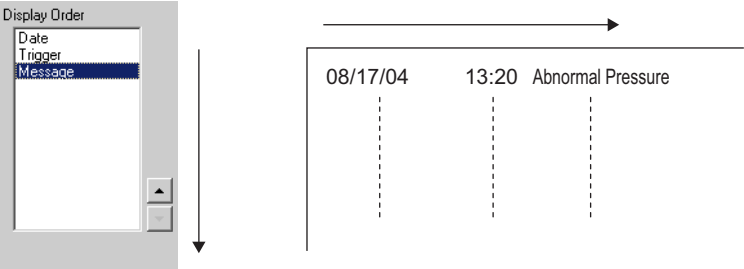
Setting	Description
<p>No. of Display Char.</p>	<p>Set the number of characters displayed for each item. Set a value so that the total of [No. of Display Char.] and [Left Margin] for the item is within 160 single-byte characters.</p> <p>NOTE</p> <ul style="list-style-type: none"> When you want to provide spaces between the items, set a value larger than the number of characters that will actually be displayed. 
<p>Left Margin</p>	<p>Select the spacing between the left-most item name and the border. Set a value so that the total of [No. of Display Char.] and [Left Margin] is within 160 single-byte characters.</p> 
<p>Display Order</p>	<p>Set the display order of all items. Items starting from the top of this list will be displayed on the Alarm part from left to right.</p> 
<p>Format</p>	<p>Set the date and time format.</p>
<p>Date</p>	<p>Choose a format for the date from [Month/Day/Year], [Month/Day], [Year/Month/Day], or [Day/Month/Year].</p>
<p>Time</p>	<p>Choose a format for the time from [12:00], [24:00], [12:00:00], [24:00:00]</p>

◆ **Item Settings/Detail**

Set the Item Names to display in the Alarm part.

No Item Names

08/17/04	15:10	Tank A ...
08/17/04	16:23	Tank B ...

Has Item Names

Date	Trigger	Message
08/11/04	15:10	Tank A ...
08/11/04	16:23	Tank B ...

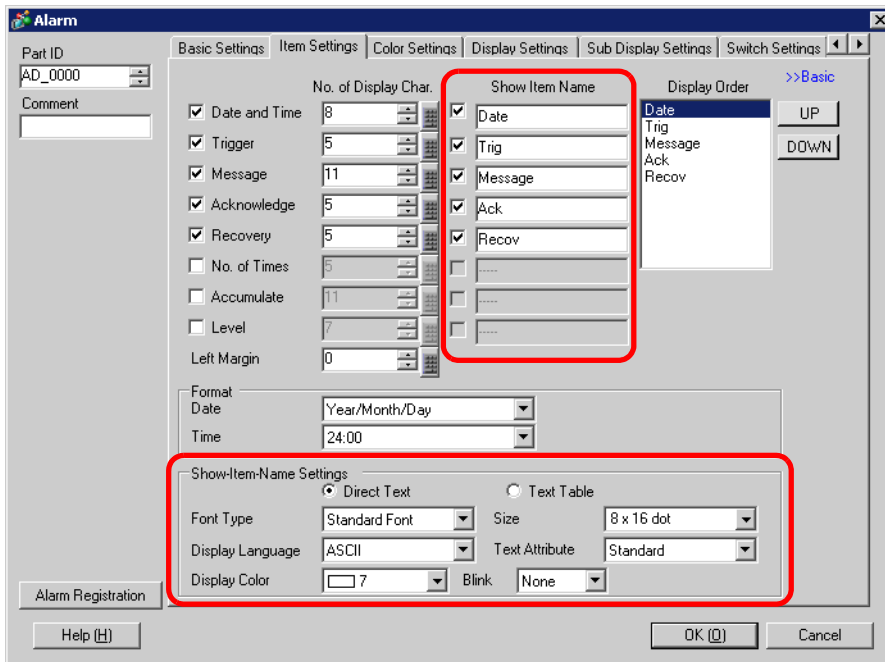

Setting	Description
Show Item Name	Check the item names to be displayed, and enter the item name's text.
Show Item Name Settings	Configure settings for Item Name display.
Direct Text/Text Table	<p>Set whether to input directly for item names or to reference text registered in a Text Table.</p> <ul style="list-style-type: none"> • Direct Text Directly input the item name to be displayed. • Text Table Use an Item Name registered in a Text Table. ☞ "15.7.6 Alarm Part - Item Settings/Detail (Text Table) Settings Guide" (page 15-57)
Font Type	Choose a font type for the item names from [Standard Font] or [Stroke Font].

Continued

Setting	Description
Show Item Name Settings	Character Size Choose a font size for the Item Names. Standard Font: Specify “Width × Height” within the range between [8 × 8] to [64 × 128] in the unit of 8 dots, or select a fixed size from [6 × 10], [8 × 13], and [13 × 23]. The fixed sizes can be selected for displaying single-byte alphanumeric characters only. Stroke Font: 6 to 127
	Display Language If you select [Direct Text], select the language for item names: [Japanese], [Western], [Chinese (Traditional)], [Chinese (Simplified)], [Korean], [Cyrillic], or [Thai].
	Text Attribute Select the font’s text attributes. Standard Font: Choose from [Standard], [Bold], or [Shadow] (When a fixed size [6 × 10] is selected, choose from [Standard] or [Shadow].) Stroke Font: Choose from [Standard], [Bold], [Outline]
	Display Color Choose a color for the Item Names.
	Blink Select whether or not the part will blink, and the blink speed. <div style="border: 1px solid black; padding: 2px; width: fit-content;">NOTE</div> <ul style="list-style-type: none"> • There are cases where you can and cannot set Blink depending on the Main Unit and System Settings’ [Color Settings]. ☞ “9.5.1 Setting Colors ■ List of Available Colors” (page 9-34)

◆ **Color Settings**

Alarm Messages can be color-coded according to whether they are in the [Trigger], [Acknowledge], or [Recovery] state.

When Alarm Messages have levels attached during the registration, the levels can also be color-coded.

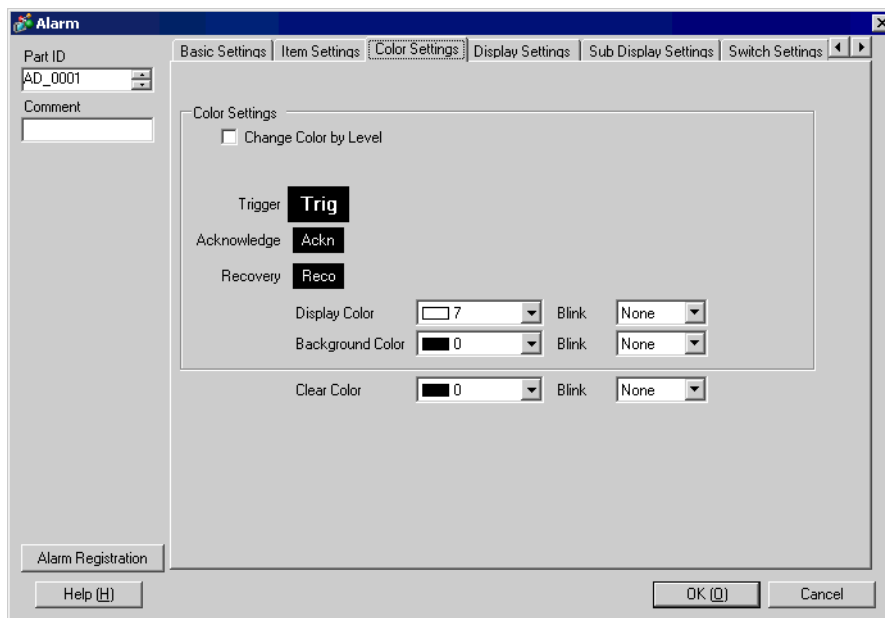

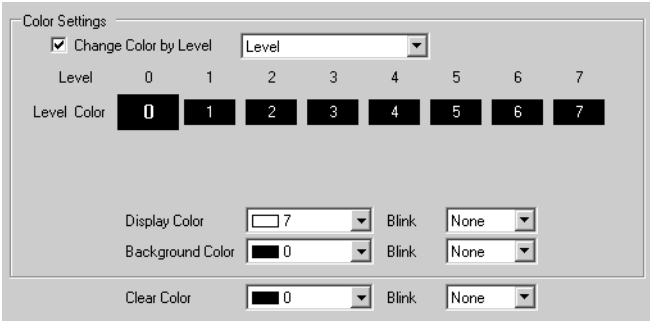
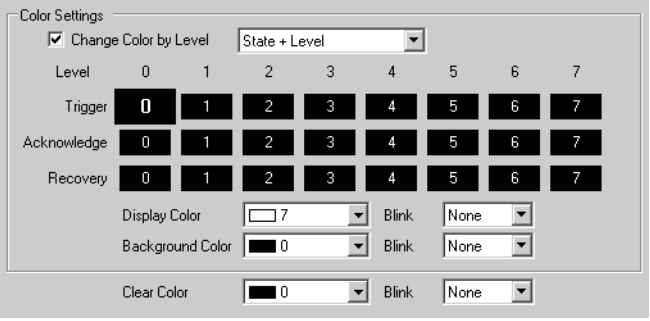
Setting	Description
Color Settings	Configure color settings to correspond to the states of Alarm Messages (Trigger, Acknowledge, and Recovery).
Change Color By Level	<p>Select this to color code the various Alarm Messages by their attached level set in [Alarm Settings]. Choose the color-coding criteria from [Level] or [State+Level].</p> <ul style="list-style-type: none"> Level Display the color based on the level (8 levels from 0 to 7) set in the [Block] in [Alarm Settings].  <ul style="list-style-type: none"> State+Level Display the color based on the level (8 levels from 0 to 7) set in the [Block] in [Alarm Settings], and divide each level into colors based on the state [Trigger], [Acknowledge], and [Recovery]. 
Trigger/ Acknowledge/ Recovery	<p>Specify the state to set a color.</p> <p>NOTE</p> <ul style="list-style-type: none"> When a recovered alarm message is acknowledged, the message is displayed in the color specified to the recovery state.
Display Color	Select a color for the Alarm Message's text.
Background Color	Select a background color for the Alarm Message.
Clear Color	Select a color used when an Alarm Message is cleared or not displayed.

Continued

Setting	Description
Blink	<p>Select whether or not the Switch will blink, and the blink speed. You can choose different blink settings for [Text Color], [Background Color], and [Clear Color].</p> <p>NOTE</p> <ul style="list-style-type: none"> • There are cases where you can and cannot set Blink depending on the Main Unit and System Settings' [Color Settings]. <p> "9.5.1 Setting Colors ■ List of Available Colors" (page 9-34)</p>

◆ **Display Settings**

Set a font and border for the Alarm Message.

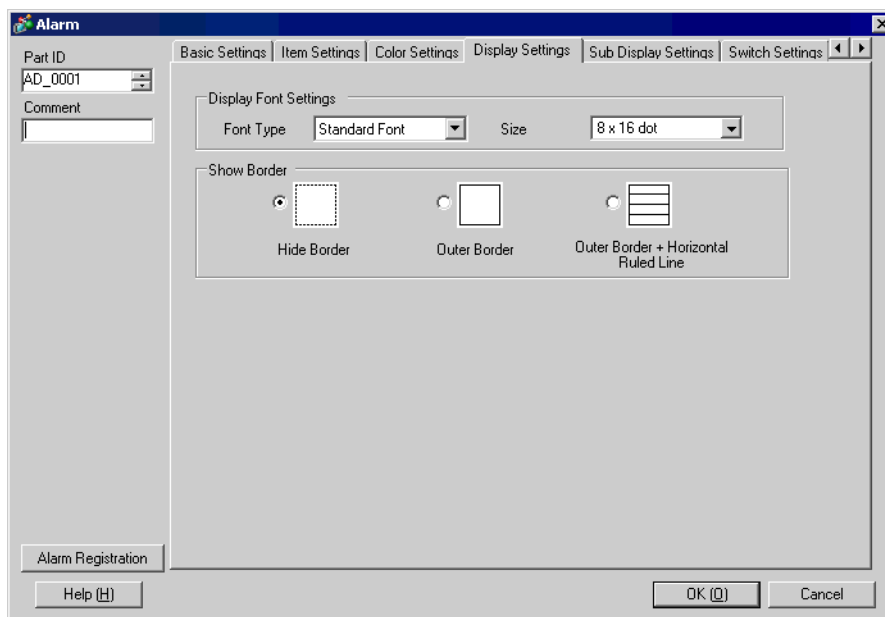

Setting	Description
Display Font Settings	Set a font for the text.
Font Type	Choose a font type for the Alarm Message from [Standard Font] or [Stroke Font].
Character Size	<p>Choose a font size for the Item Names.</p> <p>Standard Font: Specify “Width × Height” within the range between [8 × 8] to [64 × 128] in the unit of 8 dots, or select a fixed size from [6 × 10], [8 × 13], [13 × 23]. The fixed sizes can be selected for displaying single-byte alphanumeric characters only.</p> <p>Stroke Font: 6 to 127</p>

Continued

Setting	Description
Show Border	<p>Choose the Alarm Message's border from [Hide Border], [Outer Border], or [Outer Border + Horizontal Ruled Line].</p> <p>NOTE</p> <ul style="list-style-type: none">• The color of the border and ruled line is fixed to white.• When [Outer Border + Horizontal Ruled Line] is selected, set the [Display Row Spacing] to "1" or a larger value. When "0" is set, the horizontal ruled lines cannot be displayed.

◆ **Sub Display Settings/Basic**

You can set a different Sub Screen to display when each Alarm Message is touched.

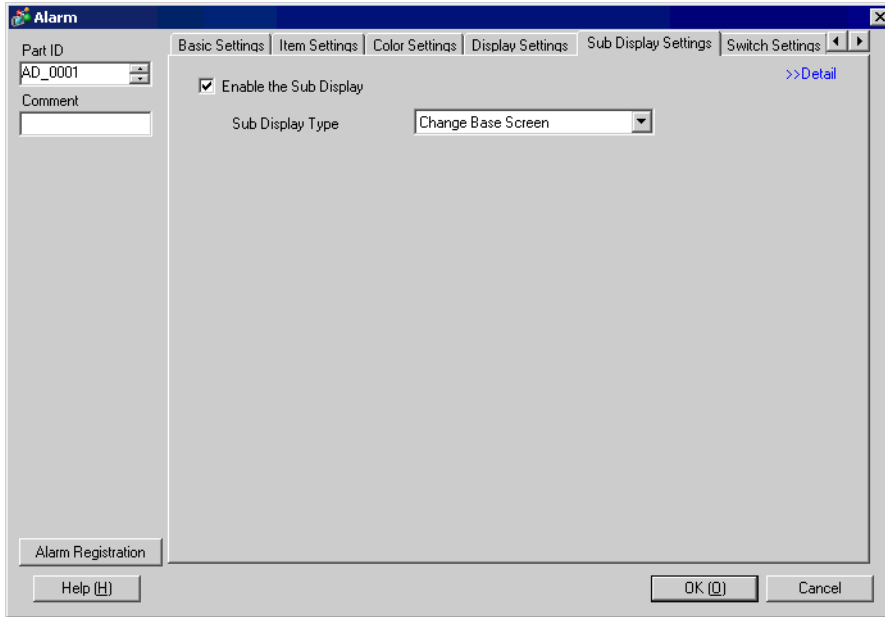

Setting	Description
Enable the Sub Display	Select whether or not to use a Sub Display.
Sub Display Type	<p>Select the Sub Display's Type.</p> <ul style="list-style-type: none"> • Change Base Screen This setting changes the entire screen to another screen. It works the same as a normal screen change. In [Alarm Settings], set the [Sub Display Screen No.] to the destination [Base Screen No.]. • Show Text Window Display [Text] in a Window. In [Alarm Settings], set the [Sub Display Screen No.] to the [Text No.] you want to display in the window. <div data-bbox="463 1282 1177 1460" style="border: 1px solid gray; padding: 5px; margin: 10px 0;"> <p>Sub Display Type: Show Text Window</p> <p>Window Size: <input type="radio"/> Large <input checked="" type="radio"/> Minor</p> <p><small>Caution: To register a text, the no. of characters in a row must be within 40.</small></p> </div>
Window Size	<p>When the [Sub Display Type] is [Show Text Window], choose the window's size from [Large] or [Minor].</p> <p>NOTE</p> <ul style="list-style-type: none"> • The maximum number of text characters on one line of a window is as follows. Large Window Size: Up to 30 characters Minor Window Size: Up to 20 characters

◆ **Sub Display Settings/Detail**

You can set up a sub-display that changes the Base screen or Window screen, or a sub-display that shows a picture display, message display, or movie player on a Base or Window screen.

☞ “19.10.2 Restrictions for Sub Display Settings/Detail” (page 19-143)

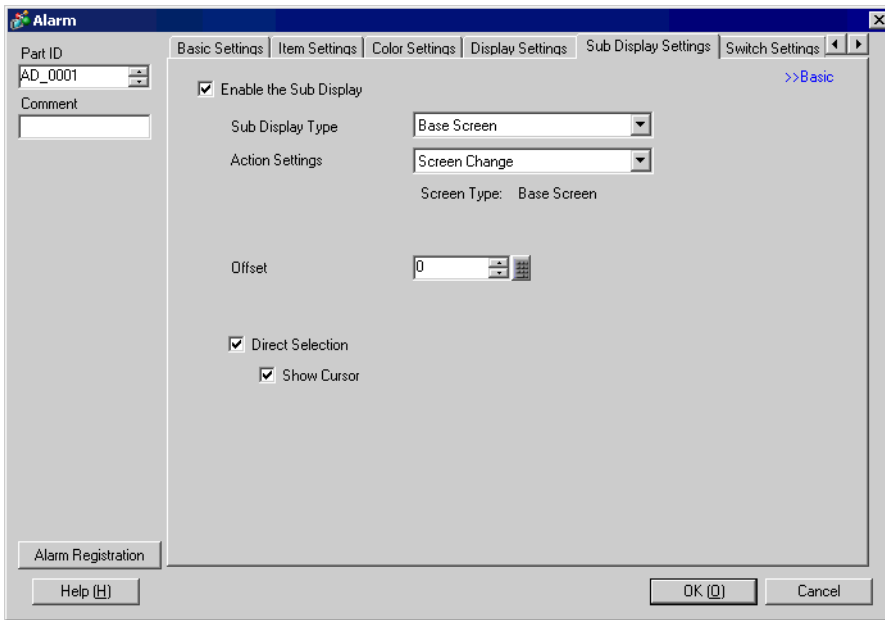

Setting	Description
Enable the Sub Display	Select whether or not to use a Sub Display.
Sub Display Type	Select the Sub Display's Type. <ul style="list-style-type: none"> • Base Screen Change the display to other screen, or display a picture or text directly on a base screen. • Window Display a Sub Screen in a Window. Change the window to another one, or display a picture or text in the Window. <div style="border: 1px solid black; padding: 2px; margin: 5px 0;">NOTE</div> <ul style="list-style-type: none"> • An alarm message with a [Sub Display Screen No.] equal to “0” will not display a Sub Screen.

Continued

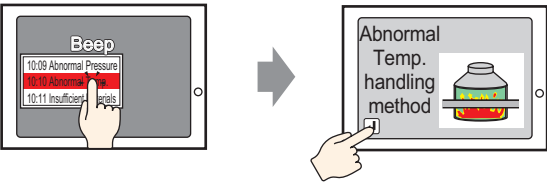
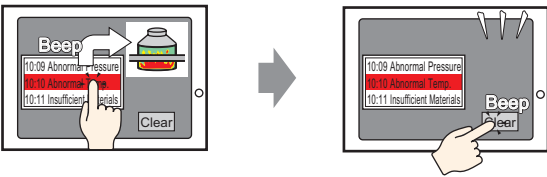
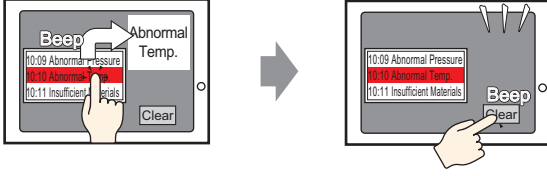
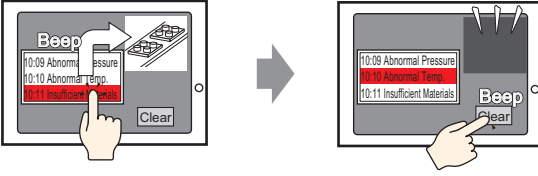
Setting	Description
<p>Action Settings (Base Screen)</p>	<p>When the [Sub Display Type] is [Base Screen], select one of the following actions: [Screen Change], [Change Picture Display], [Text Display Change], or [Play Movie].</p> <ul style="list-style-type: none"> <p>Screen Change Change the screen to display the sub screen.</p>  <p>Touch the alarm message, and the screen changes to the screen corresponding to the message is displayed.</p> <p>Touch the Change Screen Switch to return to the alarm screen.</p> <p>Change Picture Display Use a Picture Display to display the sub screen.</p>  <p>Touch the alarm message, and a picture corresponding to the message is displayed.</p> <p>Touch the Clearing Switch created separately to erase the sub display.</p> <p>Text Display Change Use a Message Display to display the sub screen.</p>  <p>Touch the alarm message, and a text corresponding to the message is displayed.</p> <p>Touch the Clearing Switch created separately to erase the sub display.</p> <p>Play Movie Use a Movie Player to display the sub-screen..</p>  <p>Touch the alarm message, and the movie corresponding to the message is played.</p> <p>Touch the clearing switch created separately, (turning the Play Bit OFF), to close the sub-screen.</p>

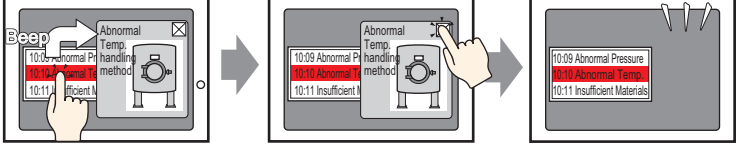
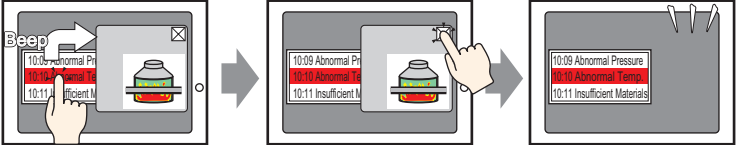
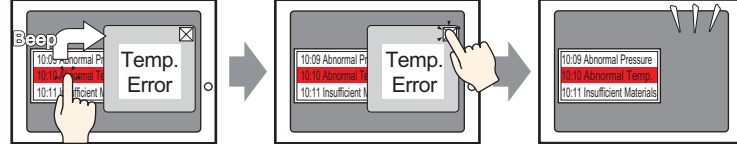
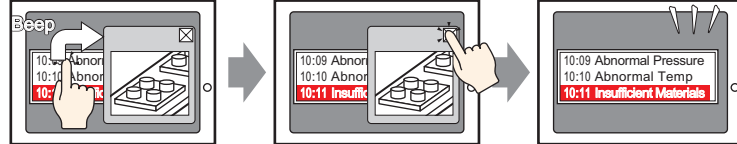
Setting	Description
<p>Action Settings (Window)</p>	<p>When the [Sub Display Type] is [Window], select one of the following actions: [Window Change], [Change Picture Display], [Text Display Change], or [Play Movie].</p>
	<ul style="list-style-type: none"> • Window Change Change the Window Screen to display the sub screen.
	 <p>Touch the alarm message, and a Window Screen corresponding to the message is displayed.</p> <p>Touch the switch specially created to delete the window.</p> <p>Window display is erased</p>
	<ul style="list-style-type: none"> • Change Picture Display Use a Picture Display to display the sub screen.
	 <p>Touch the alarm message, and a picture corresponding to the message is displayed in a window.</p> <p>Touch the switch specially created to delete the window.</p> <p>Window display is erased</p>
<ul style="list-style-type: none"> • Text Display Change Use a Message Display to display the sub screen. 	
 <p>Touch the alarm message, and a text corresponding to the message is displayed in a window.</p> <p>Touch the switch specially created to delete the window.</p> <p>Window display is erased</p>	
<ul style="list-style-type: none"> • Play Movie Use a Movie Player to display the sub screen. 	
 <p>Touch the alarm message. The window changes to display the corresponding movie file.</p> <p>Touch the Clearing Switch created separately.</p> <p>Window display is erased.</p>	

Continued

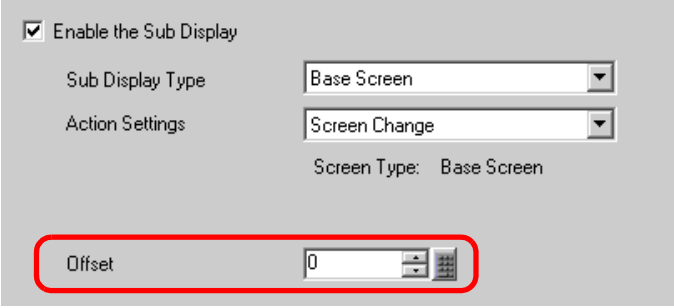
Setting	Description
Direct Selection	<p>The Alarm Message displayed on the screen can be selected by touching it directly. When the Alarm Message to which a Sub screen has been set is touched, the Sub screen is displayed.</p>  <p>When this option is not designated, use the [Switch Settings] tab and place a [Sub Display] switch to display a sub screen.</p>
Show Cursor	<p>If [Direct Selection] is designated, set whether or not to display the cursor when the Alarm Message is touched.</p>
[Base Screen] - [Screen Change]	<p>This setting changes the entire screen to another screen. This operation works the same as a normal screen change.</p> 
Offset	<p>Set the offset value for the Sub Display Screen No. from 0 to 9999. The screen designated as “[Sub Display Screen No.] in [Alarm Settings] + Offset value” will be displayed.</p>

Continued

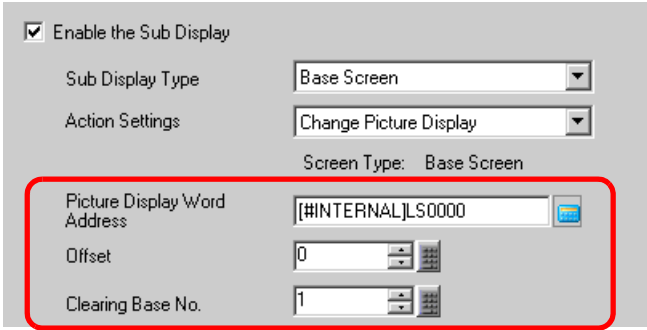
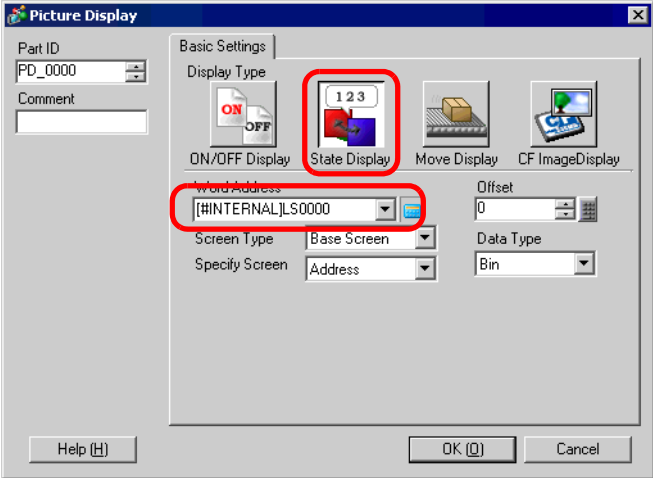
Setting	Description
<p>[Base Screen] - [Screen Change]</p>	<p>Display a picture corresponding to the Alarm Message in the Picture Display placed on the same screen as the Alarm Part.</p> 
<p>Picture Display Word Address</p>	<p>Specify the address of the GP internal device (LS area, user area) to store the number which has been set in [Sub Display Screen No.] in [Alarm Settings]. The number stored in this address is the base screen No. displayed on the Picture Display.</p> <p>Set the same address to the [Word Address] of the Picture Display placed on the same screen as the Alarm Part.</p>  <p>NOTE</p> <ul style="list-style-type: none"> • Set the Picture Display's [Screen Type] to [Base Screen], [Specify Screen] to [Address], and [Data Type] to [Bin].
<p>Offset</p>	<p>Set the offset value for the Sub Display Screen No. from 0 to 9999. The screen designated as "[Sub Display Screen No.] in [Alarm Settings] + Offset value" will be displayed.</p>
<p>Clearing Base No.</p>	<p>When you select the [Sub Display Screen No.] in [Alarm Settings] to be Alarm Message "0", the base screen designated here will be called and the previous screen will be erased. Set the screen number that has been created to clear the contents (such as a screen with a black-filled square) from 1 to 9,999.</p>

Continued

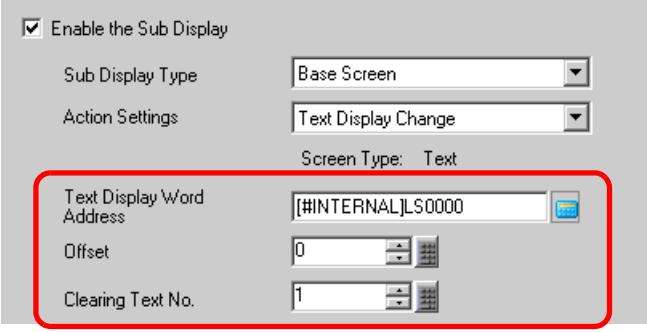
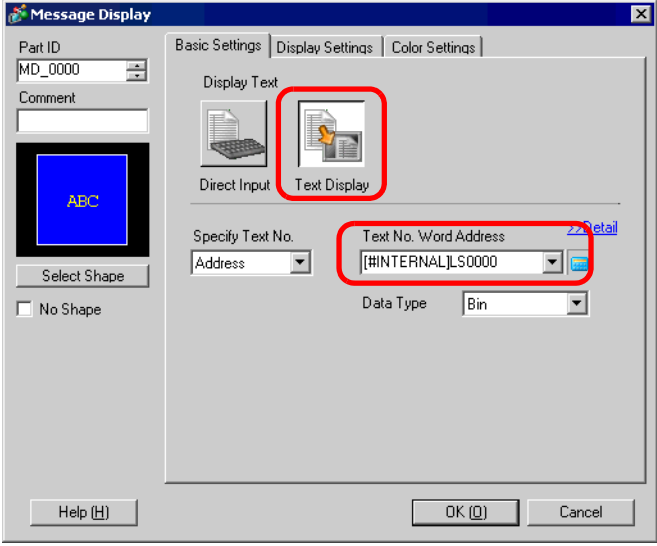
Setting	Description
[Base Screen] - [Text Display Change]	<p>Display a text corresponding to the Alarm Message in the Message Display placed on the same screen as the Alarm Part.</p> 
Text Display Word Address	<p>Specify the address of the GP internal device (LS area, user area) to store the number which has been set in [Sub Display Screen No.] in [Alarm Settings]. The number stored in this address is the text No. displayed on the Message Display.</p> <p>Set the same address to the [Text No. Word Address] of the Message Display placed on the same screen as the Alarm Part.</p>  <p>NOTE</p> <ul style="list-style-type: none"> • Set the Message Display [Text Display]'s [Specify Text No.] to [Address], and [Data Type] to [Bin].
Offset	<p>Set the offset value for the Sub Display Screen No. from 0 to 8,999. The text designated as “[Sub Display Screen No.] in [Alarm Settings] + Offset value” will be displayed.</p>
Clearing Text No.	<p>When you select the [Sub Display Screen No.] in [Alarm Settings] to be Alarm Message “0”, the text designated here will be called and the previous text will be erased. Set the text number that has been created to clear the contents (such as text with no content) from 1 to 8,999.</p>

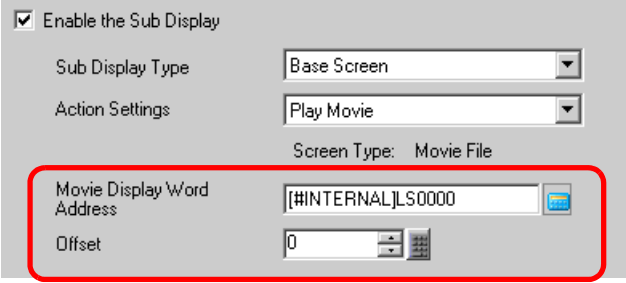
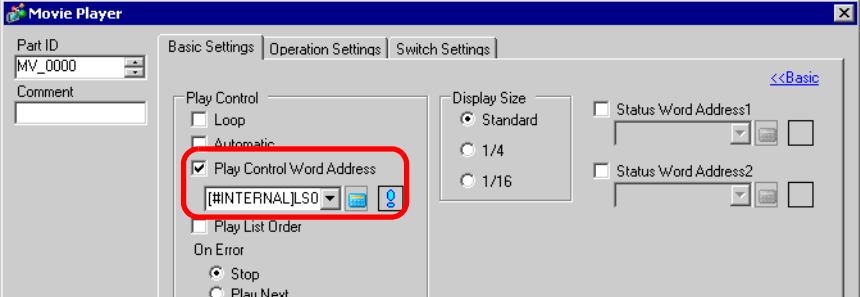
Setting	Description
<p>[Base Screen] - [Play Movie]</p>	<p>Switch to Base Screen set up with a Movie Player. This operation works the same as a normal screen change.</p> 
<p>Movie Display Word Address</p>	<p>Specifies the GP internal device address (LS area, USR area) that stores the [Sub Display Screen No.] as defined in the [Alarm Settings]. This number can act as the index number of the movie file to display in the movie player. Set the same address to the Movie Player's [Play Control Word Address] property.</p>  <p>NOTE</p> <ul style="list-style-type: none"> • In the Movie Player's [Play Mode] properties, set [Repeat Play] and [Auto Play] off and [Play List Order] to Individually, and set [On Error] to [Stop] .
<p>Offset</p>	<p>Set the Offset Value of the Sub Display Screen No. to 0-99. The number which was set at [Sub Display Screen No.] of [Alarm Settings] and the Movie File of the Index No. of the Offset Value will be displayed.</p>

Continued

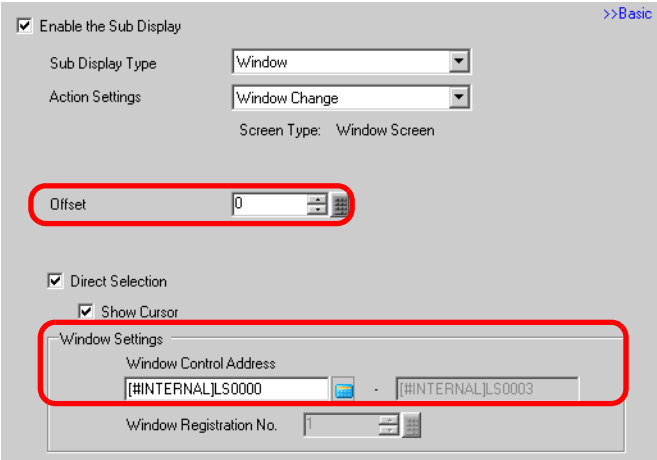
Setting	Description
<p>[Window] - [Window Change]</p>	<p>Displays the Window Screen which corresponds to the Alarm Message.</p> 
<p>Offset</p>	<p>Set the offset value for the Sub Display Screen No. from 0 to 2000. The screen designated as “[Sub Display Screen No.] in [Alarm Settings] + Offset value” will be displayed.</p>
<p>Window Settings</p>	<p>Configure settings to display a Window Part placed on the same screen as the Alarm Part.</p> <p>Specify the address to control the Window display. Four consecutive words will automatically be used, starting from the designated address. Only the address of the GP internal device (LS area, user area) can be used.</p> <p>The number set at [Sub Display Screen No.] in [Alarm Settings] is written to the address identified as “the address designated here + 1”, and treated as the Window Screen No. to be displayed.</p> <p>Set the same address to the [Window Control Address] of the Window Part placed on the same screen as the Alarm Part.</p> <p>☞ “18.7.2 Word Action” (page 18-23)</p> <p>NOTE</p> <ul style="list-style-type: none"> Set the Window Part’s [Window Specification] to [Address], and [Data Type] to [Bin].

Continued

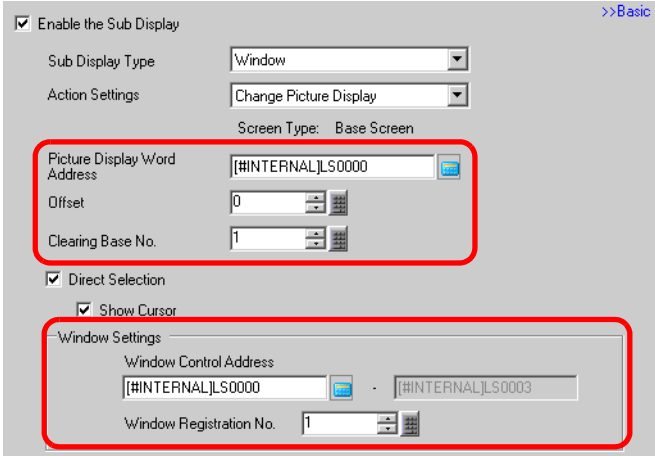
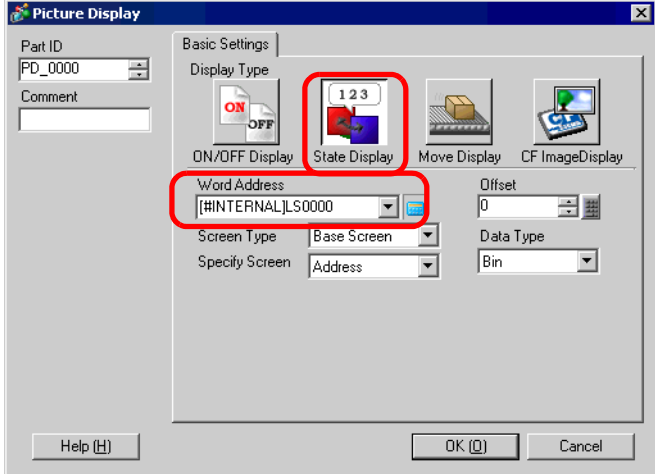
Setting	Description
<p>[Window] - [Change Picture Display]</p>	<p>Display a picture corresponding to the Alarm Message in the Picture Display placed on the Window Screen.</p> 
<p>Picture Display Word Address</p>	<p>Specify the address of the GP internal device (LS area, user area) to store the number which has been set in [Sub Display Screen No.] in [Alarm Settings]. The number stored in this address is the screen No. displayed on the Picture Display.</p> <p>Set the same address to the [Word Address] of the Picture Display placed on the Window Screen.</p>  <p>NOTE</p> <ul style="list-style-type: none"> Set the Picture Display's [Screen Type] to [Base Screen], [Specify Screen] to [Address], and [Data Type] to [Bin].
<p>Offset</p>	<p>Set the offset value for the Sub Display Screen No. from 0 to 9999. The screen designated as "[Sub Display Screen No.] in [Alarm Settings] + Offset value" will be displayed.</p>

Continued

Setting		Description
Change Picture Display	Clearing Base No.	When you select the [Sub Display Screen No.] in [Alarm Settings] to be Alarm Message “0”, the base screen designated here will be called and the previous screen will be erased. Set the screen number that has been created to clear the contents (such as a screen with a black-filled square) from 1 to 9,999.
	Window Settings	Configure settings to display a Window Part placed on the same screen as the Alarm Part.
	Window Control Address	<p>Specify the address to control the Window display. Four consecutive words will automatically be used, starting from the designated address. Only the address of the GP internal device (LS area, user area) can be used.</p> <p>Set the same address to the [Window Control Address] of the Window Part placed on the same screen as the Alarm Part.</p> <p> “18.7.2 Word Action” (page 18-23)</p> <p>NOTE</p> <ul style="list-style-type: none"> Set the Window Part’s [Window Specification] to [Address], and [Data Type] to [Bin].
Window Screen No.	Set the Window Screen No. to display (the window which contains the Picture Display) from 1 to 2,000. This number is written to the address identified as “designated [Window Control Address] + 1”.	

Continued

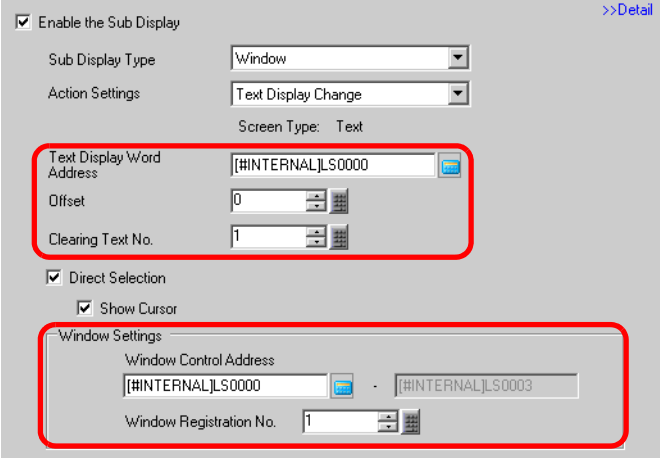
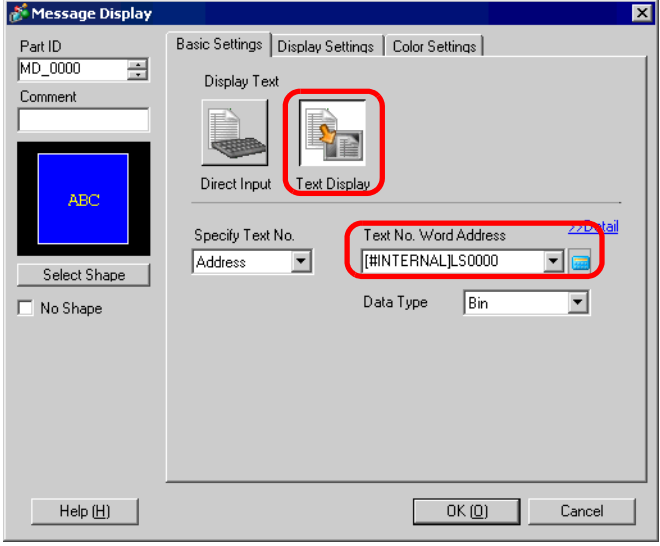
Setting	Description
<p>[Window] - [Text Display Change]</p>	<p>Display a text corresponding to the Alarm Message in the Message Display [Text Display] placed on the Window Screen.</p> 
<p>Text Display Word Address</p>	<p>Specify the address of the GP internal device (LS area, user area) to store the number which has been set in [Sub Display Screen No.] of [Alarm Settings]. The number stored in this address is the text No. displayed on the Message Display. Set the same address to the [Text No. Word Address] of the Message Display placed on the Window Screen.</p>  <p>NOTE</p> <ul style="list-style-type: none"> • Set the Message Display [Text Display]’s [Specify Text No.] to [Address], and [Data Type] to [Bin].
<p>Offset</p>	<p>Set the offset value for the Sub Display Screen No. from 0 to 8,999. The text designated as “[Sub Display Screen No.] in [Alarm Settings] + Offset value” will be displayed.</p>

Continued

Setting		Description
Text Display Change	Clearing Text No.	When you select the [Sub Display Screen No.] in [Alarm Settings] to be Alarm Message “0”, the text designated here will be called and the previous text will be erased. Set the text number that has been created to clear the contents (such as text with no content) from 1 to 8,999.
	Window Settings	Configure settings to display a Window Part placed on the same screen as the Alarm Part.
	Window Control Address	<p>Specify the address to control the Window display. Four consecutive words will automatically be used, starting from the designated address. Only the address of the GP internal device (LS area, user area) can be used.</p> <p>Set the same address to the [Window Control Address] of the Window Part placed on the same screen as the Alarm Part.</p> <p>☞ “18.7.2 Word Action” (page 18-23)</p> <p>NOTE</p> <ul style="list-style-type: none"> • Set the Window Part’s [Window Specification] to [Address], and [Data Type] to [Bin].
	Window Screen No.	Set the Window Screen No. to display (the window which contains the Message Display) from 1 to 2,000. This number is written to the address identified as “designated [Window Control Address] + 1”.

Continued

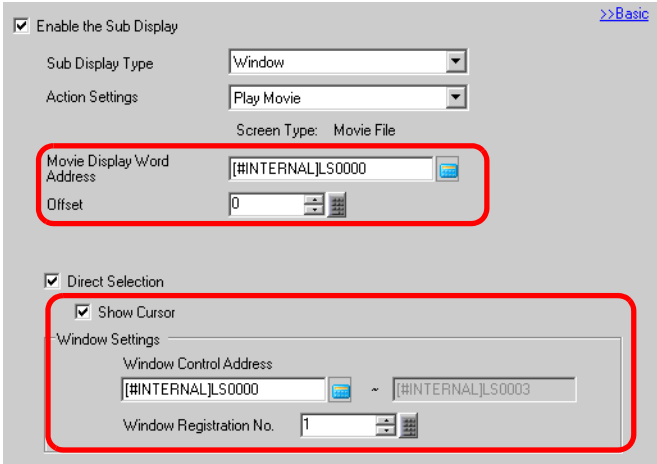
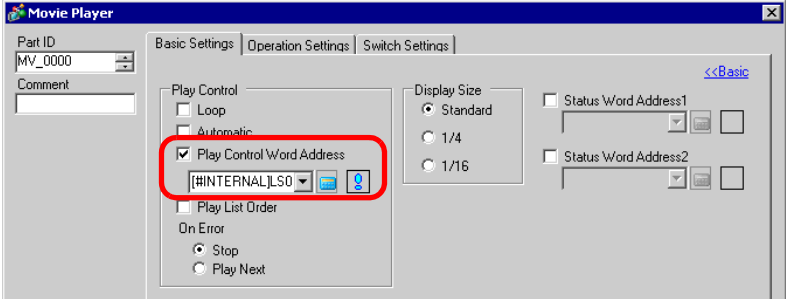
Setting	Description
<p>[Window] - [Play Movie]</p>	<p>Sub-display Movie Player that is positioned on the Window Screen.</p> 
<p>Movie Display Word Address</p>	<p>Specifies the GP internal device address (LS area, USR area) that stores the [Sub Display Screen No.] as defined in the [Alarm Settings]. This number can act as the index number of the movie file to display in the movie player. Set the same address to the Movie Player's [Play Control Word Address] property.</p>  <p>NOTE</p> <ul style="list-style-type: none"> • In the Movie Player's [Play Mode] properties, set [Repeat Play] and [Auto Play] off, [Play List Order] to [Individually], and set [On Error] to [Stop] .
<p>Offset</p>	<p>Set the Offset Value of the Sub Display Screen No. to 0-99. The number which was set at [Sub Display Screen No.] of [Alarm Settings] and the Movie File of the Index No. of the Offset Value will be displayed.</p>

Continued

Setting		Description
Play Movie	Window Settings	Configure settings to display a Window Part placed on the same screen as the Alarm Part.
	Window Control Address	<p>Specify the address to control the Window display. Four consecutive words will automatically be used, starting from the designated address. Only the address of the GP internal device (LS area, user area) can be used.</p> <p>The number set at [Sub Display Screen No.] in [Alarm Settings] is written to the address identified as “the address designated here + 1”, and treated as the Window Screen No. to be displayed.</p> <p>Set the same address to the [Window Control Address] of the Window Part placed on the same screen as the Alarm Part.</p> <p> “18.7.2 Word Action” (page 18-23)</p> <p>NOTE</p> <ul style="list-style-type: none"> Set the Window Part’s [Window Specification] to [Address], and [Data Type] to [Bin].
	Window Screen No.	Defines the number, from 1 to 2000, of the Window Screen (set up with a Movie Player) that you want to display. This number is written to ([Window Control Address]+1).

NOTE • The GP internal device [#INTERNAL] consists of two areas: the [LS] area and [USR] area. For the available addresses in the LS area, refer to the following:

 “A.1.4 LS Area (Direct Access Method)” (page A-8)

◆ **Switch Settings**

Set operation switches to display Alarm Messages.

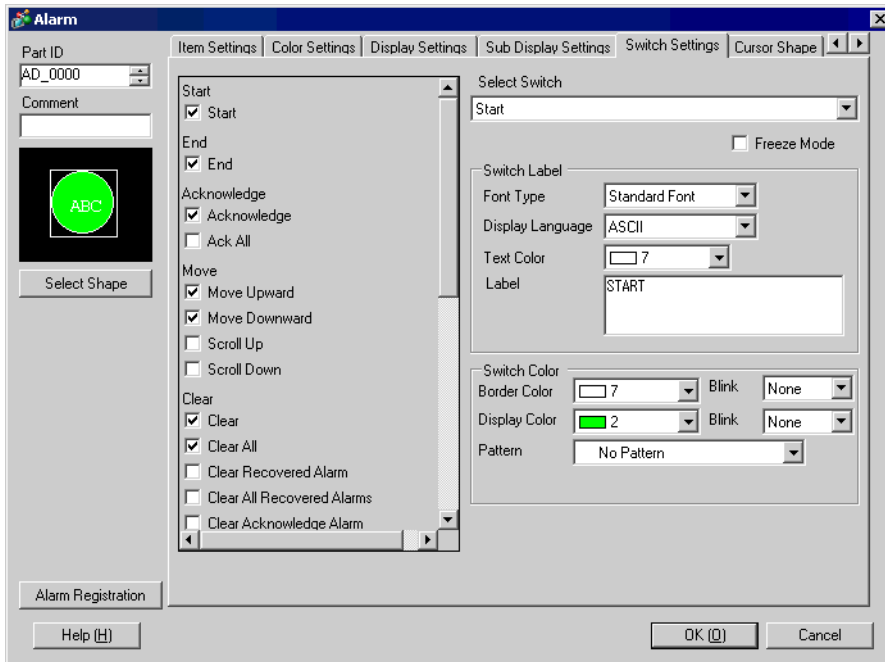

- NOTE** • The same Switch as the one set on this tab can be created with a Switch Lamp Part's [Special Switch] - [Alarm History Switch].
 ☞ "11.14.4 Special Switch ■ Switch Feature ◆ Alarm History Switch" (page 11-63)

Setting	Description
Switch Preview	Displays the selected switch's shape.
Select Shape	Open the Select Shape dialog box to choose the Part's shape.
Types of Switches	Set the Switch's type.
Start/End	Set a switch to start/end operation.
Start/End	Touch [Start] and the cursor will appear to operate the other switches. Touching [End] cancels the cursor.

Continued

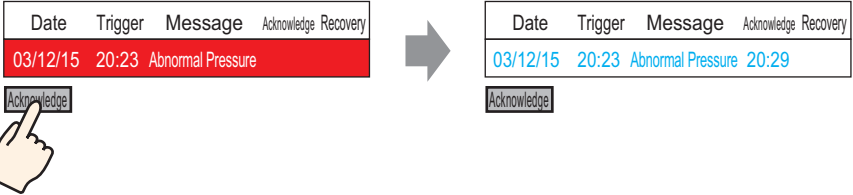
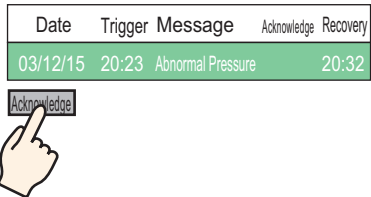
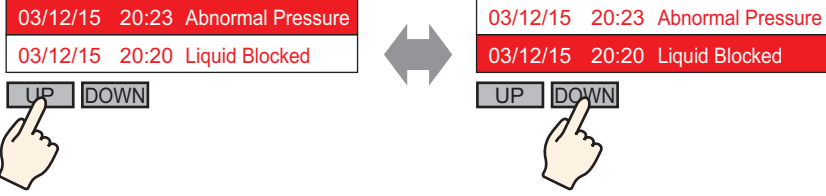
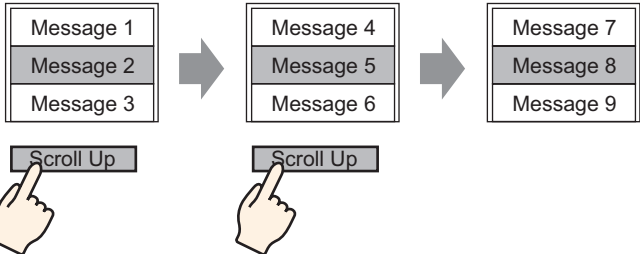
Setting	Description
Types of Switches	<p>Acknowledge</p> <p>Set the Acknowledge switch.</p>
	<p>Acknowledges the alarm in the cursor's current position. Press [Acknowledge] and the currently triggered Alarm Message's trigger time will be displayed.</p>  <p>Acknowledge</p> <p>Alarms that have already recovered will not change when [Acknowledge] is touched.</p>  <p>NOTE</p> <ul style="list-style-type: none"> • If an Alarm Message is already displayed with the acknowledge time, the time will not be updated.
	<p>Ack All</p> <p>Acknowledges all Alarm Messages that are currently triggered.</p>
	<p>Move</p> <p>Set the Move switches.</p>
<p>Move Upward</p>	<p>Moves the cursor 1 row up or down.</p> 
<p>Move Downward</p>	<p>Alarm Messages that are currently displayed are scrolled up or down by a given number of rows. e.g.: No. of Active Alarms: 9, No. of Display Lines: 3, No. of Scroll: 3</p> 

Continued

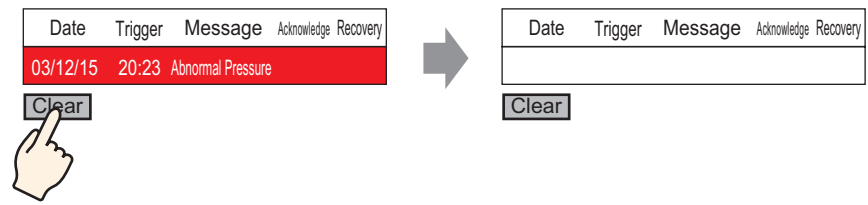
Setting		Description
Types of Switches	Clear	Set a switch to clear the display. The bit or word data of the host (PLC) will not be cleared.
	Clear	<p>Touch [Clear], and the Alarm Message display at the current cursor position is erased.</p> 
	Clear All	All displayed Alarm Messages are erased, regardless of whether they are in the [Trigger], [Acknowledge], or [Recovery] state.
	Clear Recovered Alarm	Erases the recovered alarm message at the current cursor position. The message is not erased if it is not in the Recovery state.
	Clear All Recovered Alarms	Erases all recovered Alarm Messages.
	Clear Acknowledge Alarm	Erases the acknowledged alarm message at the current cursor position. The message is not erased if it is not in the Acknowledge state.
	Clear All Acknowledge Alarms	Erases all Acknowledge Alarm Messages.
	Clear Individual No. of Occurrences	Clears the No. of Occurrences for the alarm in the cursor's current position and replace that value with "0".
	Clear All No. of Occurrences	Clears the No. of Occurrences for all displayed alarms and replace that value with "0".
	Clear Individual Accumulated Time	Clears the accumulated time for the alarm in the cursor's current position and replace that value with "0".
Clear All Accumulated Time	Clears the accumulated time for all displayed alarms and replace that value with "0".	

Continued

	Setting	Description
Types of Switches	Sort	Set a switch to sort Alarm Messages. NOTE <ul style="list-style-type: none"> This setting is disabled when the Display Mode is set to [Log]. Even when the display order of the messages changes on the screen, the Alarm History data is printed or saved to the CF-Card in the order of occurrence.
	In Reverse Order of Trigger Date	Displays Alarm Messages in the order of occurrence, according to the scroll direction.
	In No. of Occurrences Order	Displays Alarm Messages in the order starting with the largest occurrence frequency, according to the scroll direction. NOTE <ul style="list-style-type: none"> If multiple alarms with the same frequency exist, they will display in the decreasing order of the accumulated time, according to the scroll direction. If multiple alarms have the same frequency and accumulated time, the newest alarm will display first.
	In Descending Order of Accumulated Time	Displays Alarm Messages in the order starting with the largest accumulated time, according to the scroll direction. NOTE <ul style="list-style-type: none"> If multiple alarms with the same accumulated time exist, they will display in the decreasing order of the number of occurrences, according to the scroll direction. If multiple alarms have the same number of occurrences and accumulated time, the newest alarm will display first.
	Level & In Reverse Order of Trigger Date	Displays Alarm Messages in the order starting with the highest registered level, according to the scroll direction. If multiple Alarm Messages with the same level exist, messages will display in the order starting with the latest occurrence date.
	Level & In Descending Order of No. of Occurrences	Displays Alarm Messages in the order starting with the highest registered level, according to the scroll direction. If multiple Alarm Messages with the same level exist, messages will display in the decreasing order of the alarm frequency, according to the scroll direction. NOTE <ul style="list-style-type: none"> If multiple alarms with the same frequency exist, they will display in the decreasing order of the accumulated time.
	Alarm Registration Order	Displays Alarm Messages in ascending order of the registration number (Row No.) set in [Alarm Settings], according to the scroll direction.
	Reverse Order	Displays Alarm Messages in the reverse order of the specified sorting order.

Continued

Setting		Description												
Sub Display	Sub Display	Set the Sub Display switch.												
	Sub Display	Displays the sub screen registered to the Alarm Message at the current cursor position.												
	Alarm No. Acquisition	Set the Alarm No. Acquisition switch.												
	Alarm No. Acquisition	Obtains the Alarm Message No. (the row number registered in [Alarm Settings]) of the message at the current cursor position.												
Select Switch		Choose a switch to set the label or scroll count.												
No. of Samples to Scroll		Set the number of rows to scroll up or down from 1 to 768 when you place the [Scroll Up]/[Scroll Down] switch.												
Freeze Mode	Specify whether to use Freeze Mode when you place the [Start] switch. Freeze Mode suspends the currently displayed alarms and prohibits the screen display from refreshing. This can be used to temporarily stop the display when alarms are triggered too often to be seen. When Freeze Mode is set, touch [Start] twice to begin freeze mode, and touch [End] to cancel it.													
	When the following operations are performed in freeze mode, the management and display will be as follows.													
	<table border="1"> <thead> <tr> <th>Action/Switch operation</th> <th>Management</th> <th>Display</th> </tr> </thead> <tbody> <tr> <td>Alarm: Trigger, Recovery Switch Operation: [Acknowledge], [Clear]</td> <td>O</td> <td>×</td> </tr> <tr> <td>Switch Operation: [Move Upward], [Move Downward], [Scroll Up], [Scroll Down], [Sort], [Sub Display]</td> <td>O</td> <td>O</td> </tr> <tr> <td>Switch Operation: [Alarm No. Acquisition Key]</td> <td>O</td> <td>—</td> </tr> </tbody> </table>		Action/Switch operation	Management	Display	Alarm: Trigger, Recovery Switch Operation: [Acknowledge], [Clear]	O	×	Switch Operation: [Move Upward], [Move Downward], [Scroll Up], [Scroll Down], [Sort], [Sub Display]	O	O	Switch Operation: [Alarm No. Acquisition Key]	O	—
	Action/Switch operation	Management	Display											
Alarm: Trigger, Recovery Switch Operation: [Acknowledge], [Clear]	O	×												
Switch Operation: [Move Upward], [Move Downward], [Scroll Up], [Scroll Down], [Sort], [Sub Display]	O	O												
Switch Operation: [Alarm No. Acquisition Key]	O	—												
<p>NOTE</p> <ul style="list-style-type: none"> Note that executing a clear while Freeze Mode is activated will clear the messages stored inside the GP, even though the messages remain on the display. When the message stored in the GP has been cleared as mentioned above, that message's sub display is not displayed in the Freeze Mode. 														
Switch Label		Set the text to display on the switch's label.												
Font Type		Choose a font type for the switch's label from [Standard Font] or [Stroke Font].												
Display Language		Select a language for the Switch Label from [Japanese], [Western], [Chinese (Traditional)], [Chinese (Simplified)], [Korean], [Cyrillic], or [Thai].												
Text Color		Select a color for the switch's label.												
Label		Input the text to display on the switch's label.												

Continued

Setting	Description
Switch Color	Set the Switch's color.
Border Color	Designate the switch's border color and background color.
Display Color	<p>NOTE</p> <ul style="list-style-type: none"> The Switch Color setting is common to all Alarm parts, regardless of the switch type selected.
Blink	<p>Select whether or not the Switch will blink, and the blink speed. You can choose different blink settings for the [Border Color], [Display Color], and [Pattern Color].</p> <p>NOTE</p> <ul style="list-style-type: none"> There are cases where you can and cannot set Blink depending on the Main Unit and System Settings' [Color Settings].  "9.5.1 Setting Colors ■ List of Available Colors" (page 9-34)
Pattern	Select the switches' pattern from 9 types.
Pattern Color	Specify the pattern color when you select options other than [No Pattern].

◆ **Cursor Shape**

If handling Alarm Messages, choose the cursor's display shape. Also, select cursor settings for when the Alarm Message confirmation is sent from the device/PLC.

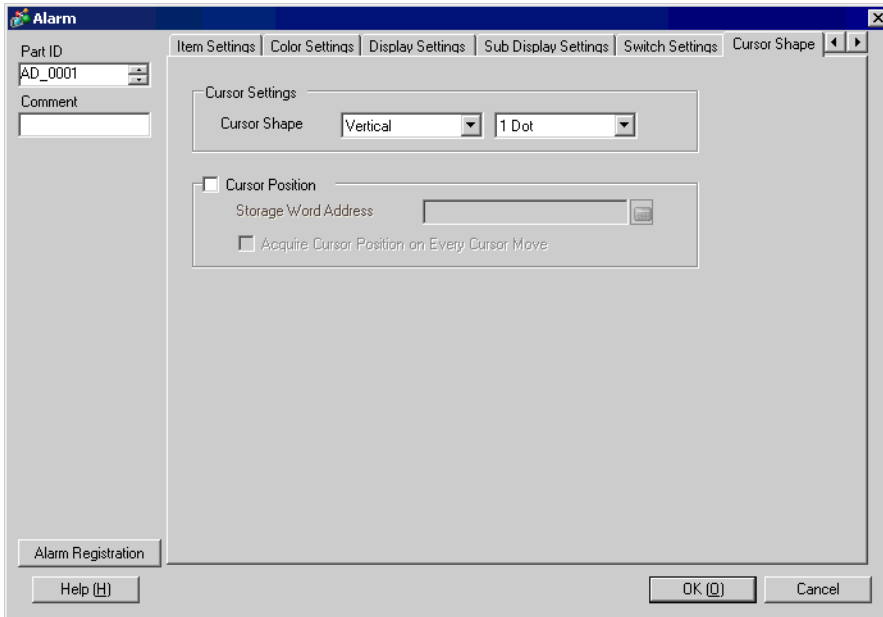

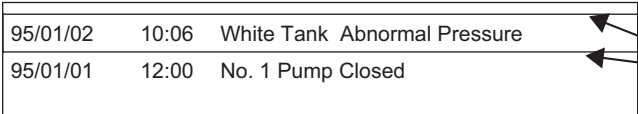
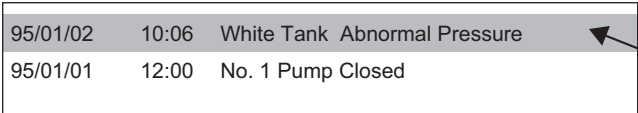
Setting	Description
Cursor Settings	If handling Alarm Messages, choose the cursor's display shape.
Cursor Shape	<p>Choose the cursor shape from [Vertical] or [Reverse].</p> <p>Up/Down</p>  <p>Reverse</p> 
No. of Dots	If the cursor shape is [Vertical], choose the cursor thickness from [1 dot] or [2 dots].

Continued

Setting	Description
Cursor Position	Configure settings for the notification of the registration number (Row No.) of the Alarm Message selected with the cursor.
Storage Word Address	<p>Set the address where the registration number (Row No.) of the selected Alarm Message will be stored.</p> <p>When Alarm Messages are registered with [Bit Monitoring], the value of the registration number (Row No.) will be directly stored. When Alarm Messages are registered with [Word Monitoring], the value of “the registration number (Row No.) + 10,000”. will be stored.</p> <p>e.g.: When an Alarm Message is registered with Word Monitoring and the registration number (Row No.) of the Alarm Message is 152: Value stored in the [Storage Word Address] = 152 + 10000 = 10152</p> <p>NOTE</p> <ul style="list-style-type: none"> • While in [Freeze Mode], the notification of the current cursor position for cleared data is not provided.
Acquire Cursor Position on Every Cursor Move	<p>Automatically stores the Alarm Message’s registration number (Row No.) to [Storage Word Address] every time the cursor moves.</p> <p>NOTE</p> <ul style="list-style-type: none"> • To provide the notification of the alarm cursor position without designating this option, you need to place the [Alarm No. Acquisition Key] switch.

■ **Summary**

Alarm Messages that are currently triggered are displayed in a list.

◆ **Basic Settings**

Set the format of the Alarm Summary display.

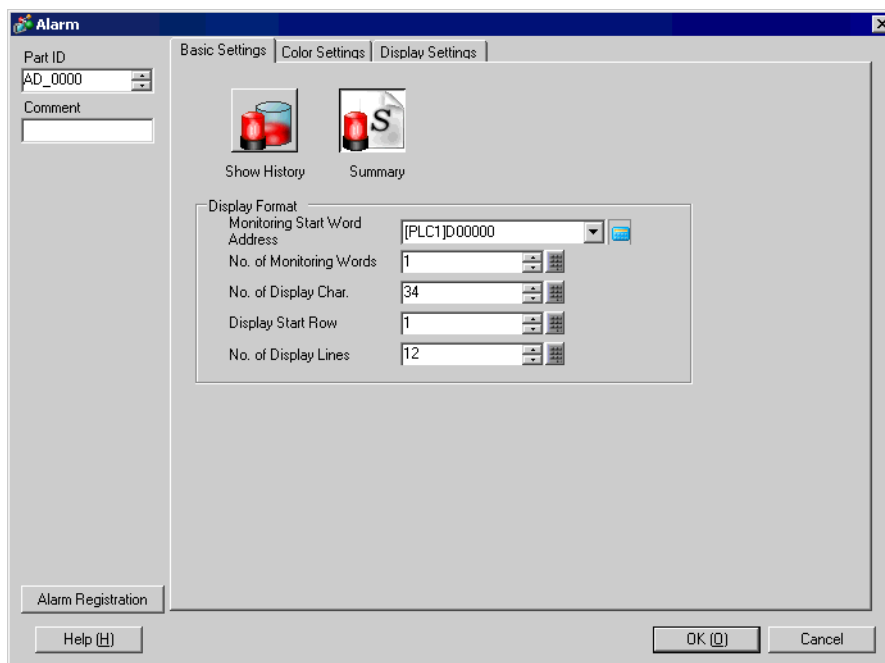

Setting	Description
Display Format	Set the format of the Alarm Summary display.
Monitoring Start Word Address	Set the top address of the monitoring bit for the Alarm Message designated in [Alarm Settings].
No. of Monitoring Words	Set the number of words allotted for the Monitoring Bits from 1 to 100. NOTE <ul style="list-style-type: none"> For the number of monitoring words, 1 word is treated as 16 bits. For 32 bit devices, set the number of monitoring words to multiples of 2 (2, 4, 6, and so on).
No. of Display Char.	Set the maximum number of Alarm Message characters that can display on one row from 1 to 100.

Continued

Setting	Description
<p style="writing-mode: vertical-rl; transform: rotate(180deg);">Display Format</p> <p>Display Start Row</p>	<p>Designate the row of the currently active Alarm Messages to start a display from 1 to 1,600.</p> <p>When multiple alarms are triggered, the extra rows that did not fit into a single Alarm part can be seen by setting a different display start row for several Alarm parts.</p> <div style="text-align: center;"> </div>
<p>No. of Display Lines</p>	<p>Set how many Alarm Message rows will display at maximum on one screen from 1 to 50.</p>

◆ **Color Settings**

Select the color when the Alarm Message is not displayed. (The Alarm Message’s text color and background color are designated in [Alarm Settings].)

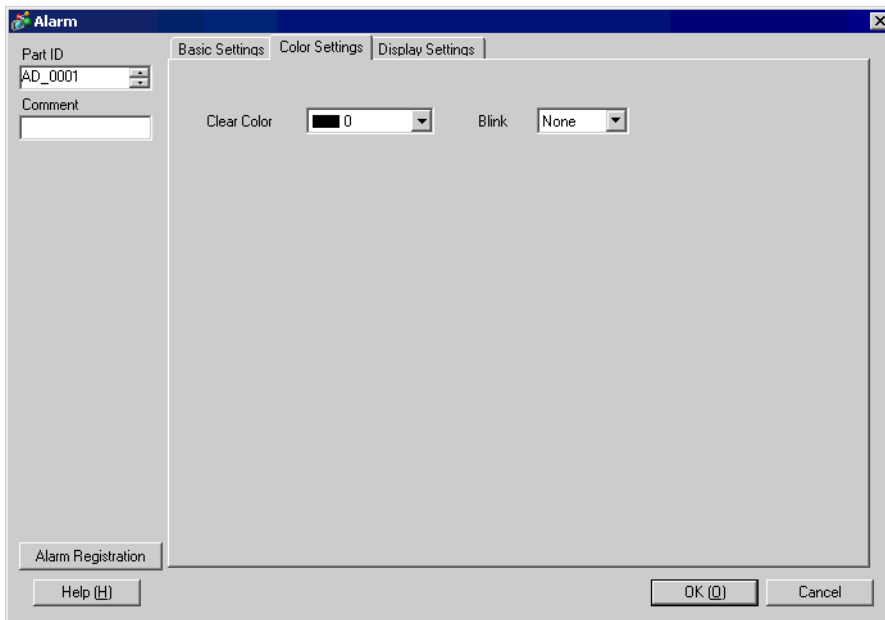

Setting	Description
Clear Color	Select a color used when an Alarm Message is cleared (or not displayed). NOTE • The Alarm Message’s text color and background color are designated in [Alarm Settings].
Blink	Select whether or not the Switch will blink, and the blink speed. You can choose blink settings for [Clear Color]. NOTE • There are cases where you can and cannot set Blink depending on the Main Unit and System Settings’ [Color Settings]. ☞ “9.5.1 Setting Colors ■ List of Available Colors” (page 9-34)

◆ **Display Settings**

Set a font and border for the Alarm Message.

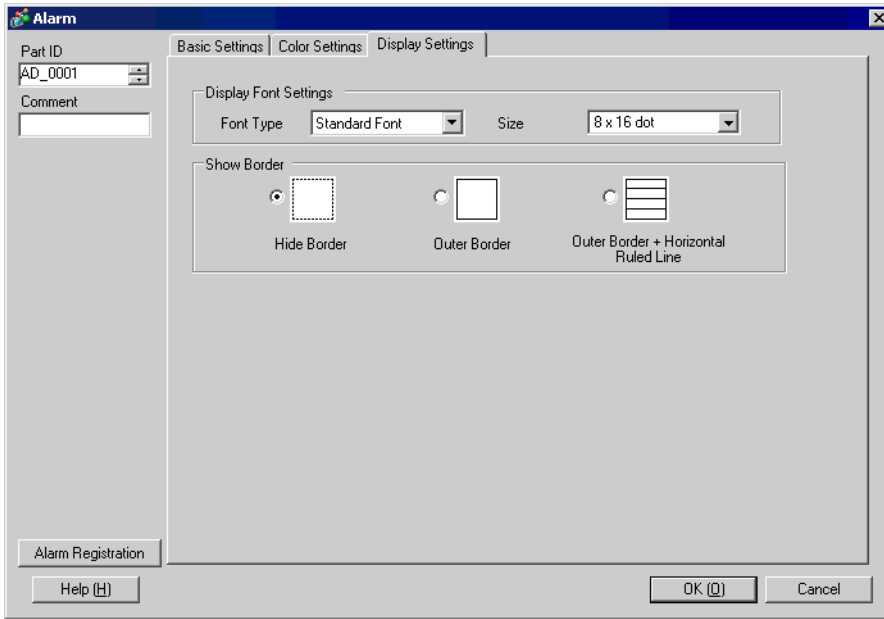

Setting	Description
Display Font Settings	Configure font settings.
Font Type	Choose a font type for the Alarm Message from [Standard Font] or [Stroke Font].
Character Size	Choose a font size for the Alarm Message. Standard Font: Specify “Width × Height” within the range between [8 × 8] to [64 × 128] in the unit of 8 dots, or select a fixed size from [6 × 10], [8 × 13], [13 × 23]. The fixed sizes can be selected for displaying single-byte alphanumeric characters only. Stroke Font: 6 to 127
Show Border	Choose the Alarm Message’s border from [Hide Border], [Outer Border], or [Outer Border + Horizontal Ruled Line]. NOTE <ul style="list-style-type: none"> The color of the border and ruled line is fixed to white.

19.9.3 Setting Up Text Alarm Parts

■ Text Alarm

A Message registered on a Text Screen is displayed by each row. (It does not need to be registered in Common Settings [Alarm Settings].)

Among the Messages registered as a batch on a Text Screen, only the necessary rows are listed on the screen. Each message can be displayed as a Sub Screen so this is useful for showing troubleshooting guides.

☞ “19.10.4 Text Alarm Restrictions on Parts” (page 19-146)

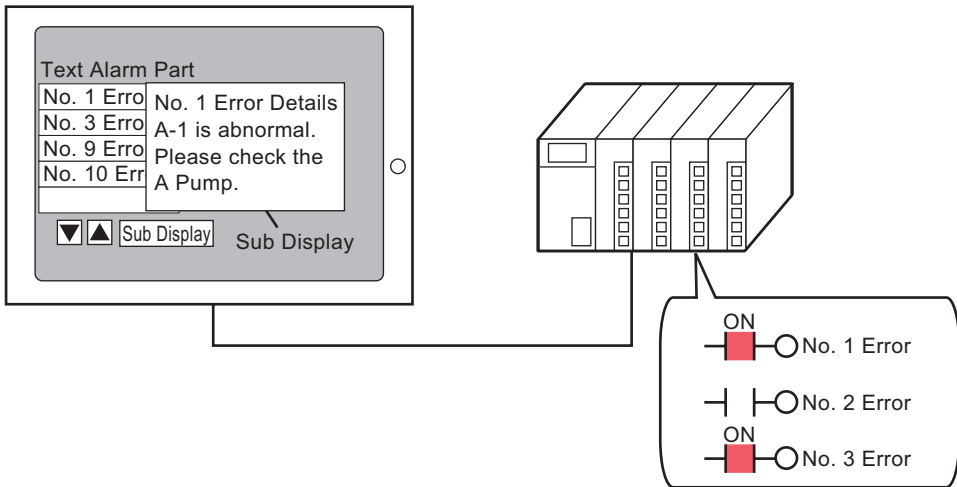

When the bit turns ON, the message is displayed. When the bit turns OFF, the message is erased.

◆ **Basic Settings**

Configure settings to display alarm messages registered on a Text Screen.

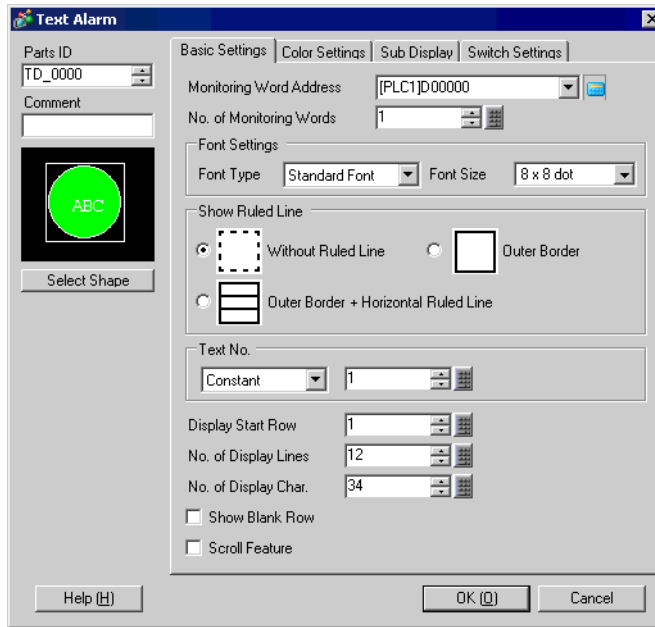

Setting	Description				
Monitoring Word Address	<p>Set the word which contains the monitoring bit's top address. When the Monitoring Word Address is set, one monitoring bit is automatically allotted to each row of the text.</p>				
No. of Monitoring Words	<p>Set the number of words allotted for the Monitoring Bits from 1 to 32. Set the number according to the number of rows inputted in the text. When the device address is expressed as 32 bits, one address contains two words.</p>				
Font Settings	<p>Set a font for the Alarm Message to be displayed.</p> <table border="1" data-bbox="155 1464 1263 1765"> <tr> <td data-bbox="155 1464 374 1547">Font Type</td> <td data-bbox="374 1464 1263 1547">Choose a font type for the Alarm Message from [Standard Font] or [Stroke Font].</td> </tr> <tr> <td data-bbox="155 1547 374 1765">Font Size</td> <td data-bbox="374 1547 1263 1765"> Choose a font size for the Alarm Message. Standard Font: Specify "Width × Height" within the range between [8 × 8] to [64 × 128] in the unit of 8 dots, or select a fixed size from [6 × 10], [8 × 13], [13 × 23]. The fixed sizes can be selected for displaying single-byte alphanumeric characters only. Stroke Font: 6 to 127 </td> </tr> </table>	Font Type	Choose a font type for the Alarm Message from [Standard Font] or [Stroke Font].	Font Size	Choose a font size for the Alarm Message. Standard Font: Specify "Width × Height" within the range between [8 × 8] to [64 × 128] in the unit of 8 dots, or select a fixed size from [6 × 10], [8 × 13], [13 × 23]. The fixed sizes can be selected for displaying single-byte alphanumeric characters only. Stroke Font: 6 to 127
Font Type	Choose a font type for the Alarm Message from [Standard Font] or [Stroke Font].				
Font Size	Choose a font size for the Alarm Message. Standard Font: Specify "Width × Height" within the range between [8 × 8] to [64 × 128] in the unit of 8 dots, or select a fixed size from [6 × 10], [8 × 13], [13 × 23]. The fixed sizes can be selected for displaying single-byte alphanumeric characters only. Stroke Font: 6 to 127				

Continued

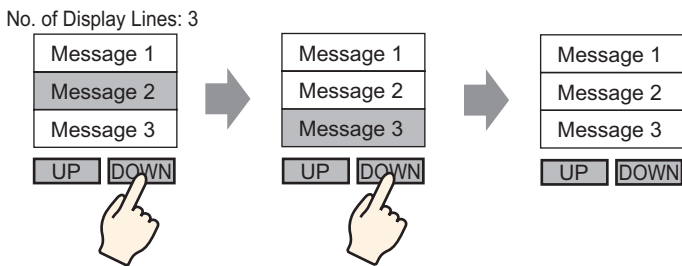
Setting	Description
Show Ruled Line	Choose the ruled line of the Text Alarm Part from [Without Ruled Line], [Outer Border], or [Outer Border + Horizontal Ruled Line]. NOTE <ul style="list-style-type: none"> The color of the border and ruled line is fixed to white.
Text No.	Set the text No. of the text to be displayed.
Constant/ Address	Select the designation method of the text No. from [Constant] or [Address]. <ul style="list-style-type: none"> Constant Designate a set constant as the Text No. (Direct Specification) Address Specify the address where the Text No. will be stored. (Indirect Specification)
Text Screen No.	Set the text No. from 1 to 8,999.
Display Start Row	Designate the row of the currently active Alarms to start a display from 1 to 512. NOTE <ul style="list-style-type: none"> When [Show Blank Row] is selected, the maximum number of rows is 512 including blank rows.
No. of Display Lines	Set how many Alarm Message rows will display at maximum on one screen from 1 to 50.
No. of Display Char.	Set the maximum number of Alarm Message characters that can display on one row from 1 to 100.
Show Blank Row	Specify whether to display any blank lines in the text as an Alarm Message.
Scroll Feature	Set whether to use the scroll feature or not. When the scroll feature is not used, touching the cursor moving switch does not move the cursor to the messages out of the display area, and the cursor disappears.  <p style="text-align: center;">No. of Display Lines: 3</p>

◆ **Color Settings**

Set the color of the Alarm Message.

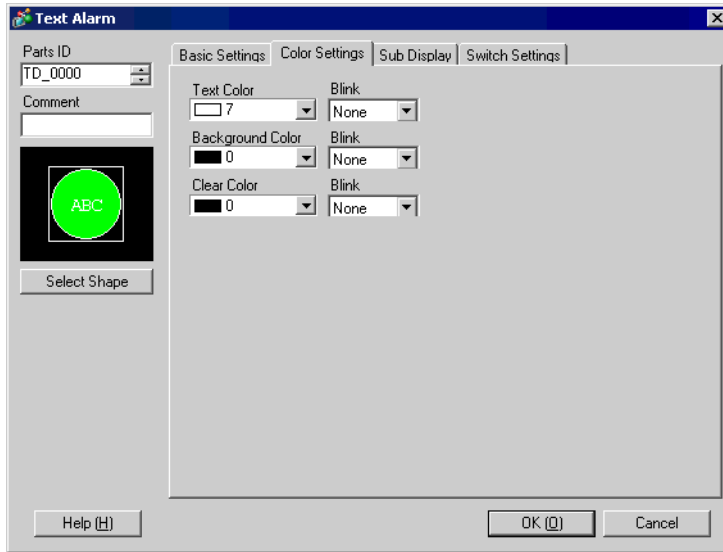

Setting	Description
Text Color	Select a color for the message's text.
Background Color	Select a background color for the message's text.
Clear Color	Select a color used when an Alarm Message is cleared (or not displayed).
Blink	<p>Select whether or not the Part will blink, and the blink speed. You can choose different blink settings for [Text Color], [Background Color], and [Clear Color].</p> <p>NOTE</p> <ul style="list-style-type: none"> There are cases where you can and cannot set Blink depending on the Main Unit and System Settings' [Color Settings]. <small>☞ "9.5.1 Setting Colors ■ List of Available Colors" (page 9-34)</small>

◆ **Sub Display/Basic**

Configure settings to display a sub screen corresponding to each Alarm Message.

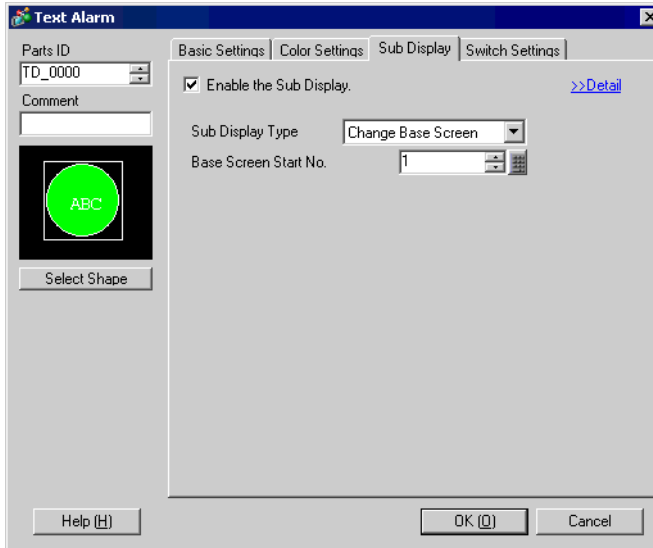

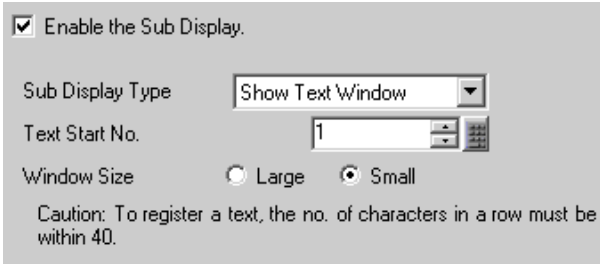
Setting	Description
Enable the Sub Display	Select whether or not to use a Sub Display.
Sub Display Type	<p>Select the Sub Display's Type.</p> <ul style="list-style-type: none"> • Change Base Screen This setting changes the entire screen to another screen. It works the same as a normal screen change. • Show Text Window Display the registered text in a Window. 
Base Screen Start Address	When setting [Sub Display Type] to [Change Base Screen], set the Start Base Screen No. to change screens with the Sub Display from 1 to 9,999.
Text Start No.	When setting [Sub Display Type] to [Show Text Window], set the Start Text No. to display in the Sub Screen from 1 to 8,999.

Continued

Setting	Description
Window Size	<p>When the [Sub Display Type] is [Show Text Window], choose the window's size to display text from [Large] or [Minor].</p> <p>NOTE</p> <ul style="list-style-type: none">• The maximum number of text characters on one line of a window is as follows. Large Window Size: Up to 30 characters, Minor Window Size: Up to 20 characters

◆ **Sub Display/Detail**

Configure settings to change a Base or Window Screen into a Sub Screen, or to use a Picture Display or a Message Display to display a sub screen on a Base or Window Screen.

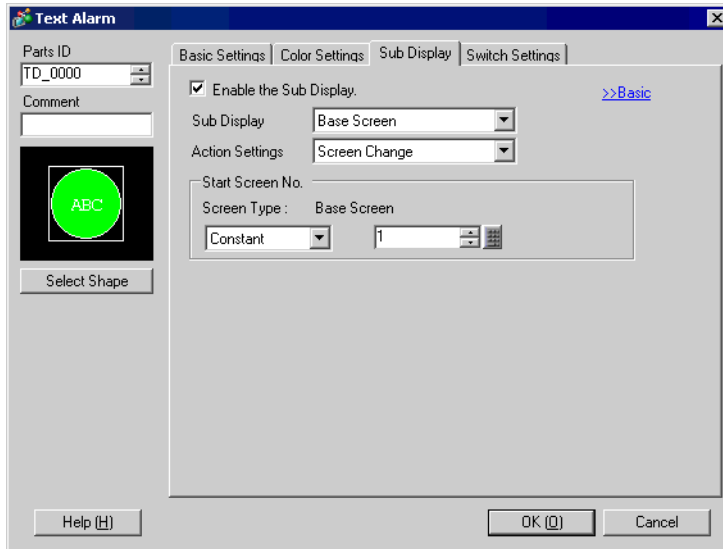

Setting	Description
Enable the Sub Display	Select whether or not to use a Sub Display.
Sub Display Type	Select the Sub Display's Type. <ul style="list-style-type: none"> • Base Screen Change the display to other screen, or display pictures or text on a base screen. • Window Display a Sub Screen in a Window. Change the window to another one, or display a picture or text in the Window.
Action Settings	Select the Sub Display's action type. <p>“When [Base Screen] is selected for [Sub Display]”</p> <ul style="list-style-type: none"> • Screen Change Change the Base Screen to display the sub screen. • Change Picture Display Use a Picture Display to display the sub screen. • Text Display Change Use a Message Display to display the sub screen. <p>“When [Window] is selected for [Sub Display]”</p> <ul style="list-style-type: none"> • Window Change Change the Window Screen to display the sub screen. • Change Picture Display Use a Picture Display on the Window Screen to display the sub screen. • Text Display Change Use a Message Display on the Window Screen to display the sub screen.

Continued

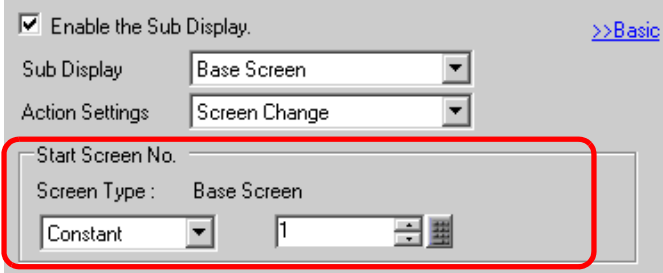
Setting	Description
<p>[Base Screen] - [Screen Change]</p>	<p>This setting changes the entire screen to another screen. This operation works the same as a normal screen change.</p> 
<p>Start Screen No.</p>	<p>Set the Base Screen's Start No. to display a sub screen. Select the method to designate the screen No. from [Constant] or [Address].</p> <ul style="list-style-type: none"> • Constant Designate a set constant as the Base Screen's Start No. The value can be from 1 to 9,999. • Address Select a word address that stores the Base Screen's Start No.

Continued

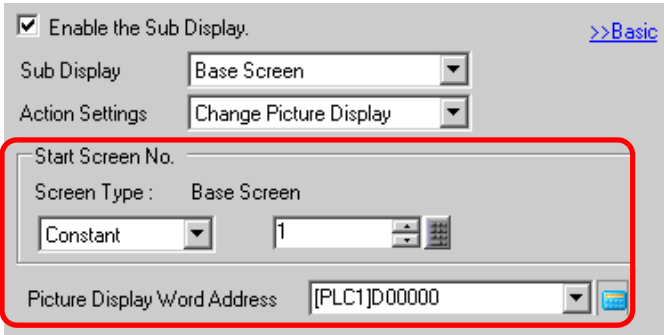
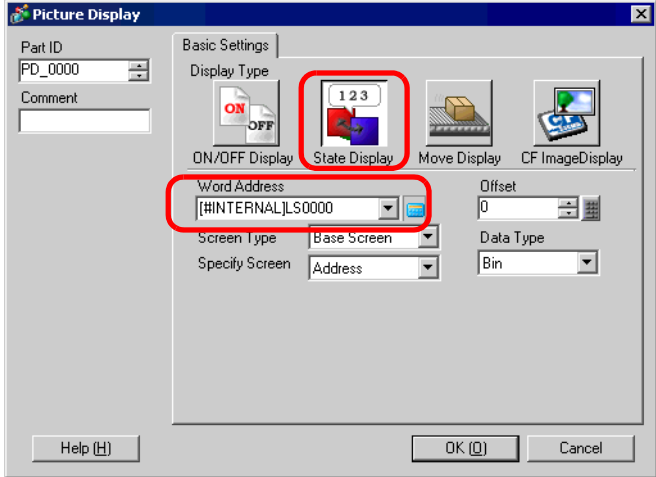
Setting	Description
<p>[Base Screen] - [Screen Change]</p>	<p>Display a picture corresponding to the Alarm Message in the Picture Display placed on the same screen as the Text Alarm Part.</p> 
<p>Start Screen No.</p>	<p>Set the start number of the Base Screen for the sub display in the Picture Display Select the method to designate the screen No. from [Constant] or [Address].</p> <ul style="list-style-type: none"> • Constant Designate a set constant as the start No. of the screen used for picture display. The value can be from 1 to 9,999. • Address Select a word address that stores the start No. of the screen used for picture display.
<p>Picture Display Word Address</p>	<p>Set a word address to store the screen No. of the screen displayed in a Picture Display. Set the same address as the [Word Address] of the Picture Display placed on the same screen as the Text Alarm Part.</p>  <p>NOTE</p> <ul style="list-style-type: none"> • In a Picture Display set to [State Display], set the [Screen Type] to [Base Screen], [Specify Screen] to [Address], and [Data Type] to [Bin].

Continued

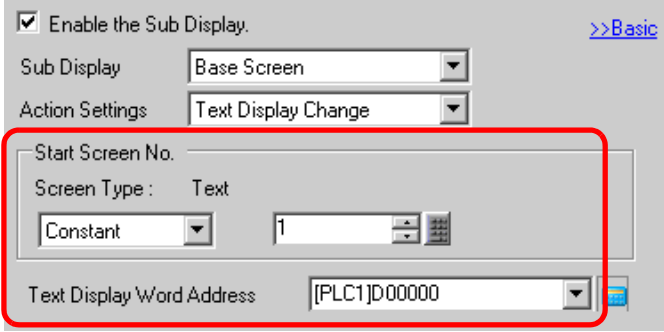
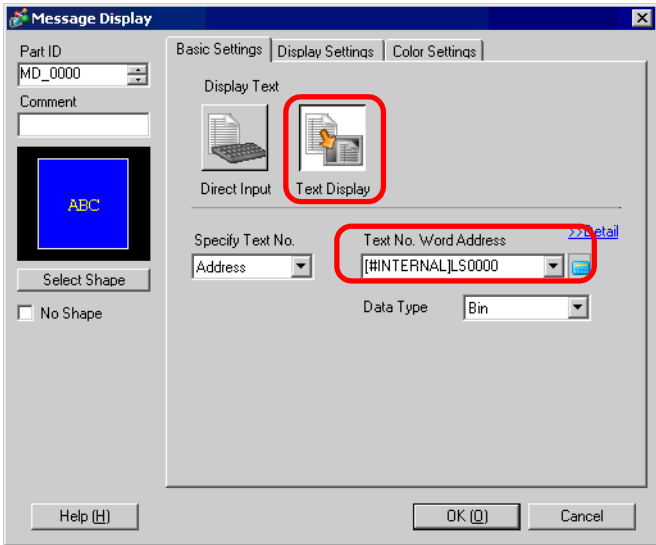
Setting	Description
<p>[Base Screen] - [Text Display Change]</p>	<p>Display a text corresponding to the Alarm Message in the Message Display placed on the same screen as the Text Alarm Part.</p> 
<p>Start Screen No.</p>	<p>Sets up the start number for the sub display's text that will appear in the "Message Display". Select the method to designate the text No. from [Constant] or [Address].</p> <ul style="list-style-type: none"> • Constant Designate a set constant as the Text's Start No. The value can be from 1 to 8,999. • Address Select a word address that stores the Text's Start No.
<p>Text Display Word Address</p>	<p>Set a word address to store the Text No. of the text displayed in a Message Display. Set the same address as the [Text No. Word Address] of the Message Display placed on the same screen as the Text Alarm Part.</p>  <p>NOTE</p> <ul style="list-style-type: none"> • Set the Message Display [Text Display]'s [Specify Text No.] to [Address], and [Data Type] to [Bin].

Continued

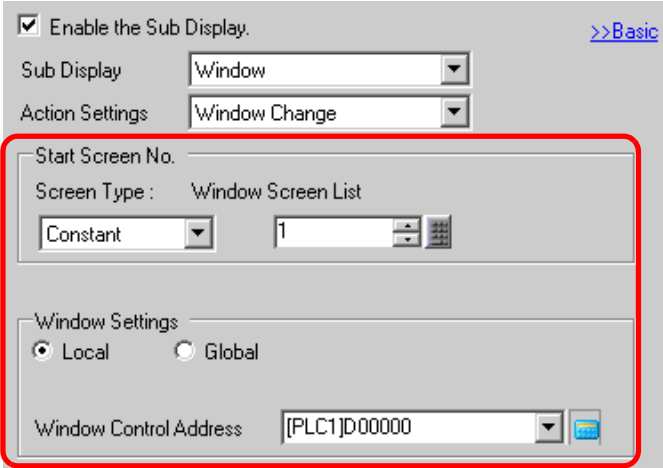
Setting	Description				
[Window] - [Window Change]	<p>Displays the Window Screen which corresponds to the Alarm Message.</p> 				
Start Screen No.	<p>Display a sub display Sets the start number of the Window Screen Select the method to designate the Window Screen No. from [Constant] or [Address].</p> <ul style="list-style-type: none"> • Constant Designate a set constant as the start No. of the Window Screen used for a Sub Display. The value can be from 1 to 2,000. • Address Set the address where the Start Screen No. of the Window Screen used for a Sub Display is stored. 				
Window Settings	<p>Configure the Window's settings.</p> <table border="1" data-bbox="203 1089 1266 1721"> <tr> <td data-bbox="203 1089 375 1373">Local/Global</td> <td data-bbox="375 1089 1266 1373"> <p>Sub Display using a Local Window or Specify whether to create a Global Window.</p> <p>NOTE</p> <ul style="list-style-type: none"> • To use a global window, refer to “18.6.2 Setup Procedure” (page 18-18) . On the [System Settings Window] - [Main Unit Settings] - [Action Settings] tab, set [Global Window Operation] to [Indirect], and [Data Type] to [Bin]. Use LS16 to display or erase the Window. </td> </tr> <tr> <td data-bbox="203 1373 375 1721">Window Control Address</td> <td data-bbox="375 1373 1266 1721"> <p>To use a local window for a Sub Display, designate the address used to control the window display. Four consecutive words will automatically be used, starting from the designated address. Set the same address as the [Window Control Address] of the Window Part placed on the same screen as the Text Alarm Part. ☞ “18.7.2 Word Action” (page 18-23)</p> <p>NOTE</p> <ul style="list-style-type: none"> • Set the Window Part's [Window Specification] to [Address], and [Data Type] to [Bin]. </td> </tr> </table>	Local/Global	<p>Sub Display using a Local Window or Specify whether to create a Global Window.</p> <p>NOTE</p> <ul style="list-style-type: none"> • To use a global window, refer to “18.6.2 Setup Procedure” (page 18-18) . On the [System Settings Window] - [Main Unit Settings] - [Action Settings] tab, set [Global Window Operation] to [Indirect], and [Data Type] to [Bin]. Use LS16 to display or erase the Window. 	Window Control Address	<p>To use a local window for a Sub Display, designate the address used to control the window display. Four consecutive words will automatically be used, starting from the designated address. Set the same address as the [Window Control Address] of the Window Part placed on the same screen as the Text Alarm Part. ☞ “18.7.2 Word Action” (page 18-23)</p> <p>NOTE</p> <ul style="list-style-type: none"> • Set the Window Part's [Window Specification] to [Address], and [Data Type] to [Bin].
Local/Global	<p>Sub Display using a Local Window or Specify whether to create a Global Window.</p> <p>NOTE</p> <ul style="list-style-type: none"> • To use a global window, refer to “18.6.2 Setup Procedure” (page 18-18) . On the [System Settings Window] - [Main Unit Settings] - [Action Settings] tab, set [Global Window Operation] to [Indirect], and [Data Type] to [Bin]. Use LS16 to display or erase the Window. 				
Window Control Address	<p>To use a local window for a Sub Display, designate the address used to control the window display. Four consecutive words will automatically be used, starting from the designated address. Set the same address as the [Window Control Address] of the Window Part placed on the same screen as the Text Alarm Part. ☞ “18.7.2 Word Action” (page 18-23)</p> <p>NOTE</p> <ul style="list-style-type: none"> • Set the Window Part's [Window Specification] to [Address], and [Data Type] to [Bin]. 				

Continued

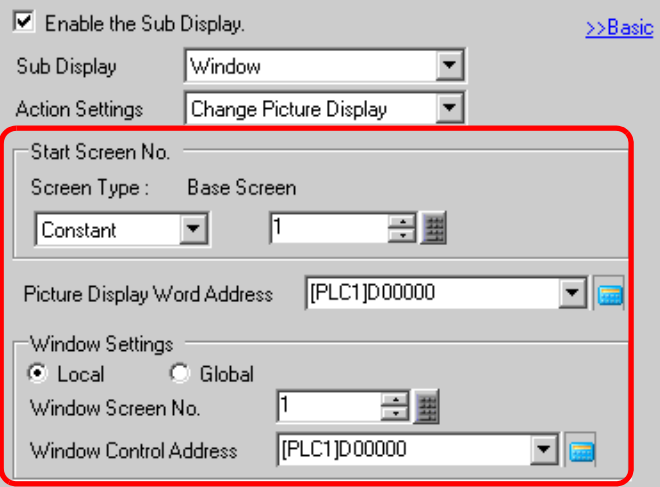
Setting	Description
[Window] - [Change Picture Display]	<p>Display a picture corresponding to the Alarm Message in the Picture Display placed on the Window Screen.</p> 
Start Screen No.	<p>Set the Base Screen's Start No. to display a sub screen for a Picture Display on the Window Screen. Select the method to designate the screen No. from [Constant] or [Address].</p> <ul style="list-style-type: none"> • Constant Designate a set constant as the start No. of the screen used for picture display. The value can be from 1 to 9,999. • Address Select a word address that stores the start No. of the screen used for picture display.

Continued

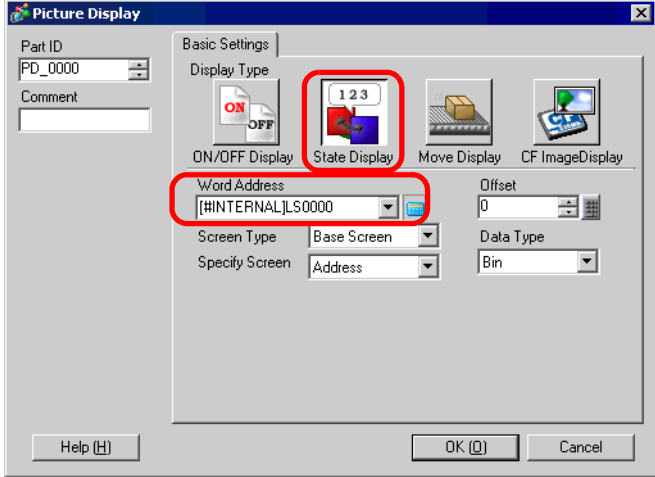
Setting	Description						
<p style="writing-mode: vertical-rl; transform: rotate(180deg);">[Window] - [Change Picture Display]</p> <p>Picture Display Word Address</p>	<p>Set a word address to store the screen No. of the screen displayed in a Picture Display. Set the same address as the [Word Address] of the Picture Display placed on the Window Screen.</p>  <p>NOTE</p> <ul style="list-style-type: none"> • In a Picture Display set to [State Display], set the [Screen Type] to [Base Screen], [Specify Screen] to [Address], and [Data Type] to [Bin]. 						
<p>Window Settings</p>	<p>Configure the Window's settings.</p> <table border="1" data-bbox="200 1006 1266 1690"> <tr> <td data-bbox="200 1006 377 1251"> <p>Local/Global</p> </td> <td data-bbox="377 1006 1266 1251"> <p>Set whether to use a local window or global window for a Sub Display.</p> <p>NOTE</p> <ul style="list-style-type: none"> • To use a global window, refer to “18.6.2 Setup Procedure” (page 18-18) . On the [System Settings Window] - [Main Unit Settings] - [Action Settings] tab, set [Global Window Operation] to [Indirect], and [Data Type] to [Bin]. Use LS16 to display or erase the Window. </td> </tr> <tr> <td data-bbox="200 1251 377 1338"> <p>Window Screen No.</p> </td> <td data-bbox="377 1251 1266 1338"> <p>Designate the Screen No. of the window used for a Sub Display from 1 to 2,000.</p> </td> </tr> <tr> <td data-bbox="200 1338 377 1690"> <p>Window Control Address</p> </td> <td data-bbox="377 1338 1266 1690"> <p>To use a local window for a Sub Display, designate the address used to control the window display. Four consecutive words will automatically be used, starting from the designated address. Set the same address as the [Window Control Address] of the Window Part placed on the same screen as the Text Alarm Part. ☞ “18.7.2 Word Action” (page 18-23)</p> <p>NOTE</p> <ul style="list-style-type: none"> • Set the Window Part's [Window Specification] to [Address], and [Data Type] to [Bin]. </td> </tr> </table>	<p>Local/Global</p>	<p>Set whether to use a local window or global window for a Sub Display.</p> <p>NOTE</p> <ul style="list-style-type: none"> • To use a global window, refer to “18.6.2 Setup Procedure” (page 18-18) . On the [System Settings Window] - [Main Unit Settings] - [Action Settings] tab, set [Global Window Operation] to [Indirect], and [Data Type] to [Bin]. Use LS16 to display or erase the Window. 	<p>Window Screen No.</p>	<p>Designate the Screen No. of the window used for a Sub Display from 1 to 2,000.</p>	<p>Window Control Address</p>	<p>To use a local window for a Sub Display, designate the address used to control the window display. Four consecutive words will automatically be used, starting from the designated address. Set the same address as the [Window Control Address] of the Window Part placed on the same screen as the Text Alarm Part. ☞ “18.7.2 Word Action” (page 18-23)</p> <p>NOTE</p> <ul style="list-style-type: none"> • Set the Window Part's [Window Specification] to [Address], and [Data Type] to [Bin].
<p>Local/Global</p>	<p>Set whether to use a local window or global window for a Sub Display.</p> <p>NOTE</p> <ul style="list-style-type: none"> • To use a global window, refer to “18.6.2 Setup Procedure” (page 18-18) . On the [System Settings Window] - [Main Unit Settings] - [Action Settings] tab, set [Global Window Operation] to [Indirect], and [Data Type] to [Bin]. Use LS16 to display or erase the Window. 						
<p>Window Screen No.</p>	<p>Designate the Screen No. of the window used for a Sub Display from 1 to 2,000.</p>						
<p>Window Control Address</p>	<p>To use a local window for a Sub Display, designate the address used to control the window display. Four consecutive words will automatically be used, starting from the designated address. Set the same address as the [Window Control Address] of the Window Part placed on the same screen as the Text Alarm Part. ☞ “18.7.2 Word Action” (page 18-23)</p> <p>NOTE</p> <ul style="list-style-type: none"> • Set the Window Part's [Window Specification] to [Address], and [Data Type] to [Bin]. 						

Continued

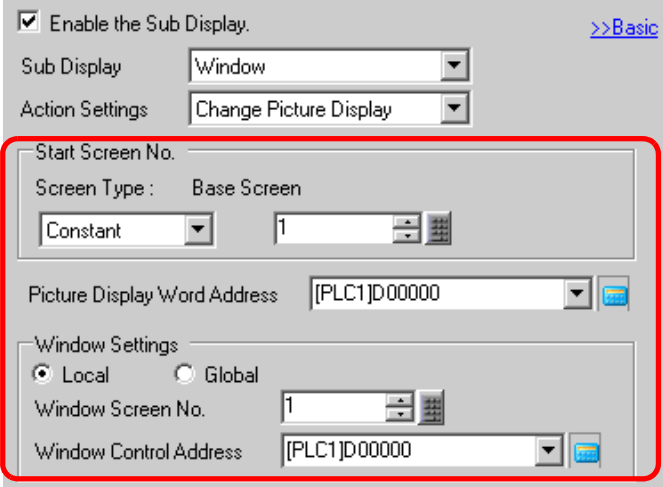
Setting	Description
<p>[Window] - [Text Display Change]</p>	<p>Display a text corresponding to the Alarm Message in the Message Display placed on the Window Screen.</p> 
<p>Start Screen No.</p>	<p>Set the Start No. of the text for a sub screen displayed in a Message Display on the Window Screen. Select the method to designate the text No. from [Constant] or [Address].</p> <ul style="list-style-type: none"> • Constant Designate a set constant as the Text's Start No. The value can be from 1 to 8,999. • Address Select a word address that stores the Text's Start No.

Continued

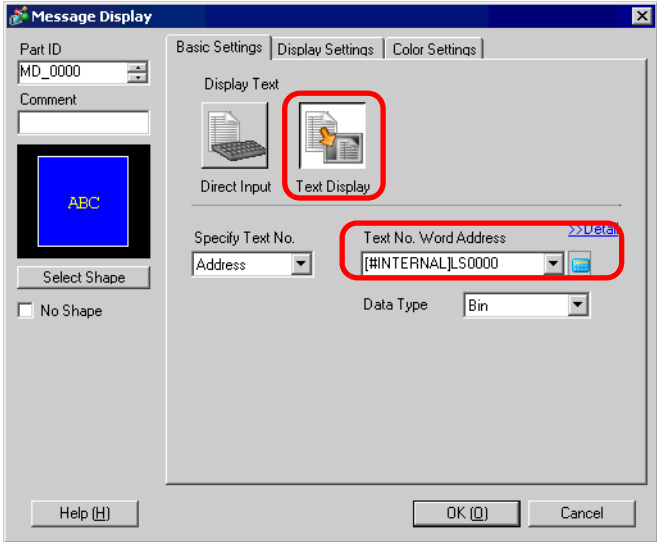
Setting	Description						
<p style="writing-mode: vertical-rl; transform: rotate(180deg);">Text Display Change</p> <p>Text Display Word Address</p>	<p>Set a word address to store the Text No. of the text displayed in a Message Display. Set the same address as the [Text No. Word Address] of the Message Display placed on the Window Screen.</p>  <p>NOTE</p> <ul style="list-style-type: none"> • Set the Message Display [Text Display]’s [Specify Text No.] to [Address], and [Data Type] to [Bin]. 						
<p>Window Settings</p>	<p>Configure the Window’s settings.</p> <table border="1" data-bbox="200 1035 1266 1715"> <tr> <td data-bbox="200 1035 377 1282"> <p>Local/Global</p> </td> <td data-bbox="377 1035 1266 1282"> <p>Set whether to use a local window or global window for a Sub Display.</p> <p>NOTE</p> <ul style="list-style-type: none"> • To use a global window, refer to “18.6.2 Setup Procedure” (page 18-18) . In the [System Settings Window] click [Main Unit Settings]. Then, in the [Action Settings] tab, set [Global Window Operation] to [Indirect] and [Data Type] to [Bin]. Use LS16 to show or hide the Window. </td> </tr> <tr> <td data-bbox="200 1282 377 1367"> <p>Window Screen No.</p> </td> <td data-bbox="377 1282 1266 1367"> <p>Designate the Screen No. of the window used for a Sub Display from 1 to 2,000.</p> </td> </tr> <tr> <td data-bbox="200 1367 377 1715"> <p>Window Control Address</p> </td> <td data-bbox="377 1367 1266 1715"> <p>To use a local window for a Sub Display, designate the address used to control the window display. Four consecutive words will automatically be used, starting from the designated address.</p> <p>Set the same address as the [Window Control Address] of the Window Part placed on the same screen as the Text Alarm Part.</p> <p>☞ “18.7.2 Word Action” (page 18-23)</p> <p>NOTE</p> <ul style="list-style-type: none"> • Set the Window Part’s [Window Specification] to [Address], and [Data Type] to [Bin]. </td> </tr> </table>	<p>Local/Global</p>	<p>Set whether to use a local window or global window for a Sub Display.</p> <p>NOTE</p> <ul style="list-style-type: none"> • To use a global window, refer to “18.6.2 Setup Procedure” (page 18-18) . In the [System Settings Window] click [Main Unit Settings]. Then, in the [Action Settings] tab, set [Global Window Operation] to [Indirect] and [Data Type] to [Bin]. Use LS16 to show or hide the Window. 	<p>Window Screen No.</p>	<p>Designate the Screen No. of the window used for a Sub Display from 1 to 2,000.</p>	<p>Window Control Address</p>	<p>To use a local window for a Sub Display, designate the address used to control the window display. Four consecutive words will automatically be used, starting from the designated address.</p> <p>Set the same address as the [Window Control Address] of the Window Part placed on the same screen as the Text Alarm Part.</p> <p>☞ “18.7.2 Word Action” (page 18-23)</p> <p>NOTE</p> <ul style="list-style-type: none"> • Set the Window Part’s [Window Specification] to [Address], and [Data Type] to [Bin].
<p>Local/Global</p>	<p>Set whether to use a local window or global window for a Sub Display.</p> <p>NOTE</p> <ul style="list-style-type: none"> • To use a global window, refer to “18.6.2 Setup Procedure” (page 18-18) . In the [System Settings Window] click [Main Unit Settings]. Then, in the [Action Settings] tab, set [Global Window Operation] to [Indirect] and [Data Type] to [Bin]. Use LS16 to show or hide the Window. 						
<p>Window Screen No.</p>	<p>Designate the Screen No. of the window used for a Sub Display from 1 to 2,000.</p>						
<p>Window Control Address</p>	<p>To use a local window for a Sub Display, designate the address used to control the window display. Four consecutive words will automatically be used, starting from the designated address.</p> <p>Set the same address as the [Window Control Address] of the Window Part placed on the same screen as the Text Alarm Part.</p> <p>☞ “18.7.2 Word Action” (page 18-23)</p> <p>NOTE</p> <ul style="list-style-type: none"> • Set the Window Part’s [Window Specification] to [Address], and [Data Type] to [Bin]. 						

◆ **Switch Settings**

Select an operation switch to display an Alarm Message. Using a Sub Display requires an operation switch to designate the message to display its sub display.

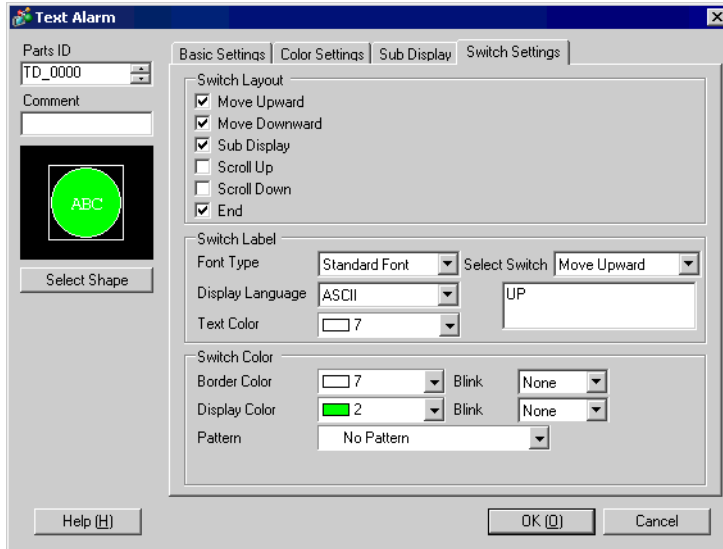

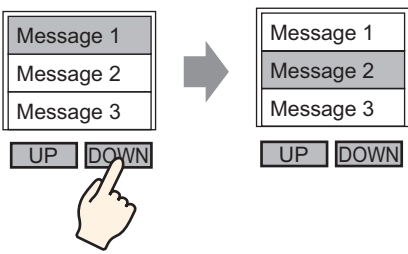
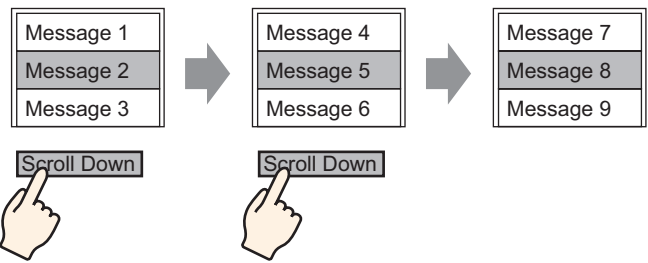
Setting	Description
<p>Switch Layout</p> <p>Move Upward/ Move Downward</p>	<p>Set the Switches to be placed.</p> <p>Moves the cursor 1 row up or down.</p> 
<p>Sub Display</p> <p>Scroll Up/Scroll Down</p>	<p>Shows the Sub Display of the message currently selected with the cursor.</p> <p>Alarm Messages that are currently displayed are scrolled up or down by a given number of rows. e.g.: No. of Active Alarms: 9, No. of Display Lines: 3, No. of Rows to Move: 3</p> 

Continued

Setting		Description
	No. of Rows to Move	Set the number of rows to scroll up and scroll down from 1 to 512.
	End	Set a switch to end the Text Alarm. Touching the switch erases the cursor as well as the Sub Display.
Switch Label		Set the Switch's label.
	Font Type	Choose a font type for the switch's label from [Standard Font] or [Stroke Font].
	Display Language	Select a language for the Switch Label from [Japanese], [Western], [Chinese (Traditional)], [Chinese (Simplified)], [Korean], [Cyrillic], or [Thai].
	Text Color	Select a color for the switch's label.
	Select Switch	Select the switch to which the label is set.
	Label	Input the text of the label.
Switch Color		Set the switches' color. <div style="border: 1px solid black; padding: 2px; display: inline-block;">NOTE</div> <ul style="list-style-type: none"> The Switch Color setting is common to all Text Alarm parts, regardless of the switch type selected.
	Border Color	Select a border color for the Switch.
	Display Color	Set the switches' color.
	Pattern	Select the switches' pattern from 9 types.
	Pattern Color	Specify the pattern color when you select options other than [No Pattern].
	Blink	Select whether or not the Switch will blink, and the blink speed. You can choose different blink settings for the [Border Color], [Display Color], and [Pattern Color]. <div style="border: 1px solid black; padding: 2px; display: inline-block;">NOTE</div> <ul style="list-style-type: none"> There are cases where you can and cannot set Blink depending on the Main Unit and System Settings' [Color Settings]. ☞ "9.5.1 Setting Colors ■ List of Available Colors" (page 9-34)

-
- NOTE**
- If you want to change the shape and color of each switch, create a switch with a Switch Lamp Part's Special Switch (Text Alarm Switch).
☞ "11.14.4 Special Switch ■ Switch Feature ◆ Text Alarm Switch" (page 11-64)
 - If [Scroll Feature] is not set on the [Basic Settings] tab, the messages are not scrolled even when the [Move Upward], [Move Downward], [Scroll Up], or [Scroll Down] switch is touched. The cursor moves only within the display area.
-

19.10 Restrictions

19.10.1 Restrictions for Printing Alarm History

◆ [Real Time Print]

- In the Real Time Print, block names such as “Message”, “Date”, and “Trigger” are not printed.
- The GP unit can store printing information for a maximum of 1,000 Alarm Messages (Banner) and Alarm Histories. If no printer is connected to the GP, it can still store up to 1000 messages, but any messages over 1000 will be lost while the GP is waiting to print.
- If the printer goes offline during printing due to a paper jam, etc., fix the printer error without turning off the GP’s power. Print information stored in the GP will be sent to the printer when it comes back online.
- If the printer’s power goes off during printing, the data sent from the GP during that time will not be printed.

◆ For [Batch Print]

- Alarms that are triggered or recover during printing will not be printed. Alarm information which exists when printing starts will be printed.
- If the GP unit turns OFF during printing, printing will not continue when power is turned back ON. If the trigger bit is ON when power is turned back ON, printing will start from the beginning.
- When turning the print trigger bit from ON to OFF or from OFF to ON, be sure to allow at least one communication cycle^{*1} or one Display Scan Time^{*2} period, whichever is longer.
- If the number of stored alarms is set to “0” on the [Alarm Settings] - [Common Settings] tab, or if no alarms have yet been triggered, “No. of Messages = 0” will be printed.
- If the number of stored alarms is set to “0” on the [Alarm Settings] - [Common Settings] tab, the [Completion Bit] will not turn ON.
- Only the first 2 lines of block names, such as [Messages], [Date], [Trigger], etc. will be printed. However, even if the line extends over several pages, block names will only be printed on the first page.
- When the alarm message language is set to Japanese, item names such as “Message”, “Date”, or “Trigger” are output in Japanese. When using any other language (Western, For For Korean, Chinese (Traditional), Chinese (Simplified), Cyrillic or Thai, the item names are output in English.

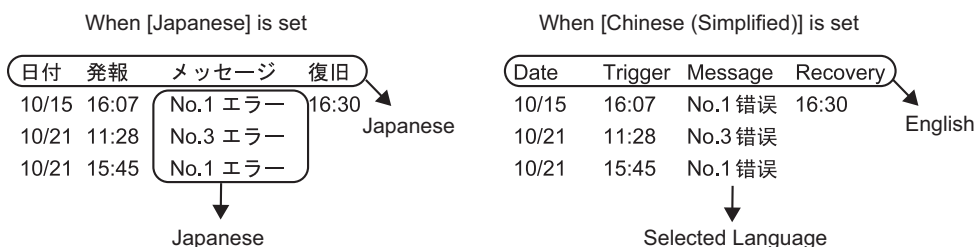

*1 The communication cycle time is the time it takes to request and take in data from the GP unit to the PLC. It is stored in the internal device’s LS2037 as binary data. The unit is 10 ms.

*2 Display Scan Time is the time it takes to display/calculate 1 screen. It is stored in the internal device’s LS2036 as binary data. The unit is milliseconds (ms).

19.10.2 Restrictions for Sub Display Settings/Detail

- The Message Display [Text Display] and Picture Display [State Display]'s word addresses as well as Window Part's window control addresses used for a Sub Display are set only in the address of the internal device (LS area, user area).
- The cursor movement and sub display are not linked. Even when the cursor moves, the sub display remains the same.
- Sub displays will not be cleared automatically. Even when an Alarm Message in the sub screen is cleared, the sub display still remains. When, however, the screen is changed, "0" is written to the word address of the Picture Display [State Display] and Message Display [Text Display], and window control address used for the sub display, and the sub display is cleared.
- When displaying a sub screen, only one Alarm Part (History Display) can be set on each base screen. If multiple Alarm Parts (History Display) are set, a sub display is disabled.
- When [Direct Selection] is set, buttons may be hard to touch depending on the calibration of the touch panel^{*1} and the message line spacing.
- When [Play Movie] is selected as the Sub Display, the [Sub Display Screen No.] specified in the [Alarm Settings] acts as the index number of the Movie File played on the [Movie Player]. Define a value from 0 to 99.

Assigning "0" to the Sub Display Screen number means you specified Movie File index number "0". For alarms that don't need a Sub Display, assign "9999" to the Sub Display Screen number.

If you assign the index number of a Movie File that does not exist, then the player will stop.

- Bit 8 (Play Bit) of the specified [Play Control Word Address] is used to control play operations. To stop playing the movie, create a switch to turn the Play Bit OFF instead of using a typical stop operation.
- When the Video Display bit is ON, the Video Display takes precedence over the Alarm Sub Display. The Alarm Sub Display is hidden but continues operating. As a result, when the Video Display is turned OFF, the Alarm Sub Display video continues playing from the elapsed point in time.

*1 The adjustment of the touch panel's touch area and display so that their settings synchronize. This can be set in the GP unit.

19.10.3 Restrictions for Performing External Operation from Multiple GPs

External operations can be performed by multiple GP units at the same time. However, a time lag will occur due to each GP's read time, and the order in which the operations are performed and the [Completion Bit] turns ON will differ. Set the operation code after verifying that every [Completion Bit] in each GP has turned OFF.

Also, when clearing the operation code to "0", ensure that every [Completion Bit] in every GP has turned ON.

e.g.:

Set the external operation's [Control Word Address] for several GP units (GP1, GP2) to the same address, and set the [Completion Bit] to separate addresses.

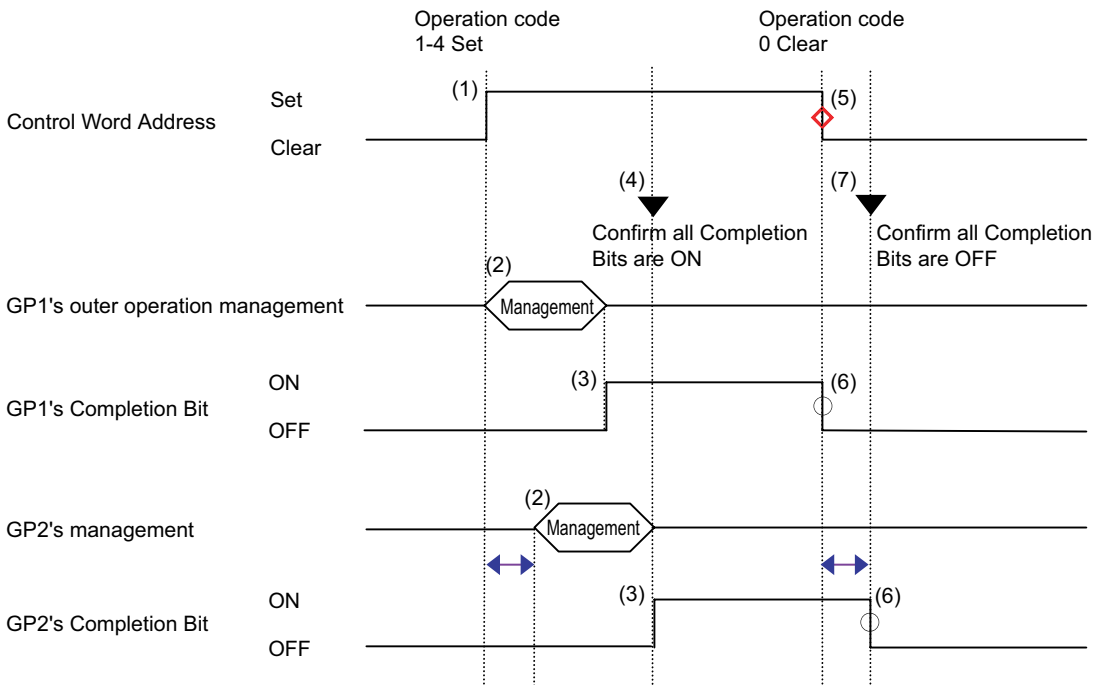
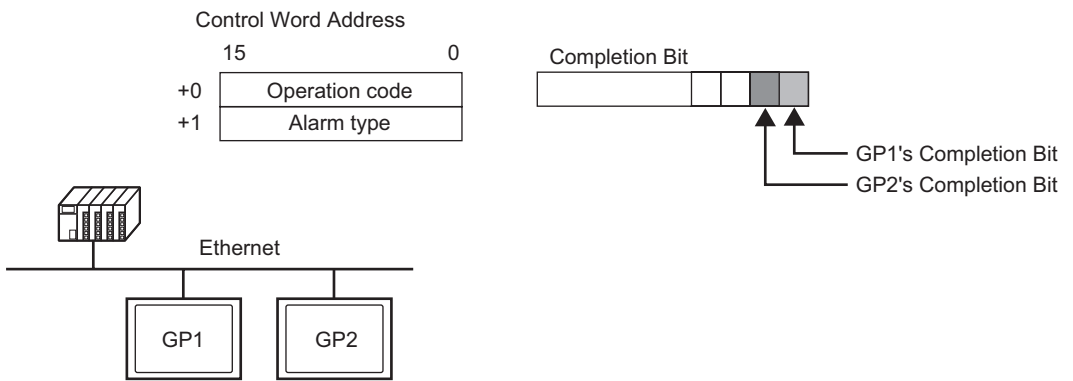

↔ = Communication time lag ○ = GP is OFF ◇ = Please clear data

- (1) Set the operation code and alarm type in the [Control Word Address] from the PLC.
- (2) GP1 and GP2 process orders from the PLC.
- (3) When the operations finish, GP1's and GP2's [Completion Bit] turns ON.
- (4) The PLC verifies that each [Completion Bit] in all the GP units is now turned ON.
- (5) Run the [Control Word Address]'s [Operation Code] "0" (no operation) from the PLC.
- (6) When the GP writes "0" as the [Operation Code], the [Completion Bit] turns OFF.
- (7) The PLC verifies that each [Completion Bit] in all the GP units is now turned OFF.

NOTE

- In case the power gets turned OFF during the process, set the [Control Word Address] to 0 clear and turn OFF all [Complete Bit].
 - While running operations on multiple GP units from the PLC, alarms that are triggered or recovered may not be the same on each GP unit.
 - In [Alarm Settings] - [Common Settings], when [Print Settings] is set to [Real Time Print], if you run an external operation to acknowledge all within a block, the acknowledge order will be [History]→[Log]→[Active]. If the same message is registered in both [History] and [Log], the History acknowledge time and Log acknowledge time will both be printed in real time, so the same acknowledgement message will be printed twice.
-

19.10.4 Text Alarm Restrictions on Parts

- Only one Text Alarm can be set to a single Base Screen. To display two or more Text Alarm Parts on one screen, use a Window Screen in which Text Alarm Parts are placed.
- The maximum number of display characters on one row is decided by the GP model and the text size.
- If the Alarm Message is wider than the display area, the portion that exceeds the area is truncated and is not displayed.
- When the Text No. of the text displayed in the Text Alarm Part is changed during operation, the cursor and sub display being displayed are cleared.
- When too many alarms arise simultaneously, you can place Text Alarm Parts on multiple screens and designate [Display Start Row] as follows to view the messages by changing screens.
 - 1st screen: Start row (normally “1”)
 - 2nd screen: No. of display lines on one screen + Start row
 - nth screen: No. of display lines on one screen \times (n-1) + Start row
- The Base Screen No. or Text No. used for a sub display should be created in sequential numbers in the same order as the text rows to which Alarm Messages are registered.
- The Base Screen and Text used for a Sub Display use screens equal to “(16 \times No. of Monitoring Words) + 1”. These screens cannot be used for other purposes.
- When the cursor is cleared during a sub display (the cursor is moved to the place outside of the display area, or the “End” switch is touched), the sub display is also be cleared.
- The value of “the designated [Start Screen No.] + (No. of Monitoring Words \times 16)” is used as the Clear Base Screen No. or Clear Text No. to clear the sub display.
For example, when the Start Screen No. is “100” and the No. of Monitoring Words is “1”, Screen Nos. 100 to 115 are used for the sub display screen and Screen No. 116 is used for the clearing screen.
- When a sub screen is displayed with a Message Display [Text Display] and no clearing text is provided, the sub screen is cleared with [Clear Color] designated for the Message Display.
- When a screen with a sub screen is changed, the sub screen is cleared. The GP writes “0” to the designated word addresses of the Picture Display [State Display], Message Display [Text Display], and Window Part used for a Sub Display.
- When [Start Screen No.] of the sub display is designated with [Address], do not change the Start Screen No. while the sub screen is displayed. This may interfere with proper sub display.
- While a Sub Screen is displayed, communication time may increase.

19.11 Alarm Feature List

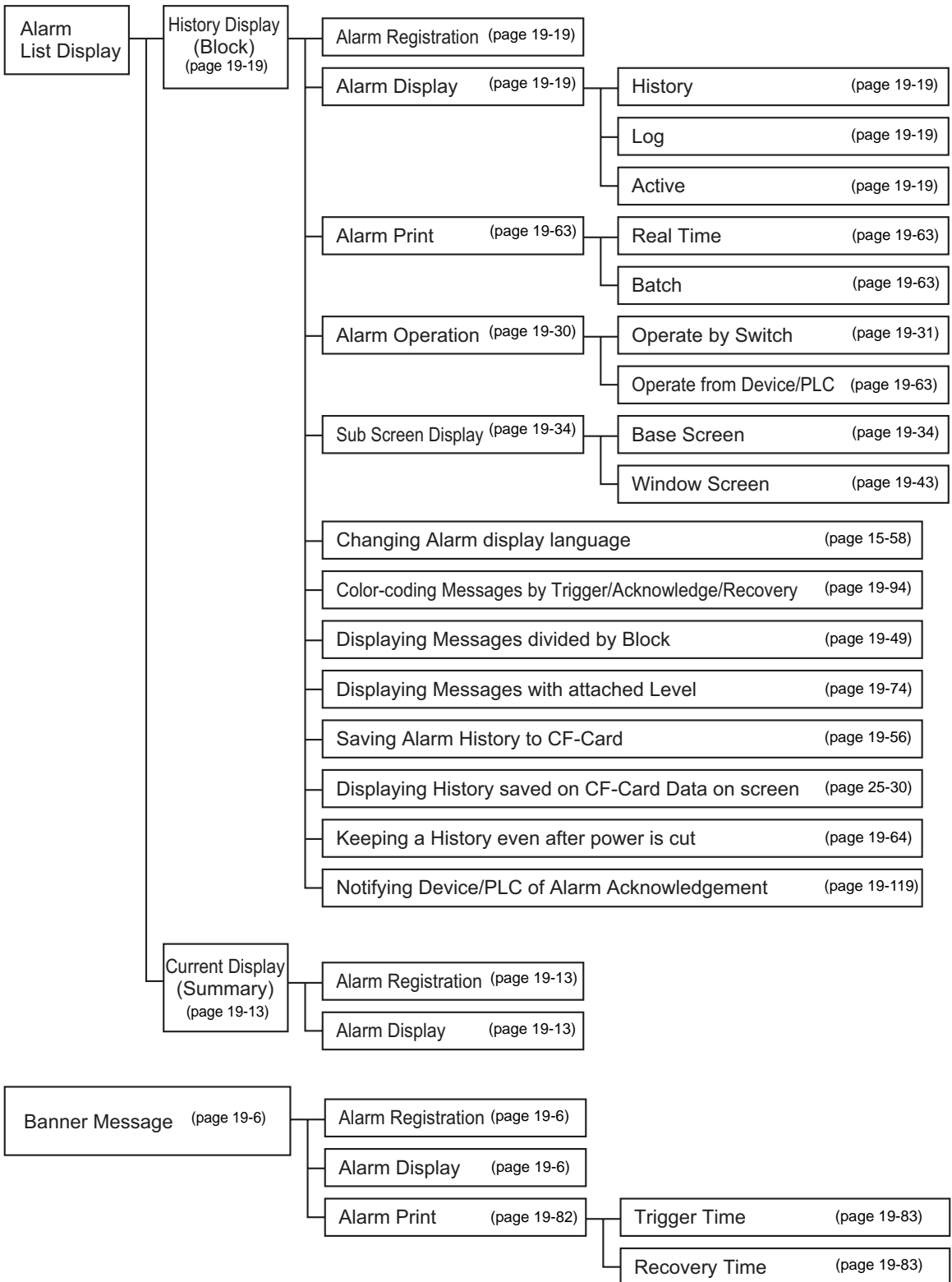

Memo