



# Preface

Thank you for purchasing Digital's TFT type color display panel, the 'FP-3710T series' (hereafter referred to as the FP unit).

Please read this manual completely to insure the correct use and complete understanding of the FP unit's functions.

## NOTICE

1. Copying this manual's contents, either in whole or in part, is prohibited without the express permission of Digital Electronics Corporation, Japan.
2. The information contained in this manual is subject to change without notice.
3. If you find any errors or omissions in this document, please contact Digital Electronics Corporation to report your findings.
4. Please be aware that Digital Electronics Corporation shall not be held liable by the user for any damages, losses, or third party claims arising from the uses of this product.

Product names used in this manual are the trademarks / registered trademarks of their respective owners.





© 2006 Digital Electronics Corporation. All rights reserved.

# Essential Safety Precautions

This manual describes safety instructions for correct use of the FP unit. Please keep this manual close at hand and refer to it when necessary.

## Safety Icons







Throughout this manual, these icons provide essential safety information for FP operation procedures requiring special attention. These icons indicate the following levels of danger:

 <b>WARNING</b>	Indicates situations where severe bodily injury, death or major equipment damage can occur.
 <b>CAUTION</b>	Indicates situations where slight bodily injury or minor equipment damage can occur.
	Indicates actions or procedures that should NOT be performed.
	Indicates actions or procedures that MUST be performed to ensure correct unit operation.

---

## WARNING

---

-  Because of the ever present danger of electrical shock, be sure to unplug the power cable from the FP unit before plugging the cable's other end into the wall.
-  Do not use power in excess of the unit's specified voltage range since it may cause a fire or electric shock.
-  Because the FP unit contains high voltage parts, an electric shock can occur when disassembling the unit. Therefore, be sure to always unplug the unit before disassembling it.
-  Do not modify the FP unit in any way, since it may cause a fire or electric shock.
-  Do not use touch panel keys to perform life-threatening or vitally important safety functions. Use separate mechanical switches for such keys.
-  Do not use the FP unit as a warning device for critical alarms that can cause serious operator injury, machine damage or production stoppage. Critical alarm indicators and their control/activator units must be designed using stand-alone hardware and/or mechanical interlocks.

- ⊘ In a situation that a detection function for the backlight burnout has been ineffective, if a burnout of the backlight happened, unlike in an extinction condition of the backlight of FP, the touch panel is still active. If an operator fails to notice that the backlight is burned out and touches the panel, a potentially dangerous machine miss-operation can occur. Therefore, do not set up switches on the touch panel of an FP that are likely to cause human error or physical damage triggered by mis-operation.

If your FP's backlight suddenly turns OFF, use the following steps to determine if the backlight is actually burned out.

1) If your current FP application or Auto off Disp function is not set, and the screen has gone blank, your backlight is burned out.

2) If your current FP application or Auto off Disp function is set, and if touching the screen does not cause the display to reappear, your backlight has been burned out.

- ⚠ If substantial amounts of metallic dust, water or liquids enter the FP unit, turn off the power supply immediately, unplug the power cord, and contact your local FP distributor.
- ⚠ When installing the FP unit, be sure to follow the instructions given in "Chapter 3 Installation and Wiring," to insure it is done correctly.
- ⊘ Do not use the FP in an environment with flammable gas, since it may cause an explosion.
- ⊘ The FP is not appropriate for use with aircraft control devices, aerospace equipment, central trunk data transmission (communication) devices, nuclear power control devices, or medical life support equipment, due to these devices' inherent requirements of extremely high levels of safety and reliability.
- ⚠ When using the FP with transportation vehicles (trains, cars and ships), disaster and crime prevention devices, various types of safety equipment, non-life support related medical devices, etc, redundant and/or failsafe system designs should be used to ensure the proper degree of reliability and safety.

---

 CAUTION

---

- ⊘ Do not press the screen's touch surface too strongly with either your finger or a hard object, since the touch surface may be damaged.
- ⚠ When the surface of the display screen becomes dirty or smudged, clean the display with a cloth soaked in a neutral detergent. Do not use paint thinner or organic solvent.
- ⊘ Do not press on the touch panel's face with sharp objects, such as a mechanical pencil or screwdriver, since it might damage the LCD panel.
- ⊘ Avoid using or storing the FP in direct sunlight, excessively dusty or dirty environments, or where chemicals or their vapors are present in the air.

- ⊘ Avoid restricting the FP's natural ventilation, or storing and using the FP in an environment that will increase the FP's internal temperature.
- ⊘ Do not use the FP in areas where sudden, large changes in temperature may occur. These changes can cause condensation to form inside the unit, possibly causing an accident.
- ⊘ Do not store or use the FP where chemicals (such as organic solvents, etc.) and acids can evaporate, or where chemicals and acids are present in the air.
- ⊘ When the product is disposed of, it should be done so according to your country's regulations for similar types of industrial waste.

## LCD Panel Usage Precautions

### Notes on the FP's Liquid Crystal Display (LCD)

For detailed LCD information, please contact Digital's Development department, Product Quality Assurance group.

- The FP's LCD contains a strong irritant. If the panel is damaged and the LCD unit's liquid contacts your skin, be sure to wash it with running water for at least 15 minutes. If any of this liquid should enter your eye, be sure to flush the eye with running water for more than 15 minutes, and see a doctor immediately.
- The FP unit's LCD screen may flicker or show unevenness in the brightness of certain images or at some contrast settings. This is an LCD characteristics and not a product defect.
- There's an individual difference in brightness and tone of LCD screen. Please be aware of this difference before using the lined-up plural units.
- There are minute grid-points on the LCD surface. These points are not defects.
- The displayed color will look different when viewed from an angle outside the specified view angle. This is also normal.
- Displaying a single screen image for long periods of time can cause an afterimage to remain. To correct this, turn the unit OFF for 5 or 10 minutes, then turn it ON again. This phenomenon is a common attribute of the LCD unit's, and not a defect. To prevent this effect, you can:
  - use the Display OFF feature, if the same image is to be displayed for a long period of time.
  - change the screen display periodically to prevent the displaying of a single image for a long period of time.

## Connecting the FP to a PC

The FP-3710T Series units are designed as a standard XGA display.

Be aware that some types of XGA equipment may not be within the ranges specified in this document, and, therefore, cannot be connected to the FP.

Also, if you change your PC's XGA board, there is the possibility that the new board may not be able to be connected to the FP.

**SEE →**

*2.3 Interface Specifications (page2-5)*

**IMPORTANT**

- When a signal timing value not compatible with this device is entered, or if the entered timing is larger than can be displayed by the dot clock, an "Out of range" message is displayed. If this occurs, be sure to read your computer's manual and enter a value that is compatible with this device.
- If no signal (synchronized signal) is entered, a "No signal" message is displayed.

## Information Symbols

This manual uses the following icons:

<b>IMPORTANT</b>	Indicates a warning or a product limitation. Be sure to follow the instructions given with this icon to ensure the safe operation of the FP.
<b>NOTE</b>	Contains additional or useful information.
(1) (2)	Indicates steps used to accomplish a given task. Be sure to follow these steps in the order they are written.
*1	Indicates useful or important supplemental information.
<b>SEE →</b>	Indicates pages containing related information.
FP Series	Indicates a generic name for the products of FP3710-T41-U and FP3710-T41.

## FP-3710T Series Models

The FP-3710T Series refers to the following FP model numbers:

Series	Product Name	Model Type	Power input type	Standards
FP-3710T Series	FP-3710T (with front USB)	FP3710-T41-U	AC	UL/c-UL/CSA Approved, CE Marked
	FP-3710T (no front USB)	FP3710-T41		

## FP-3710T Series Package Contents

The FP unit's packing box contains the items listed below. Please check to be sure each item is included and is not damaged.

### FP Unit (1)

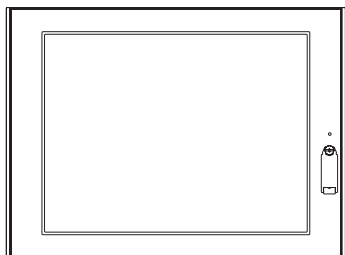

(This model is FP3710-T41-U)

### Installation Guide (1)(English / Japanese)

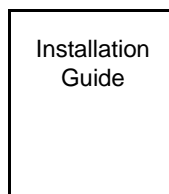

### Installation Gasket (attached to the FP unit) (1)



### Installation Fasteners (8: 4x2 set)

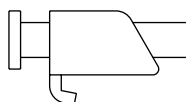

### AC Power Cable (1)

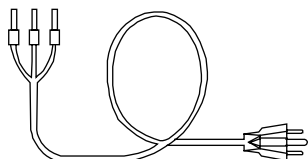

### AC Power Connector (attached to the FP unit) (1)

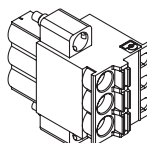

### USB Cable Clamp (1)

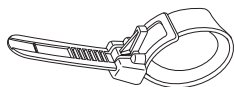

### Warning Caution Information (1)

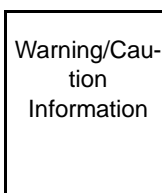

- IMPORTANT**
- The power cord for FP is designed only for AC100V or AC115V use. Under other voltage situation, you should use a different cord in conformity with the voltage.
  - Note that the Power cord is not an appliance complying with the Electrical Appliance and Material Safety Law.
  - The AC Power cord can only be used for the FP units. Note that the specification of the cord doesn't guarantee to fit any other electrical appliances.

This unit has been carefully packed, with special attention to quality. However, should you find anything damaged or missing, please contact your local FP distributor immediately.



## Main Features

The FP-3710T series displays are equipped with the following features.

- High Quality TFT Color LCD Display

This unit is equipped with a 15.0 inch TFT type color LCD. Its superior brightness and wide viewing angle, not found in ordinary laptop-type TFT LCDs, widens your scope of applications.

The screen's maximum resolution is  $1024 \times 768$  pixels and can display 1,677 colors.

- Easy Installation In User's Cabinets and Panels

The FP's slim and compact design makes installation a snap since it was designed specifically for use as an IA (Industrial Automation) or OA (Office Automation) system monitor. The flat, front panel provides protection equivalent to the rigorous IP65f standard. Even without its optional protective cover the front panel is highly resistant to both water and dust.

- Panel can be used as a VGA Display

Since the FP is equipped with an analog RGB interface and a DVI-D Interface, it can be connected to a PC and other, similar devices. (The PC's dot clock frequency, however, must be within the standard range.)

- Easy-to-use Built-In Touch Panel

The FP's built-in touch panel is standard equipment, allowing touch panel data to be output to a host PC via an RS-232C cable or USB cable. This is perfect for systems requiring both touch panel operation and data monitoring.

- USB-HUB function (Model Type: FP3710-T41-U)

The FP-3710T unit has USB-HUB function and can connect USB devices to the front USB connector.

## What is IP65f?

This unit's protection rating of IP65f is actually a composite code, consisting of the internationally recognized British "Ingress Protection" standard (BS EN 60529:1992) - "IP65", and the standard developed by the Japanese Electronics Manufacturer's Association (JEM) - "F". This code is used in this manual to identify a given product's degree of structural resistance to a variety of environmental elements and thus, prevent problems or accidents related to the inappropriate use of a product. The individual meaning of each character of this code is explained below.

I P 6 5 f  
(1) (2) (3) (4)

(1)	Designates the type of protection provided.
(2)	Indicates the degree of protection provided to the human body by the unit, and the degree of protection provided by the unit's front face from particles/dust intrusion into the interior of the unit. Here, "6" indicates that the unit is completely protected from dust intrusion.
(3)	Indicates the degree of protection provided by the unit's front face from water intrusion into the interior of the unit. Here, "5" indicates that the unit is protected from water intrusion from a direct water jet.
(4)	Indicates the degree of protection provided by the unit's front face from oil particle intrusion into the interior of the unit. Here, "f" indicates that the unit is completely protected from oil intrusion via either oil particles or oil splashes from any direction (to the front panel).

## Required Software /Reference Manual

An FP-3710T series unit needs the following software for operation. As the FP user manual, provided by PDF media, describes its details, download the manual below and get the further information. Visit our support site below and get both software and reference manual.

Digital Electronics Corporation's support site - Otasuke Pro!

<http://www.pro-face.com/otasuke/>

- Software: Mouse Emulation Software
- Manual: FP-3710T series User Manual

# UL/c-UL/CSA Approval

FP-3710T Series is a UL/c-UL/CSA listed product. (UL File No.E220851, CSA File No. 219866)

Those products conform to the following standards:

- UL508 Industrial Control Equipment
- CSA-C22.2, No.142-M1987 Process Control Equipment.

Product Model No.	UL Registration Model No.
FP3710-T41-U	3580406-01
FP3710-T41	

## <Cautions>

- The FP must be used as a built-in component of an end-use product.
- This unit should be installed in the front face of a metal panel.
- If this unit is installed so as to cool itself naturally, be sure to install it in a vertical panel.

Also, be sure that the FP unit is mounted at least 100 mm away from any adjacent structures or equipment. If these requirements are not met, the heat generated by the FP unit's internal components may cause the unit to fail to meet UL/c-UL standard requirements.

- For use in Pollution Degree 2 environment
- For use on a flat surface of a Type 1 Enclosure.

## **CE Marking**

The FP-3710T Series is a CE marked product that conforms to EMC directives and Low Voltage directives EN55011 Class A, EN61000-6-2 and EN60950-1 First Edition.

\*For detailed CE marking information, contact your local FP distributor.



# Table of Contents

Preface .....	1
Essential Safety Precautions .....	2
Connecting the FP to a PC .....	5
Information Symbols .....	6
FP-3710T Series Models .....	6
FP-3710T Series Package Contents .....	7
Main Features .....	8
What is IP65f? .....	9
Required Software /Reference Manual .....	9
UL/c-UL/CSA Approval .....	10
CE Marking .....	11
Table of Contents .....	13
Chapter 1 Introduction	
1.1 System Design .....	1-2
1.2 Optional Equipment .....	1-3
Chapter 2 Specifications	
2.1 General Specifications .....	2-2
2.1.1 Electrical specifications .....	2-2
2.1.2 Environmental specifications .....	2-2
2.1.3 Structural specifications .....	2-3
2.2 Functional Specifications .....	2-4
2.2.1 Performance .....	2-4
2.2.2 Display .....	2-4
2.3 Interface Specifications .....	2-5
2.3.1 Analog RGB Interface .....	2-5
2.3.2 DVI-D Interface .....	2-7
2.3.3 Serial Interface .....	2-9
2.3.4 USB Interface (Up-stream port) .....	2-10
2.3.5 Front USB Interface (Down-stream port)(FP3710-T41-U model only) .....	2-10
2.4 Cable Diagrams .....	2-11
2.4.1 RGB Interface Cable Pin Connections (Option cable: VGA standard) .....	2-11
2.4.2 DVI-D Interface Cable Pin Connections (Option cable) .....	2-12
2.4.3 SIO Interface Cable Pin Connections .....	2-13
2.4.4 USB Interface Cable Pin Connections .....	2-13
2.5 Names and Functions .....	2-14
2.6 Dimensions .....	2-15
2.6.1 External Dimensions .....	2-15

2.6.2 Dimensions with installation fasteners .....	2-15
2.6.3 Dimensions with Cables.....	2-16
2.6.4 Installation Fasteners.....	2-16
2.6.5 Panel Cut Dimensions .....	2-17

## Chapter 3 Installation and Wiring

3.1 Installation.....	3-2
3.1.1 Installation Procedures .....	3-2
3.2 Wiring.....	3-7
3.2.1 Connecting the Power Cord.....	3-7
3.2.2 The USB Cable Clamp.....	3-9
3.2.3 Connecting the Power Supply.....	3-10
3.2.4 Precautions: Grounding .....	3-11
3.2.5 Precautions: Input/Output Signal Lines.....	3-11

## Chapter 4 Setting up and Adjusting the FP unit

4.1 Operation Mode Setup.....	4-2
4.1.1 Preset Settings and Adjustments for Dip Switch and Slide Switch .....	4-2
4.1.2 Status of Front LED in Operation Modes .....	4-3
4.2 Screen Display Adjustment.....	4-4
4.2.1 Calibration of OSD Display Position .....	4-4
4.2.2 OSD Setting Icons .....	4-6
4.2.3 OSD Setting Item Details .....	4-7

## Chapter 5 Touch Panel Data

5.1 Touch Interface Data.....	5-2
-------------------------------	-----

## Chapter 6 Troubleshooting

6.1 Troubleshooting .....	6-2
6.1.1 Possible Device Problems .....	6-2
6.1.2 No Display.....	6-3
6.1.3 Touch Panel Does Not Respond.....	6-5
6.2 Error Message .....	6-6
6.2.1 Error Message List.....	6-6

## Chapter 7 Maintenance

7.1 Regular Cleaning.....	7-2
7.1.1 Cleaning the Display .....	7-2

7.1.2 Installation Gasket Replacement .....	7-3
7.2 Periodic Check Points.....	7-4
7.3 Backlight Replacement .....	7-5
7.3.1 Replacing CA3-BLU15-01 .....	7-6



# MEMO

# 1 Introduction

1. System Design
2. Optional Equipment

This chapter describes the outline of FP Series.

## 1.1 System Design

The FP can be connected to Pro-face's PS-2000B or to a Windows<sup>®</sup> compatible PC.

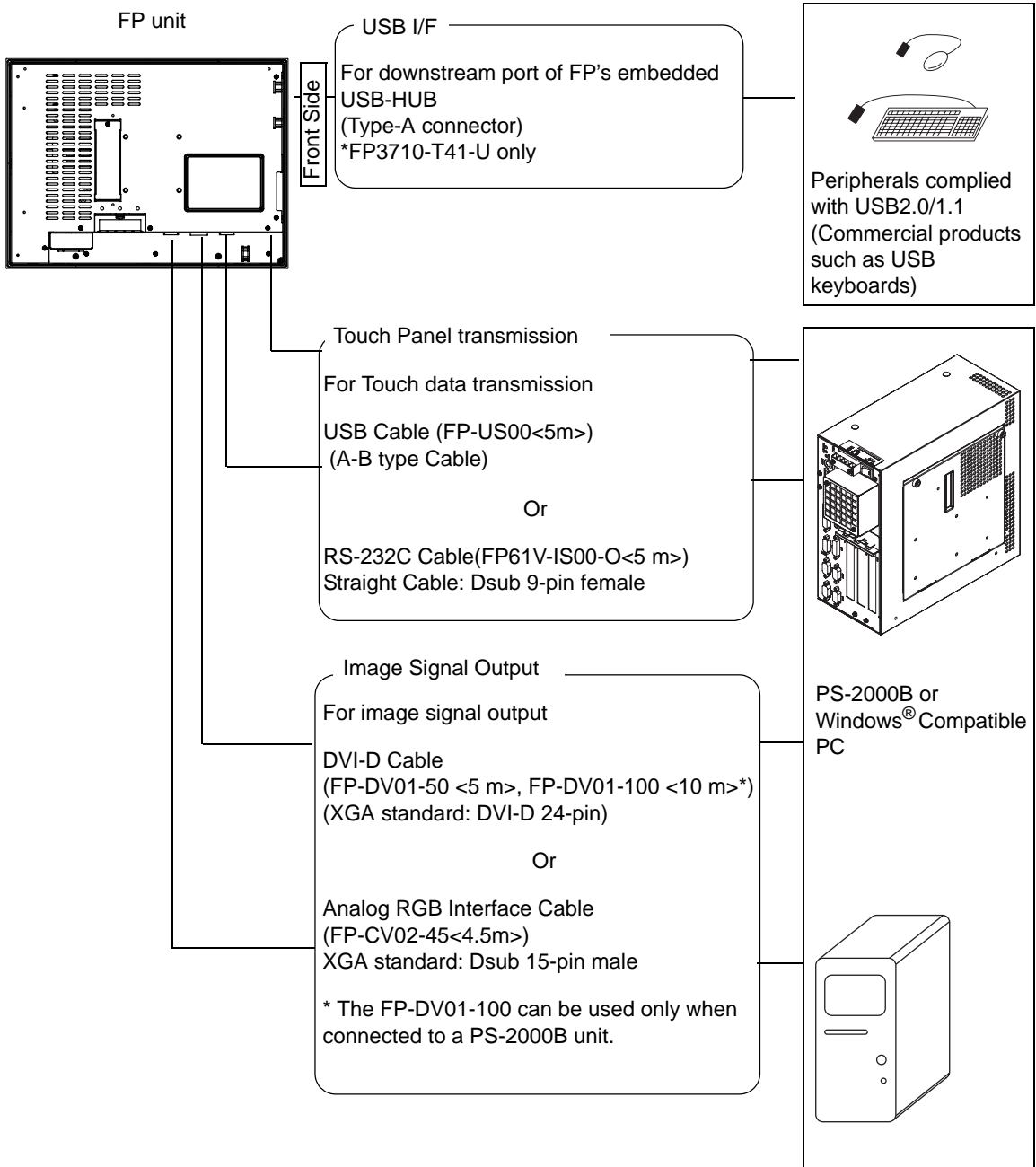

**NOTE**

- The FP unit's slide switch set the type of cable(s) used for sending touch data (USB or RS232C).

**SEE →**

4.1.1 Preset Settings and Adjustments for Dip Switch and Slide Switch (page4-2)

## 1.2 Optional Equipment

All optional items listed below are products of Digital Electronics Corporation.

### ■ Options

Product Name	Model No.	Description
15-inch Unit Cover	CA4-CVR15-01	Attaches to the side face and the top face of the FP unit.

### ■ Cables

Product Name	Model No.	Description
RS-232C Cable	FP61V-IS00-O	Serial interface cable (5m) used for touch panel data transmission between the host and the FP. This is a straight Dsub9 pin female cable.
USB Cable	FP-US00	USB interface cable (5m) used for touch panel data transmission between the host and the FP. The cable type is A-B.
Analog RGB Cable	FP-CV02-45	Analog RGB interface cable (4.5m) when image signal is output to the FP from the host. VGA specifications (Dsub15 pin male). (4.5m)
DVI-D Cable	FP-DV01-50 FP-DV01-100*1	Digital Visual Interface cable used to send the image signal from the host to the FP. XGA specifications (DVI-D 24-pin male). (5 m or 10 m)

\*1 The FP-DV01-100 can be used only when connected to a PS-2000B unit. When using the FP-DV01-100, be sure to turn the PS-2000B's internal dipswitch 4 ON.  
(When using the FP-DV01-50, turn this switch OFF.)

### ■ Maintenance Parts

Product Name	Model No.	Description
Installation Fasteners	CA3-ATFALL-01	Metal installation fasteners.
Rubber Gasket	CA3-WPG15-01	Replacement rubber gasket, used when installing the FP. Same as the FP's original gasket.
Screen Protection Sheet	CA3-DFS15-01	Disposable and dirt resistant sheet for the FP's screen. The FP's touch panel can be used with this cover sheet attached. (5 sheets/set)
Backlight	CA3-BLU15-01	Replacement backlight for the FP. (2/set)

**■ Related Software**

Product Name	Model No.	Description
Mouse Emulator*1	UPDD	Mouse Emulator software for the FP

\*1 OS can be Windows NT®4.0 SP6A or higher, Windows®2000 or Windows®XP.

- IMPORTANT** • Visit our support site below and download the mouse emulation software (UPDD).  
Digital Electronics Corporation's support site - Otasuke Pro!  
<http://www.pro-face.com/otasuke/>

# 2 | Specifications

1. General Specifications
2. Functional Specifications
3. Interface Specifications
4. Cable Diagrams
5. Names and Functions
6. Dimensions

This chapter describes the general, functional and interface specifications of the FP as well as its part names and dimensions.

## 2.1 General Specifications

### 2.1.1 Electrical specifications

Items		Specifications
Power Supply	Rated Voltage	AC100 ~ 240V
	Allowable Voltage	AC85 ~ 264V
	Rated Frequency	50 / 60Hz
	Rated Frequency Range	40Hz ~ 72 Hz
	Allowable Voltage Drop	1 cycle or less (Voltage drop interval must be 1s or more)
	Current Consumption	AC 100V 1.1A or less (TYP 0.75A) AC 240V 0.7A or less (TYP 0.44A)
	In-Rush Current	60A or less
Voltage Endurance		AC1500V 20mA for 1 minute (between charging and FG terminals)
Insulation Resistance		DC500V 10M $\Omega$ or more (between charging and FG terminals)

### 2.1.2 Environmental specifications

Items		Specifications
Physical	Surrounding Air Temperature	0°C ~ 50°C (The panel face should not incline more than 30 °C)
	Storage Temperature	-20°C ~ +60°C
	Ambient Operating Humidity	10%RH (Relative Humidity)~ 90%RH (Wet bulb temperature: 39°C or less - no condensation.)
	Ambient storage Humidity	
	Air Purity (Dust)	0.1 mg/m <sup>3</sup> or less (No electrically conductive dust is allowed)
	Pollution Degree	For use in Pollution Degree 2 environment
	Corrosive gas	Free of corrosive gas
	Atmospherical pressure Resistance	800hPa ~ 1114hPa (Under above sea level 2000m)
Mechanical	Vibration Resistance	JIS B 3502, IEC61131-2 compliant 5Hz ~ 9Hz Half amplitude 3.5mm 9Hz ~150Hz Constant acceleration 9.8m/s <sup>2</sup> X, Y, Z each direction 10 cycles (100 minutes)
	Impact Resistance	JIS B 3501, IEC61131-2 compliant (147 m/s <sup>2</sup> X, Y, Z each direction 3 times)
Electrical	Noise Immunity (via noise simulator)	Noise Voltage: 1,500Vp-p Pulse Duration: 1 $\mu$ s Rise Time: 1ns
	Electrostatic Discharge Immunity	6.0kV (EN61000-4-2 level3 compliant)
	Surge Resistance	Normal Mode: 1 kV / Common Mode: 2kV (IEC61000-4-5 level3 compliant)

### 2.1.3 Structural specifications

Items		Specifications
Installation	Grounding	100 $\Omega$ or less, or your country's applicable standard.
	Structure	Rating <sup>*1</sup> : Equivalent to IP65f (JEM 1030)
	External Dimensions	W395mm [15.55in.] × H294mm [11.57in.] × D60mm [2.36in.]
	Weight	Approx. 7.0kg [15.43lb]
	Cooling Method	Natural air circulation

\*1 The front face of the FP unit, installed in a solid panel, has been tested using conditions equivalent to the standards shown in the specification. Even though the FP unit's level of resistance is equivalent to these standards, oils that should have no effect on the FP can possibly harm the unit. This can occur in areas where either vaporized oils are present, or where low viscosity cutting oils are allowed to adhere to the unit for long periods of time. If the FP's front face protection sheet becomes peeled off, these conditions can lead to the ingress of oil into the FP and separate protection measures are suggested. Also, if non-approved oils are present, it may cause deformation or corrosion of the front panel's plastic cover. Therefore, prior to installing the FP be sure to confirm the type of conditions that will be present in the FP's operating environment.

If the installation gasket is used for a long period of time, or if the unit and its gasket are removed from the panel, the original level of the protection cannot be guaranteed. To maintain the original protection level, be sure to replace the installation gasket regularly.



## 2.2 Functional Specifications

### 2.2.1 Performance

Items		Specifications
Graphics		XGA (1024 × 768)
Display Unit		15 inch TFT XGA
Touch Panel I/F	Type	Resistive Film (Analog)
	Resolution	1024 × 1024
	Service Life	1,000,000 times or more
	Interface	Serial Interface (RS-232C) USB Interface (Type-B connector)
Video I/F		Analog RGB Interface DVI-D Interface

### 2.2.2 Display

Items	Specifications
Size	38cm(15 in.) (Meas. diagonally)
Type	TFT Color LCD
Resolution	1024(H) × 768(V) pixels (1pixel =R+G+B color dots)
Dot Pitch	0.297mm [0.01in.] × 0.297mm [0.01in.]
Display Colors	16,777,216 colors(R+G+B color 8 bits each)
Brightness Control	Available
Contrast Control	Available
Display Area	304.1 mm [11.97 in.] (W) × 228.1 mm [8.98 in.] (H)
Display Modes	640×400, 640×480, 720×400, 800×600,1024×768
Backlight	CCFL
Backlight Lifetime	Backlight is replaceable. 50,000 hours at an ambient temperature of 25°C*1

\*1 50% decreased brightness indicates the backlight needs to be replaced. This value is only for reference and not a guaranteed value.

## 2.3 Interface Specifications

### 2.3.1 Analog RGB Interface

Input signal type	Analog RGB
Input signal characteristic	Image signal: analog RGB Synchronous signal: TTL level, negative polarity or positive polarity Scanning type: non-interlaced
Setting via OSD (On Screen Display)	<ul style="list-style-type: none"> <li>• CONTRAST</li> <li>• H-POSITION</li> <li>• H-size</li> <li>• DIMMER (BACKLIGHT)</li> <li>• ALL RESET (DEFAULT)</li> <li>• BRIGHTNESS</li> <li>• V-POSITION</li> <li>• PHASE</li> <li>• SHARPNESS</li> </ul>

#### ■ Display Area

The number of dots (pixels) displayed are as follows.

Size	H.Sync. (kHz)	V.Sync. (Hz)	Dot Clock (MHz)	Screen Resolution Expansion (H: Horizontal) (V: Vertical)	Display Resolution
640 × 400	24.827	56.420	21.053	× 1.6(H) × 1.92(V)	1024 × 768
640 × 400	31.469	70.000	25.175		
640 × 480	31.469	59.992	25.175	× 1.6	
640 × 480	37.500	75.000	31.500		
640 × 480	35.000	66.670	30.240		
720 × 400*1	31.469	70.000	28.320	× 1.42(H) × 1.92(V)	
800 × 600	37.879	60.317	40.000	× 1.28	
800 × 600	46.875	75.000	49.500		
1024 × 768	48.363	60.004	65.000	× 1.0	
1024 × 768	56.476	70.069	75.000		
1024 × 768	60.023	75.029	78.750		

\*1 When you use this resolution, set "ON" for "720 × 400 Mode" in the OSD (On Screen Display) system settings.

Analog RGB Interface Pin Assignments and Signal Names

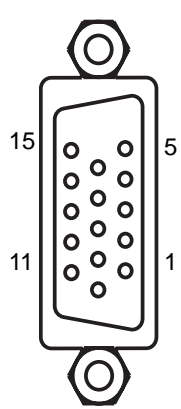
Pin No.	Signal Name	Condition	Pin Location
1	Analog R	R signal input	
2	Analog G	G signal input	
3	Analog B	B signal input	
4	Reserved	NC (spare for input)	
5	Digital grounding	Digital signal GND	
6	Return R	R signal GND	
7	Return G	G signal GND	
8	Return B	B signal GND	
9	Reserved	NC (spare for input)	
10	Digital grounding	Digital signal GND	
11	Reserved	NC (spare for input)	
12	DDC DATA	DDC Data	
13	H. SYNC	Horizontal synchronous signal input	
14	V. SYNC	Vertical synchronous signal input	
15	DDC CLOCK	DDC Clock	

Connector.....:Mini Dsub 15pin male

Connector set screw .....:Inch type (4-40)

Cable.....:RGB cable manufactured by Pro-face  
(FP CV02-45 <4.5m>)(VGA standard)

**IMPORTANT** • If a cable other than the specified RGB cable is used, product performance cannot be guaranteed due to the possibility of noise interfering with the FP unit's operation.

## 2.3.2 DVI-D Interface

Input signal type	DVI-D
Setting by OSD (On Screen Display)	<ul style="list-style-type: none"> <li>• CONTRAST</li> <li>• SHARPNESS</li> <li>• ALL RESET (DEFAULT)</li> <li>• BRIGHTNESS</li> <li>• DIMMER (BACKLIGHT)</li> </ul>

## ■ Display Area

The number of dots (pixels) displayed are as follows:

Size	H.Sync. (kHz)	V.Sync. (Hz)	Dot Clock (MHz)	Screen Resolution Expansion (H: Horizontal) (V: Vertical)	Display Resolution
640 × 400	24.827	56.420	21.053	× 1.6(H) × 1.92(V)	1024 × 768
640 × 400	31.469	70.000	25.175		
640 × 480	31.469	59.992	25.175	× 1.6	
640 × 480	37.500	75.000	31.500		
640 × 480	35.000	66.670	30.240		
720 × 400 <sup>*1</sup>	31.469	70.000	28.320	× 1.42(H) × 1.92(V)	
800 × 600	37.879	60.317	40.000	× 1.28	
800 × 600	46.875	75.000	49.500		
1024 × 768	48.363	60.004	65.000	× 1.0	
1024 × 768	56.476	70.069	75.000		
1024 × 768	60.023	75.029	78.750		

\*1 When you use this resolution, set "ON" for "720 × 400 Mode" in the OSD (On Screen Display) system settings.

■ DVI-D Interface Pin Assignments and Signal Names

Pin No.	Signal Name	Pin No.	Signal Name	Pin Location
1	TMDS DATA2-	13	NC	
2	TMDS DATA2+	14	NC	
3	TMDS DATA2 SHIELD	15	GND	
4	NC	16	Hot Plug Detect	
5	NC	17	TMDS DATA0-	
6	DDC Clock	18	TMDS DATA0+	
7	DDC Data	19	TMDS DATA0 SHIELD	
8	NC	20	NC	
9	TMDS DATA1-	21	NC	
10	TMDS DATA1+	22	TMDS CLOCK SHIELD	
11	TMDS DATA1 SHIELD	23	TMDS CLOCK+	
12	NC	24	TMDS CLOCK-	

Connector.....DVI-D 24-pin male

Connector set screw .....Inch type (4-40)

Cable.....DVI-D cable manufactured by Pro-face  
(FP-DV01-50 <5 m>, FP-DV01-100 <10 m>)

**IMPORTANT**

- If a cable other than the specified DVI-D cable is used, product performance cannot be guaranteed due to the possibility of noise interfering with the FP unit's operation.
- The FP-DV01-100 can be used only when connected to a PS-2000B unit. When using the FP-DV01-100, be sure to turn the PS-2000B's internal dipswitch 4 ON (When using the FP-DV01-50, turn this switch OFF).

### 2.3.3 Serial Interface

Serial Interface	Baud rate : 9600 bps
	Data length : 8 bits
	Parity : none
	Stop bit : 1
	Flow control : None

#### ■RS-232C Interface Pin Assignments and Signal Names

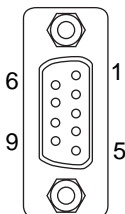
Pin No.	Signal Name	Condition	Pin Location
1	CD	Carrier Detect *1	
2	RD	Receive Data (FP->Host)	
3	SD	Send Data (FP<-Host)	
4	DTR	Data Terminal Ready*1	
5	GND	Ground	
6	DSR	Data Set Ready *1	
7	RS	Request to Send (FP<-Host)	
8	CS	Clear to Send (FP->Host)	
9	NC	(Used internally)	

\*1 CD, DTR, and DSR are connected together inside of the FP.

Connector .....Dsub 9 pin female

Connector set screw .....Inch type (4-40)

Cable .....SIO cable manufactured by Pro-face  
(FP61V-IS00-O)

#### NOTE

- Concerning Signal Names

Signal names used for the serial interface on FP units are designed to match the pin order used on most PC serial interfaces, so that a straight cable can be used to connect the two. Therefore, connect each pin's signal to the same signal name on the PC side.

For example, pin #2 'RD' should be connected to the 'RD' input terminal on the PC's connector.

Refer to section "2.4 Cable Diagrams" for each signal's direction.



2.4 Cable Diagrams (page2-11)

#### IMPORTANT

- If a cable other than the specified RS-232C cable is used, product performance cannot be guaranteed due to the possibility of noise interfering with the FP unit's operation.

### 2.3.4 USB Interface (Up-stream port)

#### ■USB Interface Pin Assignments and Signal Names

Pin No.	Signal Name	Condition	Pin Location
1	USB1-5V	+5VIN	
2	USBD1(-)	USB data(-)	
3	USBD1(+)	USB data(+)	
4	GND	Ground	

Connector..... USB 2.0 / USB 1.1 compliant

Connector set screw ..... Type B connector

Cable..... USB cable manufactured by Pro-face  
(FP-US00)

**IMPORTANT**

- If a cable other than the specified USB cable is used, product performance cannot be guaranteed due to the possibility of noise interfering with the FP unit's operation.

For using USB Interface, equal to or higher version of a Windows®2000(SP4) or Windows®XP(SP1) is required.

### 2.3.5 Front USB Interface (Down-stream port)(FP3710-T41-U model only)

#### ■USB Interface Pin Assignments and Signal Names

Pin No.	Signal Name	Condition	Pin Location
1	USB1-5V	+5VIN	
2	USBD1(-)	USB data(-)	
3	USBD1(+)	USB data(+)	
4	GND	Ground	

Connector..... : USB 2.0 / USB 1.1 compliant

Connector set screw ..... : Type A connector

## 2.4 Cable Diagrams

### 2.4.1 RGB Interface Cable Pin Connections (Option cable: VGA standard)

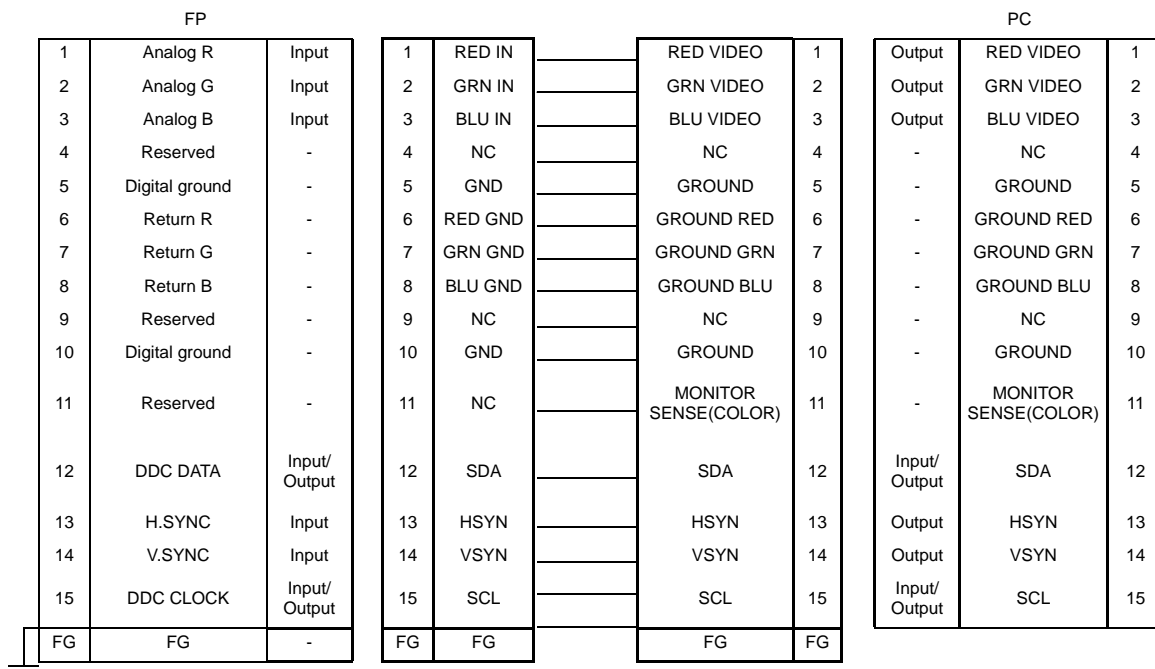

Signals and signal names used with the FP and the RGB cable (optional cable) are the same as those used for PCs. Also, the same pin is used on both sides of the optional cable so that you can connect the cable regardless of the cable direction.

Inch is used for the pitch of the connector screw on the PC. For this reason, inch (4-40) is also used for the pitch of the connector screw for the cable and the FP.



## 2.4.2 DVI-D Interface Cable Pin Connections (Option cable)

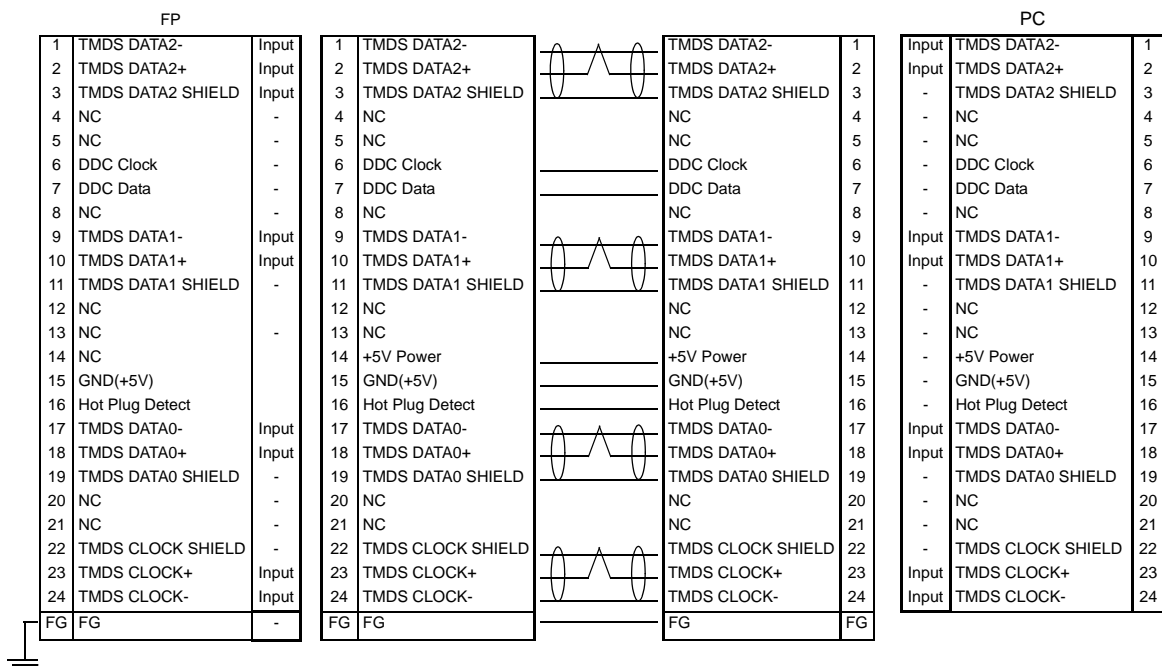

Signals and signal names used with the FP and the DVI-D cable (optional cable) are the same as those used for PCs. Also, the same pin is used on both sides of the optional cable so that you can connect the cable regardless of the cable direction.

Inch is used for the pitch of the connector screw on the PC. For this reason, inch (4-40) is also used for the pitch of the connector screw for the cable and the FP.

**NOTE**

- The FP-DV01-100 cable's 6, 7, 14 and 15 pins are not connected.

### 2.4.3 SIO Interface Cable Pin Connections

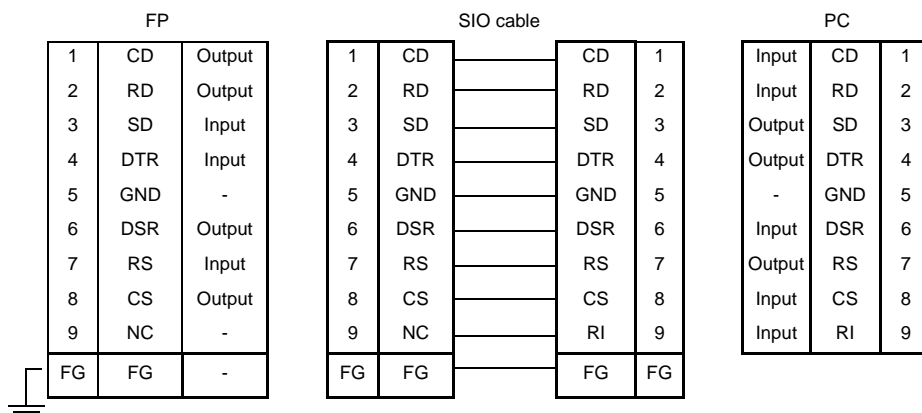

Signals and signal names used with the FP and the SIO cable (optional cable) are the same as those used for PCs. Also, the same pin is used on both sides of the optional cable so that you can connect the cable regardless of the cable direction.

Inch is used for the pitch of the connector screw on the PC. For this reason, inch (4-40) is also used for the pitch of the connector screw for the cable and the FP.

### 2.4.4 USB Interface Cable Pin Connections

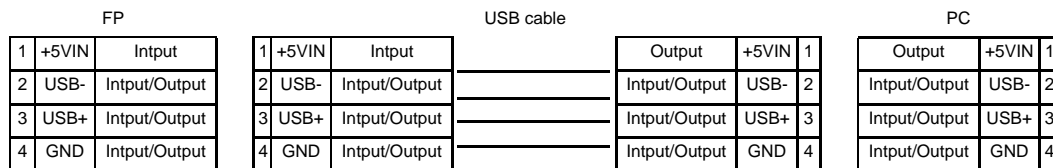

## 2.5 Names and Functions

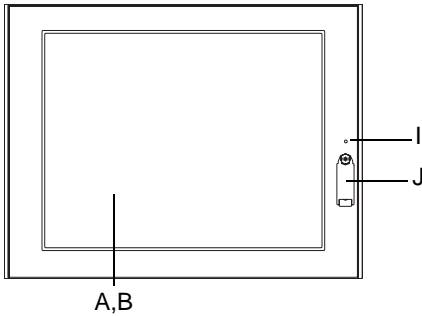

Rear

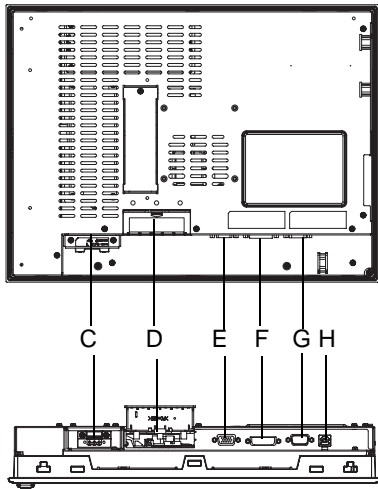

Bottom

**A:TFT Color LCD**

The display monitor for your host unit.

**B:Touch Panel**

Allows you to switch screens or write data to the host.

**C:Power Connector (socket)**

Provides the input and ground terminals for a power cable.

**D:Setting Switch**

By opening the cover, the Dip switches and slide switch are seen. Each switch can set a operation mode.

**SEE →** 4.1 Operation Mode Setup (page4-2)

**E:Analog RGB Connector**

Connector for analog RGB interface

**F:DVI-D Interface Connector**

Connector for DVI-D interface

**G: Serial Connector**

Connector for Serial (RS-232C) interface. Used for sending touch panel data to between the hosts.

**H:USB Connector (Type B)**

Connector for USB interface. Used for sending touch panel data to the hosts, or used as an upstream port for USB-HUB.

**I: Front LED**

Used to indicate the condition of the power supply, a backlight burnout or image signal input.

**SEE →** 4.1.2 Status of Front LED in Operation Modes (page4-3)

**J: FrontUSB Connector (Type A)(FP3710-T41-U only)**

A downstream port for embedded USB-HUB in conformity with USB2.0/1.1 standard, which is used for connecting USB devices. Connect the USB connector (H:USB connector) and Host PC for Front USB connector use.

## 2.6 Dimensions

### 2.6.1 External Dimensions

Unit: mm [in.]

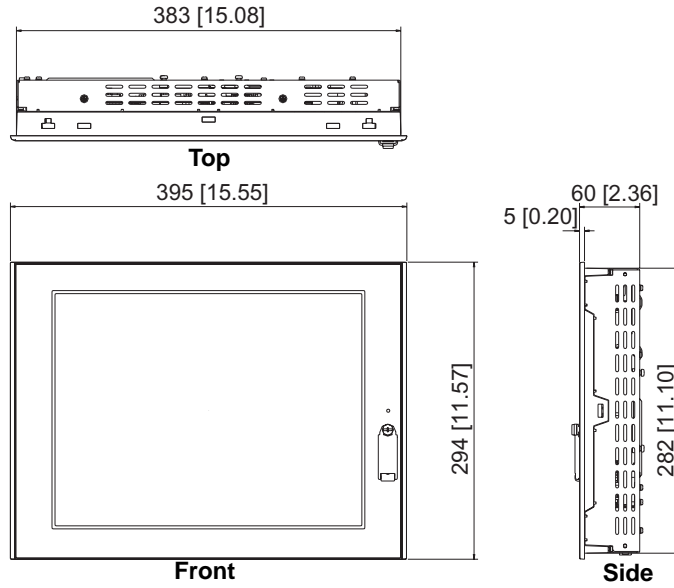

### 2.6.2 Dimensions with installation fasteners

Unit: mm [in.]

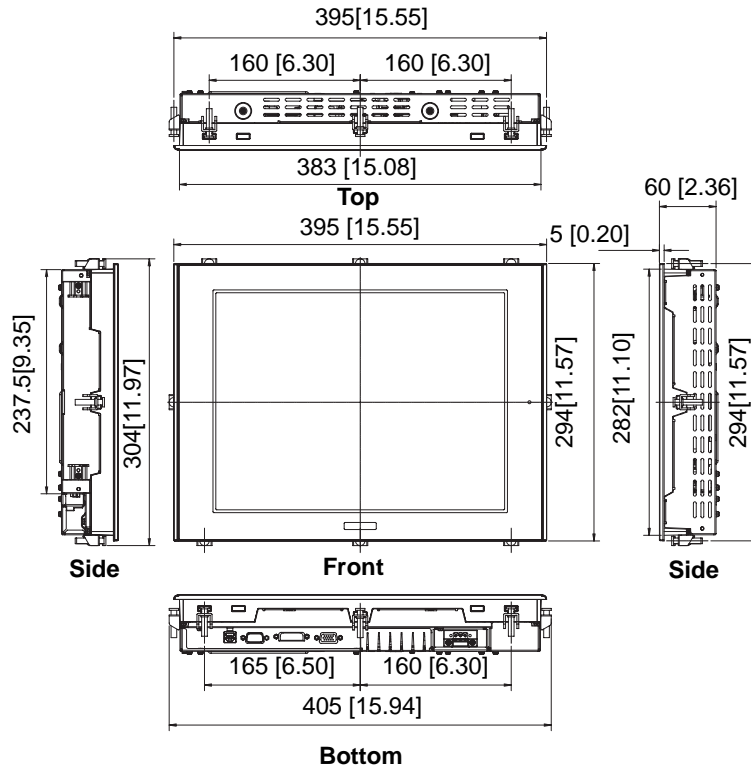

### 2.6.3 Dimensions with Cables

Unit: mm [in.]

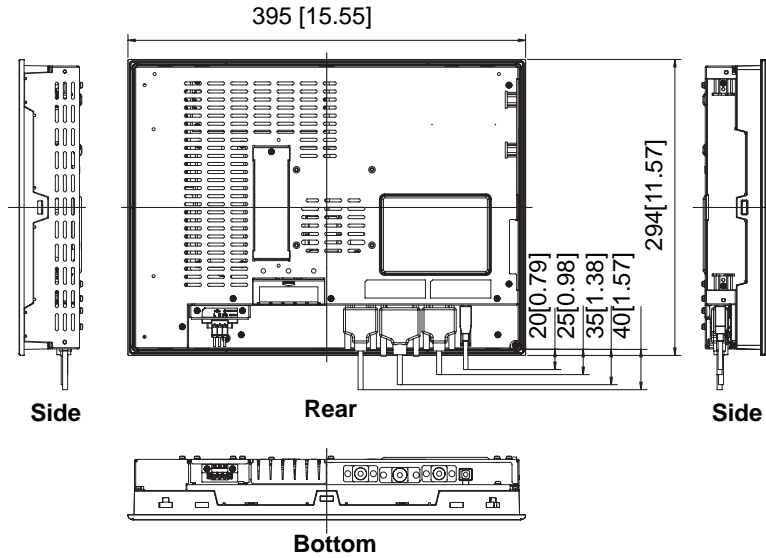

### 2.6.4 Installation Fasteners

Unit: mm [in.]

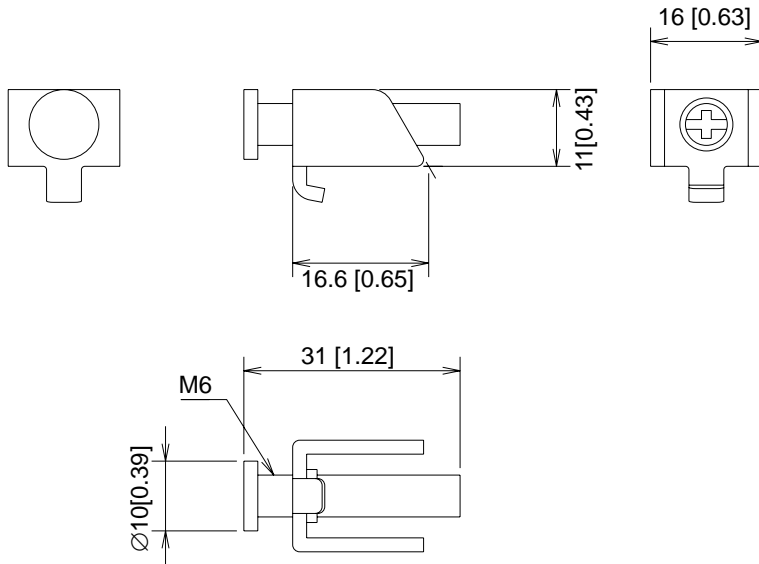

## 2.6.5 Panel Cut Dimensions

Unit: mm [in.]

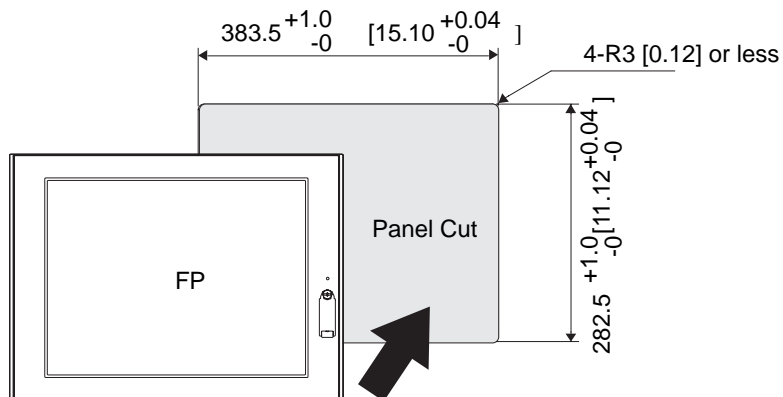

- IMPORTANT**
- Panel thickness should be between 1.6mm [0.06in.] and 10mm [0.39in.]. Decide the panel's thickness based on the level of panel strength required.
  - Check that the installation panel or cabinet's surface is flat, in good condition and has no jagged edges.
  - Create the correct sized opening required to install the FP, using the installation dimensions given.
  - If desired, metal reinforcing strips can be attached to the inside of the panel, near the Panel Cut, to increase the panel's strength.

**SEE →** 2.1.3 Structural specifications (page2-3)



# 3



# Installation and Wiring

1. Installation
2. Wiring

This chapter explains the installation method and the wiring method for the FP.



### 3.1 Installation

#### 3.1.1 Installation Procedures

Follow the steps given below when installing the FP.

#### ■ Check the Installation Gasket's Seating

It is strongly recommended that you use the installation gasket, since it absorbs vibration in addition to repelling water.

Place the FP on a level surface with the display panel facing downward. Check that the FP's installation gasket is seated securely into the gasket's groove, which runs around the perimeter of the panel's frame.

For details about installing the gasket, refer to

**SEE →** 7.1.2 Installation Gasket Replacement (page7-3)

**IMPORTANT**

- Before installing the FP into a cabinet or panel, check that the installation gasket is securely attached to the unit.
- A gasket which has been used for a long period of time may have scratches or dirt on it, and can lose much of its dust and drip resistance. Be sure to change the gasket periodically (or when scratches or dirt become visible).
- Be sure to use gasket model CA3-WPG15-01.
- Be sure the gasket's seam is not inserted into any of the unit's corners, only in the straight sections of the groove. Inserting it into a corner may lead to its eventually tearing.
- To ensure the installation gasket's maximum level of moisture resistance, be sure the gasket's seam is inserted as shown into the panel's bottom face.

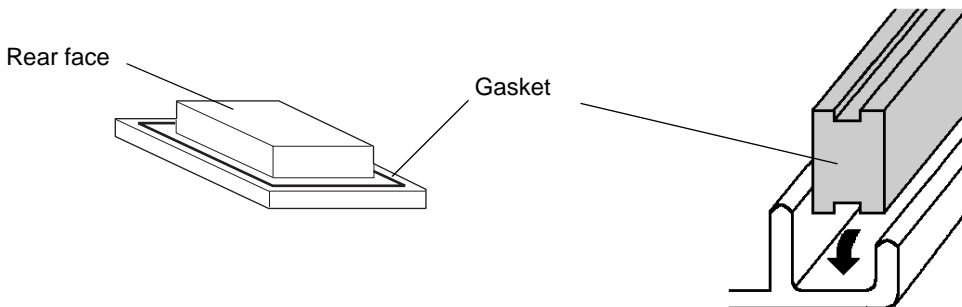

■ Creating a Panel Cut

Create the correct sized opening required to install the FP, using the installation dimensions given.

**SEE →** 2.6.5 Panel Cut Dimensions (page2-17)

The installation gasket, installation fasteners and attachment screws are all required when installing the FP.

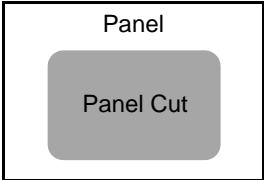

**NOTE** • Check that the installation panel or cabinet’s surface is flat, in good condition and has no jagged edges. Also, if desired, metal reinforcing strips can be attached to the inside of the panel, near the Panel Cut, to increase the panel’s strength.

**IMPORTANT** • Panel thickness should be from 1.6mm [0.06in.] to 10mm [0.39in.]. Decide the panel's thickness based on the level of panel strength required.

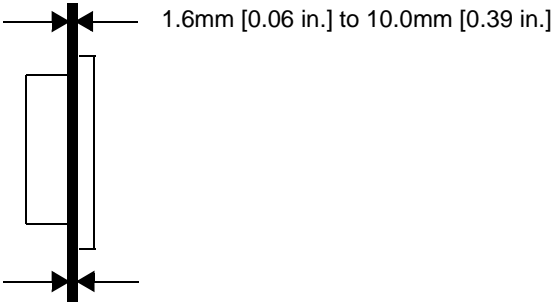

• For easier maintenance, operation, and improved ventilation, be sure to install the FP at least 100 mm [3.94 in.] away from adjacent structures and other equipment.

Unit: mm  
[in.]

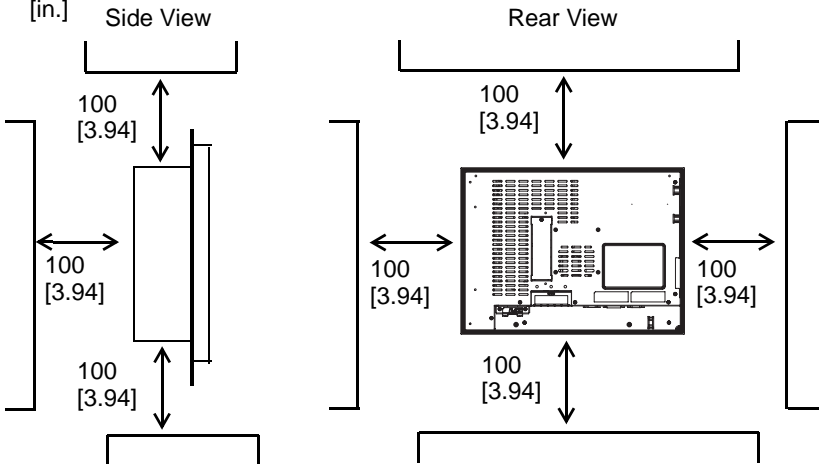

**IMPORTANT**

- Be sure that the ambient operating temperature and the surrounding operating humidity are within their designated ranges. (When installing the FP in a cabinet or an enclosure, "Ambient operation temperature" indicates both the panel face and cabinet or enclosure's internal temperature.).

Unit: mm  
[in.]

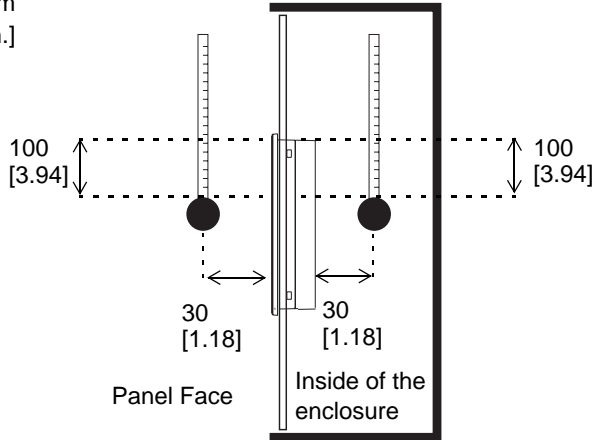

Ambient Operating Temperature: 0 to 50°C  
Surrounding Operating Humidity: 10 to 90%RH

- Be sure that heat from surrounding equipment does not cause the FP to exceed its standard operating temperature.
- When installing the FP in a slanted panel, the panel face should not incline more than 30°.

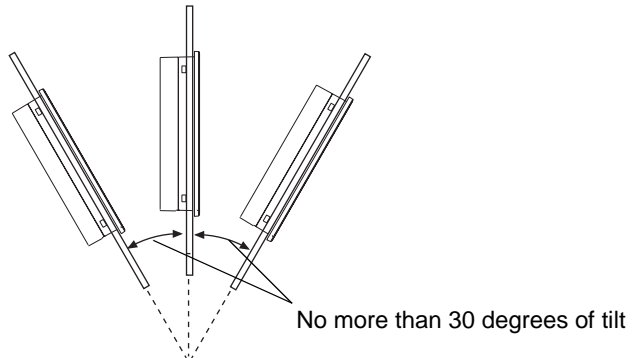

- When installing the FP in a slanted panel, and the panel face inclines more than 30°, the ambient temperature must not exceed 40 °C. You may need to use forced air cooling (fan, A/C) to ensure the ambient operating temperature is 40 °C or below.

■ Installing the FP

- (1) Insert the FP into the panel cut, as shown here.

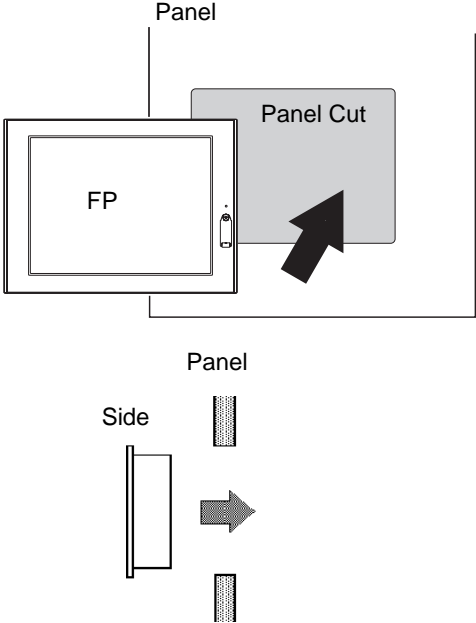

- (2) Insert the installation fasteners into the FP's insertion slots, at the top and bottom of the unit. (total: 8 slots)

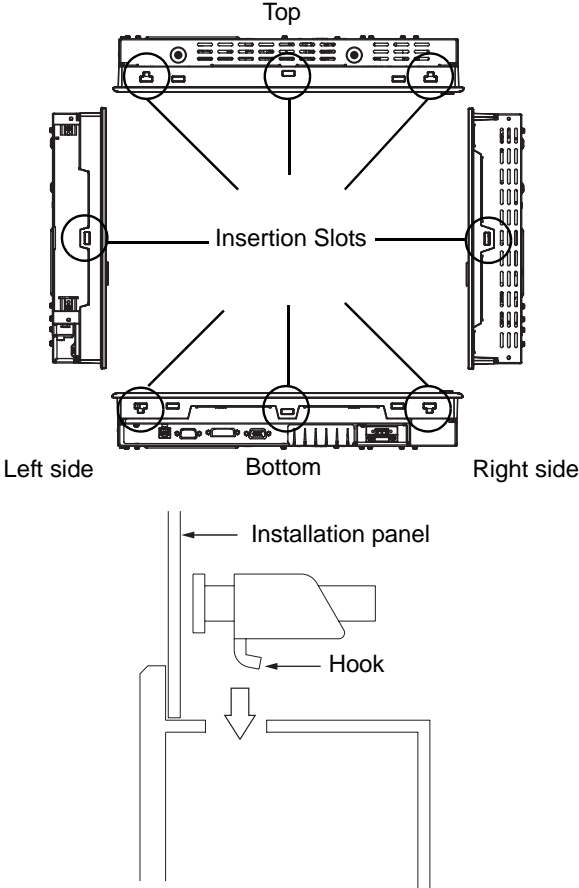

- (3) Insert each of the fasteners as shown below. Be sure to pull the fastener back until it is flush with the rear of the attachment hole.

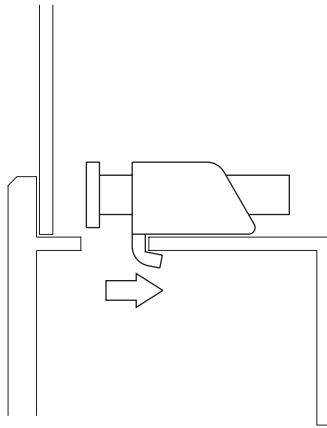

- (4) Use a Phillips screw driver to tighten each fastener screw and secure the FP in place.

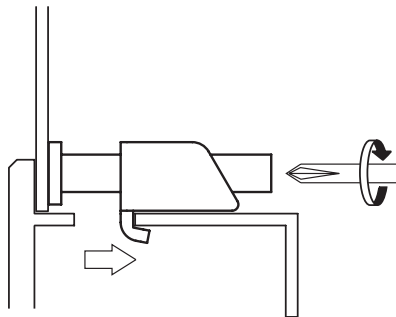

- IMPORTANT** • Do not use too much force, since it may damage the FP unit. A torque of only 0.5 N•m is sufficient to tighten these screws.

## 3.2 Wiring

### 3.2.1 Connecting the Power Cord

#### ⚠ WARNING

- ❗ To avoid an electric shock, when connecting the FP's power cord terminals to the power terminal block, confirm that the FP's power supply is completely turned OFF, via a breaker, or similar unit.
- ❗ To avoid the dangers of fire, electric hazards and equipment damage, be sure to use only the specified voltage when operating the FP.
- ❗ Since there is no power switch on the FP unit, be sure to attach a breaker-type switch to its power cord.

#### ◆ Power Cable specification

Use copper conductors only.

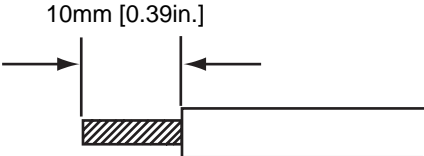
Power Cord Diameter	0.2mm <sup>2</sup> to 2.5mm <sup>2</sup> [0.0001 to 0.0097inch <sup>2</sup> ] (24AWG to 12 AWG)
Conductor Type	Simple or Twisted Wire
Conductor Length	

**IMPORTANT** • If the Conductor's end (individual) wires are not twisted correctly, the end wires may either short against each other, or against an electrode.

#### ◆ Power connector specification

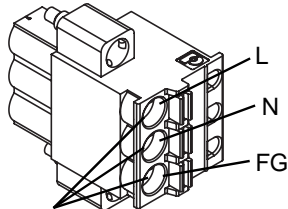
 <p>Power Cable Joint</p>	L	AC Input Terminal-live line
	N	AC Input Terminal-neutral line
	FG	Ground Terminal connected to the FP chassis

**NOTE** • Kind of power cord is FKC 2,5/3-STF-5,08 which are Phoenix Contact<sup>\*1</sup> products.

\*1 Please contact Phoenix Contact for the details.

◆ Wiring

Use the following wiring for FP. Those are Phoenix Contact products.

Recommended Drivers	SZS 0.6X3.5 (1205053)
Recommended stick end terminal	AI 0.34-12TQ(3200645)
	AI 0.5-10WH(3201275)
	AI 0.75-10GY(3201288)
	AI 1-10RD(3200182)
	AI 1.5-10BK(3200195)
	AI 2.5-12BU(3200962)
Crimp tool for recommended stick end terminal	CRIMPFOX ZA 3 (1201882)

◆ Connecting the Power Cord

When connecting the AC type power cord, be sure to follow the procedures given below.

- (1) Confirm that the power cord is unplugged from the power supply.
- (2) Push the Opening button by a small and flat screw driver to open the desired pin hole.
- (3) Insert each pin terminal into its each hole. Release the Opening button to clamp the pin place.

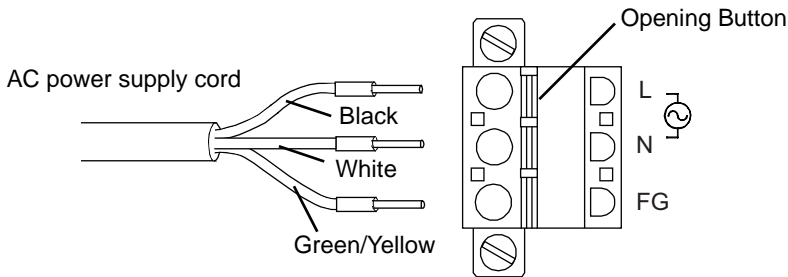

**IMPORTANT**

- The Power Cord included in the FP unit's package is designed only for AC100V or AC115V use. Any other voltage will require a different cord.

- (4) After inserting all three pins, insert the Power Plug into the Power Connector at FP. Fix the plug with two(2) minus screws.

**IMPORTANT**

- Confirm that all wires are connected correctly.
- The torque required to tighten these screws is 0.5 N•m - 0.6 N•m.
- To prevent the possibility of a terminal short, use a pin terminal that has an insulating sleeve.

### 3.2.2 The USB Cable Clamp

#### ■ How to use the USB cable clamp

##### ◆ USB Cable Clamp Attachment Procedure

- (1) Connect the USB cable to the connector.
- (2) Insert the cable clamp into the cable clamp holder as shown in figure 1, and tighten the clamp until the cable is secured in place.

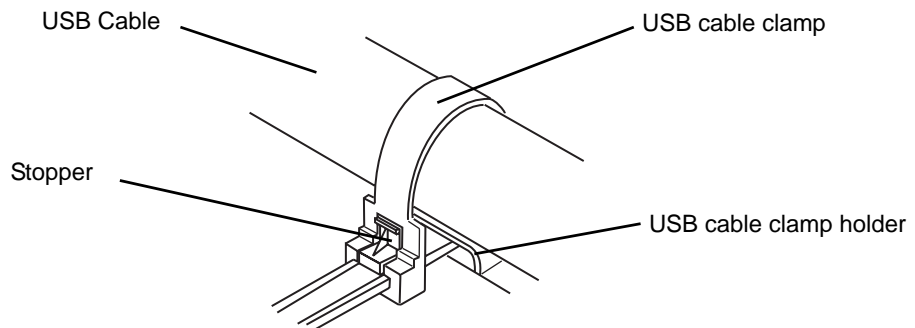

Figure 1

##### ◆ USB Cable Clamp Removal Procedure

- (1) Push in the cable clamp's stopper until the cable clamp is unlocked, then remove the clamp.
- (2) Disconnect the USB cable.



### 3.2.3 Connecting the Power Supply

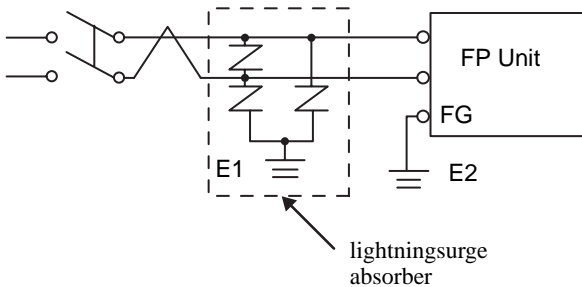
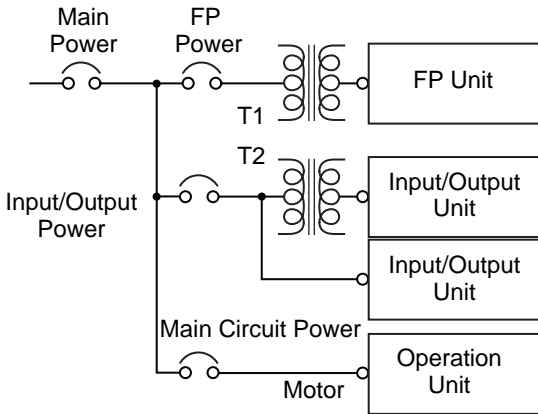
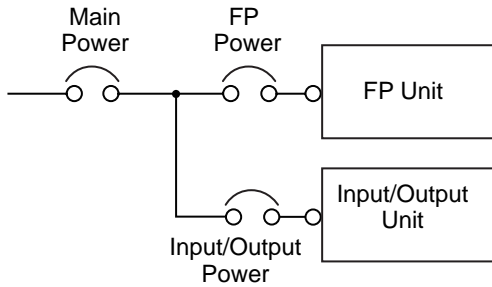
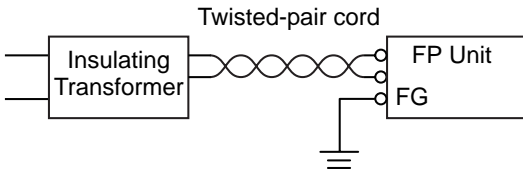
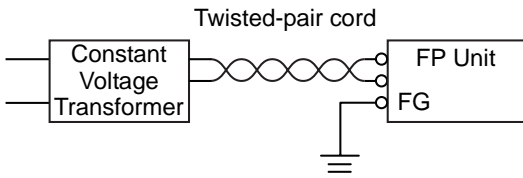

- If the power supply voltage exceeds the FP unit's specified range, connect a constant voltage transformer.

**SEE →** 2 Specifications (page2-1)

- For between the line and ground or between the lines, select a power supply that is low in noise. If there is an excess amount of noise, connect an insulating transformer.

**IMPORTANT**

- Use the constant voltage transformer and the insulating transformer with capacities of the rated value or more.

- When supplying power to the FP unit, please separate the input/output and operation unit lines, as shown.
- To increase the noise resistance quality of the power cable, simply twist each power wire before attaching the Ring Terminal.
- The power supply cable must not be bundled or positioned close to main circuit lines (high voltage, high current), or input/output signal lines.
- Connect a lightning surge absorber, as shown in the diagram, to deal with power surges.
- To avoid excess noise, make the power cable as short as possible.
- The temperature rating of field installed conductors: 75°C only.

**IMPORTANT**

- Be sure to ground the surge absorber (E1) separately from the FP unit (E2).
- Select a surge absorber that has a maximum circuit voltage greater than the power supply's peak voltage.

### 3.2.4 Precautions: Grounding

(a) Exclusive grounding (BEST)

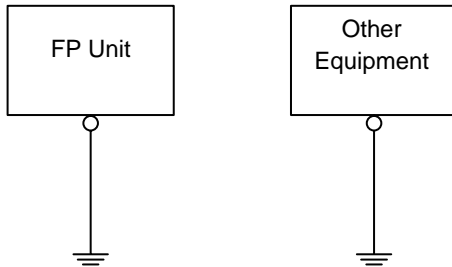

- Connect the FP's FG terminal to an exclusive ground. [diagram (a) - Grounding resistance of under 100Ω]

(b) Common grounding (OK)

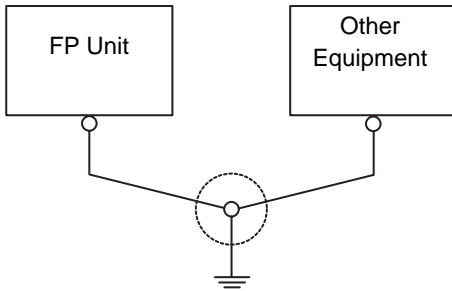

- If exclusive grounding is not possible, use a common connection point. [diagram (b)]
- The grounding wire should have a cross sectional area greater than 2mm<sup>2</sup>. Make the connection point as close to the FP unit as possible, and make the wire as short as possible. When using a long grounding wire, replace the thin wire with a thicker wire placed in a duct.

(c) Common grounding (BAD)

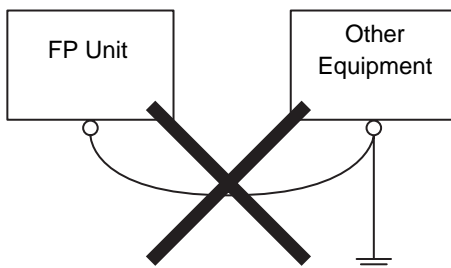

- If this equipment does not function properly when grounded, disconnect the ground wire from the FG terminal.

### 3.2.5 Precautions: Input/Output Signal Lines

- Input and output signal lines must be separated from operating circuit power cables.
- If this is not possible, use a shielded cable and connect the shield to the FP chassis.



# 4

## Setting up and Adjusting the FP unit

1. Operation Mode Setup
2. Screen Display Adjustment

This chapter describes the settings of the operation mode and the OSD.

## 4.1 Operation Mode Setup

### 4.1.1 Preset Settings and Adjustments for Dip Switch and Slide Switch

The Dip Switches and Slide Switch are located in the bottom of the FP unit. Only the settings when the power supply is turned on is effective to the Dip Switches and the Slide Switch. After changing the settings of the Dip Switches and the Slide Switch, be sure to restart your FP unit.

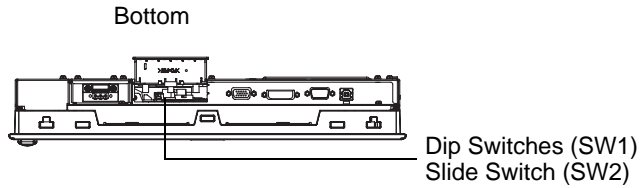

The factory default for the FP unit's Dip Switches and Slide Switch are as follows.

#### ■SW1

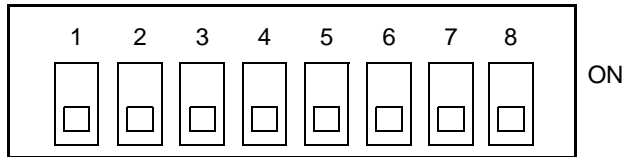

SW1-1	Reserved (Always OFF)
SW1-2	Display/Hide the OSD
SW1-3	Reserved (Always OFF)
SW1-4	Reserved (Always OFF)
SW1-5	Reserved (Always OFF)
SW1-6	Reserved (Always OFF)
SW1-7	Reserved (Always OFF)
SW1-8	Reserved (Always OFF)

- SW1-2

Dip Switch SW1-2 is used to display or hide the OSD.

To hide the OSD, set the switch to ON. To display the OSD, set the switch to OFF.

The default setting is OFF. (OSD is displayed.)

## ■SW2

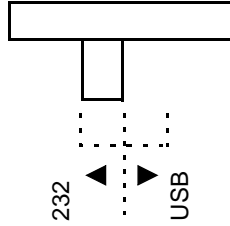

- Slide Switch is used to switch the data input/output (command control) method on the touch panel between USB and RS-232C.

The default setting is RS-232C.

### 4.1.2 Status of Front LED in Operation Modes

LED	OFF	Green	Orange	Green/ Red Flash	Orange Flash <sup>*1</sup>
Panel	Power OFF	Power ON	Power ON	Power ON	Power ON
Backlight	-	Normal	Normal	Burned-out	Burned-out
Input of Image	-	Yes	No	Yes	No

\*1 Only while “No signal” is displayed.

## 4.2 Screen Display Adjustment

### 4.2.1 Calibration of OSD Display Position

You can operate the FP screen menus via the touch panel, and adjust screen image display to a minute level. The feature is called OSD (On Screen Display).

This section describes items and functions that can be set with OSD.

(1) How to start the OSD

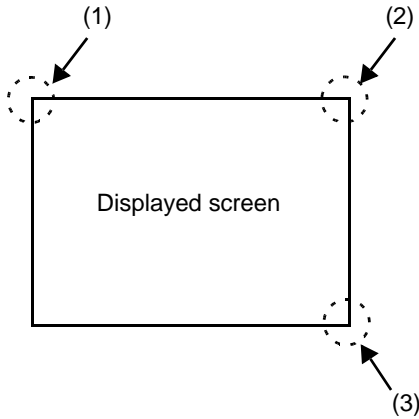

#### Starting the OSD

To start the OSD and enter OSD mode, press the three corners of the touch panel in the following order (upper left (1) a upper right (2) a lower right (3)) within 5 seconds. In OSD mode, the setting screen is displayed in the center of the screen. In this mode, the touch panel cannot be used to export data to external devices unless the settings for the OSD are completed.

**NOTE** • OSD is not displayed when a SW 1-2 is ON.

(2) Main Menu



"Ver. \*.\*.\*" indicates the version of the OSD.

#### Using the OSD

Icons on the screen are used to operate the OSD. When you start up the OSD, the top menu displays. Touching the icon of the item you want to adjust displays its submenu or setting change screen. In the setting change screen, left and right arrow icons are used to change the setting. To set the setting, press the **SET** button. Press the **SAVE** button to save the defined settings.

#### Quitting the OSD

To quit the OSD, press the **SAVE** or **EXIT** button in the top menu or leave the OSD as it is for at least 30 seconds.

**IMPORTANT**















- In the OSD, pressing the **SET** button applies the set value and enables the setting. The set value won't be canceled unless the power is turned OFF or the value is reset.

If the power is turned OFF without saving the set value, that data will disappear. The last saved data will be read into the system when the FP starts. To enable the changed value, be sure to press the **SAVE** button.

- All the setting values, even though in process of the OSD settings, will be retained in condition of letting the OSD leave more than 30 seconds or by pressing the **EXIT** button. The OSD will keep those values and make them effective until power-off or a Reset command input.



4.2.2 OSD Setting Icons

Item		Function
	Color Settings	Adjusts the contrast and the brightness.
	Screen Settings	Adjusts the display position of the screen. (Analog RGB only)
	Custom Display	Adjusts Sharpness and the backlight brightness.
	System Settings	Changes settings such as activating the click sound.
	All Reset	Resets the current OSD value to the default value.
	Input Source	Switches Analog RGB and DVI-D.
	Auto Adjust	Automatically adjusts the display position of the screen. (Analog RGB only)
	Auto Gain	Automatically adjusts the contrast and the brightness. (Analog RGB only)
	ESC	Cancels the setting and returns to the upper level.
	SET	Applies the setting and returns to the upper level.
	Arrow KEY	Changes the selection.
	SELECT	Selects icons or items.
	SAVE	Saves the current value and quits the OSD.
	EXIT	Quits the OSD.

## 4.2.3 OSD Setting Item Details

## ■ Main Menu

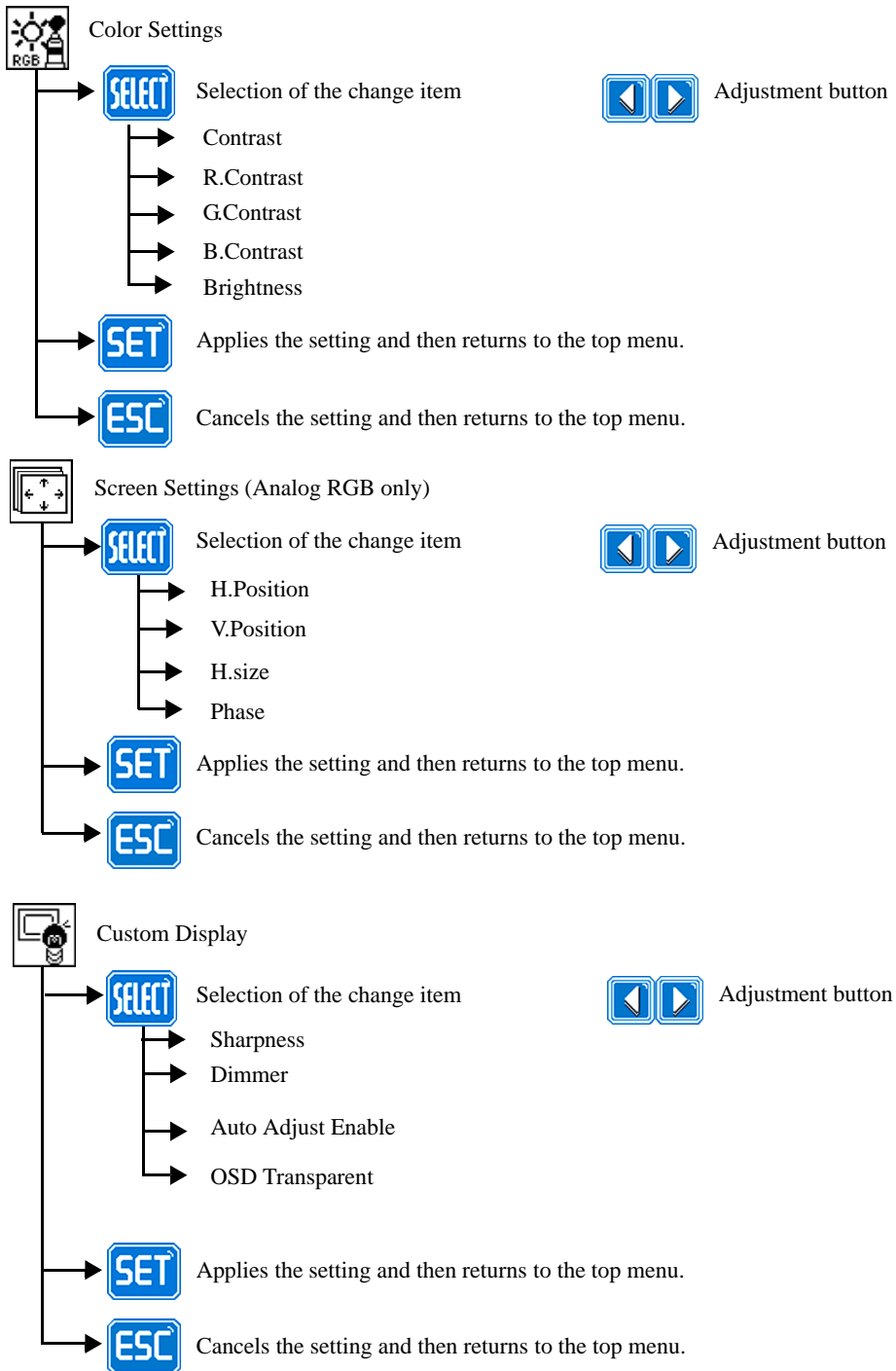

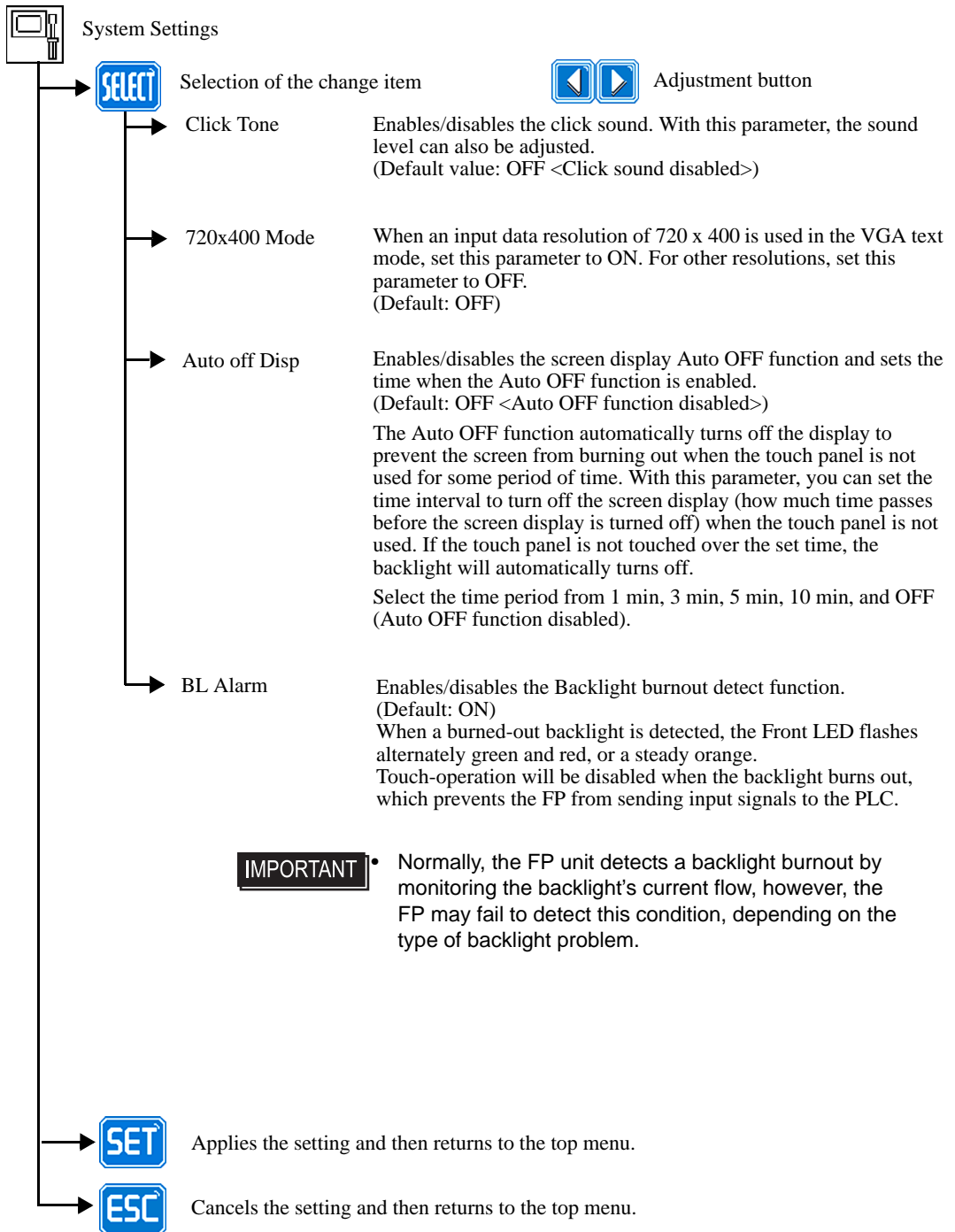

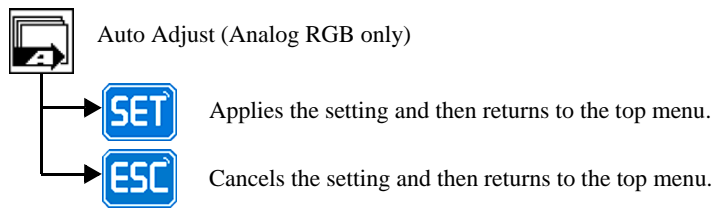
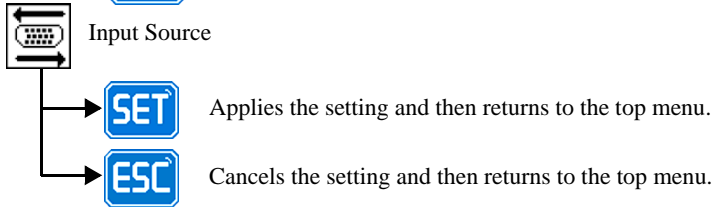
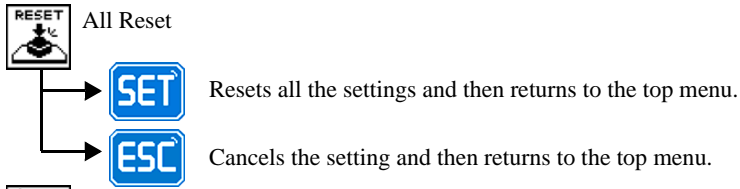

**IMPORTANT** • Be sure to perform the auto adjust while things except the black are displayed on the edge of the screen.

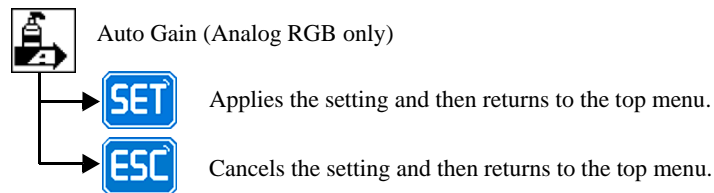

**IMPORTANT** • Be sure to perform the auto gain control when the screen has both 100% black and 100% white areas displayed.



Icon decision



Icon selection



Saves the setting and quits the OSD.      Saves all the adjusted settings in the EEPROM.



End of OSD

# MEMO

# 5 | Touch Panel Data

## 1. Touch Interface Data

This chapter describes the outline of the software to input the touch panel data to the host computer.

## 5.1 Touch Interface Data

The FP-3710T Series units use an analog type touch panel. This touch panel needs a calibration program to adjust the actual touch position.

The screen display origin point, with the resolution of 1024 x 768 for FP-3710T Series units, is normally at the upper left corner of the screen. Therefore, a software to convert the touch coordinates to display coordinates is needed.

OS	Touch I/F Program	Calibration
Windows®NT4.0 SP6a or newer ver. Windows®2000 Windows®XP	UPDD*1	Feature included in UPDD

\*1 The UPDD is used for both English and Japanese.

**IMPORTANT**

• Visit our support site below and download the mouse-emulation software (UPDD).

Digital Electronics Corporation's support site - Otasuke Pro!  
<http://www.pro-face.com/otasuke/>

### ■ Touch Panel Coordinate Data

(1) Resolution

Both the X and Y coordinates have a resolution of 1024.

The origin point (0,0) is located in the upper left corner of the screen.

<FP-3710T Series>

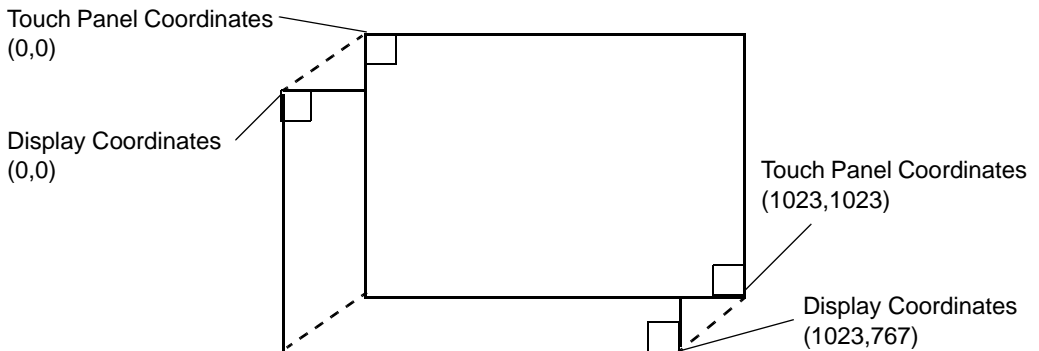

(2) Data Format

Touch Panel coordinate data is sent to the host using the following format.

All data is in binary format.

Header: 1 byte (11h = touched; 10h = released)

X coordinate: 2 bytes (0 to 3FFh)

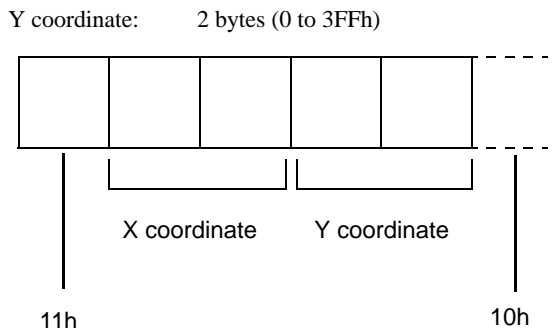

Added when touch is released.

<Example>

If the coordinate (X=23(11h), Y=500(1F4h)) is touched and moved to the coordinate (X=63(3Fh), Y=250(FAh)).

11h 0h 17h 1h F4h	touched
11h 0h 17h 1h F4h	continuous output with the same location
11h 0h 18h 1h F5h	moving without releasing touch
:	:
:	:
:	:
:	:
:	:
11h 0h 3Fh 1h FAh	continuous data output unless finger is released
11h 0h 3Fh 1h FAh 10h	when released, only 1 unit of data is sent



# MEMO

# 6



# Troubleshooting

1. Troubleshooting
2. Error Message

## 6.1 Troubleshooting

### 6.1.1 Possible Device Problems

This chapter explains the main method of dealing with the trouble in the use of the FP.

**NOTE**

- For problems other than problems of the FP, please refer to the manual of each equipment.

Possible types of trouble while using this unit are as follows.

#### No display

- No display appears after the unit is switched on.
- The screen disappears during standard operation.
- The screen does not display normally.

#### Touch panel does not respond

- The touch panel does not respond when pressed. Its reaction time is abnormally long.

---

 **WARNING**

---



To prevent an electric shock, be sure the power cord is not connected when wiring the unit.

**IMPORTANT**

- This section assumes that the FP is the cause of a problem, not the host. When the host is the problem, please refer to its corresponding manual.

## 6.1.2 No Display

When the screen does not display when powering up, or if the screen turns OFF by itself, use the flowchart below to find an appropriate solution.

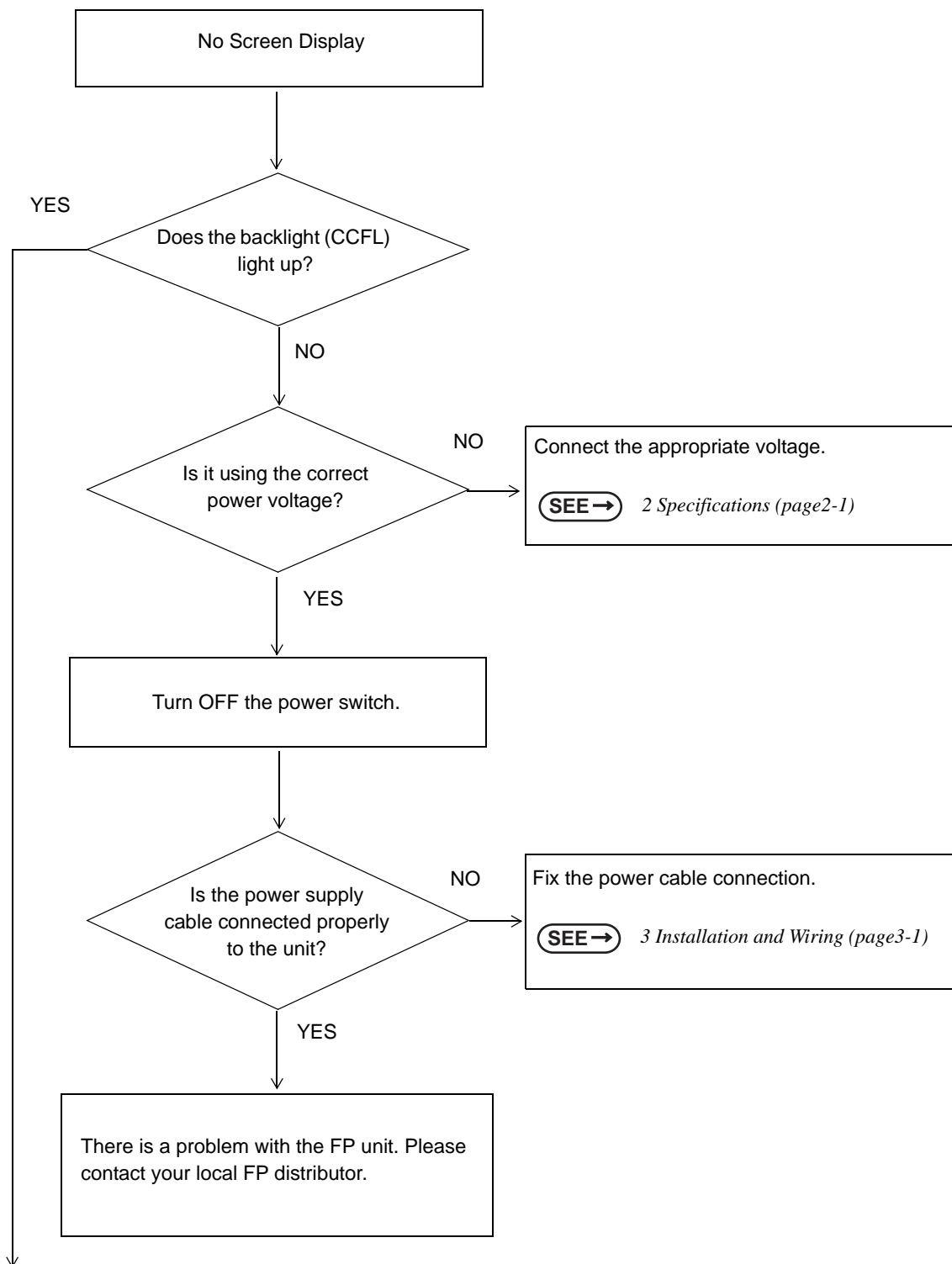

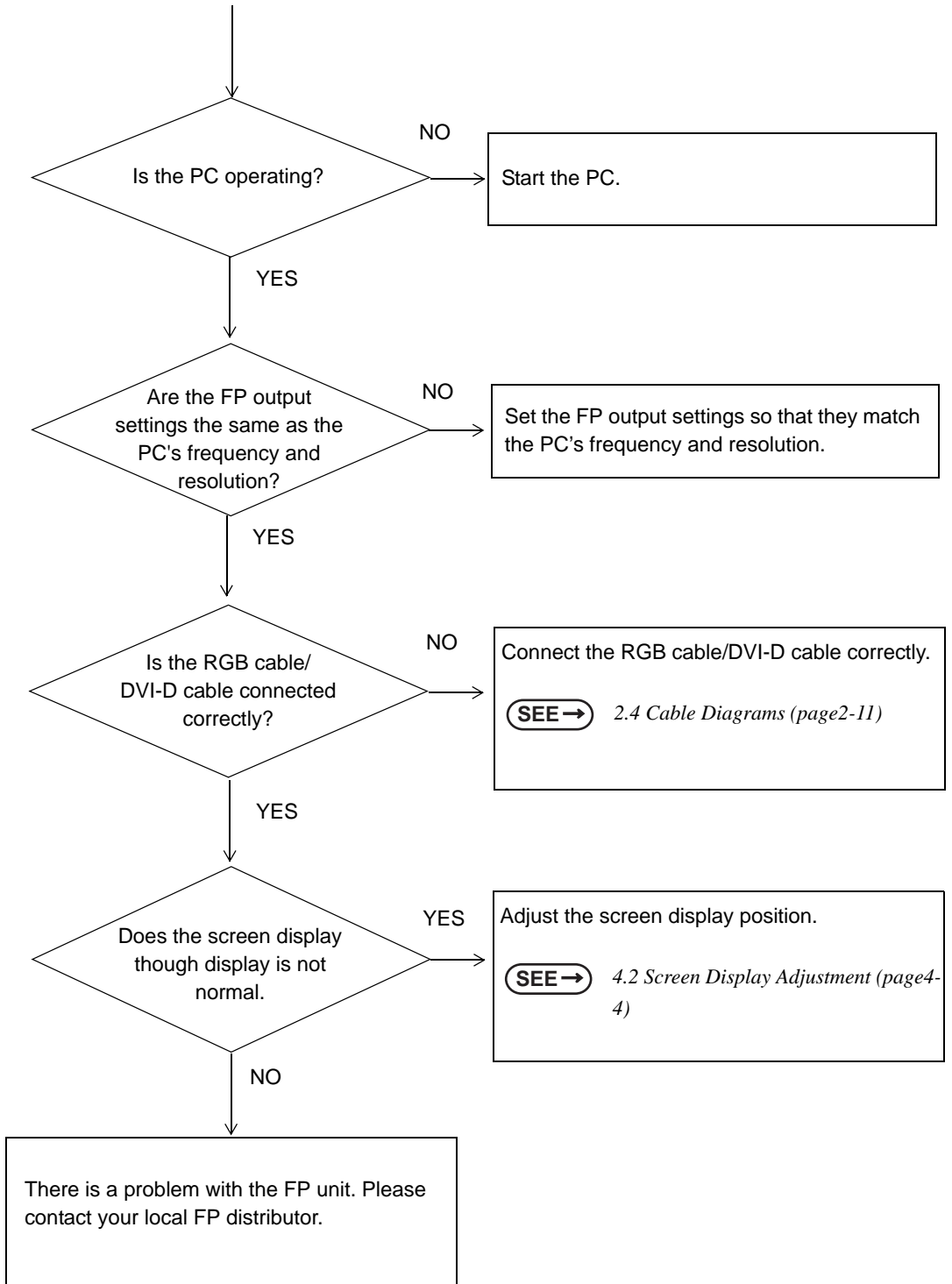

### 6.1.3 Touch Panel Does Not Respond

When the touch panel does not react, or its reaction is very slow after it is pressed, follow the flowchart below to find the origin of the problem and the appropriate solution.

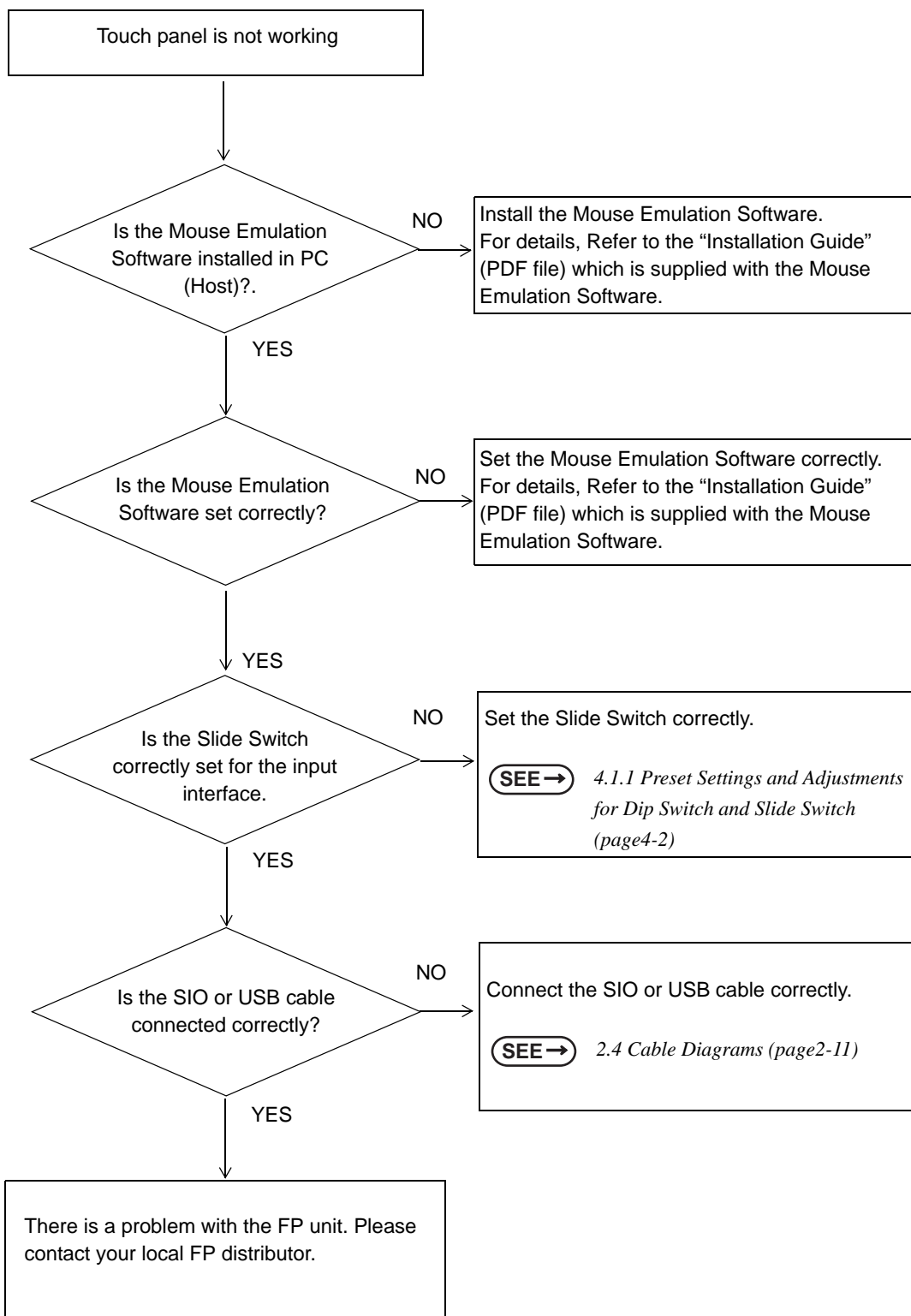

## 6.2 Error Message

This section explains the messages that appear when an error has occurred in the FP unit during RUN mode. The problem causing the error message and its related countermeasure are explained in the table below.

*(Only the latest error message will appear on the FP screen)*

### 6.2.1 Error Message List

Error Message	Problem	Solution
Out of range	Signal timing has been input that is not compatible with the FP unit.	Set the FP Output settings so that they match the PC's frequency and resolution.  <b>SEE →</b> 2.3 Interface Specifications (page2-5)
	The dot clock has greatly exceeded of the FP units usable timing range.	
	Resolution has been set that is not compatible with the FP unit.	
No signal	The PS-2000B unit or a Windows-compatible PC's power has not been turned ON.	Turn on the PS-2000B unit or a Windows-compatible PC's power.
	The PS-2000B unit or a Windows-compatible PC has not been correctly connected to the FP unit.	Connect the RGB cable/DVI-D cable correctly.

# 7 | Maintenance

1. Regular Cleaning
2. Periodic Check Points
3. Backlight Replacement

This chapter indicates necessary cautions and instruction standards to maintain your FP.



## 7.1 Regular Cleaning

### 7.1.1 Cleaning the Display

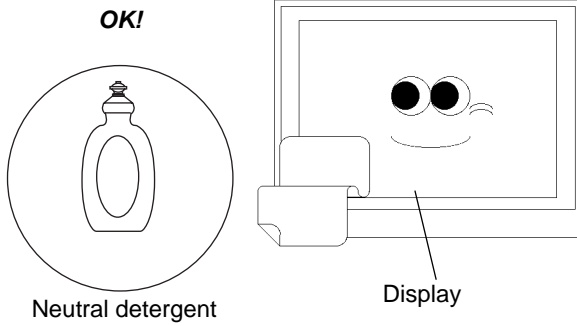

When the display surface or frame become dirty, use a soft cloth moistened with neutral detergent to wipe away any dust or stains.

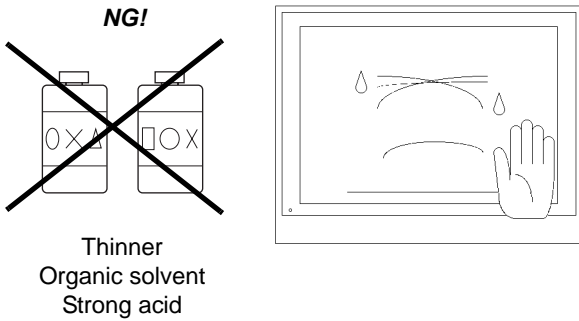

Do not clean the unit with thinner, organic solvents, or strong acids.

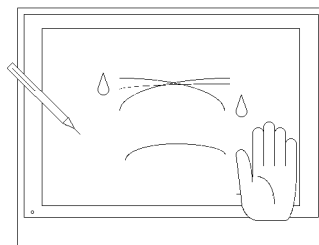

Do not use sharp or hard objects, such as a mechanical pencil or screwdriver, to push on the display. This could damage the unit.

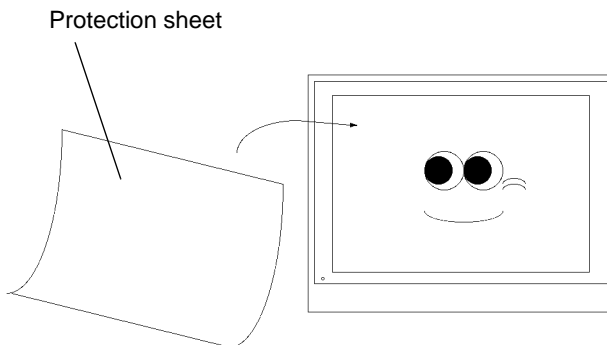

Attach the screen protection sheet when using the FP in extremely dirty or dusty areas.

## 7.1.2 Installation Gasket Replacement

The installation gasket protects the FP and improves its water resistance. For instructions on installing the FP unit's gasket, refer to the following page.

**SEE →** 3 *Installation and Wiring (page3-1)*

**IMPORTANT** • A gasket which has been used for a long period of time may have scratches or dirt on it, and could have lost much of its water resistance. Be sure to change the gasket at least once a year, or when scratches or dirt become visible.

### ■ Installation Gasket Replacement Procedure

- (1) Place the FP on a flat, level surface with the display facing downwards.
- (2) Remove the old gasket from the FP.
- (3) Attach the new gasket to the FP. Be sure to insert the gasket into the FP unit's groove so that the gasket's groove sides are vertical.
- (4) Check if the gasket is attached to the FP correctly.

The upper surface of the gasket should protrude approximately 2mm out from the groove.

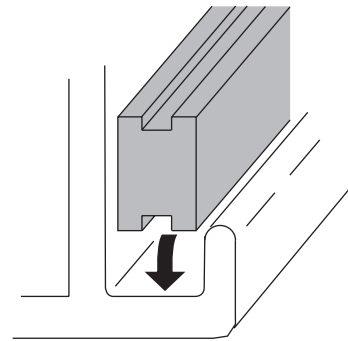

- IMPORTANT** • The gasket must be inserted correctly into the groove for the FP unit's moisture resistance to be equivalent to IP65f.
- Be sure the gasket's seam is not inserted into any of the unit's corners, only in the straight sections of the groove. Inserting it into a corner may lead to its eventually tearing.
  - Install the gasket as it comes to the under side of the display area. Otherwise it could not sufficiently prevent from dust and water.
  - The upper surface of the gasket should protrude approximately 2mm out from the groove. Be sure to check that the gasket is correctly inserted before installing the FP into a panel.

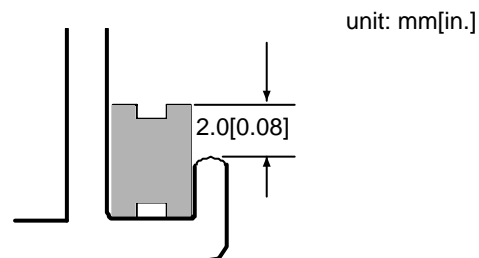

## 7.2 Periodic Check Points

To keep your FP unit in its best condition, please inspect the following points periodically.

### ■FP Operation Environment

- Is the environmental temperature within the allowable range (0°C to 50°C)?
- Is the environmental humidity within the specified range (10%RH to 90%RH, dry bulb temperature of 39°C or less)?
- Is the operating atmosphere free of corrosive gasses?

### ■Electrical Specifications

- Is the Rated Voltage Range appropriate?

FP Model Number	Rated Voltage Range
FP3710-T41-U FP3710-T41	AC85 ~ 264V

### ■Rated Items

- Are all power cords and cables connected properly? Have any become loose?
- Are all installation fasteners holding the unit securely?
- Are there any scratches or traces of dirt on the installation gasket?

## 7.3 Backlight Replacement

The backlight is a cold-cathode tube. Although the FP uses a long-life backlight, replacement may be required earlier than expected depending on the environment where the FP is used. It is recommended that it be replaced periodically.

The life span of the backlight is as follows:

(Time period until the backlight becomes half as bright as a new one) 50,000 hours (approx. 5.7 years)

When a burned-out backlight is detected, the status LED flashes alternately green and red, or a steady orange.

### ⚠ WARNING

- ❗ To prevent an electric shock, be sure to turn the FP unit's power OFF before replacing the backlight.
- ❗ The backlight and the FP itself will be very hot just after turning off the power. To avoid burning your skin, be sure to wear gloves when replacing the backlight.
- ⊘ The backlight is very fragile. To avoid possible injury, do not directly touch the glass or pull the cable.

#### IMPORTANT

- Normally, the FP unit detects a backlight burnout by monitoring the backlight's current flow. However, the FP may fail to detect backlight burnout, or may only detect it before the backlight burns out completely, depending on the type of backlight problem.

#### NOTE

- Please check that the replacement backlight is compatible with the FP.

FP Model	Backlight Model
FP3710-T41-U	CA3-BLU15-01
FP3710-T41	

### ■ Backlight Replacement

Follow the procedures given below to replace the FP unit's backlights. Be sure to wear gloves during replacement.

#### IMPORTANT

- Be sure to protect the FP front panel's surface to prevent damage.
  - The units have an upper and a lower backlight. Be sure to replace both.
  - The units have only one backlight.

### 7.3.1 Replacing CA3-BLU15-01

- (1) Turn off the FP unit's power supply. Remove the eight (8) cover attachment screws.

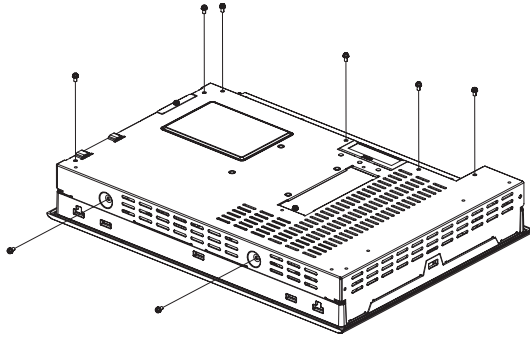

- (2) Remove the FP unit's rear cover.
- (3) Remove the cable from the Inverter Insulation Sheet, and then free the cable from the cable clamp. Next, disconnect the cable connector from the Inverter board's backlight connector.

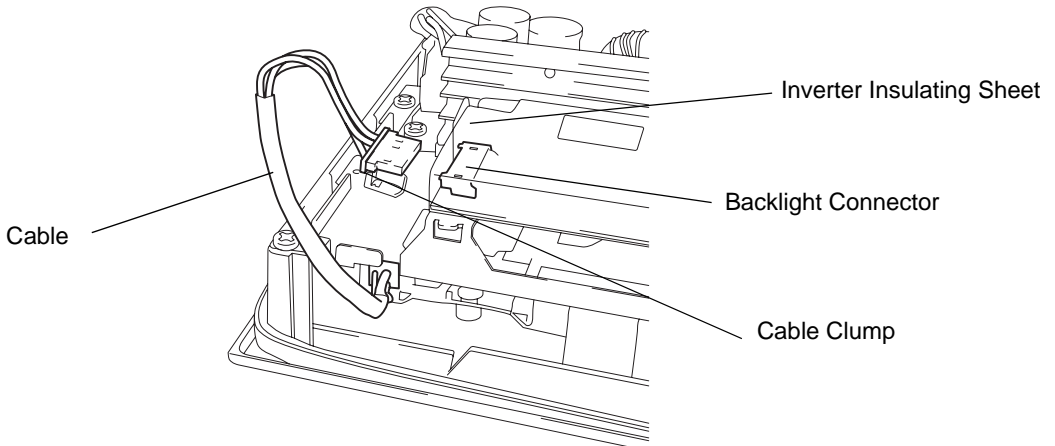

- (4) Insert a screwdriver into the two holes (points) shown below, and remove the backlight attachment screws (1 per hole).

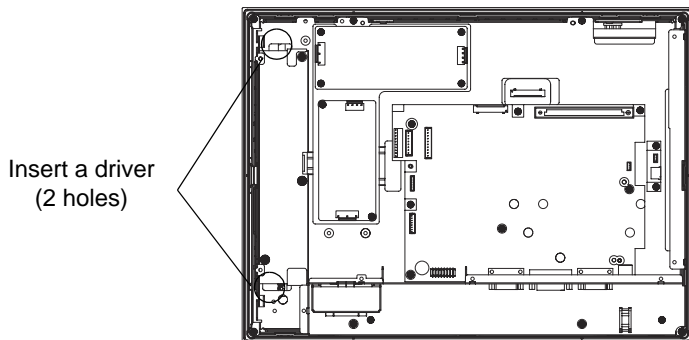

- (5) Pull out the cable in the direction shown by the arrow. The Backlight Unit comes out from the Backlight Unit Insertion Point.

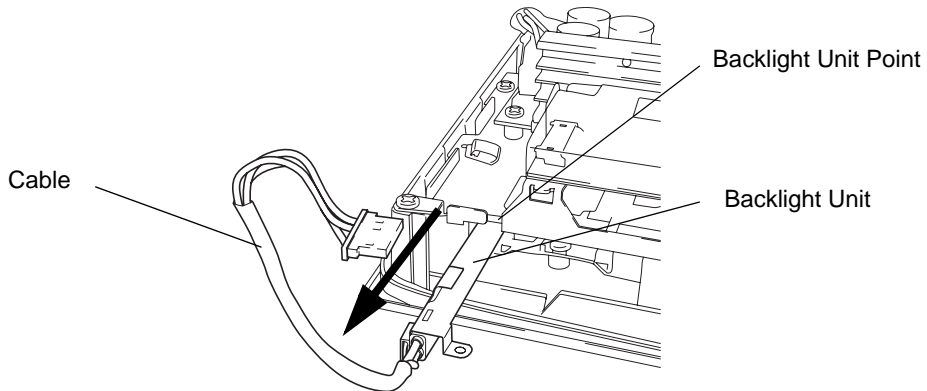

**IMPORTANT** • The entire backlight unit should be changed, not just the backlight.

- (6) Insert the new backlight unit into the backlight holder.
- (7) Secure both backlights in place using the backlight screws. The necessary torque is  $0.147\text{N}\cdot\text{m}$  ( $1.5\text{kgf}\cdot\text{cm}$ ).
- (8) Connect the backlight power cable to the Inverter board's backlight connector.  
Fix the cable in place inside the cable clamp, and cover the cable with the Inverter Insulation Sheet.  
(Reverse of step 3).

**IMPORTANT** • Be sure the cable is inserted completely into the backlight connector. Failure to do so may cause arcing, which can damage the connector.

Be sure to always change both of the FP backlights at the same time.

- (9) Replace the rear cover and secure it in place using the eight (8) attachment screws.

**IMPORTANT** • The cable clamp is used to prevent the cable from being caught inside in the FP unit and possibly damaged. Be sure to secure the cable clamp around the cable before replacing the rear cover.

