

PREFACE

Thank you for purchasing the GP Screen Editor Software, "GP-PRO/PB III for Windows Ver. 6.3" for use with Pro-face's GP series operator interfaces.

Please read this manual carefully in order to use this software properly, and be sure to keep this manual handy for future reference.

NOTES

- (1) The copyrights to all programs and manuals included in the GP-PRO/PB III for Windows Ver. 6.3 (hereinafter referred to as "this product") are reserved by the Digital Electronics Corporation. Digital grants the use of this product to its users as described in the "Software License Agreement" documentation, included with this product's CD-ROM. Any actions violating the above-mentioned conditions are prohibited by both Japanese and foreign regulations.
- (2) The contents of this manual have been thoroughly inspected. However, if you should find any errors or omissions in this manual, please inform your local GP representative of your findings.
- (3) Regardless of article (2), the Digital Electronics Corporation shall not be held responsible for any damages or third party claims resulting from the use of this product.
- (4) Differences may occur between the descriptions found in this manual and the actual functioning of this product. Therefore, the latest information on this product is provided in data files (i.e. Readme.txt files, etc.) and in separate documents. Please consult these sources as well as this manual prior to using the product.
- (5) Even though the information contained in and displayed by this product may be related to intangible or intellectual properties of the Digital Electronics Corporation or third parties, the Digital Electronics Corporation shall not warrant or grant the use of said properties to any users and/or other third parties.
- (6) The specifications set out in this manual are for overseas products only. As a result, some differences may exist between the specifications given here and for those of the identical Japanese product. Digital Electronics Corporation accepts no liability for issues related to the intellectual property rights of third parties or any issues related to the use of the information contained in or displayed by this product.

© Copyright 2003 Digital Electronics Corporation. All rights reserved.
Digital Electronics Corporation, September 2003

For the rights to trademarks and trade names, see "TRADEMARK RIGHTS".

TRADEMARK RIGHTS

All company or product names used in this manual are the trade names, trademarks (including registered trademarks), or service marks of their respective companies.

This product omits individual descriptions of each of these rights.

Trademark / Trade Name	Right Holder
Microsoft, MS, MS-DOS, Windows, Windows 95, Windows 98, Windows Me, Windows NT, Windows 2000, Windows XP, Windows Explorer, Microsoft Excel	Microsoft Corporation, USA
Intel, Pentium	Intel Corporation, USA
Pro-face	Digital Electronics Corporation (in Japan and other countries)
Ethernet	Western Digital Electric Corporation, USA
IBM, VGA, IBM Compatible	International Business Machines Corporation (IBM), USA

The following terms differ from the above mentioned formal trade names and trademarks.

Term used in this manual	Formal Trade Name or Trademark
Windows 95	Microsoft® Windows®95 Operating System
Windows 98	Microsoft® Windows®98 Operating System
Windows Me	Microsoft® Windows®Me Operating System
Windows NT	Microsoft® Windows NT® Operating System
Windows 2000	Microsoft® Windows®2000 Operating System
Windows XP	Microsoft® Windows®XP Operating System
MS-DOS	Microsoft® MS-DOS® Operating System

LIST OF SUPPORTED MODELS

The following table lists the models compatible with GP-PRO/PB III for Windows Ver.6.3. The following series names or product names are used in the descriptions contained in this manual.

■ List of Supported GPs

	Series	Product Name	Model	GP Type		
GP70 series	GP-H70 series	GP-H70L	GPH70-LG11-24V GPH70-LG41-24VP	GPH70L		
		GP-H70S	GPH70-SC11-24V GPH70-SC41-24VP	GPH70S		
	GP-270 series	GP-270L	GP270-LG11-24V	GP270-LG21-24VP	GP270L	
			GP270-LG31-24V			
			GP270-SC11-24V			
	GP-270S	GP-270S	GP270-SC21-24VP	GP270-SC31-24V	GP270S	
	GP-370 series	GP-370L	GP370-LG11-24V	GP370-LG21-24VP	GP370L	
			GP370-LG31-24V	GP370-LG41-24VP		
			GP370-SC11-24V			
		GP-370S	GP-370S	GP370-SC21-24VP	GP370-SC31-24V	GP-370S
	GP-470 series	GP-470E	GP470-EG11	GP470-EG21-24VP	GP470	
				GP470-EG31-24V		
	GP-570 series	GP-570L	GP570-LG11-24V	GP570-LG21-24V	GP570L	
		GP-570S	GP-570S	GP570-SC11	GP570-SC21-24VP	GP570
					GP570-SC31-24V	
				GP570-TC11		
GP-570T		GP-570T	GP570-TC21-24VP	GP570-TC31-24V	GP570	
GP-570VM	GP-570VM	GP570-TV11	GP570VM			
GP-571 series	GP-571T	GP571-TC11	GP571T			
GP-675 series	GP-675S	GP675-SC11	GP675			
	GP-675T	GP675-TC11 GP675-TC41-24VP				
GP-870 series	GP-870VM	GP870-PV11	GP870VM			
GP77 series	GP-377 series	GP-377L	GP377-LG11-24V GP377-LG41-24V	GP377L		
		GP-377S	GP377-SC11-24V GP377-SC41-24V	GP377S		
	GP-37W2 series	GP-37W2B	GP37W2-BG41-24V	GP37W2		
GP77R series	GP-377R series	GP-377RT	GP377R-TC11-24V	GP377R		
			GP377R-TC41-24V			
	GP-477R series	GP-477RE	GP477R-EG11	GP477R		
			GP477R-EG41-24VP			
	GP-577R series	GP-577RS	GP577R-SC11	GP577R		
GP577R-SC41-24VP						
GP577R-TC11						
GP-577RT	GP-577RT	GP577R-TC41-24VP				

LIST OF SUPPORTED MODELS

Series		Product Name	Model	GP Type
GP2000H series	GP-2301H series	GP-2301HL	GP2301H-LG41-24V	GP2301HL
		GP-2301HS	GP2301H-SC41-24V	GP2301HS
	GP-2401H series	GP-2401HT	GP2401H-TC41-24V	GP2401H
GP2000 series	GP-2300 series	GP-2300L	GP2300-LG41-24V	GP2300L
		GP-2300S	GP2300-SC41-24V	GP2300S
		GP-2300T	GP2300-TC41-24V	GP2300
	GP-2301 series	GP-2301L	GP2301-LG41-24V	GP2301L
		GP-2301S	GP2301-SC41-24V	GP2301S
		GP-2301T	GP2301-TC41-24V	GP2301
	GP-2400 series	GP-2400T	GP2400-TC41-24V	GP2400
	GP-2401 Series	GP-2401T	GP2401-TC41-24V	GP2401
	GP-2500 series	GP-2500L	GP2500-LG41-24V	GP2500L
		GP-2500S	GP2500-SC41-24V	GP2500S
		GP-2500T	GP2500-TC11	GP2500
	GP-2501 series	GP-2501L	GP2501-LG41-24V	GP2501L
		GP-2501S	GP2501-SC11	GP2501S
		GP-2501T	GP2501-TC11	GP2501
	GP-2600 series	GP-2600T	GP2600-TC11	GP2600
GP-2601 series	GP-2601T	GP2600-TC41-24V	GP2600	
		GP2601-TC11	GP2601	

■ List of Supported GLCs

Series		Product Name	Model	GP Type
GLC100 series	GLC100 series	GLC100L	GLC100-LG41-24V	GLC100L
		GLC100S	GLC100-SC41-24V	GLC100S
GLC300 series	GLC300 series	GLC300T	GLC300-TC41-24V	GLC300T
GLC2000 series	GLC2300 series	GLC2300L	GLC2300-LG41-24V	GLC2300L
		GLS2300T	GLC2300-TC41-24V	GLC2300
	GLC2400 series	GLC2400T	GLC2400-TC41-24V	GLC2400
	GLC2600 series	GLC2600T	GLC2600-TC41-24V	GLC2600

■ List of Supported STs

Series	Product Name	Model	GP Type
ST400 series	ST400	ST400-AG41-24V	ST400
	ST401	ST401-AG41-24V	ST401
	ST402	ST402-AG41-24V	ST402

■ List of Supported Factory Gateway Units

Product Name	Model	GP Type
Factory Gateway	FGW-SE41-24V	Factory Gateway FGW-SE



Note:

When using the Factory Gateway unit's GP-Web and GP-Viewer features, the GP-PRO/PBIII C-Package02 or higher software is required.

HOW TO USE THIS MANUAL

■ Structure of this Manual

The "Parts List" is the third of four manuals for this product, and explains how to use the "GP-PRO/PB III for Windows Ver. 6.3" software (hereafter referred to as "this product"). Please refer to all of these manuals when using this product. In addition to these manuals, data files containing supplemental information on updated functions are also provided.

To read these files, click on the [Start] button in your Windows OS main screen and select the [Programs]→[Pro-face]→[ProPB3 C-Package] menu. Then click on the [Read Me] selection.

For detailed information about GP series products, please refer to each GP's "UserManual".

Vol. 1	Operation Manual	Describes this product's operation procedures and all standard functions. (provided as PDF data)
Vol. 2	Tag Reference Manual	Describes the functions and detailed settings for all GP-PRO/PBIII Tags. (provided as PDF data)
Vol. 3	Parts List (this manual)	Describes this product's pre-made Parts and symbols. (provided as PDF data)
Vol. 4	Device/PLC Connection Manual	Describes the methods for connecting the GP to other, supported manufacturer Device/PLCs. (provided as PDF data)

The PDF Manual CD-ROM also contains "Screen Data Layout Sheets" in Excel format. To view this data, use your Excel program to open any of the files shown below.

These sheets are useful for designing tag address settings, etc. and example sheets are installed as part of the GP-PRO/PBIII for Windows standard installation. The following two layout sheets, "Device Allocation Table" and "Tag Layout Sheet", are in Microsoft Excel format and are located in the PDF Manual CD-ROM.

The following file location and file names are used.

Folder Name	File Name	Contents
Pro-face\ propbwin\sheet	Device1E.xls	Device Allocation Table
	TAG1E.xls	Tag Layout Sheet
	TAG2E.xls	
	TAG3E.xls	
	TAG4E.xls	

For information on the use of Microsoft Excel, please refer to the Excel software's User Manual.

■ Designation of Supported Models

The functions and settings supported by each model may vary depending on the supported models. In this manual, explanations given are based on the variation of the "Series" and "Product name" described in the "List of Supported Models".

MANUAL SYMBOLS AND TERMINOLOGY





This manual uses the following symbols and terminology.

If you have any questions about the contents of this manual, please contact your local GP distributor.

Also, If you have any question about your personal computer or Windows, please contact your PC distributor or manufacturer.







■ Safety Symbols and Terms

This manual uses the following symbols and terms to identify important information related to the correct and safe operation of this product.

Symbol	Description
 <i>Warning</i>	Indicates a potentially hazardous situation that could result in serious injury or death.
 <i>Caution</i>	Indicates a potentially hazardous situation that could result in minor injury or equipment damage.
 <i>Important</i>	Indicates a potentially damaging action or dangerous situation that could result in abnormal equipment operation or data loss.
 <i>Careful!</i>	Indicates instructions or procedures that must be performed to ensure correct product use.
	Indicates instructions or procedures that must not be performed.

■ General Information Symbols and Terms

This manual uses the following symbols and terms for general information.

Symbol	Description
 <i>Note:</i>	Provides hints on correct product use, or supplementary information.
 <i>Reference</i>	Indicates an item's related information (manual name, page number).
 	Refers to keys on the computer keyboard.  Keyboard Compatibility List
Windows® Compatible	Indicates a PC that can run the Windows® operating system.
Device/PLC	Abbreviation for Device or Programmable Logic Controller. Includes programmable logic controllers and sequencers.
GP	Generic name for the "GP Series" of programmable operator interface made by the Digital Electronics Corporation. For a list of compatible GP products please see "Compatible Products and Environmental Specifications".  LIST OF SUPPORTED MODELS ■ <i>List of Supported GPs</i>
GLC	Generic name for the "GLC Series" of Graphic Logic Controllers made by Digital Electronic Corporation.  LIST OF SUPPORTED MODELS ■ <i>List of Supported GLCs</i>

WHEN USING GLC2000 SERIES UNITS

GLC2000 Series units are equipped with the same features as GP2000 units, with the addition of control-related features. As a result, please change the word “GP” to “GLC” when reading this manual. However, please remember that GLC Series units cannot use AUX output or Sound output.

Be sure to understand this manual thoroughly before using your GLC unit.

WHEN USING ST SERIES UNITS

In this manual, read the word “GP” (“GP2301L”) as “ST”. However, ST units have certain restrictions owing to hardware specification differences with GP-2301L units. Be sure to understand this manual thoroughly before using your ST unit. Functions incompatible with your ST unit, **▼Reference▲** *Operation Manual [GENERAL GP RESTRICTIONS] section, Operation Manual 2.11.2 Restrictions*

TABLE OF CONTENTS

Preface	1
Trademark Rights	2
List of Supported Models	3
How to Use This Manual	5
Manual Symbols and Terminology	6
WHEN USING GLC2000 SERIES UNITS	7
WHEN USING ST SERIES UNITS	7
Table of Contents	8

Chapter 1 Parts List Manual

1.1 Description of the Parts List Manual	1-1
1.2 Parts File Structure	1-1
1.3 How to Read the Function Table	1-5
1.3.1 Items of the Function Table	1-5

Chapter 2 Switch (Bit/Word/Function)

2.1 Switch 3D Parts01	2-1
2.2 Switch 3D Parts02	2-2
2.3 Switch Plain Parts01	2-4
2.4 Switch Plain Parts02	2-5
2.5 Switch Labeled Parts01 Color	2-7
2.6 Switch Labeled Parts01 Monochrome	2-9
2.7 Switch Standard Parts01	2-11
2.8 Switch Image Parts	2-13

Chapter 3 Toggle Switches

3.1	Switch 3D Parts01	3-1
3.2	Switch 3D Parts02	3-2
3.3	Switch Plain Parts01	3-3
3.4	Switch Plain Parts02	3-5
3.5	Switch Standard Parts01	3-6

Chapter 4 Lamps

4.1	Lamp 3D Parts01	4-1
4.2	Lamp 3D Parts02	4-3
4.3	Lamp Plain Parts01	4-4
4.4	Lamp Plain Parts02	4-6
4.5	Lamp Labeled Parts01 Color	4-7
4.6	Lamp Labeled Parts01 Monochrome	4-9
4.7	Lamp Conveyor Parts01 Color	4-11
4.8	Lamp Conveyor Parts01 Monochrome	4-12
4.9	Lamp Ladder Parts01 Color	4-13
4.10	Lamp Ladder Parts01 Monochrome	4-14
4.11	Lamp Water Pipe Parts01 Color	4-15
4.12	Lamp Water Pipe Parts01 Monochrome	4-17
4.13	Lamp Standard Parts01	4-19
4.14	Lamp Image Parts	4-20

Chapter 5 Bar Graphs

5.1	Bar Graph 3D Parts01	5-1
5.2	Bar Graph Plain Parts01	5-2
5.3	Bar Graph Water Pipe Parts01 Color	5-3

Chapter 6 Pie Graphs

6.1	Pie Graph 3D Parts01	6-1
6.2	Pie Graph Plain Parts01	6-2

Chapter 7 Half Pie Graphs

7.1	Half Pie Graph 3D Parts01	7-1
7.2	Half Pie Graph Plain Parts01	7-2

Chapter 8 Tank Graphs

8.1	Tank Graph 3D Parts01	8-1
8.2	Tank Graph Plain Parts01	8-3

Chapter 9 Meter Graphs

9.1	Meter Graph 3D Parts01	9-1
9.2	Meter Graph Plain Parts01	9-2

Chapter 10 Trend Graphs

10.1	Trend Graph 3D Parts01	10-1
10.2	Trend Graph Plain Parts01	10-2

Chapter 11 Keypads

11.1	Keypad <Dec> 3D Parts01	11-1
11.2	Keypad <Dec> Plain Parts01	11-2
11.3	Keypad <Hex> 3D Parts01	11-3
11.4	Keypad <Hex> Plain Parts01	11-4
11.5	Keypad <Text> 3D Parts01	11-5
11.6	Keypad <Text> Plain Parts01	11-6

Chapter 12 Keypad Input Displays

12.1	Keypad Display 3D Parts01	12-1
12.2	Keypad Display Plain Parts01	12-2

Chapter 13 Numeric Displays

13.1	Numeric Display 3D Parts01	13-1
13.2	Numeric Display Plain Parts01	13-2

Chapter 14 Message Displays

14.1	Message Display 3D Parts01	14-1
14.2	Message Display Plain Parts01	14-2

Chapter 15 Date Displays

15.1	Date Display 3D Parts01	15-1
15.2	Date Display Plain Parts01	15-2

Chapter 16 Time Displays

16.1	Time Display 3D Parts01	16-1
16.2	Time Display Plain Parts01	16-2

Chapter 17 Libraries

17.1	Library File Contents	17-1
17.2	Library Addresses	17-2
17.3	Address Setup	17-3
17.4	3-state Switches Data Input Equipment	17-4
17.5	Rotary Switches Data Input Equipment	17-6
17.6	Slide Switches Data Input Equipment	17-9
17.7	Selector Switches Data Input Equipment.....	17-12

17.8	Digital Switches Data Input Equipment	17-15
17.9	Digital Switches2 Data Input Equipment2	17-17
17.10	Volume Switches Data Input Equipment	17-21
17.11	Numeric Input Keypad Data Input Equipment	17-23
17.12	LED Lamps Monitor Equipment Library Parts	17-25
17.13	I/O Monitor Monitor Equipment Library Parts	17-26
17.14	Device Monitor Monitor Equipment Library Parts	17-28
17.15	Timers Multifunction Equipment Library Parts	17-30
17.16	Counter Multifunction Equipment Library Parts	17-32
17.17	Heat Control Multifunction Equipment Library Parts	17-34
17.18	Add/Subtract Momentary Switch Application Library	17-37
17.19	Window Display Tool Application Library	17-39
17.20	2 Button Safety Switch Application Library	17-41
17.21	Alarm Display #1 Application Library	17-43
17.22	Alarm Display #2 Application Library	17-44
17.23	Alarm Display #3 Application Library	17-45
17.24	Active Image Display Tool Application Library	17-46
17.25	Filing Data Edit Tool Application Library	17-47
17.26	Logging Keypad-Decimal Application Library	17-49
17.27	Logging Keypad-Hex Application Library	17-50

Chapter 18 Mark Libraries

18.1	What is the Mark Library	18-1
18.2	Configuration of the MRK File	18-1
18.3	Reading the Mark List	18-2
18.4	Symbol No.s 0001-0050	18-3
18.5	Symbol No.s 0051-0100	18-5

18.6	Symbol No.s 0101-0150	18-7
18.7	Symbol No.s 0151-0200	18-9
18.8	Symbol No.s 0201-0250	18-11
18.9	Symbol No.s 0251-0300	18-13
18.10	Symbol No.s 0301-0350	18-15
18.11	Symbol No.s 0351-0400	18-17
18.12	Symbol No.s 0401-0450	18-19
18.13	Symbol No.s 0451-0500	18-21
18.14	Symbol No.s 0501-0550	18-23
18.15	Symbol No.s 0551-0600	18-25
18.16	Symbol No.s 0601-0650	18-27
18.17	Symbol No.s 0651-0700	18-29
18.18	Symbol No.s 0701-0750	18-31
18.19	Symbol No.s 0751-0800	18-33
18.20	Symbol No.s 0801-0850	18-35
18.21	Symbol No.s 0851-0900	18-37
18.22	Symbol No.s 0901-0950	18-39
18.23	Symbol No.s 0951-1000	18-41
18.24	Symbol No.s 1001-1050	18-43
18.25	Symbol No.s 1051-1100	18-45
18.26	Symbol No.s 1101-1140	18-47

Template Appendix

A.1	Switch 3D Template Switch Parts	Appendix-1
A.2	Switch Plain Template Switch Parts	Appendix-3
A.3	Lamp 3D Template Lamp Parts	Appendix-5
A.4	Lamp Plain Template Lamp Parts	Appendix-7

TABLE OF CONTENTS

A.5 Display Template Display Parts Appendix-9
A.6 Keypad 3D Template Keypad Parts Appendix-10
A.7 Keypad Plain Template Keypad PartsAppendix-11
A.8 Backgrounds Template Screen Background Parts..... Appendix-12

1 Parts List Manual

- 1 Description of the Parts List Manual
- 2 Parts File Structure
- 3 How to Read the Function Table

1.1 Description of the Parts List Manual

This Parts List Manual contains information about pre-made parts and their features such as switches and lamps, for "GP-PRO/PBIII for Windows". These parts are shown in tables for easy identification.







Reference Refer to the "Operation Manual".

1.2 Parts File Structure

Individual Parts Files are organized by type such as Switches and Lamps. The parts shapes are registered mainly in PDB files. Refer to the following table for the contents of each PDB file. In addition to PDB files, BPD files are also available with the GP2000 series. The Image Parts are registered in the BPD files.

Reference For details on the Image Parts, refer to 2.8 Switch Image Parts and 4.14 Lamp Image Parts.













	Parts			GP display type	Parts file		
	Icon	Pull down menu	Type		File name	Title	
P a r t s		Bit Switch	1 point	Color/ monochrome	OP4-3D01.PDB	3D Parts01	
					OP4-3D02.PDB	3D Parts02	
					OP4-PL01.PDB	Plain Parts01	
					OP4-PL02.PDB	Plain Parts02	
					OP4-SP01.PDB	Standard Parts01	
			Label	OP4-MC01.PDB	Labeled Parts01 Color		
				OP4-MM01.PDB	Labeled Parts01 Monochrome		
				1 point	Color/ monochrome	OP4-3D01.PDB	3D Parts01
						OP4-3D02.PDB	3D Parts02
						OP4-PL01.PDB	Plain Parts01
OP4-PL02.PDB	Plain Parts02						
OP4-SP01.PDB	Standard Parts01						
Label	OP4-MC01.PDB	Labeled Parts01 Color					
	OP4-MM01.PDB	Labeled Parts01 Monochrome					

	Parts			GP display type	Parts file	
	Icon	Pull down menu	Type		File name	Title
P a r t s		Function Switch	1 point	Color/ monochrome	OP4-3D01.PDB	3D Parts01
					OP4-3D02.PDB	3D Parts02
					OP4-PL01.PDB	Plain Parts01
					OP4-PL02.PDB	Plain Parts02
					OP4-SP01.PDB	Standard Parts01
			Label	Color	OP4-MC01.PDB	Labeled Parts01 Color
			Monochrome	OP4-MM01.PDB	Labeled Parts01 Monochrome	
		Toggle Switch	1 point	Color/ monochrome	OP4-3D01.PDB	3D Parts01
					OP4-3D02.PDB	3D Parts02
					OP4-PL01.PDB	Plain Parts01
					OP4-PL02.PDB	Plain Parts02
					OP4-SP01.PDB	Standard Parts01
		Lamp	Round/ Square	Color/ monochrome	OP4-3D01.PDB	3D Parts01
					OP4-3D02.PDB	3D Parts02
					OP4-PL01.PDB	Plain Parts01
					OP4-PL02.PDB	Plain Parts02
					OP4-SP01.PDB	Standard Parts01
			Conveyor	Color	OP4-HC01.PDB	Conveyor Parts01 Color
				Monochrome	OP4-HM01.PDB	Conveyor Parts01 Monochrome
			Ladder	Color	OP4-LC01.PDB	Ladder Parts01 Color
				Monochrome	OP4-LM01.PDB	Ladder Parts01 Monochrome
				4-State Lamp	Label	Color
	Monochrome	OP4-MM01.PDB				Labeled Parts01 Monochrome
	Water pipe	Color			OP4-SC01.PDB	Water Pipe Parts01 Color
Monochrome		OP4-SM01.PDB			Water Pipe Parts01 Monochrome	
	Bar Graph	---	Color/ monochrome	OP4-3D01.PDB	3D Parts01	
				OP4-PL01.PDB	Plain Parts01	
				OP4-SC01.PDB	Water Pipe Parts01 Color	
	Pie Graph *1	---	Color/ monochrome	OP4-3D01.PDB	3D Parts01	
				OP4-PL01.PDB	Plain Parts01	
	Half Pie Graph *1	---	Color/ monochrome	OP4-3D01.PDB	3D Parts01	
				OP4-PL01.PDB	Plain Parts01	



Note: The GP2000 series allows you to use Image Parts (BPD Files) for Bit/Word/Function Switches and Lamps.

Reference For details on the BPD Files, refer to 2.8 Switch Image Parts and 4.14 Lamp Image Parts.

	Parts			GP display type	Parts file	
	Icon	Pull down menu	Type		File name	Title
P a r t s		Tank Graph *1	---	Color/ monochrome	OP4-3D01.PDB	3D Parts01
					OP4-PL01.PDB	Plain Parts01
		Meter Graph *1	---	Color/ monochrome	OP4-3D01.PDB	3D Parts01
					OP4-PL01.PDB	Plain Parts01
		Trend Graph	---	Color/ monochrome	OP4-3D01.PDB	3D Parts01
					OP4-PL01.PDB	Plain Parts01
		Keypad	---	Color/ monochrome	OP4-3D01.PDB	3D Parts01
					OP4-PL01.PDB	Plain Parts01
		Keypad Input Display	---	Color/ monochrome	OP4-3D01.PDB	3D Parts01
			OP4-PL01.PDB		Plain Parts01	
	Alarm Display	---	---	---	---	
	Filing Data Display *2	---	---	---	---	
	Logging Display *2	---	---	---	---	
	Numeric Display	---	Color/ monochrome	OP4-3D01.PDB	3D Parts01	
				OP4-PL01.PDB	Plain Parts01	
	Message Display	---	Color/ monochrome	OP4-3D01.PDB	3D Parts01	
				OP4-PL01.PDB	Plain Parts01	
	Date Display	---	Color/ monochrome	OP4-3D01.PDB	3D Parts01	
				OP4-PL01.PDB	Plain Parts01	
	Time Display	---	Color/ monochrome	OP4-3D01.PDB	3D Parts01	
				OP4-PL01.PDB	Plain Parts01	

*1 This function cannot be used on the GP-270.

*2 Can only be used with GP2000, GP77R and GP-377 Series .

	Parts			GP display type	Parts file	
	Icon	Pull down menu	Type		File name	Title
L i b r a r y		Call up Library	---	Color/ monochrome	OP4-LIB1.CPW	Data Input Equipment Library Parts
					OP4-LIB2.CPW	Monitor Equipment Library Parts
					OP4-LIB3.CPW	Multifunction Equipment Library Parts
					OP4-LIB4.CPW	Application Library Parts
					OP4-LIB5.CPW	Data Input Equipment Part 2 Library Parts
					OP4-obja.CPW	3D Template Switch Parts
					OP4-objb.CPW	Plain Template Switch Parts
					OP4-objc.CPW	3D Template Lamp Parts
					OP4-objd.CPW	Plain Template Lamp Parts
					OP4-obje.CPW	Template Display Parts
					OP4-objf.CPW	3D Template Keypad Parts
					OP4-objg.CPW	Plain Template Keypad Parts
					OP4-objh.CPW	Template Screen Background Parts

 **Note:** When creating a GP-Web Screen with GP-PRO/PB III for Windows, be sure to use the specific PDB files and CPW files for GP-Web. If the other files are used, the screen will not appear properly on the Internet. Please select the folder below for PDB files and CPW files.

PDB files : \PDB\GPWEBPDB

CPWfiles : \CPW\GPWEBCPW

Please install the GP-Web file from the GP-Web Installation CD-ROM. Note that Image Parts can also be used with the GP-Web.

Reference For details on the BPD Files, refer to 2.8 Switch Image Parts, 4.14 Lamp Image Parts.

1.3 How to Read the Function Table

On the following pages are tables found under the Shape Browser, which describe functions of the shown Parts. How to read the table is explained in this section.

Ex.)

2.1 Switch 3DPart01 OP4-3D01.PDB

Indicates the title of the Parts file

Indicates the Parts file name

	Change State		Color Settings		
	On	Off	Border	ON/OFF	Fixed
SW_3D001	✓	✓	✓		
SW_3D002	✓	✓	✓	✓	
SW_NO_BOR * 1	✓	✓		only ON	

SW_3D012	✓	✓	✓	✓	
----------	---	---	---	---	--

Part numbers are shown on the left side of the table. The Part number is given to each Part and corresponds to the Part number displayed on the Shape Browser. Before using Parts, confirm the functions from the function table.

* 1 The word "BORDER", depending on the size of your P.C.'s screen window, may be shortened.(i.e. to "BOR" or ""BORD")

1.3.1 Items of the Function Table

The following describes the items of the function table. Items marked with check marks can be used.

Change State Indicates the setting of "On" and "Off". If both "On" and "Off" are checked, the function can be used in either case.

Address used Indicates the setting of "bit" and "word".
 If both "bit" and "word" are checked, the function can be used in either case.
 If only the "bit" is checked, the switch operation is limited to the bit set, bit reset, momentary and reverse.

Color Settings	Indicates the setting of the color of "Border", "ON/OFF", "Fixed", "Scale", "Graph", "Pattern", "Graph Area", "Fg", "Bg", "3d" and "Pad Color".
	"Border" The color can be set for the frame part.
	"ON/OFF" The color can be set respectively for ON and OFF states.
	"Fixed" The color cannot be set.
	"Scale" The scale of the color can be set.
	"Graph" The color of the graph can be set.
	"Graph Area" The background color of the graph can be set.
	"Pattern" The pattern of the graph can be set.
	"Fg" The foreground color can be set.
	"Bg" The background color can be set.
	"3d" The object's 3D (shadow) effect can be set.
	"Pad Color" The color of the keypad can be set.
	If both "Border" and "ON/OFF" are checked, the color for both can be set.
Function	Indicates switch operations. If checked, operations can be performed.
	If marked with "bit", one of the settings bit set, bit reset, momentary and reverse can be set.
Direction	Indicates the direction of graph display.



- Note:** • When designating addresses for tags, use the Layout Sheets that are installed to your system in a standard installation. There are two types of Layout Sheets: "Device Assignment Table" and "Tag Layout Sheet".

Data is available in a number of Microsoft Excel 95 format files.

Location of the files:

```
propbwin\sheet\Device1E.xls
\TAG1E.xls
\TAG2E.xls
\TAG3E.xls
\TAG4E.xls
```

Device1E.xls: Device Assignment Sheet

TAG1E.xls to TAG4E.xls: Tag Layout Sheet

For information on how to use Microsoft Excel 95, refer to the manuals supplied with the product.

■ Notes: When using Parts

When State Change Parts (Bit Switches, Toggle Switches, Lamps, Message Displays, Graphic Displays) and graphics are combined, depending on their arrangement, the GP-PRO/PBIII editor display and the one on the GP screen display may differ.

- When you place a graphic within a Part, the display appears on the GP screen and the one appears on the GP-PRO/PBIII software's editor screen will differ.

(Screen Editor)

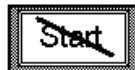

(GP)



- When your graphic extends beyond the Parts, the display that appears on the GP screen will differ from the GP-PRO/PBIII screen.

(Screen Editor)

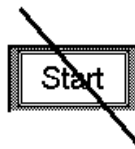

(GP)

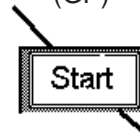

- Do not overlap Parts (except the State Change Parts listed above). If you do, the GP and GP-PRO/PBIII screens will differ.
- Do not overlap Tags and Parts. If you do, the GP and GP-PRO/PBIII screens will differ.
- You can use colors for Lamp-parts titled "***_NO_BORDER", when they are set to "Display ON". In this case, the Part's text characters will be displayed as XOR. When you overlap this Part with a colored graphic, the Part's color will also be displayed as XOR.
- The op4-p102.pdb file's Plain Parts cannot be used with a monochrome GP. Also, when using a color GP, be sure not to set the Bg or Fg to "black" in the ON/OFF color settings area. If it is set to "black", the Part will not appear properly on the GP.
- During aligning of the op4-3d01.pdb and the op4-p101.pdb file Switches and Lamps, if the size of any Part is changed, that Part's sizing handle will not properly align the actual parts. Also, if Parts with a double-lined border are resized, the width of the frame will not scale exactly to the Part's new size.
- Labeled Parts01 can be enlarged or reduced by 2, 4 or 8 times when using switches and lamps. However if the parts are scaled repeatedly, the text may extend off the frame. In this case, you are required to edit the parts again.
op4-mc01.pdb, op4-mm01.pdb, op4-mc01.pdb, op4-mm01.pdb

- When using a 3D Bar, Pie, Half Pie, Tank or Trend Graph or a 3D meter, changing the angle of a Part will cause its shading to move along with the Part. If you wish to maintain the proper angle of shade, you need to select the part again from the Browser.
- The graph areas of the Parts listed below may not be fully filled with paint when the scale reaches 100%. In this case you may need to resize these parts as 1 dot larger or smaller so that the graph fill appears properly.

op4-3d01.pdb	GR_3D007, GR_3D008, GR_3D010, GR_3D015, GR_3D017
op4-pl01.pdb	GR_PL007, GR_PL008, GR_PL010, GR_PL015, GR_PL017

2 Switch (Bit/Word/Function)

High quality 64-color and 256-color Image Parts are also available with the GP2000 series. Monochrome LCD equipped GP2000 series units can use the monochrome (8 shades of grey) image Parts provided.

▼Reference▲ 2.8 Switch Image Parts

2.1 Switch 3D Parts01 OP4-3D01.PDB

SW_3D001	SW_3D002	SW_NO_BOR	SW_3D004	SW_3D005	SW_3D006	SW_3D007	SW_3D008
SW_3D009	SW_3D010	SW_3D011	SW_3D012	SW_3D013	SW_3D014	SW_3D015	SW_3D016
SW_3D017	SW_3D018	SW_3D019					

■ Functions

	Change State		Color Settings				Change State		Color Settings		
	On	Off	Border	ON/OFF	Fixed		On	Off	Border	ON/OFF	Fixed
SW_3D001	✓	✓	✓			SW_3D013	✓	✓		✓	
SW_3D002	✓	✓	✓	✓		SW_3D014	✓	✓			✓
SW_NO_BOR	✓	✓		only ON		SW_3D015	✓	✓			✓
SW_3D004	✓	✓	✓	✓		SW_3D016	✓	✓			✓
SW_3D005	✓	✓	✓	✓		SW_3D017	✓	✓			✓
SW_3D006	✓	✓	✓	✓		SW_3D018	✓	✓		✓	
SW_3D007	✓	✓	✓	✓		SW_3D019	✓	✓			✓
SW_3D008	✓	✓	✓	✓							
SW_3D009*	✓				✓						
SW_3D010	✓	✓		✓							
SW_3D011	✓	✓	✓	only ON							
SW_3D012	✓	✓	✓	✓							

* SW_3D009 cannot be displayed with the word switch or the function switch.

2.2 **Switch** **3D Parts02** OP4-3D02.PDB

SW_3D201	SW_3D202	SW_3D203	SW_3D204	SW_3D205	SW_3D206	SW_3D207	SW_3D208
SW_3D209	SW_3D210	SW_3D211	SW_3D212	SW_3D213	SW_3D214	SW_3D215	SW_3D216
SW_3D217	SW_3D218	SW_3D219	SW_3D220	SW_3D221	SW_3D222	SW_3D223	SW_3D224

■ **Functions**















	Change State		Color Settings				Change State		Color Settings		
	On	Off	Boder	ON/OFF	Fixed		On	Off	Border	ON/OFF	Fixed
SW_3D201	✓	✓	✓			SW_3D213	✓	✓	✓	✓	
SW_3D202	✓	✓	✓	✓		SW_3D214	✓	✓	✓	✓	
SW_3D203	✓	✓	✓	✓		SW_3D215	✓	✓	✓	✓	
SW_3D204	✓	✓	✓	✓		SW_3D216	✓	✓	✓	✓	
SW_3D205	✓	✓	✓	✓		SW_3D217	✓	✓	✓	✓	
SW_3D206	✓	✓	✓	✓		SW_3D218	✓	✓	✓	✓	
SW_3D207	✓	✓	✓	✓		SW_3D219	✓	✓	✓	✓	
SW_3D208	✓	✓	✓	✓		SW_3D220	✓	✓	✓	✓	
SW_3D209	✓	✓	✓	✓		SW_3D221	✓	✓	✓	✓	
SW_3D210	✓	✓	✓	✓		SW_3D222	✓	✓	✓	✓	
SW_3D211	✓	✓	✓	✓		SW_3D223	✓	✓	✓	✓	
SW_3D212	✓	✓	✓	✓		SW_3D224	✓	✓	✓	✓	

2.2

Switch

3D Parts02

OP4-3D02.PDB

SW_3D225	SW_3D226	SW_3D227	SW_3D228	SW_3D229	SW_3D230	SW_3D231	SW_3D232
							
SW_3D233	SW_3D234	SW_3D235	SW_3D236	SW_3D237	SW_3D238	SW_3D239	
							

■ Functions

	Change State		Color Settings				Change State		Color Settings		
	On	Off	Border	ON/OFF	Fixed		On	Off	Border	ON/OFF	Fixed
SW_3D225	✓	✓	✓	✓		SW_3D237	✓	✓			✓
SW_3D226	✓	✓	✓	✓		SW_3D238	✓	✓		✓	
SW_3D227	✓	✓	✓	✓		SW_3D239	✓	✓			✓
SW_3D228	✓	✓	✓								
SW_3D229*	✓		✓								
SW_3D230	✓	✓	✓	✓							
SW_3D231	✓	✓	✓	only ON							
SW_3D232	✓	✓	✓	✓							
SW_3D233	✓	✓	✓								
SW_3D234	✓	✓			✓						
SW_3D235	✓	✓			✓						
SW_3D236	✓	✓			✓						

* SW_3D229 cannot be displayed with the word switch or the function switch.

2.3 **Switch** **Plain Parts01** OP4-PL01.PDB

SW_PL001	SW_PL002	SW_NO_BORDER	SW_PL004	SW_PL005	SW_PL006	SW_PL007	SW_PL008
SW_PL009	SW_PL010	SW_PL011	SW_PL012	SW_PL013	SW_PL014	SW_PL015	SW_PL016
SW_PL017	SW_PL018	SW_PL019	SW_PL020				

■ **Functions**

	Change State		Color Settings				Change State		Color Settings		
	On	Off	Border	ON/OFF	Fixed		On	Off	Border	ON/OFF	Fixed
SW_PL001	✓	✓	✓	✓		SW_PL013 ¹	✓		✓	✓	
SW_PL002	✓	✓	✓	✓		SW_PL014	✓	✓	✓	✓	
SW_NO_BORDER ³	✓	✓	✓	Only ON		SW_PL015	✓	✓	✓	✓	
SW_PL004	✓	✓	✓	✓		SW_PL016 ²	✓	✓	✓	✓	
SW_PL005	✓	✓	✓	✓		SW_PL017 ²	✓	✓	✓	✓	
SW_PL006	✓	✓	✓	✓		SW_PL018 ^{1 2}	✓		✓		
SW_PL007	✓	✓	✓	✓		SW_PL019 ^{1 2}	✓		✓	✓	
SW_PL008	✓	✓	✓	✓		SW_PL020 ^{1 2}	✓		✓	✓	
SW_PL009 ^{1 2}	✓		✓								
SW_PL010 ¹	✓		✓								
SW_PL011 ¹	✓	✓	✓	✓							
SW_PL012	✓	✓	✓	✓							

*1 SW_PL009, SW_PL010, SW_PL011, SW_PL013, SW_PL018, SW_PL019, and SW_PL020 cannot be displayed with the word switch or the function switch.

*2 Be sure not to set the Border color to "black", it will not appear properly on the GP.

*3 "SW_NO_BORDER" can be set for Labels only when they are set to "Display ON". In this case, you are required to consider the color selection, since the text characters are displayed with XOR display. For details on the XOR display, refer to the L-tag section of the Tag Reference Manual.

2.4

Switch

Plain Parts02

OP4-PL02.PDB

SW_PL201	SW_PL202	SW_PL203	SW_PL204	SW_PL205	SW_PL206	SW_PL207	SW_PL208
SW_PL209	SW_PL210	SW_PL211	SW_PL212	SW_PL213	SW_PL214	SW_PL215	SW_PL216
SW_PL217	SW_PL218	SW_PL219	SW_PL220	SW_PL221	SW_PL222	SW_PL223	SW_PL224









■ Functions

	Change State		Color Settings				Change State		Color Settings		
	On	Off	Border	ON/OFF	Fixed		On	Off	Border	ON/OFF	Fixed
SW_PL201	✓	✓	✓	✓		SW_PL213 *1	✓	✓	✓	✓	
SW_PL202 *1	✓	✓	✓	✓		SW_PL214 *1	✓	✓	✓	✓	
SW_PL203 *1	✓	✓	✓	✓		SW_PL215 *1	✓	✓	✓	✓	
SW_PL204 *1	✓	✓	✓	✓		SW_PL216 *1	✓	✓	✓	✓	
SW_PL205 *1	✓	✓	✓	✓		SW_PL217 *1	✓	✓	✓	✓	
SW_PL206 *1	✓	✓	✓	✓		SW_PL218 *1	✓	✓	✓	✓	
SW_PL207 *1	✓	✓	✓	✓		SW_PL219 *1	✓	✓	✓	✓	
SW_PL208 *1	✓	✓	✓	✓		SW_PL220 *1	✓	✓	✓	✓	
SW_PL209 *1	✓	✓	✓	✓		SW_PL221 *1	✓	✓	✓	✓	
SW_PL210 *1	✓	✓	✓	✓		SW_PL222 *1	✓	✓	✓	✓	
SW_PL211 *1	✓	✓	✓	✓		SW_PL223 *1	✓	✓	✓	✓	
SW_PL212 *1	✓	✓	✓	✓		SW_PL224 *1	✓	✓	✓	✓	



*1 These parts cannot be used on a monochrome display GP. When using a color-display GP unit, be sure not to set the Border color and the ON/OFF color settings' Fg/Bg colors to "black". Also, if the Border color is set to "black," it will not appear properly on the GP.

2.4 **Switch** **Plain Parts02** OP4-PL02.PDB

SW_PL225	SW_PL226	SW_PL227	SW_PL228	SW_PL229	SW_PL230	SW_PL231	SW_PL232
							
SW_PL233							
							

■ **Functions**

	Change State		Color Settings				Change State		Color Settings		
	On	Off	Border	ON/OFF	Fixed		On	Off	Border	ON/OFF	Fixed
SW_PL225 *1	✓	✓	✓	✓							
SW_PL226 *1	✓	✓	✓	✓							
SW_PL227 *1	✓	✓	✓	✓							
SW_PL228 *1	✓	✓	✓								
SW_PL229 *2	✓		✓								
SW_PL230 *2	✓		✓								
SW_PL231 *2	✓		✓								
SW_PL232 *2	✓		✓	✓							
SW_PL233 *2	✓		✓	✓							



*1 These parts cannot be used on a monochrome display GP. When using a color display GP, be sure not to set the Border color and the ON/OFF color settings' Fg/Bg colors to "black" . If the Border color is set to "black," it will not appear properly on the GP.

*2 SW-PL229, SW-PL230, SW-PL231, SW-PL232 and SW-PL233 cannot be displayed with the word switch or the function switch.

2.5

Switch Labeled Parts01 Color OP4-MC01.PDB

SW_MC001	SW_MC002	SW_MC003	SW_MC004	SW_MC005	SW_MC006	SW_MC007	SW_MC008
	MENU	MAIN	MONITOR	RUN MONITOR	TROUBLE MONITOR	CONTROL MONITOR	PREVIOUS SCREEN
SW_MC009	SW_MC010	SW_MC011	SW_MC012	SW_MC013	SW_MC014	SW_MC015	SW_MC016
NEXT SCREEN	OPERATOR SCREEN	SETUP SCREEN	ALARM SCREEN	MANUAL SCREEN	AUTO SCREEN	SCREEN 1	SCREEN 2
SW_MC017	SW_MC018	SW_MC019	SW_MC020	SW_MC021	SW_MC022	SW_MC023	SW_MC024
SCREEN 3	PREVIOUS	NEXT	END	SET	RESET	ORIGIN	START

■ **Functions**

	Change State		Color Settings				Change State		Color Settings		
	On	Off	Border	ON/OFF	Fixed		On	Off	Border	ON/OFF	Fixed
SW_MC001	✓	✓		✓		SW_MC013	✓	✓		✓	
SW_MC002	✓	✓		✓		SW_MC014	✓	✓		✓	
SW_MC003	✓	✓		✓		SW_MC015	✓	✓		✓	
SW_MC004	✓	✓		✓		SW_MC016	✓	✓		✓	
SW_MC005	✓	✓		✓		SW_MC017	✓	✓		✓	
SW_MC006	✓	✓		✓		SW_MC018	✓	✓		✓	
SW_MC007	✓	✓		✓		SW_MC019	✓	✓		✓	
SW_MC008	✓	✓		✓		SW_MC020	✓	✓		✓	
SW_MC009	✓	✓		✓		SW_MC021	✓	✓		✓	
SW_MC010	✓	✓		✓		SW_MC022	✓	✓		✓	
SW_MC011	✓	✓		✓		SW_MC023	✓	✓		✓	
SW_MC012	✓	✓		✓		SW_MC024	✓	✓		✓	

2.5 **Switch Labeled Parts01 Color** OP4-MC01.PDB

SW_MC025	SW_MC026	SW_MC027	SW_MC028	SW_MC029	SW_MC030	SW_MC031	SW_MC032
STOP	RAISE	LOWER	MANUAL	AUTO	FORWARD	REVERSE	SETUP
SW_MC033	SW_MC034	SW_MC035	SW_MC036	SW_MC037	SW_MC038	SW_MC039	SW_MC040
DONE	RESET!	OPEN	CLOSE	UP	DOWN	LEFT	RIGHT
SW_MC041	SW_MC042	SW_MC043	SW_MC044	SW_MC045	SW_MC046		
PAGE UP	PAGE DOWN	<--	-->	ON	OFF		

■ **Functions**

	Change State		Color Settings				Change State		Color Settings		
	On	Off	Border	ON/OFF	Fixed		On	Off	Border	ON/OFF	Fixed
SW_MC025	✓	✓		✓		SW_MC037	✓	✓		✓	
SW_MC026	✓	✓		✓		SW_MC038	✓	✓		✓	
SW_MC027	✓	✓		✓		SW_MC039	✓	✓		✓	
SW_MC028	✓	✓		✓		SW_MC040	✓	✓		✓	
SW_MC029	✓	✓		✓		SW_MC041	✓	✓		✓	
SW_MC030	✓	✓		✓		SW_MC042	✓	✓		✓	
SW_MC031	✓	✓		✓		SW_MC043	✓	✓		✓	
SW_MC032	✓	✓		✓		SW_MC044	✓	✓		✓	
SW_MC033	✓	✓		✓		SW_MC045	✓	✓		✓	
SW_MC034	✓	✓		✓		SW_MC046	✓	✓		✓	
SW_MC035	✓	✓		✓							
SW_MC036	✓	✓		✓							

2.6

Switch Labeled Parts01 Monochrome OP4-MM01.PDB

SW_MM001	SW_MM002	SW_MM003	SW_MM004	SW_MM005	SW_MM006	SW_MM007	SW_MM008
	MENU	MAIN	MONITOR	RUN MONITOR	TROUBLE MONITOR	CONTROL MONITOR	PREVIOUS SCREEN
SW_MM009	SW_MM010	SW_MM011	SW_MM012	SW_MM013	SW_MM014	SW_MM015	SW_MM016
NEXT SCREEN	OPERATOR SCREEN	SETUP SCREEN	ALARM SCREEN	MANUAL SCREEN	AUTO SCREEN	SCREEN 1	SCREEN 2
SW_MM017	SW_MM018	SW_MM019	SW_MM020	SW_MM021	SW_MM022	SW_MM023	SW_MM024
SCREEN 3	PREVIOUS	NEXT	END	SET	RESET	ORIGIN	START

■ **Functions**

	Change State		Color Settings				Change State		Color Settings		
	On	Off	Border	ON/OFF	Fixed		On	Off	Border	ON/OFF	Fixed
SW_MM001	✓	✓			✓	SW_MM013	✓	✓			✓
SW_MM002	✓	✓			✓	SW_MM014	✓	✓			✓
SW_MM003	✓	✓			✓	SW_MM015	✓	✓			✓
SW_MM004	✓	✓			✓	SW_MM016	✓	✓			✓
SW_MM005	✓	✓			✓	SW_MM017	✓	✓			✓
SW_MM006	✓	✓			✓	SW_MM018	✓	✓			✓
SW_MM007	✓	✓			✓	SW_MM019	✓	✓			✓
SW_MM008	✓	✓			✓	SW_MM020	✓	✓			✓
SW_MM009	✓	✓			✓	SW_MM021	✓	✓			✓
SW_MM010	✓	✓			✓	SW_MM022	✓	✓			✓
SW_MM011	✓	✓			✓	SW_MM023	✓	✓			✓
SW_MM012	✓	✓			✓	SW_MM024	✓	✓			✓

2.6 **Switch** LabeledParts01 Monochrome OP4-MM01.PDB

SW_MM025	SW_MM026	SW_MM027	SW_MM028	SW_MM029	SW_MM030	SW_MM031	SW_MM032
STOP	RAISE	LOWER	MANUAL	AUTO	FORWARD	REVERSE	SETUP
SW_MM033	SW_MM034	SW_MM035	SW_MM036	SW_MM037	SW_MM038	SW_MM039	SW_MM040
DONE	RESET!	OPEN	CLOSE	UP	DOWN	LEFT	RIGHT
SW_MM041	SW_MM042	SW_MM043	SW_MM044	SW_MM045	SW_MM046		
PAGE UP	PAGE DOWN	<--	-->	ON	OFF		

■ **Functions**

	Change State		Color Settings				Change State		Color Settings		
	On	Off	Border	ON/OFF	Fixed		On	Off	Border	ON/OFF	Fixed
SW_MM025	✓	✓			✓	SW_MM037	✓	✓			✓
SW_MM026	✓	✓			✓	SW_MM038	✓	✓			✓
SW_MM027	✓	✓			✓	SW_MM039	✓	✓			✓
SW_MM028	✓	✓			✓	SW_MM040	✓	✓			✓
SW_MM029	✓	✓			✓	SW_MM041	✓	✓			✓
SW_MM030	✓	✓			✓	SW_MM042	✓	✓			✓
SW_MM031	✓	✓			✓	SW_MM043	✓	✓			✓
SW_MM032	✓	✓			✓	SW_MM044	✓	✓			✓
SW_MM033	✓	✓			✓	SW_MM045	✓	✓			✓
SW_MM034	✓	✓			✓	SW_MM046	✓	✓			✓
SW_MM035	✓	✓			✓						
SW_MM036	✓	✓			✓						

2.7

Switch

Standard Parts01

OP4-SP01.PDB

SW_SP001	SW_SP002	SW_SP003	SW_SP004	SW_SP005	SW_SP006	SW_SP007	SW_SP008
SW_SP009	SW_SP010	SW_SP011	SW_SP012	SW_SP013	SW_SP014	SW_SP015	SW_SP016
SW_SP017	SW_SP018	SW_SP019	SW_SP201	SW_SP202	SW_SP203	SW_SP204	SW_SP205

■ Functions

	Change State		Color Settings				Change State		Color Settings		
	On	Off	Border	ON/OFF	Fixed		On	Off	Border	ON/OFF	Fixed
SW_SP001	✓	✓	✓			SW_SP013	✓	✓	✓	✓	
SW_SP002	✓	✓	✓	✓		SW_SP014	✓	✓	✓	✓	
SW_SP003	✓	✓	✓	✓		SW_SP015	✓	✓	✓	✓	
SW_SP004	✓	✓	✓	✓		SW_SP016	✓	✓	✓	✓	
SW_SP005	✓	✓	✓	✓		SW_SP017	✓	✓	✓	✓	
SW_SP006	✓	✓	✓	✓		SW_SP018	✓	✓	✓	✓	
SW_SP007	✓	✓	✓	✓		SW_SP019	✓	✓	✓	✓	
SW_SP008	✓	✓	✓	✓		SW_SP201	✓	✓	✓	✓	
SW_SP009	✓	✓	✓	✓		SW_SP202	✓	✓	✓	✓	
SW_SP010	✓	✓	✓	✓		SW_SP203	✓	✓	✓	✓	
SW_SP011	✓	✓	✓	✓		SW_SP204	✓	✓	✓	✓	
SW_SP012	✓	✓	✓	✓		SW_SP205	✓	✓	✓	✓	

2.7 Switch Standard Parts01 OP4-SP01.PDB

SW_SP206	SW_SP207	SW_SP208	SW_SP209	SW_SP210	SW_SP211	SW_SP212	SW_SP213
SW_SP214	SW_SP215	SW_SP216	SW_SP217	SW_SP218	SW_SP219	SW_SP220	SW_SP221

■ **Functions**

	Change State		Color Settings				Change State		Color Settings		
	On	Off	Border	ON/OFF	Fixed		On	Off	Border	ON/OFF	Fixed
SW_SP206	✓	✓	✓	✓		SW_SP218	✓	✓	✓	✓	
SW_SP207	✓	✓	✓	✓		SW_SP219	✓	✓	✓	✓	
SW_SP208	✓	✓	✓	✓		SW_SP220	✓	✓	✓	✓	
SW_SP209	✓	✓	✓	✓		SW_SP221	✓	✓		✓	
SW_SP210	✓	✓	✓	✓							
SW_SP211	✓	✓	✓	✓							
SW_SP212	✓	✓	✓	✓							
SW_SP213	✓	✓	✓	✓							
SW_SP214	✓	✓	✓	✓							
SW_SP215	✓	✓	✓	✓							
SW_SP216	✓	✓	✓	✓							
SW_SP217	✓	✓	✓	✓							

2.8

Switch

Image Parts

img_*.BPD

GP2000 series units allow you to use Image Parts for Bit/Word/Function Switches. These Image Parts are available in BPD file format. Toggle Switches cannot use the Image Parts. Image Parts are displayed in 256 colors, 64 colors or monochrome (8 levels of gray). (Only GP2000 series units equipped with monochrome displays can use these colors.) Parts can use any of six colors: white, red, orange, yellow, green, or blue. This section describes the folder configuration and file names of the Image Parts.

■ Folder Contents

Image Parts are located in the PDB folder.

```

\PDB\ImageParts  \img_white256.bpd
                  \img_red256.bpd
                  .
                  .
                  \img_white64.bpd
                  \img_red64.bpd
                  .
                  .
                  \img_grayn.bpd
                  \img_grayr.bpd
    
```

■ File Names

The file name of a BPD file indicates the following:

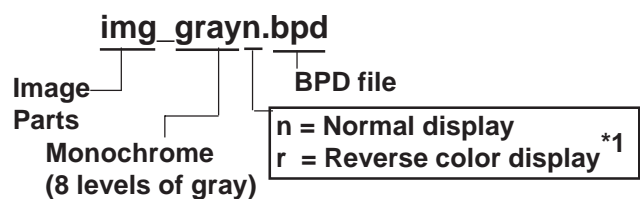
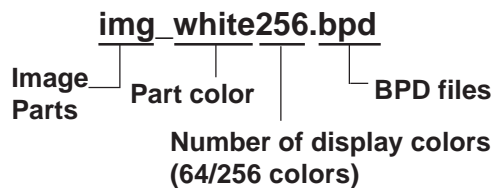

*1 Reverse Display is set via the [System Setup]-> [I/O Settings] tab. Select your BPD parts based on this setting.

■ Part Names

The name of an Image Part indicates the following:

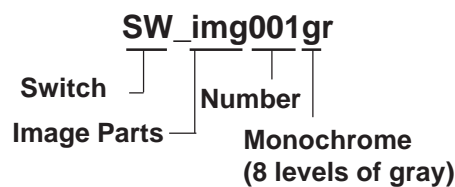
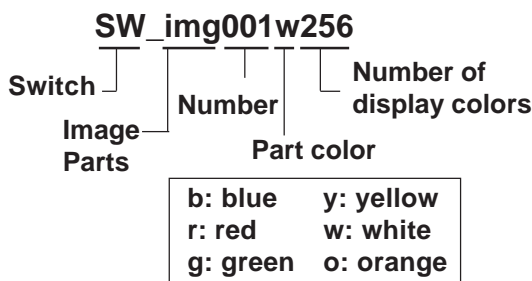

■ Part Functions























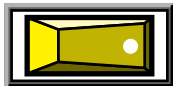















The table below describes the functions of each Part.















Change State		Color Settings		
On	Off	Border	ON/OFF	Fixed
○				○

■ **How to read the Table**

The following section is a table listing each of the parts. Note that the table lists the yellow parts only.

The part shapes are the same for the other colored parts. Please note: however, that the Part Names will be different from the ones listed in the table when using colors other than yellow.

 SW_img001y256 (2KB)	 SW_img002y256 (2KB)	 SW_img003y256 (1KB)	 SW_img004y256 (2KB)
 SW_img005y256 (2KB)	 SW_img006y256 (2KB)	 SW_img007y256 (1KB)	 SW_img008y256 (1KB)
 SW_img009y256 (1KB)	 SW_img010y256 (1KB)	 SW_img011y256 (2KB)	 SW_img012y256 (3KB)
 SW_img013y256 (2KB)	 SW_img014y256 (2KB)	 SW_img015y256 (3KB)	 SW_img016y256 (2KB)
 SW_img017y256 (2KB)	 SW_img018y256 (1KB)	 SW_img019y256 (1KB)	 SW_img020y256 (1KB)
 SW_img021y256 (1KB)	 SW_img022y256 (1KB)	 SW_img023y256 (1KB)	 SW_img024y256 (1KB)
 SW_img025y256 (1KB)	 SW_img026y256 (1KB)	 SW_img027y256 (2KB)	 SW_img028y256 (2KB)
 SW_img029y256 (2KB)	 SW_img030y256 (1KB)	 SW_img031y256 (1KB)	 SW_img032y256 (2KB)
 SW_img033y256 (2KB)	 SW_img034y256 (2KB)	 SW_img035y256 (2KB)	 SW_img036y256 (2KB)
 SW_img037y256 (2KB)	 SW_img038y256 (2KB)	 SW_img039y256 (2KB)	 SW_img040y256 (2KB)

 SW_img041y256 (2KB)	 SW_img042y256 (2KB)	 SW_img043y256 (2KB)	 SW_img044y256 (3KB)
 SW_img045y256 (2KB)	 SW_img046y256 (2KB)	 SW_img047y256 (1KB)	 SW_img048y256 (1KB)
 SW_img049y256 (1KB)	 SW_img050y256 (1KB)	 SW_img051y256 (1KB)	 SW_img052y256 (1KB)
 SW_img053y256 (2KB)	 SW_img054y256 (2KB)		



Note: The sizes given here are for an Image Part. After you select a Part, you can then select an Image Part from that Part's library. If the same Image Part is selected and used repeatedly in a single screen, the total amount of memory used for that Image Part will remain at the amount used by a single Image Part, i.e. if three 2KB Image Parts are placed on a single screen, only 2KB of GP memory will be used.

MEMO

3 Toggle Switches

3.1 Switch 3D Parts01 OP4-3D01.PDB

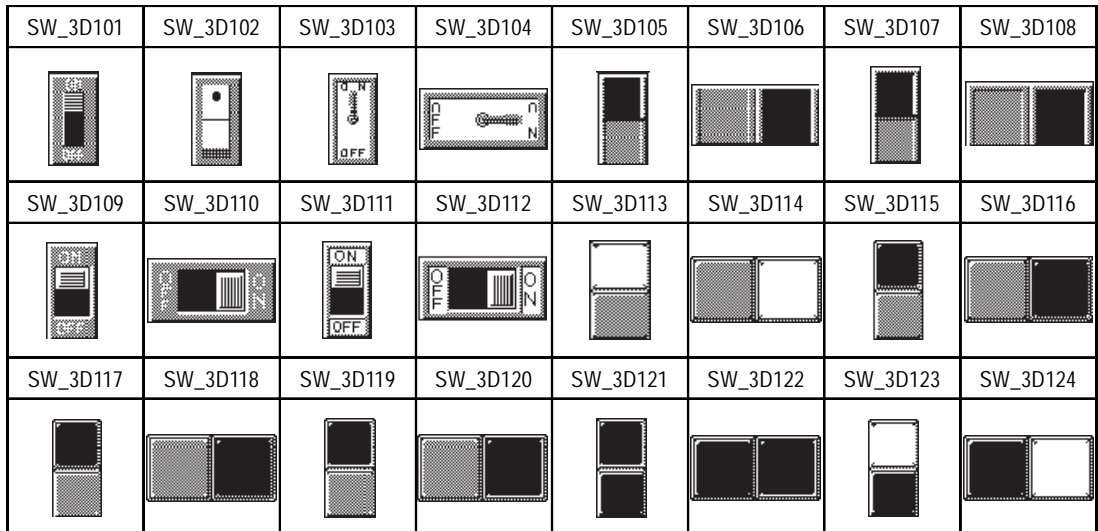

■ Functions

	Change State		Color Settings				Change State		Color Settings		
	On	Off	Border	ON/OFF	Fixed		On	Off	Border	ON/OFF	Fixed
SW_3D101	✓		✓			SW_3D113	✓				✓
SW_3D102	✓		✓			SW_3D114	✓				✓
SW_3D103	✓		✓			SW_3D115	✓				✓
SW_3D104	✓		✓			SW_3D116	✓				✓
SW_3D105	✓		✓	✓		SW_3D117	✓				✓
SW_3D106	✓		✓	✓		SW_3D118	✓				✓
SW_3D107	✓		✓	✓		SW_3D119	✓				✓
SW_3D108	✓		✓	✓		SW_3D120	✓				✓
SW_3D109	✓		✓			SW_3D121	✓			✓	
SW_3D110	✓		✓			SW_3D122	✓			✓	
SW_3D111	✓				✓	SW_3D123	✓				✓
SW_3D112	✓				✓	SW_3D124	✓				✓

3.2 **Switch** **3D Parts02** OP4-3D02.PDB

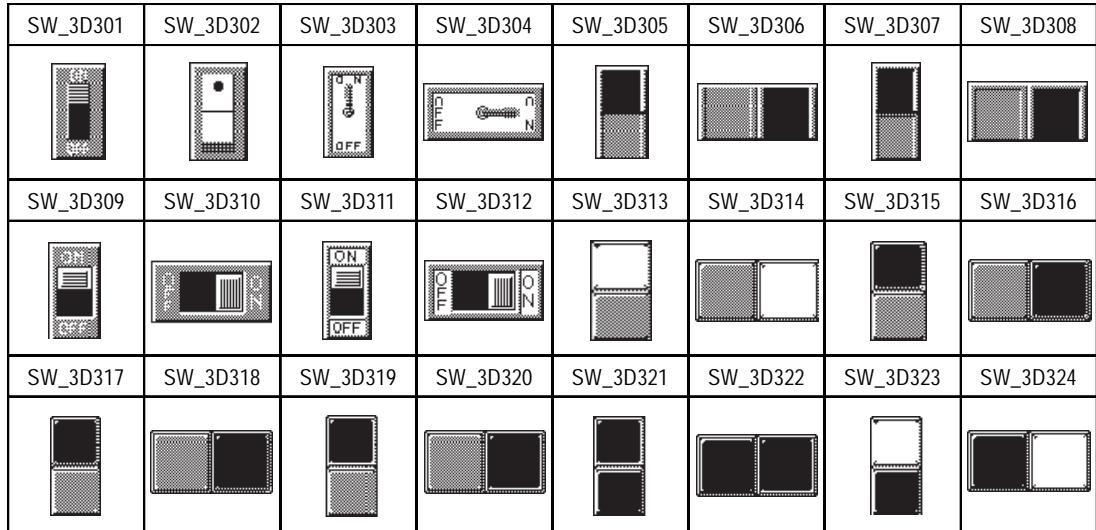

■ **Functions**

	Change State		Color Settings				Change State		Color Settings		
	On	Off	Border	ON/OFF	Fixed		On	Off	Border	ON/OFF	Fixed
SW_3D301	✓		✓			SW_3D313	✓				✓
SW_3D302	✓		✓			SW_3D314	✓				✓
SW_3D303	✓		✓			SW_3D315	✓				✓
SW_3D304	✓		✓			SW_3D316	✓				✓
SW_3D305	✓		✓	✓		SW_3D317	✓				✓
SW_3D306	✓		✓	✓		SW_3D318	✓				✓
SW_3D307	✓		✓	✓		SW_3D319	✓				✓
SW_3D308	✓		✓	✓		SW_3D320	✓				✓
SW_3D309	✓		✓			SW_3D321	✓			✓	
SW_3D310	✓		✓			SW_3D322	✓			✓	
SW_3D311	✓				✓	SW_3D323	✓				✓
SW_3D312	✓				✓	SW_3D324	✓				✓

3.3

Switch

Plain Parts01

OP4-PL01.PDB



SW_PL101	SW_PL102	SW_PL103	SW_PL104	SW_PL105	SW_PL106	SW_PL107	SW_PL108
SW_PL109	SW_PL110	SW_PL111	SW_PL112	SW_PL113	SW_PL114	SW_PL115	SW_PL116
SW_PL117	SW_PL118	SW_PL119	SW_PL120	SW_PL121	SW_PL122	SW_PL123	SW_PL124

■ Functions

	Change State		Color Settings				Change State		Color Settings		
	On	Off	Border	ON/OFF	Fixed		On	Off	Border	ON/OFF	Fixed
SW_PL101	✓		✓			SW_PL113	✓		✓	✓	
SW_PL102 *1	✓		✓			SW_PL114	✓		✓	✓	
SW_PL103	✓		✓			SW_PL115	✓		✓	✓	
SW_PL104	✓		✓			SW_PL116	✓		✓	✓	
SW_PL105	✓		✓			SW_PL117 *1	✓		✓		
SW_PL106	✓		✓			SW_PL118 *1	✓		✓		
SW_PL107	✓		✓			SW_PL119 *1	✓		✓	✓	
SW_PL108	✓		✓			SW_PL120 *1	✓		✓	✓	
SW_PL109	✓		✓	✓		SW_PL121 *1	✓		✓	✓	
SW_PL110	✓		✓	✓		SW_PL122 *1	✓		✓	✓	
SW_PL111	✓		✓	✓		SW_PL123 *1	✓		✓		
SW_PL112	✓		✓	✓		SW_PL124 *1	✓		✓		

*1 Be sure not to set the Border color to "black", it doesn't appear properly on GP.

3.3 **Switch** **Plain Parts01** OP4-PL01.PDB

SW_PL125	SW_PL126						
							

■ **Functions**

	Change State		Color Settings				Change State		Color Settings		
	On	Off	Border	ON/OFF	Fixed		On	Off	Border	ON/OFF	Fixed
SW_PL125	✓		✓	✓							
SW_PL126	✓		✓	✓							

3.4

Switch

Plain Parts02

OP4-PL02.PDB

SW_PL301	SW_PL302	SW_PL303	SW_PL304	SW_PL305	SW_PL306	SW_PL307	SW_PL308
SW_PL309	SW_PL310	SW_PL311	SW_PL312	SW_PL313	SW_PL314	SW_PL315	SW_PL316
SW_PL317	SW_PL318	SW_PL319	SW_PL320				

■ Functions

	Change State		Color Settings				Change State		Color Settings		
	On	Off	Border	ON/OFF	Fixed		On	Off	Border	ON/OFF	Fixed
SW_PL301	✓		✓			SW_PL313	✓		✓	✓	
SW_PL302	✓		✓			SW_PL314	✓		✓	✓	
SW_PL303	✓		✓			SW_PL315	✓		✓	✓	
SW_PL304	✓		✓			SW_PL316	✓		✓	✓	
SW_PL305	✓		✓	✓		SW_PL317	✓		✓		
SW_PL306	✓		✓	✓		SW_PL318	✓		✓		
SW_PL307	✓		✓	✓		SW_PL319	✓		✓	✓	
SW_PL308	✓		✓	✓		SW_PL320	✓		✓	✓	
SW_PL309	✓		✓	✓							
SW_PL310	✓		✓	✓							
SW_PL311	✓		✓								
SW_PL312	✓		✓								

3.5 **Switch** **Standard Parts01** OP4-SP01.PDB

SW_SP101	SW_SP102	SW_SP103	SW_SP104	SW_SP301	SW_SP302	SW_SP303	SW_SP304
SW_SP305	SW_SP306	SW_SP307					

■ **Functions**

	Change State		Color Settings				Change State		Color Settings		
	On	Off	Border	ON/OFF	Fixed		On	Off	Border	ON/OFF	Fixed
SW_SP101	✓		✓								
SW_SP102	✓		✓								
SW_SP103	✓		✓								
SW_SP104	✓		✓								
SW_SP301	✓		✓								
SW_SP302	✓		✓								
SW_SP303	✓		✓	✓							
SW_SP304	✓		✓	✓							
SW_SP305	✓		✓								
SW_SP306	✓		✓								
SW_SP307	✓		✓	✓							

4 Lamps

High quality 64-color and 256-color Image Parts are also available with GP2000 series units. Monochrome LCD equipped GP2000 series units can use the monochrome (8 shades of grey) image Parts provided.

Reference 4.14 Lamp Image Parts

4.1 Lamp 3D Parts01 OP4-3D01.PDB

LM_3D001	LM_3D002	LM_3D003	LM_NO_BOR	LM_3D005	LM_3D006	LM_3D007	LM_3D008
LM_3D009	LM_3D010	LM_3D011	LM_3D012	LM_3D013	LM_3D014	LM_3D015	LM_3D016
LM_3D017	LM_3D018	LM_3D019	LM_3D020	LM_3D021	LM_3D101	LM_3D102	LM_3D103

■ Functions

	Color Settings				Color Settings		
	Border	ON/OFF	Fixed		Border	ON/OFF	Fixed
LM_3D001	✓	✓		LM_3D013*	✓		
LM_3D002	✓	✓		LM_3D014*	✓		
LM_3D003	✓	✓		LM_3D015*	✓		
LM_NO_BOR		only ON		LM_3D016*	✓		
LM_3D005	✓	✓		LM_3D017*	✓		
LM_3D006	✓	✓		LM_3D018*	✓		
LM_3D007*			✓	LM_3D019*	✓		
LM_3D008*			✓	LM_3D020*	✓		
LM_3D009*			✓	LM_3D021*	✓		
LM_3D010*			✓	LM_3D101	✓	✓	
LM_3D011*	✓			LM_3D102	✓	✓	
LM_3D012*	✓			LM_3D103	✓	✓	

*Note that the following Part numbers cannot be used with the monochrome type of the GP. LM_3D007 to LM_3D021

4.1 Lamp **3D Parts01** OP4-3D01.PDB

LM_3D104	LM_3D105	LM_3D106	LM_3D107	LM_3D108	LM_3D109	LM_3D110	LM_3D111
LM_3D112	LM_3D113	LM_3D114	LM_3D115	LM_3D116	LM_3D117	LM_3D118	

■ **Functions**

	Color Settings				Color Settings		
	Border	ON/OFF	Fixed		Border	ON/OFF	Fixed
LM_3D104	✓	✓		LM_3D116	✓	✓	
LM_3D105	✓	✓		LM_3D117	✓	✓	
LM_3D106	✓	✓		LM_3D118	✓	✓	
LM_3D107	✓	✓					
LM_3D108	✓	✓					
LM_3D109	✓	✓					
LM_3D110	✓	✓					
LM_3D111	✓	✓					
LM_3D112	✓	✓					
LM_3D113		✓					
LM_3D114	✓	✓					
LM_3D115	✓	✓					

4.2 **Lamp** **3D Parts02** OP4-3D02.PDB

LM_3D201	LM_3D202	LM_3D203	LM_3D204	LM_3D205	LM_3D301	LM_3D302	LM_3D303
LM_3D304	LM_3D305	LM_3D306	LM_3D307	LM_3D308	LM_3D309	LM_3D310	LM_3D311
LM_3D312	LM_3D313						

■ **Functions**

	Color Settings				Color Settings		
	Border	ON/OFF	Fixed		Border	ON/OFF	Fixed
LM_3D201	✓	✓		LM_3D308	✓	✓	
LM_3D202	✓	✓		LM_3D309	✓	✓	
LM_3D203	✓	✓		LM_3D310	✓	✓	
LM_3D204	✓	✓		LM_3D311	✓	✓	
LM_3D205	✓	✓		LM_3D312	✓	✓	
LM_3D301	✓	✓		LM_3D313	✓	✓	
LM_3D302	✓	✓					
LM_3D303	✓	✓					
LM_3D304	✓	✓					
LM_3D305	✓	✓					
LM_3D306	✓	✓					
LM_3D307	✓	✓					

4.3 **Lamp** **Plain Parts01** OP4-PL01.PDB



















LM_PL001	LM_PL002	LM_PL003	LAMP_NO_BOR	LM_PL005	LM_PL006	LM_PL007	LM_PL008
LM_PL009	LM_PL010	LM_PL011	LM_PL012	LM_PL013	LM_PL014	LM_PL015	LM_PL016
LM_PL017	LM_PL018	LM_PL019	LM_PL020	LM_PL101	LM_PL102	LM_PL103	LM_PL104

■ **Functions**

	Color Settings				Color Settings		
	Border	ON/OFF	Fixed		Border	ON/OFF	Fixed
LM_PL001	✓	✓		LM_PL013	✓	✓	
LM_PL002	✓	✓		LM_PL014	✓	✓	
LM_PL003	✓	✓		LM_PL015	✓	✓	
LM_NO_BORDER*		Only ON		LM_PL016	✓	✓	
LM_PL005	✓	✓		LM_PL017	✓	✓	
LM_PL006	✓	✓		LM_PL018	✓	✓	
LM_PL007	✓	✓		LM_PL019	✓	✓	
LM_PL008	✓	✓		LM_PL020	✓	✓	
LM_PL009	✓	✓		LM_PL101	✓	✓	
LM_PL010	✓	✓		LM_PL102	✓	✓	
LM_PL011	✓	✓		LM_PL103	✓	✓	
LM_PL012	✓	✓		LM_PL104	✓	✓	

* "LM_NO_BORDER" can be set for Labels only when they are set to "Display ON". In this case, you are required to consider the color selection, since the text characters are displayed with XOR display. For details on the XOR display, refer to the L-tag section of the Tag Reference Manual.

4.3 **Lamp** **Plain Parts01** OP4-PL01.PDB

LM_PL105	LM_PL106	LM_PL107	LM_PL108	LM_PL109	LM_PL110	LM_PL111	LM_PL112
							
LM_PL113	LM_PL114	LM_PL115	LM_PL116	LM_PL117	LM_PL118	LM_PL119	LM_PL120
							
LM_PL121	LM_PL122						
							

■ **Functions**

	Color Settings				Color Settings		
	Border	ON/OFF	Fixed		Border	ON/OFF	Fixed
LM_PL105	✓	✓		LM_PL117	✓	✓	
LM_PL106	✓	✓		LM_PL118	✓	✓	
LM_PL107	✓	✓		LM_PL119	✓	✓	
LM_PL108	✓	✓		LM_PL120	✓	✓	
LM_PL109	✓	✓		LM_PL121	✓	✓	
LM_PL110	✓	✓		LM_PL122	✓	✓	
LM_PL111			✓				
LM_PL112			✓				
LM_PL113			✓				
LM_PL114	✓	✓					
LM_PL115	✓	✓					
LM_PL116	✓	✓					

4.4 **Lamp** **Plain Parts02** OP4-PL02.PDB

LM_PL201	LM_PL202	LM_PL203	LM_PL204	LM_PL205	LM_PL206	LM_PL207	LM_PL301
LM_PL302	LM_PL303	LM_PL304	LM_PL305	LM_PL306			

■ **Functions**

	Color Settings				Color Settings		
	Border	ON/OFF	Fixed		Border	ON/OFF	Fixed
LM_PL201	✓	✓		LM_PL306	✓	✓	
LM_PL202	✓	✓					
LM_PL203	✓	✓					
LM_PL204	✓	✓					
LM_PL205	✓	✓					
LM_PL206	✓	✓					
LM_PL207	✓	✓					
LM_PL301	✓	✓					
LM_PL302	✓	✓					
LM_PL303	✓	✓					
LM_PL304	✓	✓					
LM_PL305	✓	✓					

4.5 Lamp Labeled Parts01 Color OP4-MC01.PDB

LM_MC001	LM_MC002	LM_MC003	LM_MC004	LM_MC005	LM_MC006	LM_MC007	LM_MC008
	PROCESS	INJECT	HEAT HANDLING	DRY	RECEIVE	TEST	MOVING
LM_MC009	LM_MC010	LM_MC011	LM_MC012	LM_MC013	LM_MC014	LM_MC015	LM_MC016
RUNNING	STOPPING	>>...	<<...	RISING	DROPPING	MIX	COOLING
LM_MC017	LM_MC018	LM_MC019	LM_MC020	LM_MC021	LM_MC022	LM_MC023	LM_MC024
SEND	ALARM	TROUBLE	ADD WEIGHT	ADD PRESSURE	REDUCE AMOUNT	REDUCE PRESSURE	ADD WATER

■ **Functions**

	Color Setting				Color Settings		
	Border *1	ON/OFF	Fixed		Border *1	ON/OFF	Fixed
LM_MC001	✓	✓		LM_MC013	✓	✓	
LM_MC002	✓	✓		LM_MC014	✓	✓	
LM_MC003	✓	✓		LM_MC015	✓	✓	
LM_MC004	✓	✓		LM_MC016	✓	✓	
LM_MC005	✓	✓		LM_MC017	✓	✓	
LM_MC006	✓	✓		LM_MC018	✓	✓	
LM_MC007	✓	✓		LM_MC019	✓	✓	
LM_MC008	✓	✓		LM_MC020	✓	✓	
LM_MC009	✓	✓		LM_MC021	✓	✓	
LM_MC010	✓	✓		LM_MC022	✓	✓	
LM_MC011	✓	✓		LM_MC023	✓	✓	
LM_MC012	✓	✓		LM_MC024	✓	✓	

*1 The border color is fixed. In this case, character color is set by the border color.

4.5 Lamp Labeled Parts01 Color OP4-MC01.PDB

LM_MC025	LM_MC026	LM_MC027	LM_MC028	LM_MC029	LM_MC030	LM_MC031	LM_MC032
GRIND	ITEM CHECK	MEASURE	ADD HEAT	PURIFY	CHECK	OUT	IN
LM_MC033	LM_MC034	LM_MC035	LM_MC036	LM_MC037	LM_MC038	LM_MC039	LM_MC040
WATER SUPPLY	REMOVE MOISTURE	HUMIDIFY	WASH	RINSE	HIGH PRESSURE	LOW PRESSURE	READ
LM_MC041	LM_MC042	LM_MC043	LM_MC044	LM_MC045	LM_MC046		
WRITE	VALID	VOID	FASTER	SLOWER	TURN		

■ **Functions**

	Color Settings				Color Settings		
	Border *	ON/OFF	Fixed		Border *	ON/OFF	Fixed
LM_MC025	✓	✓		LM_MC037	✓	✓	
LM_MC026	✓	✓		LM_MC038	✓	✓	
LM_MC027	✓	✓		LM_MC039	✓	✓	
LM_MC028	✓	✓		LM_MC040	✓	✓	
LM_MC029	✓	✓		LM_MC041	✓	✓	
LM_MC030	✓	✓		LM_MC042	✓	✓	
LM_MC031	✓	✓		LM_MC043	✓	✓	
LM_MC032	✓	✓		LM_MC044	✓	✓	
LM_MC033	✓	✓		LM_MC045	✓	✓	
LM_MC034	✓	✓		LM_MC046	✓	✓	
LM_MC035	✓	✓					
LM_MC036	✓	✓					

* The border color is fixed. In this case, the character color is set by the border color.

4.6 **Lamp Labeled Parts01 Monochrome** OP4-MM01.PDB

LM_MM001	LM_MM002	LM_MM003	LM_MM004	LM_MM005	LM_MM006	LM_MM007	LM_MM008
	PROCESS	INJECT	HEAT HANDLING	DRY	RECEIVE	TEST	MOVING
LM_MM009	LM_MM010	LM_MM011	LM_MM012	LM_MM013	LM_MM014	LM_MM015	LM_MM016
RUNNING	STOPPING	>>...	<<...	RISING	DROPPING	MIX	COOLING
LM_MM017	LM_MM018	LM_MM019	LM_MM020	LM_MM021	LM_MM022	LM_MM023	LM_MM024
SEND	ALARM	TROUBLE	ADD WEIGHT	ADD PRESSURE	REDUCE AMOUNT	REDUCE PRESSURE	ADD WATER

■ **Functions**

	Color Settings				Color Settings		
	Border	ON/OFF	Fixed		Border	ON/OFF	Fixed
LM_MM001			✓	LM_MM013			✓
LM_MM002			✓	LM_MM014			✓
LM_MM003			✓	LM_MM015			✓
LM_MM004			✓	LM_MM016			✓
LM_MM005			✓	LM_MM017			✓
LM_MM006			✓	LM_MM018			✓
LM_MM007			✓	LM_MM019			✓
LM_MM008			✓	LM_MM020			✓
LM_MM009			✓	LM_MM021			✓
LM_MM010			✓	LM_MM022			✓
LM_MM011			✓	LM_MM023			✓
LM_MM012			✓	LM_MM024			✓

4.6 **Lamp** LabeledParts01 Monochrome OP4-MM01.PDB

LM_MM025	LM_MM026	LM_MM027	LM_MM028	LM_MM029	LM_MM030	LM_MM031	LM_MM032
GRIND	ITEM CHECK	MEASURE	ADD HEAT	PURIFY	CHECK	OUT	IN
LM_MM033	LM_MM034	LM_MM035	LM_MM036	LM_MM037	LM_MM038	LM_MM039	LM_MM040
WATER SUPPLY	REMOVE MOISTURE	HUMIDIFY	WASH	RINSE	HIGH PRESSURE	LOW PRESSURE	READ
LM_MM041	LM_MM042	LM_MM043	LM_MM044	LM_MM045	LM_MM046		
WRITE	VALID	VOID	FASTER	SLOWER	TURN		

■ **Functions**

	Color Settings				Color Settings		
	Border	ON/OFF	Fixed		Border	ON/OFF	Fixed
LM_MM025			✓	LM_MM037			✓
LM_MM026			✓	LM_MM038			✓
LM_MM027			✓	LM_MM039			✓
LM_MM028			✓	LM_MM040			✓
LM_MM029			✓	LM_MM041			✓
LM_MM030			✓	LM_MM042			✓
LM_MM031			✓	LM_MM043			✓
LM_MM032			✓	LM_MM044			✓
LM_MM033			✓	LM_MM045			✓
LM_MM034			✓	LM_MM046			✓
LM_MM035			✓				
LM_MM036			✓				

4.7 **Lamp Conveyor Parts01 Color** OP4-HC01.PDB

LM_HC001	LM_HC002	LM_HC003	LM_HC004	LM_HC005	LM_HC006	LM_HC007	LM_HC008
LM_HC009	LM_HC010	LM_HC011	LM_HC012	LM_HC013			

■ **Functions**

	Color Settings				Color Settings		
	Border	ON/OFF	Fixed		Border	ON/OFF	Fixed
LM_HC001		✓		LM_HC013		✓	
LM_HC002		✓					
LM_HC003		✓					
LM_HC004		✓					
LM_HC005		✓					
LM_HC006		✓					
LM_HC007		✓					
LM_HC008		✓					
LM_HC009		✓					
LM_HC010		✓					
LM_HC011		✓					
LM_HC012		✓					

4.8 **Lamp Conveyor Parts01 Monochrome** OP4-HM01.PDB

LM_HM001	LM_HM002	LM_HM003	LM_HM004	LM_HM005	LM_HM006	LM_HM007	LM_HM008
LM_HM009	LM_HM010	LM_HM011	LM_HM012	LM_HM013			

■ **Functions**

	Color Settings				Color Settings		
	Border	ON/OFF	Fixed		Border	ON/OFF	Fixed
LM_HM001			✓	LM_HM013			✓
LM_HM002			✓				
LM_HM003			✓				
LM_HM004			✓				
LM_HM005			✓				
LM_HM006			✓				
LM_HM007			✓				
LM_HM008			✓				
LM_HM009			✓				
LM_HM010			✓				
LM_HM011			✓				
LM_HM012			✓				

4.9 Lamp Ladder Parts01 Color OP4-LC01.PDB

LM_LC001	LM_LC002	LM_LC003	LM_LC004	LM_LC005	LM_LC006	LM_LC007	LM_LC008
	—	—		— —	— —	●	□

■ **Functions**

	Color Settings				Color Settings		
	Border	ON/OFF	Fixed		Border	ON/OFF	Fixed
LM_LC001		✓					
LM_LC002		✓					
LM_LC003		✓					
LM_LC004		✓					
LM_LC005		✓					
LM_LC006		✓					
LM_LC007		✓					
LM_LC008		✓					

4.10 **Lamp** Ladder Parts01 Monochrome OP4-LM01.PDB

LM_LM001	LM_LM002	LM_LM003	LM_LM004	LM_LM005	LM_LM006	LM_LM007	LM_LM008
	—	—		— —	— —	●	□

■ **Functions**

	Color Setting				Color Settings		
	Border	ON/OFF	Fixed		Border	ON/OFF	Fixed
LM_LM001			✓				
LM_LM002			✓				
LM_LM003			✓				
LM_LM004			✓				
LM_LM005			✓				
LM_LM006			✓				
LM_LM007			✓				
LM_LM008			✓				









4.11 **Lamp** **Water Pipe Parts01 Color** OP4-SC01.PDB

LM_SC001	LM_SC002	LM_SC003	LM_SC004	LM_SC005	LM_SC006	LM_SC007	LM_SC008
LM_SC009	LM_SC010	LM_SC011	LM_SC012	LM_SC013	LM_SC014	LM_SC015	LM_SC016
LM_SC017	LM_SC018	LM_SC019	LM_SC020	LM_SC021	LM_SC022	LM_SC023	LM_SC024

■ **Functions**

	Color Settings				Color Settings		
	Border	ON/OFF	Fixed		Border	ON/OFF	Fixed
LM_SC001	✓	✓		LM_SC013	✓		
LM_SC002	✓	✓		LM_SC014	✓		
LM_SC003	✓	✓		LM_SC015	✓		
LM_SC004	✓	✓		LM_SC016	✓		
LM_SC005	✓	✓		LM_SC017	✓		
LM_SC006	✓	✓		LM_SC018	✓		
LM_SC007	✓	✓		LM_SC019	✓		
LM_SC008	✓	✓		LM_SC020	✓		
LM_SC009	✓	✓		LM_SC021	✓		
LM_SC010	✓	✓		LM_SC022	✓	✓	
LM_SC011	✓	✓		LM_SC023	✓	✓	
LM_SC012	✓	✓		LM_SC024	✓	✓	

4.11 **Lamp** **Water Pipe Parts01 Color** OP4-SC01.PDB

LM_SC025	LM_SC026	LM_SC027	LM_SC028	LM_SC029	LM_SC030	LM_SC031	LM_SC032
							
LM_SC033							
							

■ **Functions**

	Color Settings				Color Settings		
	Border	ON/OFF	Fixed		Border	ON/OFF	Fixed
LM_SC025	✓	✓					
LM_SC026	✓						
LM_SC027	✓	✓					
LM_SC028	✓						
LM_SC029	✓						
LM_SC030	✓						
LM_SC031	✓						
LM_SC032	✓						
LM_SC033	✓						

4.12 **Lamp Water Pipe Parts01 Monochrome** OP4-SM01.PDB

LM_SM001	LM_SM002	LM_SM003	LM_SM004	LM_SM005	LM_SM006	LM_SM007	LM_SM008
LM_SM009	LM_SM010	LM_SM011	LM_SM012	LM_SM013	LM_SM014	LM_SM015	LM_SM016
LM_SM017	LM_SM018	LM_SM019	LM_SM020	LM_SM021	LM_SM022	LM_SM023	LM_SM024

■ **Functions**

	Color Settings				Color Settings		
	Border	ON/OFF	Fixed		Border	ON/OFF	Fixed
LM_SM001			✓	LM_SM013			✓
LM_SM002			✓	LM_SM014			✓
LM_SM003			✓	LM_SM015			✓
LM_SM004			✓	LM_SM016			✓
LM_SM005			✓	LM_SM017			✓
LM_SM006			✓	LM_SM018			✓
LM_SM007			✓	LM_SM019			✓
LM_SM008			✓	LM_SM020			✓
LM_SM009			✓	LM_SM021			✓
LM_SM010			✓	LM_SM022			✓
LM_SM011			✓	LM_SM023			✓
LM_SM012			✓	LM_SM024			✓



















4.12 **Lamp** Water Pipe Parts01 Monochrome OP4-SM01.PDB

LM_SM025	LM_SM026	LM_SM027	LM_SM028	LM_SM029	LM_SM030	LM_SM031	LM_SM032
LM_SM033							

■ **Functions**

	Color Settings				Color Settings		
	Border	ON/OFF	Fixed		Border	ON/OFF	Fixed
LM_SM025			✓				
LM_SM026			✓				
LM_SM027			✓				
LM_SM028			✓				
LM_SM029			✓				
LM_SM030			✓				
LM_SM031			✓				
LM_SM032			✓				
LM_SM033			✓				

4.13 **Lamp** **Standard Parts01** OP4-SP01.PDB

LM_SP001	LM_SP002	LM_SP003	LM_SP004	LM_SP005	LM_SP006	LM_SP007
						
LM_SP008	LM_SP009	LM_SP010	LM_SP011	LM_SP012	LM_SP013	LM_SP014
						
LM_SP015	LM_SP016	LM_SP017	LM_SP018	LM_SP019		
						

■ **Functions**

	Color Settings				Color Settings		
	Border	ON/OFF	Fixed		Border	ON/OFF	Fixed
LM_SP001	✓	✓		LM_SP013			✓
LM_SP002	✓	✓		LM_SP014			✓
LM_SP003	✓	✓		LM_SP015			✓
LM_SP004	✓	✓		LM_SP016			✓
LM_SP005	✓	✓		LM_SP017			✓
LM_SP006	✓	✓		LM_SP018			✓
LM_SP007	✓	✓		LM_SP019		✓	
LM_SP008	✓	✓					
LM_SP009	✓	✓					
LM_SP010	✓	✓					
LM_SP011	✓	✓					
LM_SP012	✓	✓					

4.14 **Lamp** **Image Parts** img_**.BPD

GP2000 series units allow you to use Image Parts for Bit/Word/Function Switches. These Image Parts are available in BPD file format. Toggle Switches cannot use the Image Parts. Image Parts are displayed in 256 colors, 64 colors or monochrome (8 levels of gray). (Only GP2000 series units equipped with monochrome displays can use these colors.) Parts can use any of six colors: white, red, orange, yellow, green, or blue. This section describes the folder configuration and file names of the Image Parts.

■ **Folder Contents**

Image Parts are located in the PDB folder.

```

\PDB\ImageParts  \img_white256.bpd
                  \img_red256.bpd
                  .
                  .
                  \img_white64.bpd
                  \img_red64.bpd
                  .
                  .
                  \img_grayn.bpd
                  \img_grayr.bpd
    
```

■ **File Names**

The file name of a BPD file indicates the following:

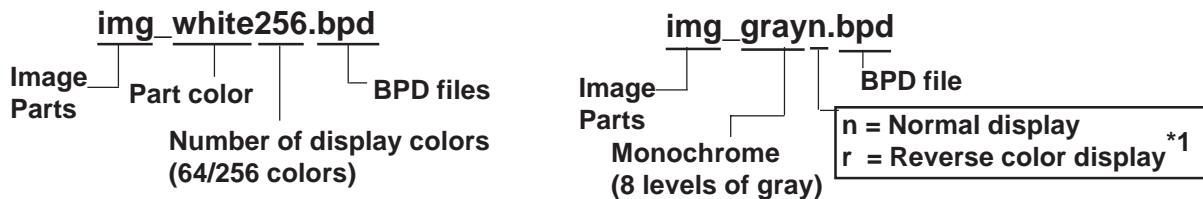

*1 Reverse Display is set via the [System Setup]-> [I/O Settings] tab. Select your BPD parts based on this setting.

■ **Part Names**

The name of an Image Part indicates the following:

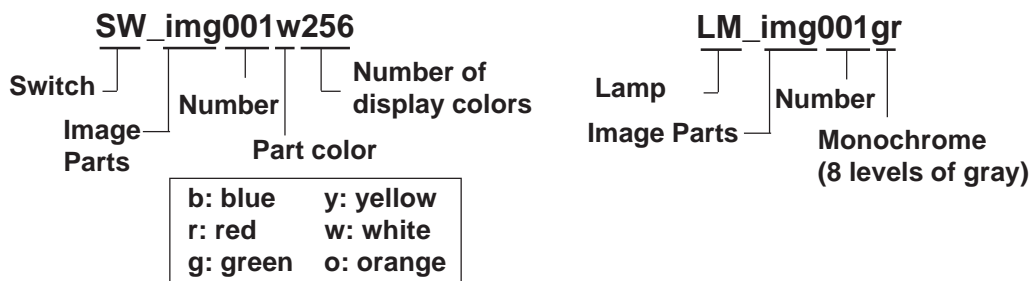

■ **Part Functions**









































The table below describes the functions of each Part.











Color Settings		
Border	ON/OFF	Fixed
		○

■ **How to read the Table**

The following section is a table listing each of the parts. Note that the table lists the yellow parts only.

The part shapes are the same for the other colored parts. Please note: however, that the Part Names will be different from the ones listed in the table when using colors other than yellow.

 LM_img001y256 (2KB)	 LM_img002y256 (2KB)	 LM_img003y256 (1KB)	 LM_img004y256 (2KB)
 LM_img005y256 (2KB)	 LM_img006y256 (2KB)	 LM_img007y256 (1KB)	 LM_img008y256 (2KB)
 LM_img009y256 (1KB)	 LM_img010y256 (2KB)	 LM_img011y256 (1KB)	 LM_img012y256 (2KB)
 LM_img013y256 (3KB)	 LM_img014y256 (2KB)	 LM_img015y256 (2KB)	 LM_img016y256 (2KB)
 LM_img017y256 (1KB)	 LM_img018y256 (2KB)	 LM_img019y256 (2KB)	 LM_img020y256 (3KB)
 LM_img021y256 (2KB)	 LM_img022y256 (2KB)	 LM_img023y256 (2KB)	 LM_img024y256 (3KB)
 LM_img025y256 (2KB)	 LM_img026y256 (2KB)	 LM_img027y256 (2KB)	 LM_img028y256 (2KB)
 LM_img029y256 (2KB)	 LM_img030y256 (3KB)	 LM_img031y256 (2KB)	 LM_img032y256 (2KB)
 LM_img033y256 (2KB)	 LM_img034y256 (2KB)	 LM_img035y256 (3KB)	 LM_img036y256 (2KB)
 LM_img037y256 (2KB)	 LM_img038y256 (2KB)	 LM_img039y256 (2KB)	 LM_img040y256 (1KB)

 LM_img041y256 (1KB)	 LM_img042y256 (1KB)	 LM_img043y256 (1KB)	 LM_img044y256 (1KB)
 LM_img045y256 (1KB)	 LM_img046y256 (1KB)	 LM_img047y256 (2KB)	 LM_img048y256 (2KB)
 LM_img049y256 (2KB)	 LM_img050y256 (2KB)	 LM_img051y256 (2KB)	







 **Note:** The sizes given here are for an Image Part. After you select a Part, you can then select an Image Part from that Part's library. If the same Image Part is selected and used repeatedly in a single screen, the total amount of memory used for that Image Part will remain at the amount used by a single Image Part, i.e. if three 2KB Image Parts are placed on a single screen, only 2KB of GP memory will be used.

5 Bar Graphs

5.1 Bar Graph 3D Parts01 OP4-3D01.PDB

Parts for the bar graph vary depending on the direction. In this case, the display of upward direction is shown.

The character following the part number indicates the graph's orientation.
 BG_3D001U U: Up, D: Down, L: Left, R: Right

BG_3D001U 	BG_3D002U 	BG_3D003U 
BG_3D004U 	BG_3D005U 	BG_3D006U 

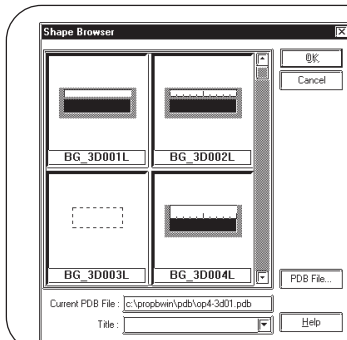

The right direction and the left direction can be displayed. Please verify this on your screen.

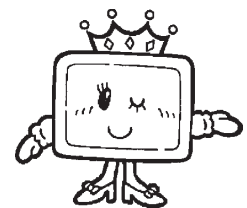

Functions

	Direction				Address used	Color Settings		
	Up	Down	Left	Right		Word	Border	Graph
BG_3D001	✓	✓	✓	✓	✓	✓	✓	✓
BG_3D002	✓	✓	✓	✓	✓	✓	✓	✓
BG_3D003	✓	✓	✓	✓	✓	✓*1	✓	✓
BG_3D004	✓	✓	✓	✓	✓	✓	✓	✓
BG_3D005	✓	✓	✓	✓	✓	✓	✓	✓
BG_3D006	✓	✓	✓	✓	✓	✓	✓	✓

*1 The color of the alarm mark is set by the border color.







Note: Even if the Graph color is set to "dark green" (color no. 255), "black" appears on the GP2000 series with the 256-color settings.

5.2 **Bar Graph** **Plain Parts01** OP4-PL01.PDB

Parts for the bar graph vary depending on the direction. In this case, the display of upward direction is shown.

The character following the part number indicates the graph's orientation.

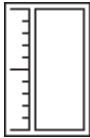
BG_PL001U U: Up, D: Down, L: Left, R: Right

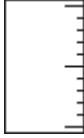
BG_PL001U	BG_PL002U	BG_PL003U
		
BG_PL004U	BG_PL005U	BG_PL006U
		

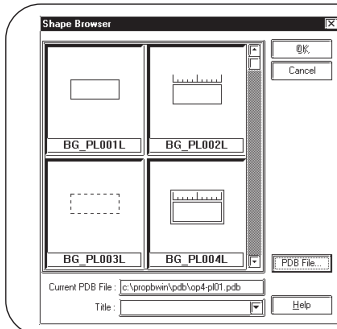

The right direction and the left direction can be displayed. Please verify this on your screen.

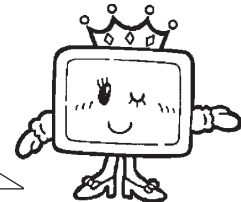

Functions

	Direction				Address used	Color Settings		
	Up	Down	Left	Right		Word	Border	Graph
BG_PL001	✓	✓	✓	✓	✓	✓	✓	✓
BG_PL002	✓	✓	✓	✓	✓	✓	✓	✓
BG_PL003	✓	✓	✓	✓	✓	✓*1	✓	✓
BG_PL004	✓	✓	✓	✓	✓	✓	✓	✓
BG_PL005	✓	✓	✓	✓	✓	✓	✓	✓
BG_PL006	✓	✓	✓	✓	✓	✓	✓	✓

*1 The color of the alarm mark is set by the border color.





Note: Even if the Graph color is set to "dark green" (color no. 255), "black" appears on the GP2000 series with the 256-color settings.

5.3 Bar Graph Water Pipe Parts01 Color OP4-SC01.PDB

Parts for the bar graph vary depending on the direction. In this case, the display of upward direction is shown.

The character following the part number indicates the graph's orientation.

BG_SC001U U: Up, D: Down, L: Left, R: Right

BG_SC001U	BG_SC002U	BG_SC003U
		

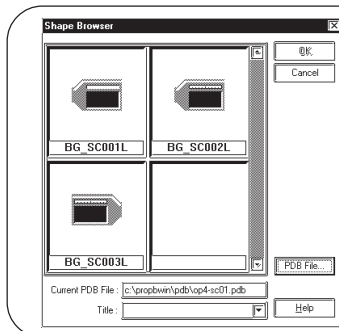

The right direction and the left direction can be displayed. Please verify this on your screen.

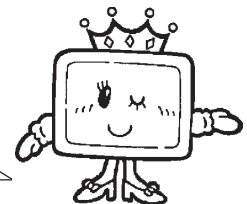

■ Functions

	Direction				Address used	Color Settings	
	Up	Down	Left	Right		Word	Border
BG_SC001	✓	✓	✓	✓	✓	✓	✓
BG_SC002	✓	✓	✓	✓	✓	✓	✓
BG_SC003	✓	✓	✓	✓	✓	✓	✓



Even if the Graph color is set to "dark green" (color no. 255), "black" appears on the GP2000 series with the 256-color settings.

MEMO

6 Pie Graphs

6.1 Pie Graph 3D Parts01 OP4-3D01.PDB

Parts of the pie graph vary depending on the starting point. In this case, the starting point on top is displayed.

The last character of the part number indicates the graph's starting point.

CG_3D001U U: Clockwise from top
 D: Clockwise from bottom

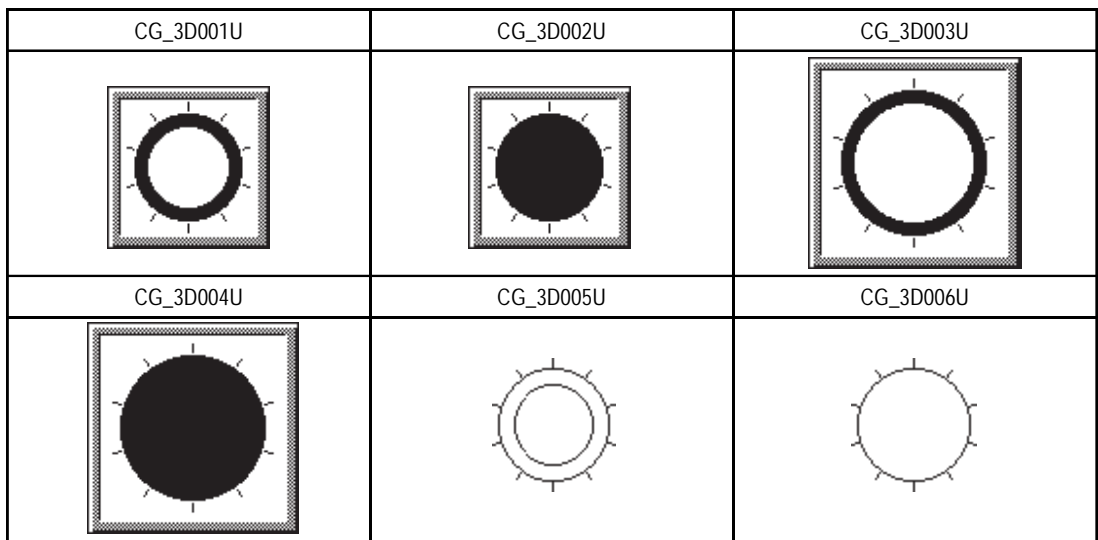

■ Functions

	Direction		Address used	Color Settings			
	From top	From bottom		Word	Border	Scale	Graph
CG_3D001	✓	✓	✓	✓	✓	✓	✓
CG_3D002	✓	✓	✓	✓	✓	✓	✓
CG_3D003	✓	✓	✓	✓	✓	✓	✓
CG_3D004	✓	✓	✓	✓	✓	✓	✓
CG_3D005	✓	✓	✓		✓	✓	✓
CG_3D006	✓	✓	✓		✓	✓	✓

Note: Even if the Graph color is set to "dark green" (color no. 255), "black" appears on the GP2000 series with the 256-color settings.

6.2 Pie Graph Plain Parts01 OP4-PL01.PDB

Parts of the pie graph vary depending on the starting point. In this case, the starting point on top is displayed.

The last character of the part number indicates the graph's starting point.

- CG_PL001U U: Clockwise from top
- D: Clockwise from bottom

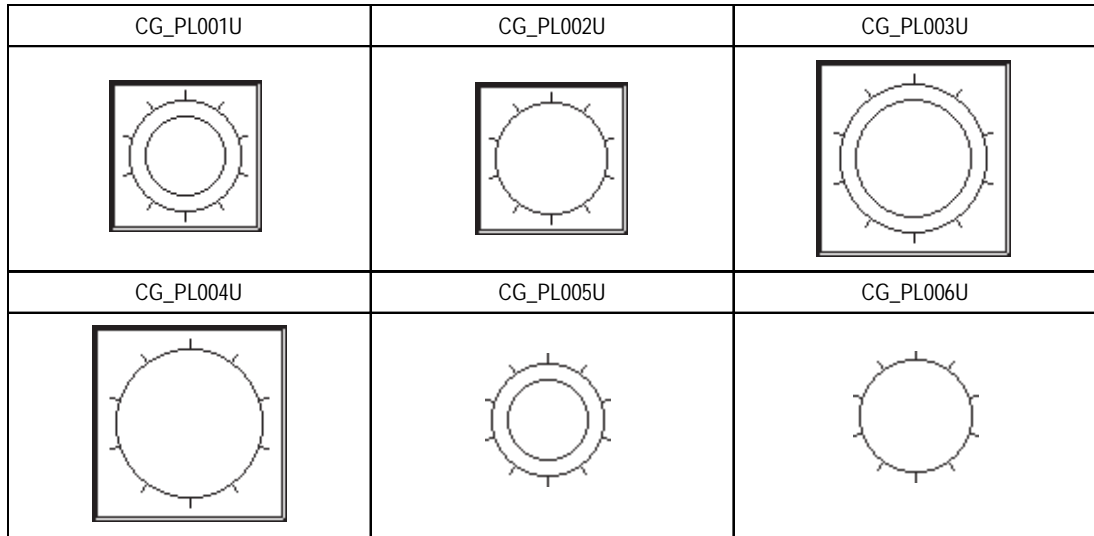

■ **Functions**

	Direction		Address used	Color Settings			
	From top	From bottom	Word	Border	Scale	Graph	Pattern
CG_PL001*1	✓	✓	✓	✓	✓	✓	✓
CG_PL002*1	✓	✓	✓	✓	✓	✓	✓
CG_PL003*1	✓	✓	✓	✓	✓	✓	✓
CG_PL004*1	✓	✓	✓	✓	✓	✓	✓
CG_PL005	✓	✓	✓		✓	✓	✓
CG_PL006	✓	✓	✓		✓	✓	✓



*1 Be sure not to set the Border color to "black", it doesn't appear properly on GP.



Even if the Graph color is set to "dark green" (color no. 255), "black" appears on the GP2000 series with the 256-color settings.

7 Half Pie Graphs

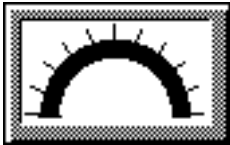
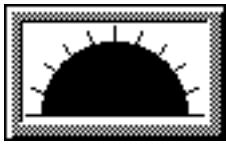
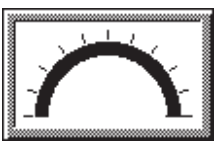
7.1 Half Pie Graph 3D Parts01 OP4-3D01.PDB

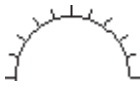





HG_3D001	HG_3D002	HG_3D003
		
HG_3D004	HG_3D005	HG_3D006
		

■ Functions

	Direction		Address used	Color Settings			
	From left	From right		Word	Border	Scale	Graph
HG_3D001	✓		✓	✓	✓	✓	✓
HG_3D002	✓		✓	✓	✓	✓	✓
HG_3D003	✓		✓	✓	✓	✓	✓
HG_3D004	✓		✓	✓	✓	✓	✓
HG_3D005	✓		✓		✓	✓	✓
HG_3D006	✓		✓		✓	✓	✓

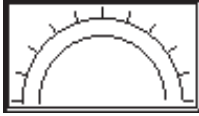
 **Note:** Even if the Graph color is set to "dark green" (color no. 255), "black" appears on the GP2000 series with the 256-color settings.

7.2 Half Pie Graph Plain Parts01 OP4-PL01.PDB

HG_PL001	HG_PL002	HG_PL003
		
HG_PL004	HG_PL005	HG_PL006
		

■ **Functions**

	Direction		Address used	Color Settings			
	From left	From right	Word	Border	Scale	Graph	Pattern
HG_PL001*1	✓		✓	✓	✓	✓	✓
HG_PL002*1	✓		✓	✓	✓	✓	✓
HG_PL003*1	✓		✓	✓	✓	✓	✓
HG_PL004*1	✓		✓	✓	✓	✓	✓
HG_PL005	✓		✓		✓	✓	✓
HG_PL006	✓		✓		✓	✓	✓

*1 Be sure not to set the Border color to "black", it will not appear properly on GP.

 **Note:** Even if the Graph color is set to "dark green" (color no. 255), "black" appears on the GP2000 series with the 256-color settings.

8 Tank Graphs

8.1 Tank Graph 3D Parts01 OP4-3D01.PDB

Tank graph parts can display data in a variety of directions. For example purposes, the following diagram uses a part that display's data in an upwards direction.

The last character of the part number indicates the data's display direction.
 GR_3D001U U: Up, D: Down, L: Left, R: Right

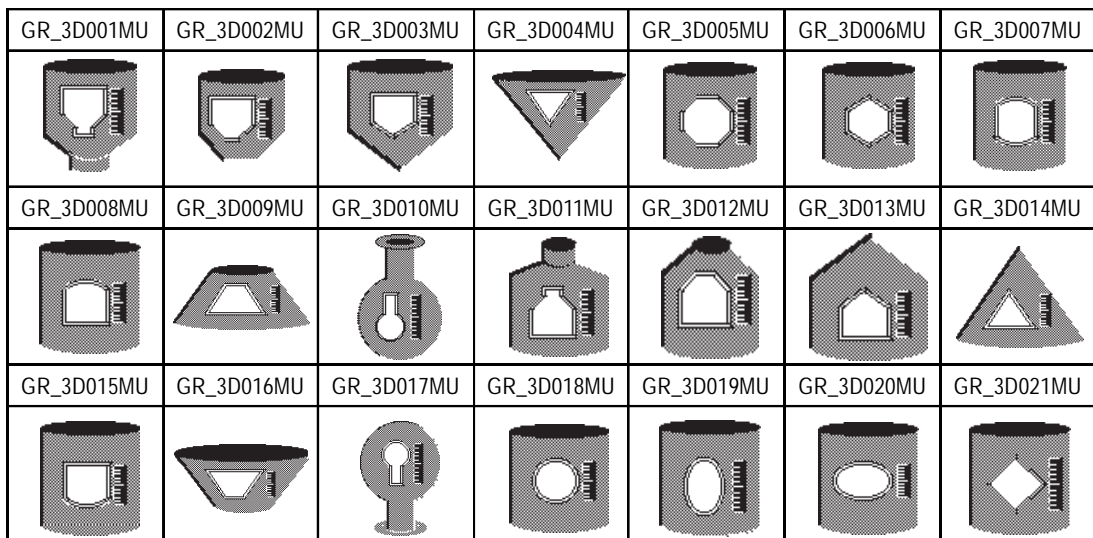

■ Functions

	Direction				Address used Word	Color Settings		
	Up	Down	Left	Right		Border	Graph	Scale
GR_3D001M	✓	✓	✓	✓	✓	✓	✓	✓
GR_3D002M	✓	✓	✓	✓	✓	✓	✓	✓
GR_3D003M	✓	✓	✓	✓	✓	✓	✓	✓
GR_3D004M	✓	✓	✓	✓	✓	✓	✓	✓
GR_3D005M	✓	✓	✓	✓	✓	✓	✓	✓
GR_3D006M	✓	✓	✓	✓	✓	✓	✓	✓
GR_3D007M	✓	✓	✓	✓	✓	✓	✓	✓
GR_3D008M	✓	✓	✓	✓	✓	✓	✓	✓
GR_3D009M	✓	✓	✓	✓	✓	✓	✓	✓
GR_3D010M	✓	✓	✓	✓	✓	✓	✓	✓
GR_3D011M	✓	✓	✓	✓	✓	✓	✓	✓
GR_3D012M	✓	✓	✓	✓	✓	✓	✓	✓
GR_3D013M	✓	✓	✓	✓	✓	✓	✓	✓
GR_3D014M	✓	✓	✓	✓	✓	✓	✓	✓
GR_3D015M	✓	✓	✓	✓	✓	✓	✓	✓
GR_3D016M	✓	✓	✓	✓	✓	✓	✓	✓
GR_3D017M	✓	✓	✓	✓	✓	✓	✓	✓
GR_3D018M	✓	✓	✓	✓	✓	✓	✓	✓
GR_3D019M	✓	✓	✓	✓	✓	✓	✓	✓
GR_3D020M	✓	✓	✓	✓	✓	✓	✓	✓
GR_3D021M	✓	✓	✓	✓	✓	✓	✓	✓



- These parts cannot be used on the GP-270 Series.
- Even if the border color is set to "dark green" (color no.255), "black" appears when using the GP2000 series with the 256-color settings.

8.1 Tank Graph 3D Parts01 OP4-3D01.PDB

GR_3D001U	GR_3D002U	GR_3D003U	GR_3D004U	GR_3D005U	GR_3D006U	GR_3D007U
GR_3D008U	GR_3D009U	GR_3D010U	GR_3D011U	GR_3D012U	GR_3D013U	GR_3D014U
GR_3D015U	GR_3D016U	GR_3D017U	GR_3D018U	GR_3D019U	GR_3D020U	GR_3D021U

Functions

	Direction				Address used Word	Color Settings		
	Up	Down	Left	Right		Border	Graph	Scale
GR_3D001	✓	✓	✓	✓	✓	✓	✓	
GR_3D002	✓	✓	✓	✓	✓	✓	✓	
GR_3D003	✓	✓	✓	✓	✓	✓	✓	
GR_3D004	✓	✓	✓	✓	✓	✓	✓	
GR_3D005	✓	✓	✓	✓	✓	✓	✓	
GR_3D006	✓	✓	✓	✓	✓	✓	✓	
GR_3D007	✓	✓	✓	✓	✓	✓	✓	
GR_3D008	✓	✓	✓	✓	✓	✓	✓	
GR_3D009	✓	✓	✓	✓	✓	✓	✓	
GR_3D010	✓	✓	✓	✓	✓	✓	✓	
GR_3D011	✓	✓	✓	✓	✓	✓	✓	
GR_3D012	✓	✓	✓	✓	✓	✓	✓	
GR_3D013	✓	✓	✓	✓	✓	✓	✓	
GR_3D014	✓	✓	✓	✓	✓	✓	✓	
GR_3D015	✓	✓	✓	✓	✓	✓	✓	
GR_3D016	✓	✓	✓	✓	✓	✓	✓	
GR_3D017	✓	✓	✓	✓	✓	✓	✓	
GR_3D018	✓	✓	✓	✓	✓	✓	✓	
GR_3D019	✓	✓	✓	✓	✓	✓	✓	
GR_3D020	✓	✓	✓	✓	✓	✓	✓	
GR_3D021	✓	✓	✓	✓	✓	✓	✓	



- These parts cannot be used on the GP-270 Series.
- Even if the border color is set to "dark green" (color no.255), "black" appears when using the GP2000 series with the 256-color settings.

8.2

Tank Graph

Plain Parts01

OP4-PL01.PDB

Tank graph parts can display data in a variety of directions. For example purposes, the following diagram uses a part that display's data in an upwards direction.

The last character of the part number indicates the data's display direction.
 GR_3D001U U: Up, D: Down, L: Left, R: Right

GR_PL001MU	GR_PL002MU	GR_PL003MU	GR_PL004MU	GR_PL005MU	GR_PL006MU	GR_PL007MU
GR_PL008MU	GR_PL009MU	GR_PL010MU	GR_PL011MU	GR_PL012MU	GR_PL013MU	GR_PL014MU
GR_PL015MU	GR_PL016MU	GR_PL017MU	GR_PL018MU	GR_PL019MU	GR_PL020MU	GR_PL021MU

■ Functions

	Direction				Address used Word	Color Setting		
	Up	Down	Left	Right		Border	Graph	Scale
GR_PL001M	✓	✓	✓	✓	✓	✓	✓	✓
GR_PL002M	✓	✓	✓	✓	✓	✓	✓	✓
GR_PL003M	✓	✓	✓	✓	✓	✓	✓	✓
GR_PL004M	✓	✓	✓	✓	✓	✓	✓	✓
GR_PL005M	✓	✓	✓	✓	✓	✓	✓	✓
GR_PL006M	✓	✓	✓	✓	✓	✓	✓	✓
GR_PL007M	✓	✓	✓	✓	✓	✓	✓	✓
GR_PL008M	✓	✓	✓	✓	✓	✓	✓	✓
GR_PL009M	✓	✓	✓	✓	✓	✓	✓	✓
GR_PL010M	✓	✓	✓	✓	✓	✓	✓	✓
GR_PL011M	✓	✓	✓	✓	✓	✓	✓	✓
GR_PL012M	✓	✓	✓	✓	✓	✓	✓	✓
GR_PL013M	✓	✓	✓	✓	✓	✓	✓	✓
GR_PL014M	✓	✓	✓	✓	✓	✓	✓	✓
GR_PL015M	✓	✓	✓	✓	✓	✓	✓	✓
GR_PL016M	✓	✓	✓	✓	✓	✓	✓	✓
GR_PL017M	✓	✓	✓	✓	✓	✓	✓	✓
GR_PL018M	✓	✓	✓	✓	✓	✓	✓	✓
GR_PL019M	✓	✓	✓	✓	✓	✓	✓	✓
GR_PL020M	✓	✓	✓	✓	✓	✓	✓	✓
GR_PL021M	✓	✓	✓	✓	✓	✓	✓	✓



- These parts cannot be used on the GP-270 Series.
- Even if the border color is set to "dark green" (color no.255), "black" appears when using the GP2000 series with the 256-color settings.

8.2 Tank Graph Plain Parts01 OP4-PL01.PDB

GR_PL001U	GR_PL002U	GR_PL003U	GR_PL004U	GR_PL005U	GR_PL006U	GR_PL007U
GR_PL008U	GR_PL009U	GR_PL010U	GR_PL011U	GR_PL012U	GR_PL013U	GR_PL014U
GR_PL015U	GR_PL016U	GR_PL017U	GR_PL018U	GR_PL019U	GR_PL020U	GR_PL021U

■ **Functions**

	Direction				Address used	Color Settings		
	Up	Down	Left	Right	Word	Border	Graph	Scale
GR_PL001	✓	✓	✓	✓	✓	✓	✓	
GR_PL002	✓	✓	✓	✓	✓	✓	✓	
GR_PL003	✓	✓	✓	✓	✓	✓	✓	
GR_PL004	✓	✓	✓	✓	✓	✓	✓	
GR_PL005	✓	✓	✓	✓	✓	✓	✓	
GR_PL006	✓	✓	✓	✓	✓	✓	✓	
GR_PL007	✓	✓	✓	✓	✓	✓	✓	
GR_PL008	✓	✓	✓	✓	✓	✓	✓	
GR_PL009	✓	✓	✓	✓	✓	✓	✓	
GR_PL010	✓	✓	✓	✓	✓	✓	✓	
GR_PL011	✓	✓	✓	✓	✓	✓	✓	
GR_PL012	✓	✓	✓	✓	✓	✓	✓	
GR_PL013	✓	✓	✓	✓	✓	✓	✓	
GR_PL014	✓	✓	✓	✓	✓	✓	✓	
GR_PL015	✓	✓	✓	✓	✓	✓	✓	
GR_PL016	✓	✓	✓	✓	✓	✓	✓	
GR_PL017	✓	✓	✓	✓	✓	✓	✓	
GR_PL018	✓	✓	✓	✓	✓	✓	✓	
GR_PL019	✓	✓	✓	✓	✓	✓	✓	
GR_PL020	✓	✓	✓	✓	✓	✓	✓	
GR_PL021	✓	✓	✓	✓	✓	✓	✓	



- These parts cannot be used on the GP-270 Series.
- Even if the border color is set to "dark green" (color no.255), "black" appears when using the GP2000 series with the 256-color settings.

9 Meter Graphs

9.1 Meter Graph 3D Parts01 OP4-3D01.PDB

MT_3D001	MT_3D002	MT_3D003	MT_3D004	MT_3D005	MT_3D006	MT_3D007
MT_3D008	MT_3D009	MT_3D010	MT_3D011	MT_3D012	MT_3D013	MT_3D014
MT_3D015	MT_3D016	MT_3D017	MT_3D018	MT_3D019	MT_3D020	

■ Functions

	Direction		Address used	Color Settings		
	Left	Right		Border	Meter	Scale
MT_3D001	✓	✓	✓	✓	✓	✓
MT_3D002	✓	✓	✓	✓	✓	✓
MT_3D003	✓	✓	✓	✓	✓	✓
MT_3D004	✓	✓	✓	✓	✓	✓
MT_3D005	✓	✓	✓	✓	✓	✓
MT_3D006	✓	✓	✓	✓	✓	✓
MT_3D007	✓	✓	✓	✓	✓	✓
MT_3D008	✓	✓	✓	✓	✓	✓
MT_3D009	✓	✓	✓	✓	✓	✓
MT_3D010	✓	✓	✓	✓	✓	✓
MT_3D011	✓	✓	✓	✓	✓	✓
MT_3D012	✓	✓	✓	✓	✓	✓
MT_3D013	✓	✓	✓	✓	✓	✓
MT_3D014	✓	✓	✓	✓	✓	✓
MT_3D015	✓	✓	✓	✓	✓	✓
MT_3D016	✓	✓	✓	✓	✓	✓
MT_3D017	✓	✓	✓	✓	✓	✓
MT_3D018	✓	✓	✓	✓	✓	✓
MT_3D019	✓	✓	✓	✓	✓	✓
MT_3D020	✓	✓	✓	✓	✓	✓

Note: These parts cannot be used on the GP-270 Series.

9.2 Meter Graph Plain Parts01 OP4-PL01.PDB

MT_PL001	MT_PL002	MT_PL003	MT_PL004	MT_PL005	MT_PL006	MT_PL007
MT_PL008	MT_PL009	MT_PL010	MT_PL011	MT_PL012	MT_PL013	MT_PL014
MT_PL015	MT_PL016	MT_PL017	MT_PL018	MT_PL019	MT_PL020	

■ **Functions**

	Direction		Address used	Color Settings		
	Left	Right	Word	Border	Meter	Scale
MT_PL001	✓	✓	✓		✓	✓
MT_PL002	✓	✓	✓		✓	✓
MT_PL003	✓	✓	✓		✓	✓
MT_PL004	✓	✓	✓		✓	✓
MT_PL005	✓	✓	✓		✓	✓
MT_PL006	✓	✓	✓		✓	✓
MT_PL007	✓	✓	✓		✓	✓
MT_PL008	✓	✓	✓		✓	✓
MT_PL009	✓	✓	✓		✓	✓
MT_PL010	✓	✓	✓		✓	✓
MT_PL011	✓	✓	✓		✓	✓
MT_PL012	✓	✓	✓		✓	✓
MT_PL013	✓	✓	✓		✓	✓
MT_PL014	✓	✓	✓		✓	✓
MT_PL015	✓	✓	✓		✓	✓
MT_PL016	✓	✓	✓		✓	✓
MT_PL017	✓	✓	✓		✓	✓
MT_PL018	✓	✓	✓		✓	✓
MT_PL019	✓	✓	✓		✓	✓
MT_PL020	✓	✓	✓		✓	✓





These parts cannot be used on the GP-270 Series.

10 Trend Graphs

10.1 Trend Graph 3D Parts01 OP4-3D01.PDB

Trend graph parts can display data in a variety of directions. For example purposes, the following diagram uses a part that display's data in an upwards direction.

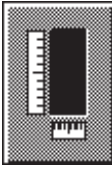
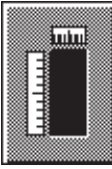
The last character of the part number indicates the data's display direction.
 TR_3D001U U: Up, D: Down, L: Left, R: Right

TR_3D001U	TR_3D002U	TR_3D003U
		

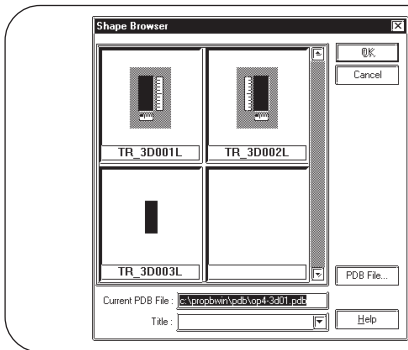

When the graph's direction is downward, right, or left, the positions of the scales will change. Please verify this on your screen.

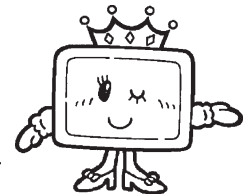

■ Functions

	Direction				Address used	Color Settings		
	Up	Down	Left	Right		Word	Border	Graph area
TR_3D001	✓	✓	✓	✓	✓	✓	✓	✓
TR_3D002	✓	✓	✓	✓	✓	✓	✓	✓
TR_3D003	✓	✓	✓	✓	✓		✓	

10.2 Trend Graph Plain Parts01 OP4-PL01.PDB

Trend graph parts can display data in a variety of directions. For example purposes, the following diagram uses a part that display's data in an upwards direction.

The last character of the part number indicates the data's display direction.
 TR_PL001U U: Up, D: Down, L: Left, R: Right

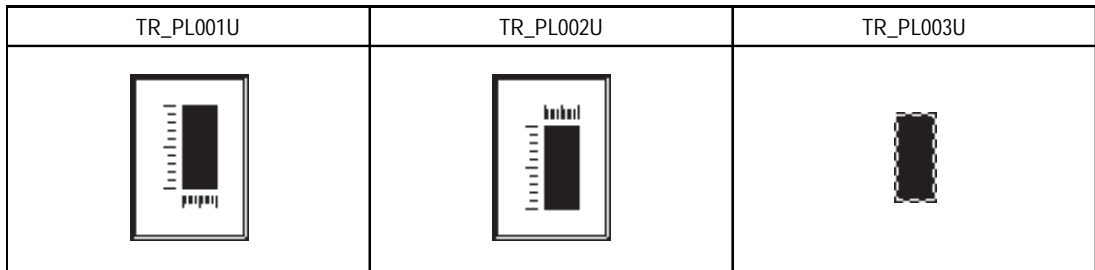

When the graph's direction is downward, right, or left, the positions of the scales will change. Please verify this on your screen.

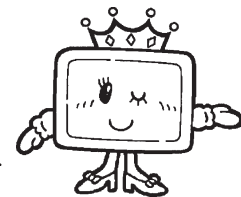

■ **Functions**

	Direction				Address used	Color Settings		
	Up	Down	Left	Right		Word	Border	Graph area
TR_PL001	✓	✓	✓	✓	✓	✓	✓	✓
TR_PL002	✓	✓	✓	✓	✓	✓	✓	✓
TR_PL003	✓	✓	✓	✓	✓		✓	

11 Keypads

11.1 Keypad <Dec> 3D Parts01 OP4-3D01.PDB

Characters following the part number indicate the type of the Keypad.

KP_3D001D D:Dec, H:Hex, T:Text

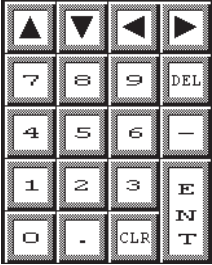
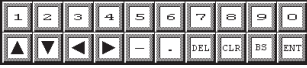
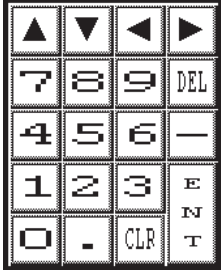
KP_3D001D	KP_3D002D	KP_3D003D
		

■ Functions

	Color Settings
	Pad Color
KP_3D001D	✓
KP_3D002D*1	✓
KP_3D003D*2	✓

*1 The KP_3D002D cannot be used with the GP-270/370/H70 series.

*2 The KP_3D003D is double the size of the KP_3D001D.
The KP_3D003D cannot be used with the GP-270/370/H70 series.

11.2 Keypad <Dec> Plain Parts01 OP4-PL01.PDB

Characters following the part number indicate the type of the Keypad.

KP_PL001D D:Dec, H:Hex, T:Text

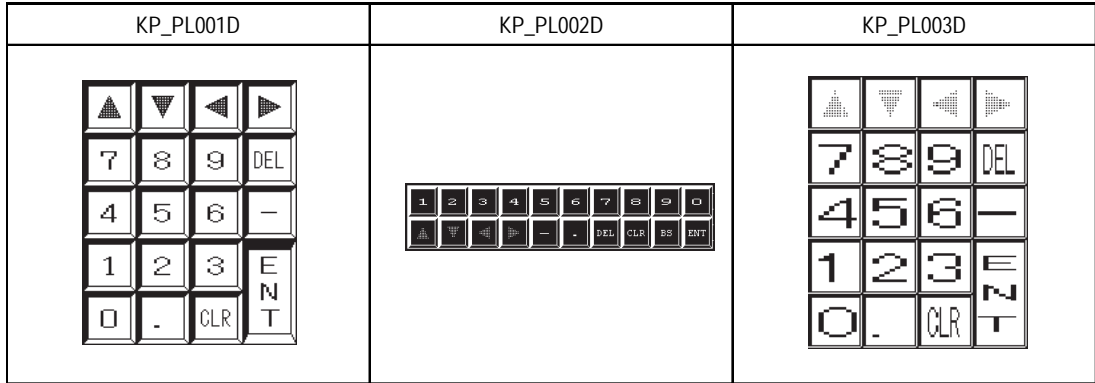

■ **Functions**

	Color Settings
	Pad Color
KP_PL001D	✓
KP_PL002D*1	✓
KP_PL003D*2	✓

*1 The KP_PL002D cannot be used with the GP-270/370/H70 series.

*2 The KP_PL003D is double the size of the KP_PL001D.
 KP_PL003D cannot be used with the GP-270/370/H70 series.

11.3 Keypad <Hex> 3D Parts01 OP4-3D01.PDB

Characters following the part number indicate the type of the Keypad.

KP_3D001H D:Dec, H:Hex, T:Text

KP_3D001H	KP_3D002H	

■ **Functions**

	Color Settings
	Pad Color
KP_3D001H	✓
KP_3D002H*	✓

* The KP_3D002H cannot be used with the GP-270/370/H70 series.

11.4 Keypad <Hex> Plain Parts01 OP4-PL01.PDB

Characters following the part number indicate the type of the Keypad.

KP_PL001H D:Dec, H:Hex, T:Text

KP_PL001H	KP_PL002H	

■ **Functions**

	Color Settings
	Pad Color
KP_PL001H	✓
KP_PL002H*	✓

* The KP_PL002H cannot be used with the GP-270/370/H70 series.

11.5

Keypad <Text>

3D Parts01

OP4-3D01.PDB

Characters following the part number indicate the type of the Keypad.

KP_3D001T D:Dec, H:Hex, T:Text

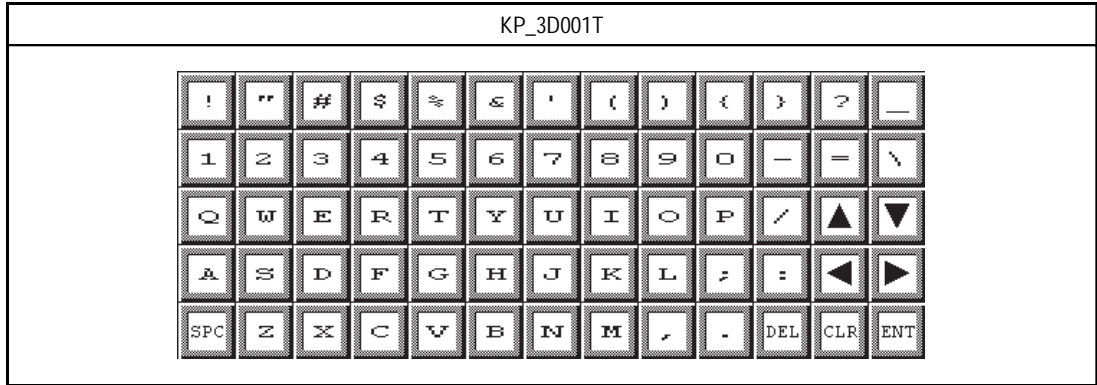

■ **Functions**

	Color Settings
	Pad Color
KP_3D001T*	✓

* The KP_3D001T cannot be used with the GP-270/370/H70 series.

11.6 Keypad <Text> Plain Parts01 OP4-PL01.PDB

Characters following the part number indicate the type of the Keypad.

KP_PL001T D:Dec, H:Hex, T:Text

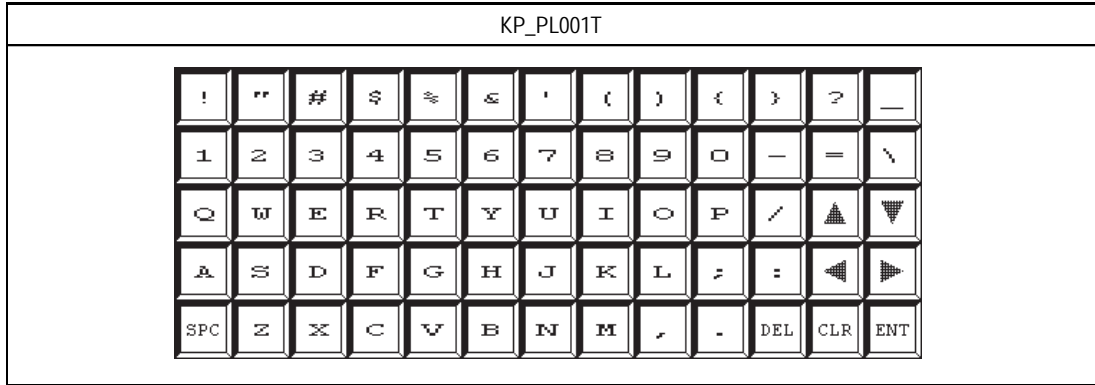











■ **Functions**

	Color Settings
	Pad Color
KP_PL001T*1	✓

*1 The KP_PL001T cannot be used with the GP-270/370/H70 series.

12 Keypad Input Displays

12.1 Keypad Display 3D Parts01 OP4-3D01.PDB

KD_3D001	KD_3D002	KD_3D003	KD_3D004
			
KD_3D005	KD_3D006	KD_3D007	KD_3D008
			
KD_3D009	KD_3D010		
			











■ Functions

	Address used		Color Settings				Address used		Color Settings		
	Word	Bit	Border	Text	Plate		Word	Bit	Border	Text	Plate
KD_3D001	✓	✓	✓	✓	✓	KD_3D007	✓	✓	✓	✓	✓
KD_3D002	✓	✓	✓	✓	✓	KD_3D008	✓	✓	✓	✓	✓
KD_3D003	✓	✓		✓	✓	KD_3D009	✓	✓	✓	✓	✓
KD_3D004	✓	✓	✓	✓	✓	KD_3D010	✓	✓	✓	✓	✓
KD_3D005	✓	✓	✓	✓	✓						
KD_3D006	✓	✓	✓	✓	✓						



Be sure not to set the plate color to "dark green" (color no. 255) when using the GP2000 series with the 256-color settings. The text will not be displayed properly on the GP unit.

12.2 Keypad Display Plain Parts01 OP4-PL01.PDB

KD_PL001	KD_PL002	KD_PL003	KD_PL004
			
KD_PL005	KD_PL006	KD_PL007	KD_PL008
			
KD_PL009	KD_PL010		
			

■ **Functions**

	Address used		Color Settings				Address used		Color Settings		
	Word	Bit	Border	Text	Plate		Word	Bit	Border	Text	Plate
KD_PL001	✓	✓	✓	✓	✓	KD_PL007	✓	✓	✓	✓	✓
KD_PL002	✓	✓	✓	✓	✓	KD_PL008	✓	✓	✓	✓	✓
KD_PL003	✓	✓		✓	✓	KD_PL009	✓	✓	✓	✓	✓
KD_PL004	✓	✓	✓	✓	✓	KD_PL010	✓	✓	✓	✓	✓
KD_PL005	✓	✓	✓	✓	✓						
KD_PL006	✓	✓	✓	✓	✓						



Be sure not to set the plate color to "dark green" (color no. 255) when using the GP2000 series with the 256-color settings. The text will not be displayed properly on the GP unit.

13 Numeric Displays

13.1 Numeric Display 3D Parts01 OP4-3D01.PDB











ND_3D001	ND_3D002	ND_3D003	ND_3D004
ND_3D005	ND_3D006	ND_3D007	ND_3D008
ND_3D009	ND_3D010		

■ Functions

	Address used	Color Settings				Address used	Color Settings		
	Word	Border	Text	Plate		Word	Border	Text	Plate
ND_3D001	✓	✓	✓	✓	ND_3D007	✓	✓	✓	✓
ND_3D002	✓	✓	✓	✓	ND_3D008	✓	✓	✓	✓
ND_3D003	✓		✓	✓	ND_3D009	✓	✓	✓	✓
ND_3D004	✓	✓	✓	✓	ND_3D010	✓	✓	✓	✓
ND_3D005	✓	✓	✓	✓					
ND_3D006	✓	✓	✓	✓					

Note: Be sure not to set the plate color to "dark green" (color no. 255) when using the GP2000 series with the 256-color settings. The text will not be displayed properly on the GP unit.

13.2 Numeric Display Plain Parts01 OP4-PL01.PDB

ND_PL001	ND_PL002	ND_PL003	ND_PL004
			
ND_PL005	ND_PL006	ND_PL007	ND_PL008
			
ND_PL009	ND_PL010		
			

■ **Functions**











	Address used		Color Settings				Address used		Color Settings		
	Word	Border	Text	Plate	Word		Border	Text	Plate		
ND_PL001	✓	✓	✓	✓	ND_PL007	✓	✓	✓	✓		
ND_PL002	✓	✓	✓	✓	ND_PL008	✓	✓	✓	✓		
ND_PL003	✓		✓	✓	ND_PL009	✓	✓	✓	✓		
ND_PL004	✓	✓	✓	✓	ND_PL010	✓	✓	✓	✓		
ND_PL005	✓	✓	✓	✓							
ND_PL006	✓	✓	✓	✓							



Be sure not to set the plate color to "dark green" (color no. 255) when using the GP2000 series with the 256-color settings. The text will not be displayed properly on the GP unit.

14 Message Displays

14.1 Message Display 3D Parts01 OP4-3D01.PDB











MD_3D001	MD_3D002	MD_3D003	MD_3D004
			
MD_3D005	MD_3D006	MD_3D007	MD_3D008
			
MD_3D009	MD_3D010		
			

■ Functions

	Address used		Color Settings				Address used		Color Settings		
	Word	Bit	Border	Text	Plate		Word	Bit	Border	Text	Plate
MD_3D001	✓	✓	✓	✓	✓	MD_3D007	✓	✓	✓	✓	✓
MD_3D002	✓	✓	✓	✓	✓	MD_3D008	✓	✓	✓	✓	✓
MD_3D003	✓	✓		✓	✓	MD_3D009	✓	✓	✓	✓	✓
MD_3D004	✓	✓	✓	✓	✓	MD_3D010	✓	✓	✓	✓	✓
MD_3D005	✓	✓	✓	✓	✓						
MD_3D006	✓	✓	✓	✓	✓						

 **Be sure not to set the plate color to "dark green" (color no. 255) when using the GP2000 series with the 256-color settings. The text will not be displayed properly on the GP unit.**

14.2 Message Display Plain Parts01 OP4-PL01.PDB

MD_PL001	MD_PL002	MD_PL003	MD_PL004
			
MD_PL005	MD_PL006	MD_PL007	MD_PL008
			
MD_PL009	MD_PL010		
			

■ **Functions**

	Address used		Color Settings				Address used		Color		
	Word	Bit	Border	Text	Plate		Word	Bit	Border	Text	Plate
MD_PL001	✓	✓	✓	✓	✓	MD_PL007	✓	✓	✓	✓	✓
MD_PL002	✓	✓	✓	✓	✓	MD_PL008	✓	✓	✓	✓	✓
MD_PL003	✓	✓		✓	✓	MD_PL009	✓	✓	✓	✓	✓
MD_PL004	✓	✓	✓	✓	✓	MD_PL010	✓	✓	✓	✓	✓
MD_PL005	✓	✓	✓	✓	✓						
MD_PL006	✓	✓	✓	✓	✓						



Be sure not to set the plate color to "dark green" (color no. 255) when using the GP2000 series with the 256-color settings. The text will not be displayed properly on the GP unit.

15 Date Displays

15.1 Date Display 3D Parts01 OP4-3D01.PDB

DD_3D001	DD_3D002	DD_3D003	DD_3D004
DD_3D005	DD_3D006	DD_3D007	DD_3D008
DD_3D009	DD_3D010		











■ Functions

	Color Settings				Color Settings		
	Border	Text	Plate		Border	Text	Plate
DD_3D001	✓	✓	✓	DD_3D007	✓	✓	✓
DD_3D002	✓	✓	✓	DD_3D008	✓	✓	✓
DD_3D003		✓	✓	DD_3D009	✓	✓	✓
DD_3D004	✓	✓	✓	DD_3D010	✓	✓	✓
DD_3D005	✓	✓	✓				
DD_3D006	✓	✓	✓				



Be sure not to set the plate color to "dark green" (color no. 255) when using the GP2000 series with the 256-color settings. The text will not be displayed properly on the GP unit.

15.2 **Date Display Plain Parts01** OP4-PL01.PDB

DD_PL001	DD_PL002	DD_PL003	DD_PL004
			
DD_PL005	DD_PL006	DD_PL007	DD_PL008
			
DD_PL009	DD_PL010		
			

■ **Functions**

	Color Settings				Color Settings		
	Border	Text	Plate		Border	Text	Plate
DD_PL001	✓	✓	✓	DD_PL007	✓	✓	✓
DD_PL002	✓	✓	✓	DD_PL008	✓	✓	✓
DD_PL003		✓	✓	DD_PL009	✓	✓	✓
DD_PL004	✓	✓	✓	DD_PL010	✓	✓	✓
DD_PL005	✓	✓	✓				
DD_PL006	✓	✓	✓				



Be sure not to set the plate color to "dark green" (color no. 255) when using the GP2000 series with the 256-color settings. The text will not be displayed properly on the GP unit.

16 Time Displays

16.1 Time Display 3D Parts01 OP4-3D01.PDB

TD_3D001	TD_3D002	TD_3D003	TD_3D004
TD_3D005	TD_3D006	TD_3D007	TD_3D008
TD_3D009	TD_3D010		











■ Functions

	Color Settings				Color Settings		
	Border	Text	Plate		Border	Text	Plate
TD_3D001	✓	✓	✓	TD_3D007	✓	✓	✓
TD_3D002	✓	✓	✓	TD_3D008	✓	✓	✓
TD_3D003		✓	✓	TD_3D009	✓	✓	✓
TD_3D004	✓	✓	✓	TD_3D010	✓	✓	✓
TD_3D005	✓	✓	✓				
TD_3D006	✓	✓	✓				



Note: Be sure not to set the plate color to "dark green" (color no. 255) when using the GP2000 series with the 256-color settings. The text will not be displayed properly on the GP unit.

16.2 Time Display Plain Parts01 OP4PL01.PDB

TD_PL001	TD_PL002	TD_PL003	TD_PL004
			
TD_PL005	TD_PL006	TD_PL007	TD_PL008
			
TD_PL009	TD_PL010		
			

■ **Functions**

	Color Settings				Color Settings		
	Border	Text	Plate		Border	Text	Plate
TD_PL001	✓	✓	✓	TD_PL007	✓	✓	✓
TD_PL002	✓	✓	✓	TD_PL008	✓	✓	✓
TD_PL003		✓	✓	TD_PL009	✓	✓	✓
TD_PL004	✓	✓	✓	TD_PL010	✓	✓	✓
TD_PL005	✓	✓	✓				
TD_PL006	✓	✓	✓				



Be sure not to set the plate color to "dark green" (color no. 255) when using the GP2000 series with the 256-color settings. The text will not be displayed properly on the GP unit.

17 Libraries

- | | | |
|--------------------------|----------------------------------|------------------------------|
| 1 Library File Content | 10 Volume Switch | 19 Window Display Tool |
| 2 Address of the Library | 11 Numeric Input Key | 20 2 Button Safety Switch |
| 3 Address Setup | 12 LED Lamp | 21 Alarm Display #1 |
| 4 3-state Switch | 13 I/O Monitor | 22 Alarm Display #2 |
| 5 Rotary Switch | 14 Device Monitor | 23 Alarm Display #3 |
| 6 Slide Switch | 15 Timer | 24 Active Image Display Tool |
| 7 Selector Switch | 16 Counter | 25 Filing Data Edit Tool |
| 8 Digital Switch | 17 Heat Control | 26 Logging Keypad-Decimal |
| 9 Digital Switch2 | 18 Add/Subtract Momentary Switch | 27 Logging Keypad-Hex |

17.1 Library File Contents

The Library File is where the parts, graphics, and other items are put together and registered. The registered library file is read and used when required. The “Library File” is also called the “CPW file”, indicated by the extension “CPW”. When laying out the library, refer to the following table.

Function	Address used	Filename	Title
3-state Switch	Bit/word	OP4-LIB1.CPW	Data Input Equipment Library Parts
Rotary Switch			
Slide Switch			
Selector Switch			
Digital Switch			
Volume Switch	Word	OP4-LIB2.CPW	Monitor Equipment Library Parts
Numeric Input Key	Bit & word		
LED Lamp	Bit		
I/O Monitor	Bit/word	OP4-LIB3.CPW	Multifunction Equipment Library Parts
Device Monitor			
Timer	Bit & word	OP4-LIB4.CPW	Application Library Parts
Counter			
Heat Control			
Add/Subtract Momentary Switch	---	OP4-LIB4.CPW	Application Library Parts
Window Display Tool			
2 Button Safety Switch			
Alarm Display #1			
Alarm Display #2			
Alarm Display #3			
Active Image Display Tool			
Filing Data Edit Tool			
Logging Ten Key - Decimal			
Logging Ten Key - Hex			
Digital Switch 2	Word	OP4-LIB5.CPW	Data Input Equipment 2 Library Parts
Template	---	OP4-OBJ.ACPW	3D Template Switch Parts
		OP4-OBJ.B.CPW	Plain Template Switch Parts
		OP4-OBJ.C.CPW	3D Template Lamp Parts
		OP4-OBJ.D.CPW	Plain Template Lamp Parts
		OP4-OBJ.E.CPW	Template Display Parts
		OP4-OBJ.F.CPW	3D Template Keypad Parts
		OP4-OBJ.G.CPW	Plain Template Keypad Parts
OP4-OBJ.H.CPW	Template Screen Background Parts		

17.2 Library Addresses

There are two types of addresses in the library; the addresses of the PLC which are written directly into the PLC during operation and the addresses of the LS area. The LS area means the area prepared for the memory inside the GP. Because the LS area does not write data into the PLC, efficiency of data processing is improved.

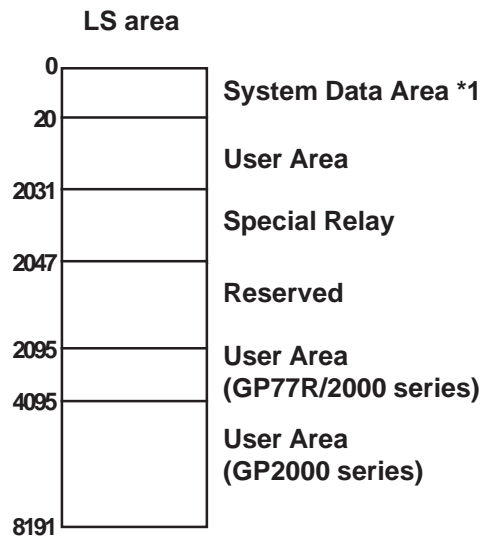

The library uses the LS area for the data other than those which are sent to the PLC for efficient animation.

Be sure to use the LS area for the parts when the address of the initial value is set to LS.



- **When the address of the LS area of the initial value is the same in one library Part, change addresses to ensure that those addresses will be the same addresses. If respective addresses are changed differently, motion cannot be guaranteed.**
- **When two or more library Parts are placed, prevent LS areas of parts from overlapping when setting.**

*1 Because the content of the data to be written into the System Data Area is determined according to the address, do not use the system data area in the library. The LS areas that can be used are from word 20 to 2031 and from word 2096 to 4095 (with the GP77R series), or from word 2096 to 8191 (with the GP2000 series).

17.3 Address Setup

After a library item has been placed on a screen, double-click on it and the pop-up address information window, titled "Confirm Device Address" will be displayed. Exception: Template Parts. (OP4-OBJA.CPW to OP4-OBJH.CPW)

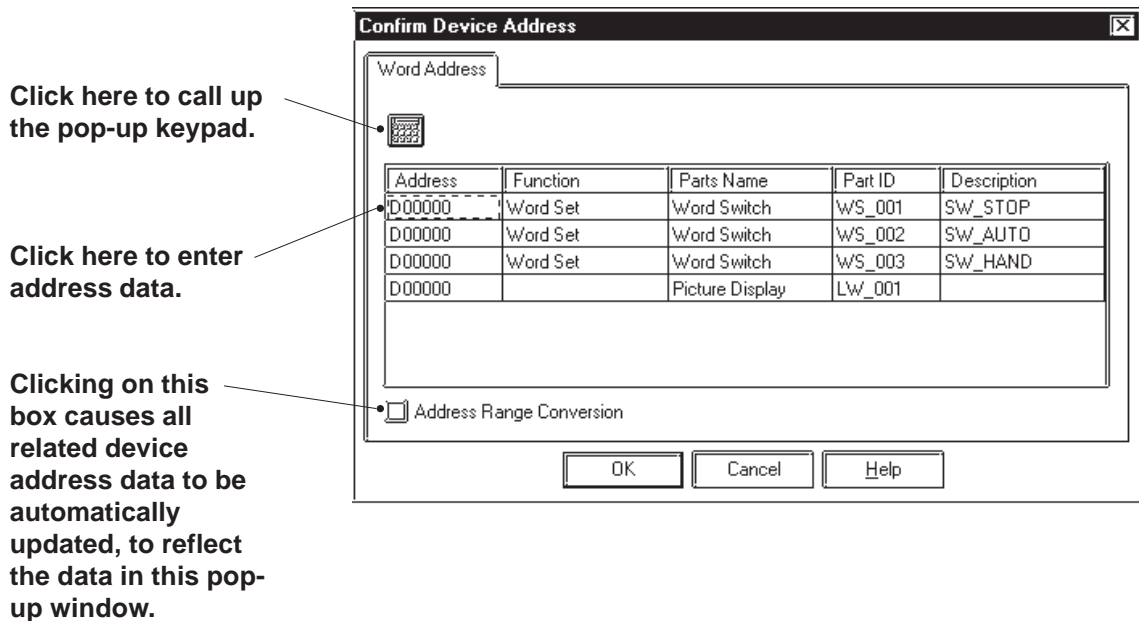

Data for addresses is not stored in the GP while the GP is running. If you wish to save this data, use the PLC's backup memory when designating addresses. However, backup memory will vary depending on the PLC, so please refer to your PLC's User Manual prior to setting these addresses.

Ex. When using a Mitsubishi PLC:

- Use R registers
- Use Backup D registers

17.4 **3-state Switches** Data Input Equipment OP4-LIB1.CPW

- The arrow changes into the touched direction and is set as the status of the word address or the bit address.
- The 3-state Switch has the 3-state SW word and bit.

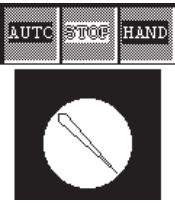
Part sample	Number and name of part
3-state Switch 	1: 3-state SW word 2: 3-state SW bit

In this section, the word and bit of 3-state SW are used as examples for explanation.

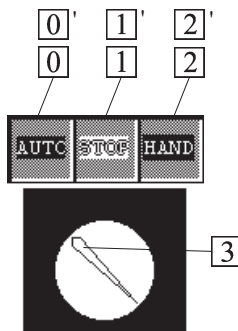

■ **3-state SW word**

Values from 0000 through 0002 can be set to the specified word address.

Ex.) 3-state SW word

No.	Address	Function	Part Name	Description	Comment
1	D0000	Data set	Word Switch	SW_STOP	When touched, this switch sets 0001 to the word address.
0	D0000	Data set	Word Switch	SW_AUTO	When touched, this switch sets 0000 to the word address.
2	D0000	Data set	Word Switch	SW_HAND	When touched, this switch sets 0002 to the word address.
3	D0000	---	Picture Display	LW_1	Word address which indicates the direction of arrow.

- The address is the initial value. It can be changed and used.
- The address occupies one word.



From 0 to 3, set the same address.

■ **3-state SW Bit**

Error bit 00 to bit 02 of the specified word address, only one bit can be set to ON state (exclusive processing).

Ex.) 3-state SW bit

No.	Address	Function	Part Name	Description	Comment
3	LS1000	---	Picture Display	LW_1	Word address which indicates the direction of arrow.
0	LS1000	Data set	Word Switch	SW_0	The word address indicating the direction of arrow. When touched, this switch sets 0002 to the word address.
1	LS1000	Data set	Word Switch	SW_1	
2	LS1000	Data set	Word Switch	SW_2	
0	M0000	Data set	Word Switch	SW_AUTO	When touched, the switch turns on bit 00 of the specified word address, and the other bits are turned OFF.
2	M0000	Data set	Word Switch	SW_HAND	When touched, the switch turns on bit 01 of the specified word address, and the other bits are turned OFF.
1	M0000	Data set	Word Switch	SW_STOP	When touched, the switch turns on bit 02 of the specified word address, and the other bits are turned OFF.

- The address is the initial value. It can be changed and used.
- The address occupies one word. The higher bits not used by the Part cannot be guaranteed.
- When placing two or more Parts, change the address of the LS area for each Part. When the address is not changed, Parts that are placed perform the same operations.



- **From 0 to 3, set the same address.**
- **From 0' to 2', set the same address.**

17.5 Rotary Switches Data Input Equipment OP4-LIB1.CPW

- The arrow changes into the touched direction and is set as the status of the word address or the bit address.
- The Rotary Switch has the Rotary SW word 3, bit 3, word 4, bit 4, word 5, bit 5, word 6, bit 6, word 7, bit 7, word 8, and bit 8.

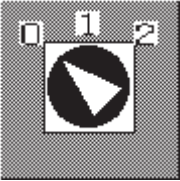
Part sample	Number and name of part
Rotary Switch 	3: Rotary SW word3 4: Rotary SW bit3 5: Rotary SW word4 6: Rotary SW bit4 7: Rotary SW word5 8: Rotary SW bit5 9: Rotary SW Word6 10: Rotary SW bit6 11: Rotary SW word7 12: Rotary SW bit7 13: Rotary SW word8 14: Rotary SW bit8

The last numeric value of the part name indicates the number of switches.

In this section, Rotary SW word 8 and bit 8 are used as examples for explanation.

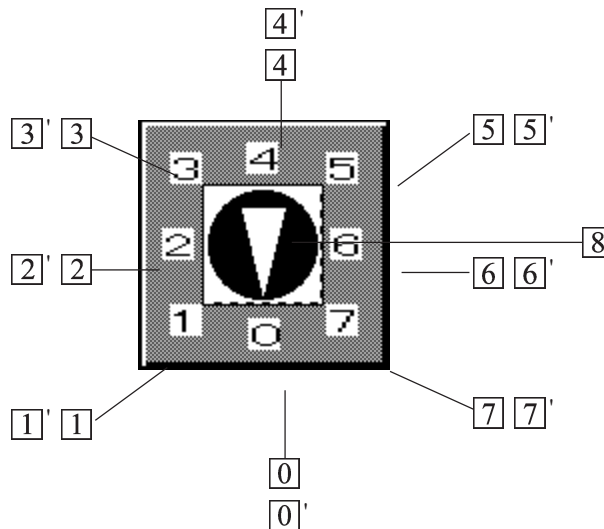

■ Rotary SW Word

Values from 0000 through 0007 can be set to the specified word address.

Ex.) Rotary SW word8

No.	Address	Function	Part Name	Description	Comment
0	D0000	Data Set	Word Switch	SW_0	When touched, the switch sets 0000 to the specified word address.
1	D0000	Data Set	Word Switch	SW_1	When touched, the switch sets 0001 to the specified word address.
2	D0000	Data Set	Word Switch	SW_2	When touched, the switch sets 0002 to the specified word address.
3	D0000	Data Set	Word Switch	SW_3	When touched, the switch sets 0003 to the specified word address.
4	D0000	Data Set	Word Switch	SW_4	When touched, the switch sets 0004 to the specified word address.
5	D0000	Data set	Word Switch	SW_5	When touched, the switch sets 0005 to the specified word address.
6	D0000	Data Set	Word Switch	SW_6	When touched, the switch sets 0006 to the specified word address.
7	D0000	Data Set	Word Switch	SW_7	When touched, the switch sets 0007 to the specified word address.
8	D0000	---	Picture Display	LW_1	Word address which indicates the direction of arrow.

- The address is the initial value. It can be changed and used.
- The address occupies one word.



From 0 to 8, set the same address.

■ Rotary SW Bit

Within bit 00 to bit 07 of the specified word address, only one bit can be set to ON state (exclusive processing).

Ex.) Rotary SW bit8

No.	Address	Function	Part Name	Description	Comment
0	LS1000	Data Set	Word Switch	SW_0	The word address indicating the direction of arrow.
1	LS1000	Data Set	Word Switch	SW_1	
2	LS1000	Data Set	Word Switch	SW_2	
3	LS1000	Data Set	Word Switch	SW_3	
4	LS1000	Data Set	Word Switch	SW_4	
5	LS1000	Data Set	Word Switch	SW_5	
6	LS1000	Data Set	Word Switch	SW_6	
7	LS1000	Data Set	Word Switch	SW_7	
8	LS1000	---	Picture Display	LW_1	Word address which indicates the direction of arrow.
0	M0000	Data Set	Word Switch	SW_0B	When touched, the switch turns on bit 00 of the specified word address.
1	M0000	Data Set	Word Switch	SW_1B	When touched, the switch turns on bit 01 of the specified word address.
2	M0000	Data Set	Word Switch	SW_2B	When touched, the switch turns on bit 02 of the specified word address.
3	M0000	Data Set	Word Switch	SW_3B	When touched, the switch turns on bit 03 of the specified word address.
4	M0000	Data Set	Word Switch	SW_4B	When touched, the switch turns on bit 04 of the specified word address.
5	M0000	Data Set	Word Switch	SW_5B	When touched, the switch turns on bit 05 of the specified word address.
6	M0000	Data Set	Word Switch	SW_6B	When touched, the switch turns on bit 06 of the specified word address.
7	M0000	Data Set	Word Switch	SW_7B	When touched, the switch turns on bit 07 of the specified word address.

- The address is the initial value. It can be changed and used.



- **From 0 to 8, set the same address.**
- **From 0 to 7, set the same address.**
- **The address occupies one word. The higher bits not used by the Part cannot be guaranteed.**
- **When placing two or more Parts, change the address of the LS area. When the address is not changed, Parts that are placed make the same operations.**

17.6

Slide Switches Data Input Equipment

OP4-LIB1.CPW

- The knob moves to the touched area and data are set to the bit address or the word address.
- The Slide Switch has the Slide SW word 3, bit 3, word 4, bit 4, word 5, bit 5, word 6, bit 6, word 7, bit 7, word 8, and bit 8.

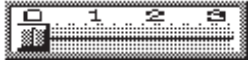
Part sample	Number and name of part
Slide Switch 	15: Slide SW word3 16: Slide SW bit3 17: Slide SW word4 18: Slide SW bit4 19: Slide SW word5 20: Slide SW bit5 21: Slide SW word6 22: Slide SW bit6 23: Slide SW word7 24: Slide SW bit7 25: Slide SW word8 26: Slide SW bit8

The last numeric value of the part name indicates the number of switches.

In this section, Slide SW word 8 and bit 8 are used as examples for explanation.

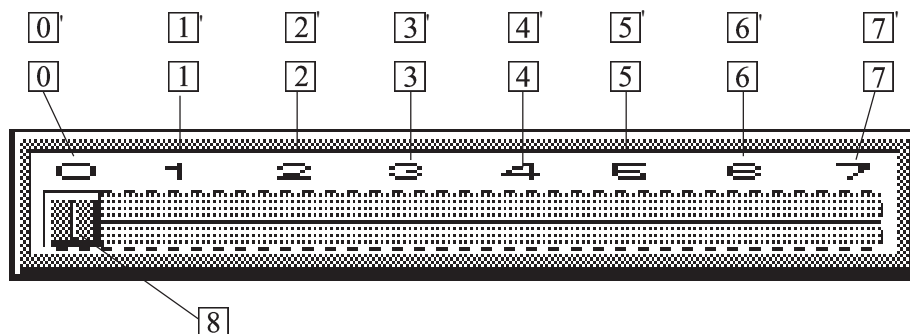

■ Slide SW Word

Values from 0000 through 0007 can be set to the specified word address.

Ex.) Slide SW word8

No.	Address	Function	Part Name	Description	Comment
0	D0000	Data Set	Word Switch	SW_0	When touched, the switch sets 0000 to the specified word address.
1	D0000	Data Set	Word Switch	SW_1	When touched, the switch sets 0001 to the specified word address.
2	D0000	Data Set	Word Switch	SW_2	When touched, the switch sets 0002 to the specified word address.
3	D0000	Data Set	Word Switch	SW_3	When touched, the switch sets 0003 to the specified word address.
4	D0000	Data Set	Word Switch	SW_4	When touched, the switch sets 0004 to the specified word address.
5	D0000	Data Set	Word Switch	SW_5	When touched, the switch sets 0005 to the specified word address.
6	D0000	Data Set	Word Switch	SW_6	When touched, the switch sets 0006 to the specified word address.
7	D0000	Data Set	Word Switch	SW_7	When touched, the switch sets 0007 to the specified word address.
8	D0000	---	Picture Display	LW_1	Word address of the knob indicating the position.

- The address is the initial value. It can be changed and used.
- The address occupies one word.



From 0 to 8, set the same address.

■ Slide SW Bit

Within bit 00 to bit 07 of the specified word address, only one bit can be set to ON state (exclusive processing).

Ex.) Slide SW bit8

No.	Address	Function	Part Name	Description	Comment
0	LS1000	Data Set	Word Switch	SW_0	Address to control the position of the knob.
1	LS1000	Data Set	Word Switch	SW_1	
2	LS1000	Data Set	Word Switch	SW_2	
3	LS1000	Data Set	Word Switch	SW_3	
4	LS1000	Data Set	Word Switch	SW_4	
5	LS1000	Data Set	Word Switch	SW_5	
6	LS1000	Data Set	Word Switch	SW_6	
7	LS1000	Data Set	Word Switch	SW_7	
8	LS1000	---	Picture Display	LW_1	Word address to indicate the position of the knob.
0	M0000	Data Set	Word Switch	SW_0B	When touched, the switch turns on bit 00 of the specified word address.
1	M0000	Data Set	Word Switch	SW_1B	When touched, the switch turns on bit 01 of the specified word address.
2	M0000	Data Set	Word Switch	SW_2B	When touched, the switch turns on bit 02 of the specified word address.
3	M0000	Data Set	Word Switch	SW_3B	When touched, the switch turns on bit 03 of the specified word address.
4	M0000	Data Set	Word Switch	SW_4B	When touched, the switch turns on bit 04 of the specified word address.
5	M0000	Data Set	Word Switch	SW_5B	When touched, the switch turns on bit 05 of the specified word address.
6	M0000	Data Set	Word Switch	SW_6B	When touched, the switch turns on bit 06 of the specified word address.
7	M0000	Data Set	Word Switch	SW_7B	When touched, the switch turns on bit 07 of the specified word address.

- The address is the initial value. It can be changed and used.



- **From 0 to 8, set the same address.**
- **From 0 to 7, set the same address.**
- **The address occupies one word. The higher bits not used by the Part cannot be guaranteed.**

17.7 Selector Switches Data Input Equipment OP4-LIB1.CPW

- Sets only the one touched position to ON state (exclusive processing).
- Sets the data of ON state switch to the bit address or the word address.
- The Selector Switch has the Selector SW word 3, bit 3, word 4, bit 4, word 5, bit 5, word 6, bit 6, word 7, bit 7, word 8, and bit 8.

Part sample	Number and name of part
Selector Switch 	27: Selector SW word3 28: Selector SW bit3 29: Selector SW word4 30: Selector SW bit4 31: Selector SW word5 32: Selector SW bit5 33: Selector SW word6 34: Selector SW bit6 35: Selector SW word7 36: Selector SW bit7 37: Selector SW word8 38: Selector SW bit8

The last numeric value of the part name indicates the number of switches.

In this section, Selector SW word 8 and bit 8 are used as examples for explanation.

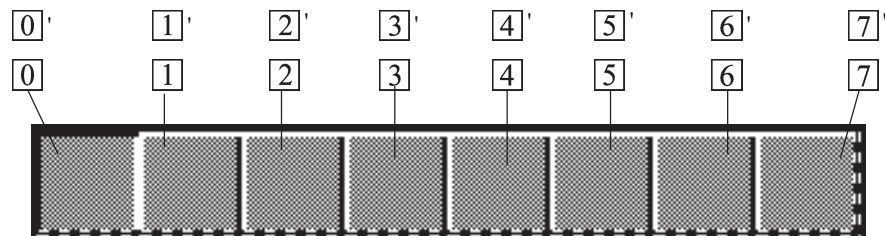

■ Selector SW Word

Values from 0000 through 0007 can be set to the specified word address.

Ex.) Selector SW word8

No.	Address	Function	Part Name	Description	Comment
0	D0000	Data Set	Word Switch	SW_0	When touched, the switch sets 0000 to the specified word address.
1	D0000	Data Set	Word Switch	SW_1	When touched, the switch sets 0001 to the specified word address.
2	D0000	Data Set	Word Switch	SW_2	When touched, the switch sets 0002 to the specified word address.
3	D0000	Data Set	Word Switch	SW_3	When touched, the switch sets 0003 to the specified word address.
4	D0000	Data Set	Word Switch	SW_4	When touched, the switch sets 0004 to the specified word address.
5	D0000	Data Set	Word Switch	SW_5	When touched, the switch sets 0005 to the specified word address.
6	D0000	Data Set	Word Switch	SW_6	When touched, the switch sets 0006 to the specified word address.
7	D0000	Data Set	Word Switch	SW_7	When touched, the switch sets 0007 to the specified word address.
8	D0000	---	Picture Display	LW_1	Word address indicating the picture of the switch.

- The address is the initial value. It can be changed and used.
- The address of vertical type Selector Switch is set in ascending order from the top.



- **From 0 to 8, set the same address.**
- **The address occupies one word. Operations of the higher bits cannot be guaranteed.**

■ **Selector SW Bit**

Within bit 00 to bit 07 of the specified word address, only one bit can be set to ON state (exclusive processing).

Ex.) Selector SW bit8

No.	Address	Function	Part Name	Description	Comment
0	LS1000	Data Set	Word Switch	SW_0	Address controlling the switch position.
1	LS1000	Data Set	Word Switch	SW_1	
2	LS1000	Data Set	Word Switch	SW_2	
3	LS1000	Data Set	Word Switch	SW_3	
4	LS1000	Data Set	Word Switch	SW_4	
5	LS1000	Data Set	Word Switch	SW_5	
6	LS1000	Data Set	Word Switch	SW_6	
7	LS1000	Data Set	Word Switch	SW_7	
8	LS1000	---	Picture Display	LW_1	Word address indicating the switch.
0	M0000	Data Set	Word Switch	SW_0B	When touched, the switch turns on bit 00 of the specified word address.
1	M0000	Data Set	Word Switch	SW_1B	When touched, the switch turns on bit 01 of the specified word address.
2	M0000	Data Set	Word Switch	SW_2B	When touched, the switch turns on bit 02 of the specified word address.
3	M0000	Data Set	Word Switch	SW_3B	When touched, the switch turns on bit 03 of the specified word address.
4	M0000	Data Set	Word Switch	SW_4B	When touched, the switch turns on bit 04 of the specified word address.
5	M0000	Data Set	Word Switch	SW_5B	When touched, the switch turns on bit 05 of the specified word address.
6	M0000	Data Set	Word Switch	SW_6B	When touched, the switch turns on bit 06 of the specified word address.
7	M0000	Data Set	Word Switch	SW_7B	When touched, the switch turns on bit 07 of the specified word address.

- The address is the initial value. It can be changed and used.



- **From 0 to 8, set the same address.**
- **From 0 to 7, set the same address.**

17.8 Digital Switches Data Input Equipment OP4-LIB1.CPW

- When the arrow key is touched, data of the digit touched are added, subtracted and set to the specified word address.
- There are 2-digit Dec, Hex, 3-digit Dec, Hex, 4-digit Dec, and Hex for the Digital Switches.
- This part requires a ladder program. Refer to the example 1 of ladder program on the following page.

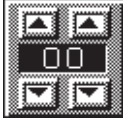
Part sample	Number and name of part
Digital Switch 	39: Digital SW 2digit DEC 40: Digital SW 2digit HEX 41: Digital SW 3digit DEC 42: Digital SW 3digit HEX 43: Digital SW 4digit DEC 44: Digital SW 4digit HEX

- In this section, Digital SW 4-digit Dec and Hex are used as examples for explanation.

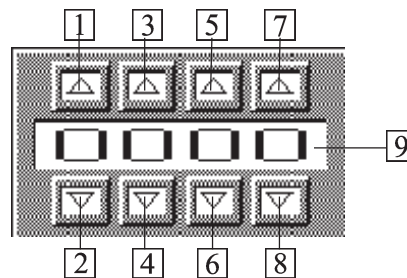

■ Digital SW Dec

Dec data can be set to the specified word address.

Ex.) Digital SW 4digit DEC

No.	Address	Function	Part Name	Description	Comment
1	D0000	Addition/subtraction	Word Switch	SW_+1000	Switch for adding to data of the place of 1000.
2	D0000	Addition/subtraction	Word Switch	SW_-1000	Switch for subtracting to data of the place of 1000.
3	D0000	Addition/subtraction	Word Switch	SW_+100	Switch for adding to data of the place of 100.
4	D0000	Addition/subtraction	Word Switch	SW_-100	Switch for subtracting to data of the place of 100.
5	D0000	Addition/subtraction	Word Switch	SW_+10	Switch for adding to data of the place of 10.
6	D0000	Addition/subtraction	Word Switch	SW_-10	Switch for subtracting data of the place of 10.
7	D0000	Addition/subtraction	Word Switch	SW_+1	Switch for adding to data of the place of 1.
8	D0000	Addition/subtraction	Word Switch	SW_-1	Switch for subtracting data of the place of 1.
9	D0000	---	Numeric Display	NU_1	Indicates numeric values.



- **The address is the initial value. It can be changed and used.**
- **From [0] to [9], set the same address.**
- **The address occupies one word. Data of the digit which is not use in the part cannot be guaranteed.**

The following data which can be entered are given as the reference.

Displayed digit \ Entry data format	Dec (Decimal)	Hex (Hexadecimal)
2 digits	0000-0099	0000-0063h
3 digits	0000-0099	0000-03E7h
4 digits	0000-0099	0000-270Fh

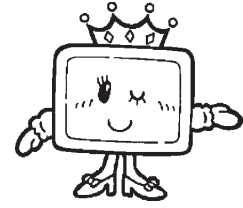

■ Digital SW Hex

Dec data can be set to the specified word address.

Ex.) Digital SW 4 digit HEX

No.	Address	Function	Part Name	Description	Comment
1	D0000	Addition/subtraction	Word Switch	SW_+4096	Switch for adding to data of the place of 1000.
2	D0000	Addition/subtraction	Word Switch	SW_-4096	Switch for subtracting to data of the place of 1000.
3	D0000	Addition/subtraction	Word Switch	SW_+256	Switch for adding to data of the place of 100.
4	D0000	Addition/subtraction	Word Switch	SW_-256	Switch for subtracting to data of the place of 100.
5	D0000	Addition/subtraction	Word Switch	SW_+16	Switch for adding to data of the place of 10.
6	D0000	Addition/subtraction	Word Switch	SW_-16	Switch for subtracting data of the place of 10.
7	D0000	Addition/subtraction	Word Switch	SW_+1	Switch for adding to data of the place of 1.
8	D0000	Addition/subtraction	Word Switch	SW_-1	Switch for subtracting data of the place of 1.
9	D0000	---	Numeric Display	NU_1	Indicates numeric values.



- **The address is the initial value. It can be changed and used.**
- **From 1 to 9, set the same address.**
- **The address occupies one word. Data of the digit which is not use in the part cannot be guaranteed.**

The following data which can be entered are given as the reference.

Displayed digit \ Entry data format	Hex (Hexadecimal)
2 digits	00-FFh
3 digits	000-FFFh
4 digits	0000-FFFFh

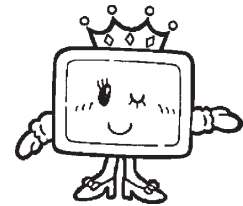

- This Part requires a ladder program. Refer to example 1 of the ladder program on the following page.

■ Ladder program Example #1

In the case of 0000 to 9999 for 4 digit Dec.

The ladder program indicates the method for controlling the upper limit and the lower limit.

For Mitsubishi Electric MELSEC series

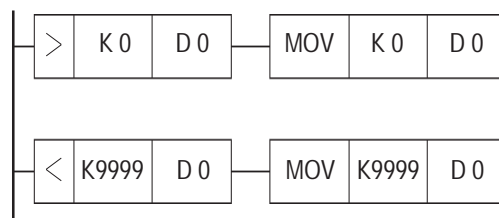



D0: Specify the address of 1 to 9.

17.9

Digital Switches2 Data Input Equipment2 OP4-LIB5.CPW



Important

- When the   is touched, data of the digit touched are added, subtracted and set to the specified word address.
- These digits operate independently, therefore, when one is increased past 9 or decreased past 0, all surrounding digits will not change.

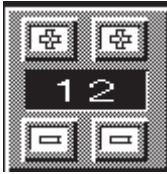
Part sample	Number and name of part	
Digital Switch 	1: Digital SW 2digit BCD 2: Digital SW 2digit HEX 3: Digital SW 3digit BCD 4: Digital SW 3digit HEX 5: Digital SW 4digit BCD 6: Digital SW 4digit HEX 7: Digital SW 5digit BCD 8: Digital SW 5digit HEX 9: Digital SW 6digit BCD 10: Digital SW 6digit HEX 11: Digital SW 7digit BCD 12: Digital SW 7digit HEX 13: Digital SW 8digit BCD 14: Digital SW 8digit HEX	15: (LS)Digital SW 5digit BCD 16: (LS)Digital SW 5digit HEX 17: (LS)Digital SW 6digit BCD 18: (LS)Digital SW 6digit HEX 19: (LS)Digital SW 7digit BCD 20: (LS)Digital SW 7digit HEX 21: (LS)Digital SW 8digit BCD 22: (LS)Digital SW 8digit HEX

In this section, Digital SW 5-digit BCD and Hex are used as examples for explanation.



■ Digital SW BCD

BCD data can be set to the specified word address.

Ex.) Digital SW 5 digit BCD

Word Address	Function	Part Name	Description	Comment
D0001	Digit(ADD)/BCD/1	Word Switch	SW_+5	Switch for adding to data of the place of 5.
D0001	Digit(SUB)/BCD/1	Word Switch	SW_-5	Switch for subtracting to data of the place of 5.
D0000	Digit(ADD)/BCD/4	Word Switch	SW_+4	Switch for adding to data of the place of 4.
D0000	Digit(SUB)/BCD/4	Word Switch	SW_-4	Switch for subtracting to data of the place of 4.
D0000	Digit(ADD)/BCD/3	Word Switch	SW_+3	Switch for adding to data of the place of 3.
D0000	Digit(SUB)/BCD/3	Word Switch	SW_-3	Switch for subtracting to data of the place of 3.
D0000	Digit(ADD)/BCD/2	Word Switch	SW_+2	Switch for adding to data of the place of 2.
D0000	Digit(SUB)/BCD/2	Word Switch	SW_-2	Switch for subtracting to data of the place of 2.
D0000	Digit(ADD)/BCD/1	Word Switch	SW_+1	Switch for adding to data of the place of 1.
D0000	Digit(SUB)/BCD/1	Word Switch	SW_-1	Switch for subtracting to data of the place of 1.
D0000	BCD32/5digit	Numeric Display	ND_1	Indicates numeric values.

■ (LS) Digital SW BCD

BCD data can be set to the specified word address.

Ex.) (LS) Digital SW 5 digit BCD

Word Address	Function	Part Name	Description	Comment
LS00000	Digit(ADD)/BCD/1	Word Switch	SW_+5	Switch for adding to data of the place of 5.
LS00000	Digit(SUB)/BCD/1	Word Switch	SW_-5	Switch for subtracting to data of the place of 5.
LS00001	Digit(ADD)/BCD/4	Word Switch	SW_+4	Switch for adding to data of the place of 4.
LS00001	Digit(SUB)/BCD/4	Word Switch	SW_-4	Switch for subtracting to data of the place of 4.
LS00001	Digit(ADD)/BCD/3	Word Switch	SW_+3	Switch for adding to data of the place of 3.
LS00001	Digit(SUB)/BCD/3	Word Switch	SW_-3	Switch for subtracting to data of the place of 3.
LS00001	Digit(ADD)/BCD/2	Word Switch	SW_+2	Switch for adding to data of the place of 2.
LS00001	Digit(SUB)/BCD/2	Word Switch	SW_-2	Switch for subtracting to data of the place of 2.
LS00001	Digit(ADD)/BCD/1	Word Switch	SW_+1	Switch for adding to data of the place of 1.
LS00001	Digit(SUB)/BCD/1	Word Switch	SW_-1	Switch for subtracting to data of the place of 1.
LS00000	BCD32/5digit	Numeric Display	ND_1	Indicates numeric values.

- The address is the initial value. It can be changed and used.



- **Please select “(LS) digital SW ***” as the part name in the following cases:**
 1. When the memory link setting is used.
 2. When an LS device is used.
 3. When a device which processes two-word data as H/L *1 is used.
- **A part’s address -up to four digits- will occupy one word. Part addresses of five digits or more will occupy two words. Data remaining in any unused digits cannot be assured.**
- **This part can only be used for a 16-bit device.**

<Changing addresses>

Click on the check box for “Change all addresses in 1 group.” Then, in the address field, enter the first address for the part’s numeric display, and then change all the addresses.

*1 For each device’s two-word processing, please refer to the PLC Connection Manual remarks in chapters 2-*3 and 5-*3, “Supported Devices”.

■ Digital SW Hex

Hex data can be set to the specified word address.

Ex.) Digital SW 5 digit Hex

Word Address	Function	Part Name	Description	Comment
D0001	Digit(ADD)/BIN/1	Word Switch	SW_+5	Switch for adding to data of the place of 5.
D0001	Digit(SUB)/BIN/1	Word Switch	SW_-5	Switch for subtracting to data of the place of 5.
D0000	Digit(ADD)/BIN/4	Word Switch	SW_+4	Switch for adding to data of the place of 4.
D0000	Digit(SUB)/BIN/4	Word Switch	SW_-4	Switch for subtracting to data of the place of 4.
D0000	Digit(ADD)/BIN/3	Word Switch	SW_+3	Switch for adding to data of the place of 3.
D0000	Digit(SUB)/BIN/3	Word Switch	SW_-3	Switch for subtracting to data of the place of 3.
D0000	Digit(ADD)/BIN/2	Word Switch	SW_+2	Switch for adding to data of the place of 2.
D0000	Digit(SUB)/BIN/2	Word Switch	SW_-2	Switch for subtracting to data of the place of 2.
D0000	Digit(ADD)/BIN/1	Word Switch	SW_+1	Switch for adding to data of the place of 1.
D0000	Digit(SUB)/BIN/1	Word Switch	SW_-1	Switch for subtracting to data of the place of 1.
D0000	HEX32/5digit	Numeric Display	ND_1	Indicates numeric values.

■ (LS) Digital SW Hex

Hex data can be set to the specified word address.

Ex.) (LS) Digital SW 5 digit Hex

Word Address	Function	Part Name	Description	Comment
LS00000	Digit(ADD)/BIN/1	Word Switch	SW_+5	Switch for adding to data of the place of 5.
LS00000	Digit(SUB)/BIN/1	Word Switch	SW_-5	Switch for subtracting to data of the place of 5.
LS00001	Digit(ADD)/BIN/4	Word Switch	SW_+4	Switch for adding to data of the place of 4.
LS00001	Digit(SUB)/BIN/4	Word Switch	SW_-4	Switch for subtracting to data of the place of 4.
LS00001	Digit(ADD)/BIN/3	Word Switch	SW_+3	Switch for adding to data of the place of 3.
LS00001	Digit(SUB)/BIN/3	Word Switch	SW_-3	Switch for subtracting to data of the place of 3.
LS00001	Digit(ADD)/BIN/2	Word Switch	SW_+2	Switch for adding to data of the place of 2.
LS00001	Digit(SUB)/BIN/2	Word Switch	SW_-2	Switch for subtracting to data of the place of 2.
LS00001	Digit(ADD)/BIN/1	Word Switch	SW_+1	Switch for adding to data of the place of 1.
LS00001	Digit(SUB)/BIN/1	Word Switch	SW_-1	Switch for subtracting to data of the place of 1.
LS00000	HEX32/5digit	Numeric Display	ND_1	Indicates numeric values.

- The address is the initial value. It can be changed and used.



- Please select “(LS) digital SW ***” as the part name in the following cases:
 1. When the memory link setting is used.
 2. When an LS device is used.
 3. When a device which processes two-word data as H/L *1 is used.
- A part’s address -up to four digits- will occupy one word. Part addresses of five digits or more will occupy two words. Data remaining in any unused digits cannot be assured.
- No overflow occurs with this digital switch. It only indicates values from 0 to 9.
- This part can only be used for a 16-bit device.

<Changing addresses>

Click on the check box for “Change all addresses in 1 group.” Then, in the address field, enter the start address for the part’s numeric display, and then change all the addresses.

**1 For each device’s two-word processing, please refer to the Device/PLC Connection Manual remarks in chapters 2-*3 and 5-*3, “Supported Devices”.*

17.10 Volume Switches Data Input Equipment OP4-LIB1.CPW

- When the arrow key or the display unit of the meter is touched, the volume is changed and data are set.
- There are horizontal, vertical, semicircular, and circular Volume Switches.
- This Part requires a ladder program. Refer to example 2 of the ladder program on the following page.

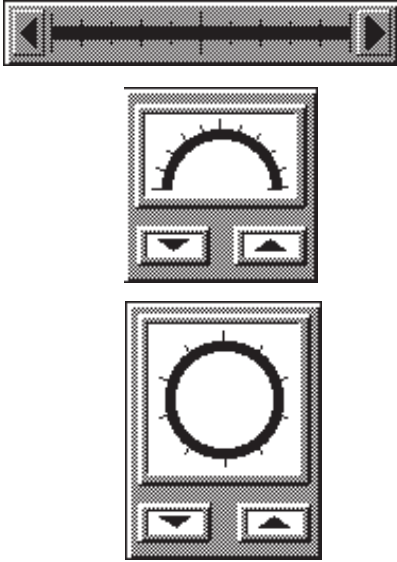
Part sample	Number and name of part
<p>Volume Switch</p> 	<p>45: Volume SW horizontal 46: Volume SW vertical</p> <p>47: Volume SW semicircular</p> <p>48: Volume SW circular</p>

In this section, a horizontal Volume SW is used as an example for explanation.

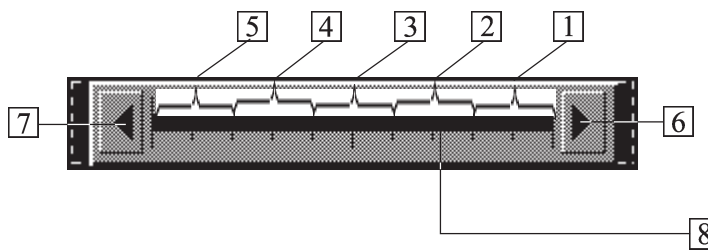

■ **Volume SW Dec**

Decimal data can be set to the specified word address.

Ex.) Volume SW horizontal

No.	Address	Function	Part Name	Description	Comment
1	D0000	Data Set	Word Switch	SW_ST100	When touched, the meter is indicated by 100%.
2	D0000	Data Set	Word Switch	SW_SET75	When touched, the meter is indicated by 75%.
3	D0000	Data Set	Word Switch	SW_SET50	When touched, the meter is indicated by 50%.
4	D0000	Data Set	Word Switch	SW_SET25	When touched, the meter is indicated by 25%.
5	D0000	Data Set	Word Switch	SW_SET0	When touched, the meter is indicated by 0%.
6	D0000	Addition/subtraction	Word Switch	SW_+1	Switch for adding to data one by one.
7	D0000	Addition/subtraction	Word Switch	SW_-1	Switch for subtracting to data one by one.
8	D0000	---	Bar Graph	BA_1	Displays on the monitor.

- The address is the initial value. It can be changed and used.
- The address occupies one word.



From 1 to 8, set the same address.

■ **Ladder program example #2**

In the case of 000 to 100 for Dec.

The ladder program indicates the method for controlling the upper limit and the lower limit.

(For Mitsubishi Electric MELSEC series)

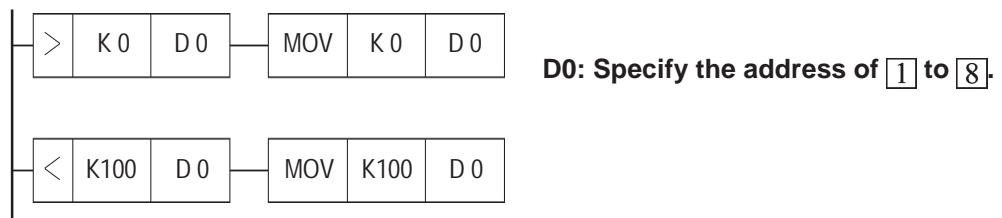

17.11 Numeric Input Keypad Data Input Equipment OP4-LIB1.CPW

- Numeric values which are touched and set are written into the word address in Dec or Hex.
- The Numeric Input Key is available as the Numeric Input Key Dec and the Numeric Input Key Hex

Part sample	Number and name of part
Numeric Input Key 	49: Numeric Input Key Dec 50: Numeric Input Key Hex

In this section, Numeric Input Key Dec and Hex are used as examples for explanation.

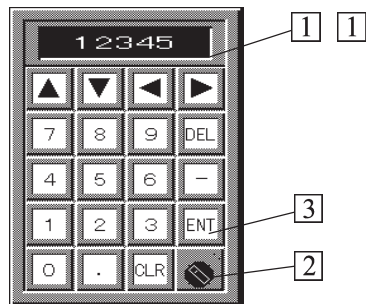

■ Numeric Input Key Dec

Dec data can be set to the specified word address.

Ex.) Numeric Input Key Dec

No.	Address	Function	Part Name	Description	Comment
[1]	LS050000	Trigger	Keypad Input Display	KD_1	Bit which enables setting to [1] '.
[2]	LS050000	Reverse (C)	Word Switch	SW_1	When touched, the switch enables setting to [1] '.
[2]	LS050000	Reverse (M)	Word Switch	SW_1	When touched, the switch enables setting to [1] ' . (reverse)
	Word address				
[1]	D0000	---	Keypad Input Display	KD_1	Displays the specified word address, and when touched [3], data are set.

- The address is the initial value. It can be changed and used.
- The address occupies one word.
- For asterisk "*" in [2], ID will change depending on the arrangement.



From [1] to [2], set the same address.

■ Numeric Input Key Hex

Hex data can be set to the specified word address.

Ex.) Numeric Input Key Hex

No.	Address	Function	Part Name	Description	Comment
[1]	LS050000	Trigger	Keypad Input Display	KD_1	Bit which enables setting to [1] ' .
[2]	LS050000	Reverse (C)	Switch	SW_1	When touched, the switch enables setting to [1] ' .
[2]	LS050000	Reverse (M)	Switch	SW_1	When touched, the switch enables setting to [1] ' . (reverse)
	Word address				
[1]	D0000	---	Keypad Input Display	KD_1	Displays the specified word address, and when touched [3], data are set.



- The address is the initial value. It can be changed and used.



- **From [1] to [2], set the same address.**
- **For asterisk "*" in [2], ID will change depending on the arrangement.**

17.12 LED Lamps Monitor Equipment Library Parts OP4-LIB2.CPW

- Turns on the Lamp in response to ON/OFF of the specified bit address.
- LED Lamps are available in the horizontal 4A type, vertical 4A type, horizontal 8A type, vertical 8A type, horizontal 4B type, vertical 4B type, horizontal 8B type, vertical 8B type, horizontal 4C type, vertical 4C type, horizontal 8C type, and vertical 8C type.

Part sample	Number and name of part
LED Lamp  Type A  Type B  Type C	1: LED Lamp horizontal 4A 2: LED Lamp vertical 4A 3: LED Lamp horizontal 8A 4: LED Lamp vertical 8A 5: LED Lamp horizontal 4B 6: LED Lamp vertical 4B 7: LED Lamp horizontal 8B 8: LED Lamp vertical 8B 9: LED Lamp horizontal 4C 10: LED Lamp vertical 4C 11: LED Lamp horizontal 8C 12: LED Lamp vertical 8C

Numeric values in the part name indicates the number of LEDs.

In this section, the LED Lamp horizontal 8A type is used as an example for explanation.

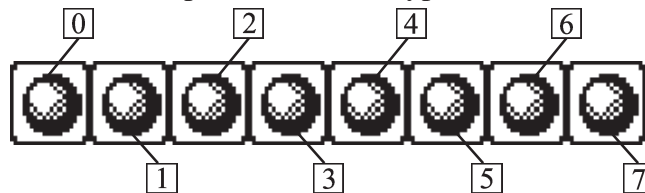

■ LED Lamp (Bit Address)

When the specified bit address is turned ON, the lamp goes on.

Ex.) LED Lamp horizontal 8A



No.	Address	Function	Part Name	Description	Comment
0	M0000	---	Lamp	LA_0	When the specified bit address is ON, 0 is turned on.
1	M0001	---	Lamp	LA_1	When the specified bit address is ON, 1 is turned on.
2	M0002	---	Lamp	LA_2	When the specified bit address is ON, 2 is turned on.
3	M0003	---	Lamp	LA_3	When the specified bit address is ON, 3 is turned on.
4	M0004	---	Lamp	LA_4	When the specified bit address is ON, 4 is turned on.
5	M0005	---	Lamp	LA_5	When the specified bit address is ON, 5 is turned on.
6	M0006	---	Lamp	LA_6	When the specified bit address is ON, 6 is turned on.
7	M0007	---	Lamp	LA_7	When the specified bit address is ON, 7 is turned on.



- **The address is the initial value. It can be changed and used.**
- **The addresses of the vertical type lamp are set in ascending order from the top.**
- **Do not use LED lamps of the horizontal 4A type, vertical 4A type, horizontal 8A type, vertical 8A type, horizontal 4C type, vertical 4C type, horizontal 8C type, and vertical 8C type for monochrome type of the GP series.**

17.13 I/O Monitor Monitor Equipment Library Parts OP4-LIB2.CPW

- The lamp is turned on in response to ON/OFF of the bit address of the touched switch.
- I/O monitor is available in the horizontal A type, horizontal A type with setup, vertical A type, vertical A type with setup, horizontal B type, horizontal B type with setup, vertical B type and vertical B type with setup.

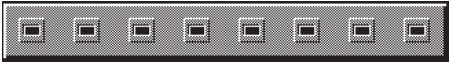
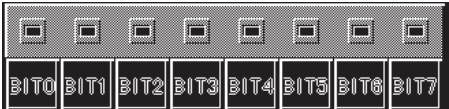
Part sample	Number and name of part
 <p>Horizontal A type</p>	13: I/O Monitor horiz. A 14: I/O Monitor horiz. A W/setup 15: I/O Monitor vert. A 16: I/O Monitor vert. A W/setup
 <p>Horizontal A type (with setup)</p>	
 <p>Horizontal B type</p>	17: I/O Monitor horiz. B 18: I/O Monitor horiz. B W/setup 19: I/O Monitor vert. B 20: I/O Monitor vert. B W/setup
 <p>Horizontal B type (with setup)</p>	

An example of I/O monitor with horizontal B setting is given here.

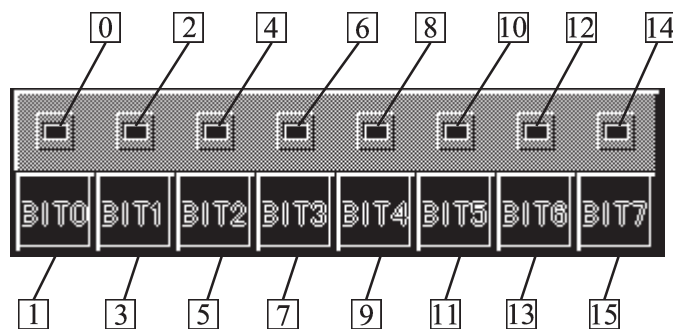

■ I/O Monitor (Bit Address)

Can be set to the specified bit address.

Ex.) I/O Monitor horiz. B W/setup

No.	Address	Function	Part Name	Description	Comment
0	M0000	---	Lamp	LA_0	The lamp goes on when 0 is touched.
1	M0000	Reverse (C)	Bit Switch	SW_0	The switch turns ON/OFF the specified bit address.
2	M0001	---	Lamp	LA_1	The lamp goes on when 2 is touched.
3	M0001	Reverse (C)	Bit Switch	SW_1	The switch turns ON/OFF the specified bit address.
4	M0002	---	Lamp	LA_2	The lamp goes on when 4 is touched.
5	M0002	Reverse (C)	Bit Switch	SW_2	The switch turns ON/OFF the specified bit address.
6	M0003	---	Lamp	LA_3	The lamp goes on when 6 is touched.
7	M0003	Reverse (C)	Bit Switch	SW_3	The switch turns ON/OFF the specified bit address.
8	M0004	---	Lamp	LA_4	The lamp goes on when 8 is touched.
9	M0004	Reverse (C)	Bit Switch	SW_4	The switch turns ON/OFF the specified bit address.
10	M0005	---	Lamp	LA_5	The lamp goes on when 10 is touched.
11	M0005	Reverse (C)	Bit Switch	SW_5	The switch turns ON/OFF the specified bit address.
12	M0006	---	Lamp	LA_6	The lamp goes on when 12 is touched.
13	M0006	Reverse (C)	Bit Switch	SW_6	The switch turns ON/OFF the specified bit address.
14	M0007	---	Lamp	LA_7	The lamp goes on when 14 is touched.
15	M0007	Reverse (C)	Bit Switch	SW_7	The switch turns ON/OFF the specified bit address.

- The address is the initial value. It can be changed and used.
- Addresses for vertical I/O Monitor are to be set from the top.



- **Set the same address to 0 to 1, 2 to 3, 4 to 5, 6 to 7, 8 to 9, 10 to 11, 12 to 13, 14 to 15.**
- **Do not use I/O monitor of the horizontal type A, horizontal A type with setup, vertical A type, vertical A type with setup for the monochrome type of the GP series.**

17.14 **Device Monitor** Monitor Equipment Library Parts OP4-LIB2.CPW

- Displays the data of the specified word address. When used with the Keypad and "SET" key is pressed, data can also be set to the address.
- The Device Monitor is available in the Device Monitor horizontal, Device Monitor horizontal with setup, Device Monitor vertical and Device Monitor vertical with setup.

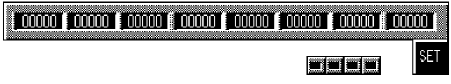
Part sample	Number and name of part
<p>Device Monitor</p>  <p>Horizontal type</p>  <p>Horizontal type with setup</p>	<p>21: Device Monitor horiz. 22: Device Monitor horiz. W/setup 23: Device Monitor Vert. 24: Device Monitor Vert. W/setup</p>

In this section, the Device Monitor horizontal with setup is used as an example for explanation.

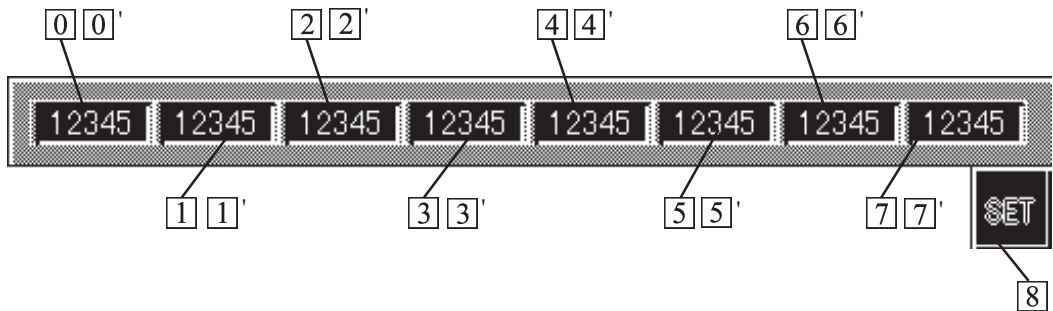

■ Device Monitor (Bit Address/Word Address)

It can be set to the specified word address.

Ex.) Device Monitor horiz. W/setup

No.	Address	Function	Part Name	Description	Comment
0	LS050000	Trigger	Keypad Input Display	KD_0	Bit which enables setting to 0 '.
1	LS050000	Trigger	Keypad Input Display	KD_1	Bit which enables setting to 1 '.
2	LS050000	Trigger	Keypad Input Display	KD_2	Bit which enables setting to 2 '.
3	LS050000	Trigger	Keypad Input Display	KD_3	Bit which enables setting to 3 '.
4	LS050000	Trigger	Keypad Input Display	KD_4	Bit which enables setting to 4 '.
5	LS050000	Trigger	Keypad Input Display	KD_5	Bit which enables setting to 5 '.
6	LS050000	Trigger	Keypad Input Display	KD_6	Bit which enables setting to 6 '.
7	LS050000	Trigger	Keypad Input Display	KD_7	Bit which enables setting to 7 '.
8	LS050000	Reverse (C)	Bit Switch	SW_SET	Switch which enables setting of 0 ' to 7 '.
	Word address				
0	D0000	---	Keypad Input Display	KD_0	Displays the data of the specified word address, and data from the keypad can be set.
1	D0001	---	Keypad Input Display	KD_1	
2	D0002	---	Keypad Input Display	KD_2	
3	D0003	---	Keypad Input Display	KD_3	
4	D0004	---	Keypad Input Display	KD_4	
5	D0005	---	Keypad Input Display	KD_5	
6	D0006	---	Keypad Input Display	KD_6	
7	D0007	---	Keypad Input Display	KD_7	

- The address is the initial value. It can be changed and used.
- When **0** to **7** are set to the same address, the cursor can be moved in ascending order of the ID name using the arrow key of the Keypad.



- **Set the same address to **0** to **8**.**
- **When placing out two or more Parts, change the address of the LS area for each Part. When the address is not changed, placed Parts perform the same operation.**

17.15 Timers Multifunction Equipment Library Parts OP4-LIB3.CPW

- The timer function of the PLC can be set. Use this function together with the Keypad. When "RESET" key is pressed, the set value can be entered by the Keypad.
- When the timer contact is turned ON, the lamp comes on.
- This part requires the ladder program. Refer to the example 3 of the ladder program on the following page.

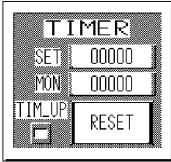
Part sample	Number and name of part
Timer 	1: Timer

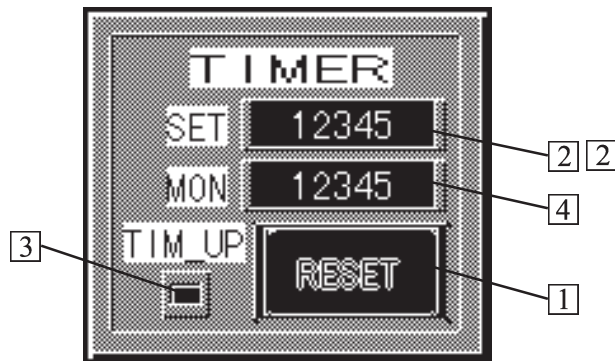

Ex.) Timer

No.	Address	Function	Part Name	Description	Comment
1	LS050000	Reverse (C)	Bit Switch	SW_RESET	When touched, the switch enables setting to 2.
1	LS050000	Reverse (M)	Bit Switch	SW_RESET	When touched, the switch enables setting to 2. (reverse)
2	LS050000	Trigger	Keypad Input Display	KD_SET	The switch enables setting to 2.
3	TS0000	---	Lamp	LA_TIMUP	When 2 and 4 are the same, the lamp comes on.
	Word address				
2	D0000	---	Keypad Input Display	KD_SET	Displays the set value to the specified word address, and the data from the keypad can be set.
4	TN0000	---	Numeric Display	NU_TIMER	Displays the current value of the timer.

- The address is the initial value. It can be changed and used.



- From to , set the same address.
- From to , set the same address.
- When placing two or more Parts, change the address of the LS area for each Part. When the address is not changed, placed Parts perform the same operation.

■ Ladder program example #3

(For a Mitsubishi Electric MELSEC series)

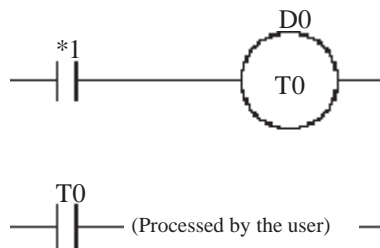

- *1: Specify any address as the one for starting the system.
- D0: Specify the address of .
- T0: Specify the address of and .

- The timer starting operates during the entry of *1 only.
- Measurement is taken until the value of T0 becomes the value of D0.
- When the measurement is completed, the contact of T0 is turned ON.

17.16 Counter Multifunction Equipment Library Parts OP4-LIB3.CPW

- The counter function of the PLC can be set. When using "PSET" key, use the Keypad together. When "RST" key is pressed, the current value of the counter is reset (to 0). When "PSET" key is pressed, the set value can be entered.
- When the contact of the counter is turned ON, the lamp comes on.
- Two types of counters are available; counter and counter with PSET function.
This part requires a ladder program. Refer to the example 4 of the ladder program on the following page.

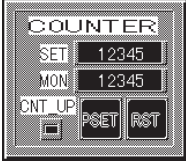
Part sample	Number and name of part
<p>Counter</p> 	<p>2: Counter 3: Counter W/PSET</p>

In this section, the Counter with PSET is used as an example for explanation.

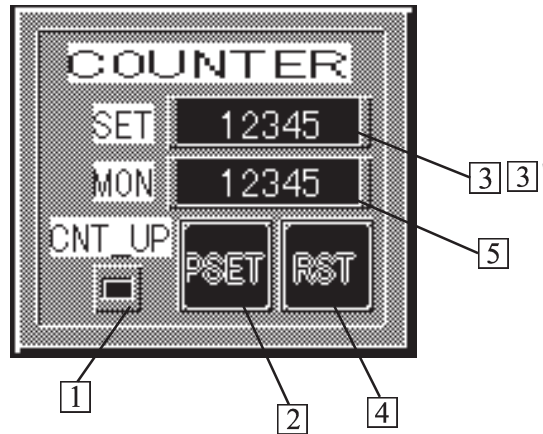

Ex.) Counter with PSET

No.	Address	Function	Part Name	Description	Comment
1	CS0000	---	Lamp	LA_CNTUP	When 3' and 5' are the same, the lamp comes on.
2	LS050000	Reverse (C)	Bit Switch	SW_PRSET	When touched, the switch enables setting to 3'.
2	LS050000	Reverse (M)	Bit Switch	SW_PRSET	When touched, the switch enables setting to 3' . (reverse)
3	LS050000	Trigger	Keypad Input Display	KD_SET	The switch enables setting to 3'.
4	M8000	Momentary (C)	Bit Switch	SW_RST	The switch for resetting the current value of the counter.
4	M8000	Momentary (M)	Bit Switch	SW_RST	The switch for resetting the current value of the counter. (reverse)
	Word address				
5	CN0000	---	Numeric Display	NU_COUNT	Displays the current value at the specified address.
3	D0000	---	Keypad Input Display	KD_SET	Displays the counter set value and sets the data through the Keypad.

- The address is the initial value. It can be changed and used.



- **With 2, 2 and 3, enter the same address.**
- **With 4 and 4, enter the same address.**
- **With 1 and 5, enter the same address.**
- **When placing two or more Parts, change the address of the LS area for each Part. When the address is not changed, placed Parts perform the same operation.**

■ Ladder program example #4

(For a Mitsubishi Electric MELSEC series)

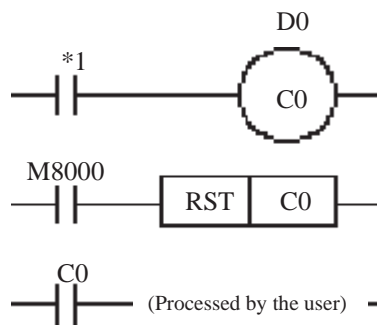

- ***1:** Specify any address as the one for starting the system.
- **D0:** Specify the address of 3.
- **C0:** Specify the address of 1 and 5.
- **M8000:** Specify the address of 4.

- Counts the number of start-up when *1 is entered.
- When it turns to D0, C0 is turned ON.
- When M8000 (to be matched to the contact of RST key) is entered, the current value of the counter is reset.

17.17 Heat Control Multifunction Equipment Library Parts OP4-LIB3.CPW

- Data of the Heat Control can be set. Use the Keypad for setting.
- Two types of Heat Controls are available: Flexible Heat Control and Multifunction Heat Control.

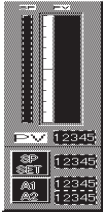
Part sample	Number and name of part
Heat Control 	4: Flexible Heat Control 5: Multifunction Heat Control

In this section, the Flexible Heat Control is used as an example for explanation.

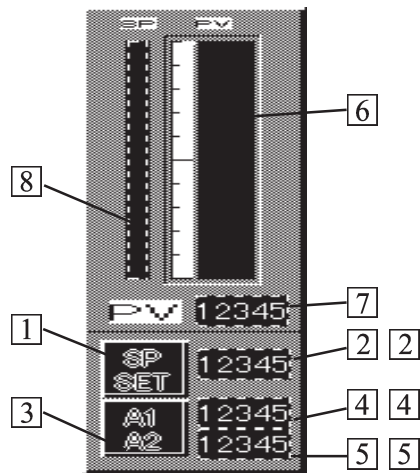

Ex.) Flexible Heat Control

No.	Address	Function	Part Name	Description	Comment
1	LS050000	Reverse (C)	Bit Switch	SW_SPSET	When touched, the switch enables setting to 2'.
1	LS050000	Reverse (M)	Bit Switch	SW_SPSET	When touched, the switch enables setting to 2' . (reverse)
2	LS050000	Trigger	Keypad Input Display	KD_SPSET	The switch enables setting to 2' .
3	LS050001	Reverse (M)	Bit Switch	SW_A1, A2	When touched, the switch enables setting to 4' and 5' . (reverse)
3	LS050001	Reverse (C)	Bit Switch	SW_A1, A2	When touched, the switch enables setting to 4' and 5' .
4	LS050001	Trigger	Keypad Input Display	KD_A1	The switch enables setting to 4' .
5	LS050001	Trigger	Keypad Input Display	KD_A2	The switch enables setting to 5' .
	Word Address				
6	D0000	---	Bar Graph	BA_PV	Displays the data of the specified word address on the bar graph. (Current value)
7	D0000	---	Keypad Input Display	NU_PV	Displays the numeric value of the data of the specified word address. (Current value)
4	D0001	---	Keypad Input Display	KD_A1	Displays the data of the specified word address, and the data can be set from the Keypad. (Maximum value)
5	D0002	---	Keypad Input Display	KD_A2	Displays the data of the specified word address, and the data can be set from the Keypad. (Minimum value)
2	D0010	---	Keypad Input Display	KD_SPSET	Displays the data of the specified word address, and the data can be set from the Keypad. (Target value)
8	D0010	---	Bar Graph	BA_SP	Displays the data of the specified word address on the bar graph. (Target value)

- The address is the initial value. It can be changed and used.



- **From 1 to 3, set the same address.**
- **From 6 to 7, set the same address.**
- **When placing two or more Parts, change the address of the LS area for each Part. When the address is not changed, placed Parts the same operation.**

In this section, the Multifunction Heat Control is used as an example for explanation.

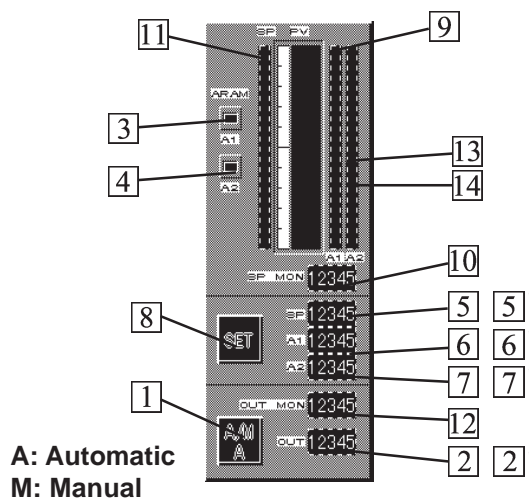

Specification for the Multifunction Heat Control is exclusive to UT series of Yokogawa Electric.

Ex.) Multifunction Heat Control

Specification for the Multifunction Heat Control is exclusive to UT series of Yokogawa Electric.

No.	Address	Function	Part Name	Description	Comment
1	1D060700	Reverse (C)	Bit Switch	SW_A/M	The switch which can select either manual setting or automatic setting of the output value. In manual setting mode, data can be set to 2.
1	1D060700	Reverse (M)	Bit Switch	SW_A/M	The switch which can select either manual setting or automatic setting of the output value. In manual setting mode, data can be set to 2. (reverse)
2	1D060700	Trigger	Keypad Input Display	KD_OUT	The bit which can set data to 2 (output value) when 1 is the manual setting.
3	1I0101	---	Lamp	LA_A1	Comes on when the current value becomes the maximum value.
4	1I0105	---	Lamp	LA_A2	Comes on when the current value becomes the minimum value.
5	LS050000	Trigger	Keypad Input Display	KD_SP	The switch enables setting to 5. (Target value)
6	LS050000	Trigger	Keypad Input Display	KD_A1	The switch enables setting to 6. (Maximum value)
7	LS050000	Trigger	Keypad Input Display	KD_A2	The switch enables setting to 7. (Minimum value)
8	LS050000	Reverse (C)	Bit Switch	SW_SET	The switch which can enter the target set value 5, maximum value 6 and minimum value 7.
8	LS050000	Reverse (M)	Bit Switch	SW_SET	The switch which can enter the target set value 5, maximum value 6 and minimum value 7. (reverse)
	Word address				
9	ID0006	---	Bar Graph	BA_PV	Displays the data of the specified word address on the bar graph. (Current value)
10	ID0010	---	Numeric Display	NU_SPMON	Displays the numeric value of the data of the specified word address. (Target value)
11	ID0010	---	Bar Graph	BA_SP	Displays the data of the specified word address on the bar graph. (Target value)
12	ID0014	---	Numeric Display	NU_OUTMN	Displays the numeric value of the data of the specified word address. (Output value)
5	ID0100	---	Keypad Input Display	KD_SP	Displays the data of the specified word address, and the data can be set from the Keypad. (Target value)
6	ID0111	---	Keypad Input Display	KD_A1	Displays the data of the specified word address, and the data can be set from the Keypad. (Maximum value)
13	ID0111	---	Bar Graph	BA_A1	Displays the data of the specified word address on the bar graph. (Maximum value)
7	ID0112	---	Keypad Input Display	KD_A2	Displays the data of the specified word address, and the data can be set from the Keypad. (Minimum value)
14	ID0112	---	Bar Graph	BA_A2	Displays the data of the specified word address on the bar graph. (Minimum value)
2	ID0609	---	Keypad Input Display	KD_OUT	Displays the data of the specified word address, and the data can be set from the Keypad. (Output value)

17.18

Add/Subtract Momentary Switch Application Library OP4-LIB4.CPW

The current value in the PLC's word address can be increased or decreased using these two touch keys. These touch keys are momentary switches.

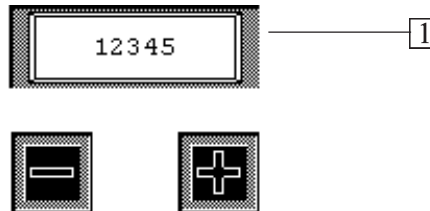
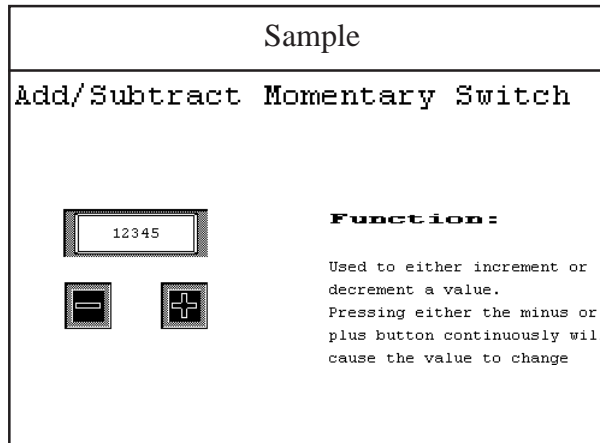

■ **Parts**

No.	Address	Part Name	Description	Comment
1	LS0500	Numeric Display	ND_MONI	Displays the current (numeric) data stored in address LS0500.

■ Tag





No.	Tag Name	Starting Bit Address	Word Address	Word Address 1	Comment
2	W+	---	LS0500	LS0500	Tag for increasing value in LS0500.
3	W-	---	LS0500	LS0500	Tag for decreasing value in LS0500.
4	WCP+	LS203800	---	---	Controls the addition cycle speed.
5	WCMP-	LS203800	---	---	Controls the subtraction cycle speed.

The address provides the initial value, and can be used without being changed. When changing the address, please pay attention to the following items:



- **To change addresses used to store data to be added and subtracted, change addresses 1 to 3. However, be sure to change all of them so they are the same number.**
- **Changing data addresses 4 and 5, adjusts the addition and subtraction cycle speeds from LS203800 to LS203815. Here, the more an address value is increased, the slower the cycle becomes.**
- To change a part's setting data, double-click on that Part.
- To change a tag's setting data, click on the Menu Bar's View selection to bring up the pull-down menu. Then, select [Tag List] and change the tag's settings.
- Last, use [Ungroup] to remove any unnecessary characters or items from the screen.

17.19 Window Display Tool Application Library OP4-LIB4.CPW

- The  and  keys are used to increase or decrease the window's registration number, and the  key is used to either display or hide the window.
- Also, the  key is available for moving the window in any direction.

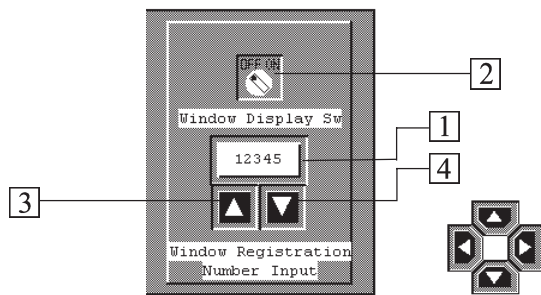
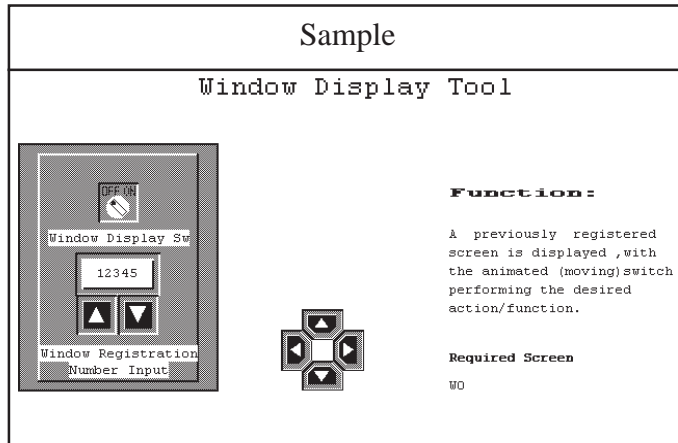

■ **Parts**

No.	Address	Function	Part Name	Description	Comment
1	LS501	---	Numeric Display	ND_MONI	Displays the window's registration number.
2	LS050000	Reverse (C)	Bit Switch	BS_001	Toggles between displaying or hiding the display.
3	LS0501	Addition/subtraction	Word Switch	WS_+	Increases the window registration number.
4	LS0501	Addition/subtraction	Word Switch	WS_-	Decreases the window registration number.

■ Tag

No.	Tag name	Word address	Word address 1	Comment
5	U0000	LS0500	---	Displays the window.
6	WX+	LS0502	LS0502	Moves the display window one direction on the X axis.
7	WX-	LS0502	LS0502	Moves the display window one direction on the X axis.
8	WY-	LS0503	LS0503	Moves the display window one direction on the Y axis.
9	WY+	LS0503	LS0503	Moves the display window one direction on the Y axis.

The address provides the initial value, and can be used without being changed. When changing the address, please pay attention to the following items:



- **For numbers 2 and 5, use these to the same address.**
 - **For numbers 1, 3, and 4, use an address created by adding 1 to address 5.**
 - **For numbers 6 and 7, use an address created by adding 2 to address 5.**
 - **For numbers 8 and 9, use an address created by adding 3 to address 5.**
- To change a part's setting data, double-click on that Part.
 - To change a tag's setting, click on the Menu Bar's View selection to bring up the pull-down menu. Then, select [Tag List] and change the tag's settings.
 - Lastly, use [Ungroup] to remove any unnecessary characters or items from the screen.

17.20 2 Button Safety Switch Application Library OP4-LIB4.CPW

- If switches [1] and [2] are pressed simultaneously, the bit will be set to ON.

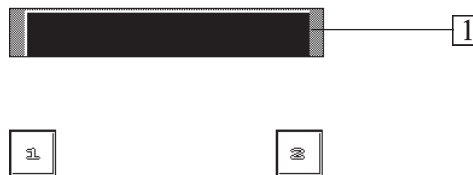
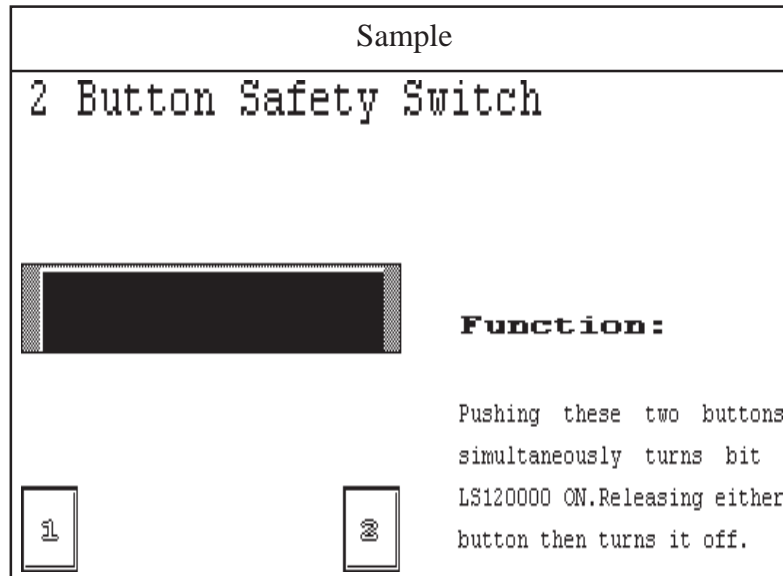

■ **Parts**

No.	Address	Part Name	Description	Comment
1	LS1200	Message Display	ME_MONI	Can confirm whether both switches are pressed.

■ Tag

No.	Tag Name	Bit Address	Word Address 1	Comment
2	W1	LS120000	LS1100	Displays confirmation that both switches are pressed.
3	W2	LS120001	LS1100	Indicates that switch [1] has not been pressed.
4	W3	LS120002	LS1100	Indicates that switch [2] has not been pressed.

The address provides the initial value, and can be used without being changed. When changing the address, please pay attention to the following items:

- When modifying an address that you want the action of pressing both switches to turn ON, change W1 tag (#2 above)'s LS120000.
- To change a tag's setting, click on the Menu Bar's View selection to bring up the pull-down menu. Then, select [Tag List] and change the tag's settings.
- Lastly, use [Ungroup] to remove any unnecessary characters.
- If the confirmation message display is not needed, delete numbers 1, 3, and 4 .

17.21 Alarm Display #1 Application Library OP4-LIB4.CPW

- Messages are displayed by turning the monitor bit ON and OFF.
- You can display a detailed explanation of an alarm message (text screen) in the sub-screen by first, using the **Up** or **Down** key to highlight a specific message, and then pressing the **Ok** key.

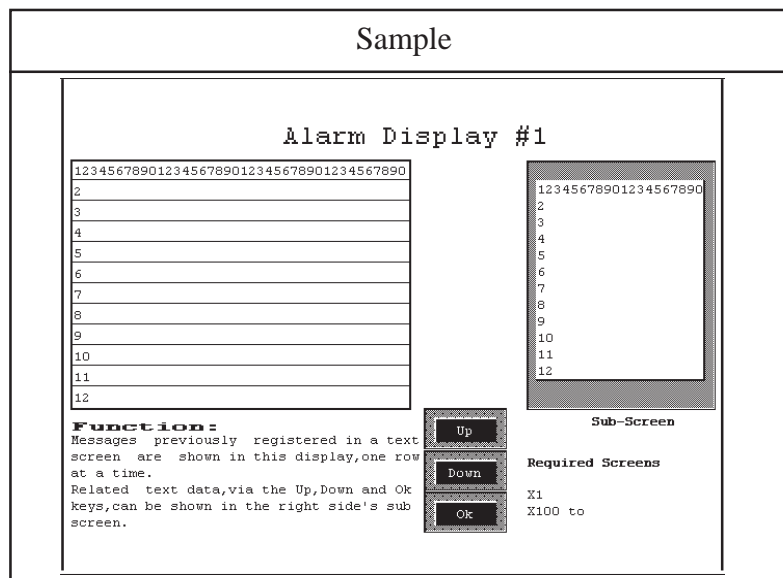

■ Tag

No.	Tag Name	Word Address	Word Address 1	Comment
1	A	LS1000	LS1100	Messages are displayed by turning the monitor bit ON.

The address provides the initial value, and can be used without being changed. When changing the address, please pay attention to the following items.

Reference For details, refer to "A-tag" in the Tag Reference Manual.

- When you want to change an alarm's monitor bit, change Tag #1's LS1000.
- Create an alarm message on the X1 text screen that is 40 half-sized characters (20 full-sized) x 16 lines. (At any one time, a maximum of 12 lines can be displayed.) Each line of text entered corresponds to a single bit in word address LS1000. For example, LS1000's LS100000 address is used to control the first line of X1's data, LS100001 controls the second line of data, and so on.
- Create detailed alarm data explanations on screen's X100 to X115 These text screens are 20 half-sized characters (10 full-sized) x 12 lines. Thus, details about LS100000's alarm are explained on X100 screen, details of LS100001's alarm are explained on X101 screen, etc.
- To change a tag's setting, click on the Menu Bar's View selection to bring up the pull-down menu. Then, select [Tag List] and change the tag's settings.
- Lastly, use [Ungroup] to remove any unnecessary characters or items from the screen.

17.22 Alarm Display #2 Application Library OP4-LIB4.CPW

- Messages are displayed by turning the monitor bit ON and OFF.
- A Library (base screen)'s sub-screen information can be called up by pressing the **Up** or **Down** key to select a specific message, and then pressing the **Ok** key.

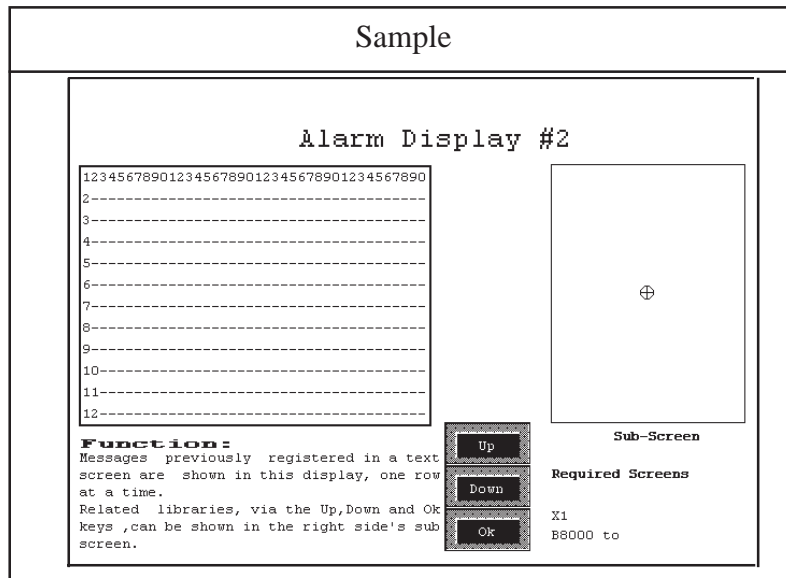

■ **Tag**

No.	Tag Name	Word Address	Word Address 1	Comment
1	A	LS1000	LS1100	Messages are displayed by turning the monitor bit ON.

The address provides the initial value, and can be used without being changed. When changing the address, please pay attention to the following items.

Reference For details, refer to "A-tag" in the Tag Reference Manual.

- When you want to change the monitor bit of an alarm, change Word Address LS1000.
- Create an alarm message on the X1 text screen that is 40 half-sized (20 full-sized) characters x 16 lines. (At any one time, a maximum of 12 lines can be displayed). Each line of text entered corresponds to a single bit in word address LS1000. For example, LS1000's LS100000 address is used to control the first line of X1's data, LS100001 controls the second line of data, and so on.
- Use Base screen's B8000 to B8015 to create detailed explanations. However, be sure to use coordinates that are within +90 dots in the X direction, and +120 dots in the Y direction of the center of the screen. Thus, details about LS100000's alarm are explained on B8000 screen, details of LS100001's alarm are explained on B8001 screen, etc.
- To change a tag's setting, click on the Menu Bar's View selection to bring up the pull-down menu. Then, select [Tag List] and change the tag's settings.
- Lastly, use [Ungroup] to remove any unnecessary characters or items from the screen.

17.23 Alarm Display #3 Application Library OP4-LIB4.CPW

- Messages are displayed by turning the monitor bit ON and OFF.
- This Alarm screen is displayed via a Q-tag's Active display.

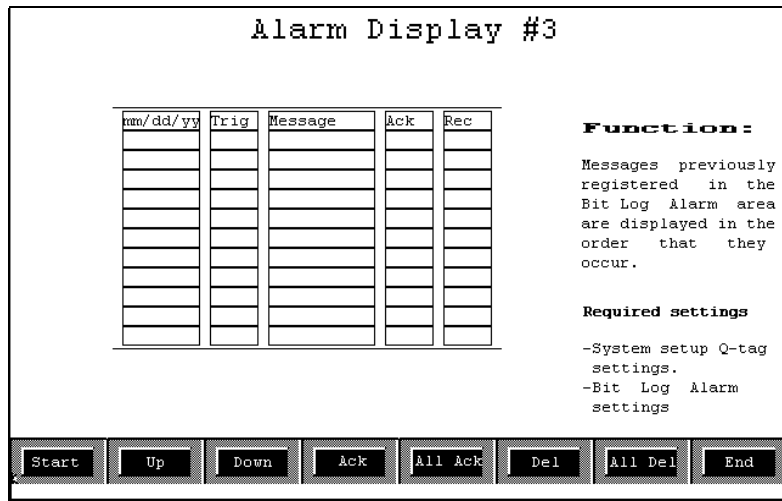

■ **Tag**

No.	Tag Name	Digits Displayed	Lines Displayed	Comment
1	Q	40	12	Messages are displayed in the order that the alarm summary monitor bits are turned on.

- Alarm messages must be created with the function menu's [Create/Edit Alarm] feature. Be sure to set a monitor bit when creating each [Bit Log Alarm Message].
- Be sure to change the above mentioned tag example (#1)'s "Digits Displayed" number, depending on the length of your alarm message.
- To change either the time or message's display format, use the [GP System Setup]'s [Initial Screen Setup] screen.
- To change a tag's setting, click on the Menu Bar's View selection to bring up the pull-down menu. Then, select [Tag List] and change the tag's settings.
- Lastly, use [Ungroup] to remove any unnecessary characters or items from the screen.

17.24 Active Image Display Tool Application Library OP4-LIB4.CPW

- By displaying a series of related screens, an image screen becomes animated.

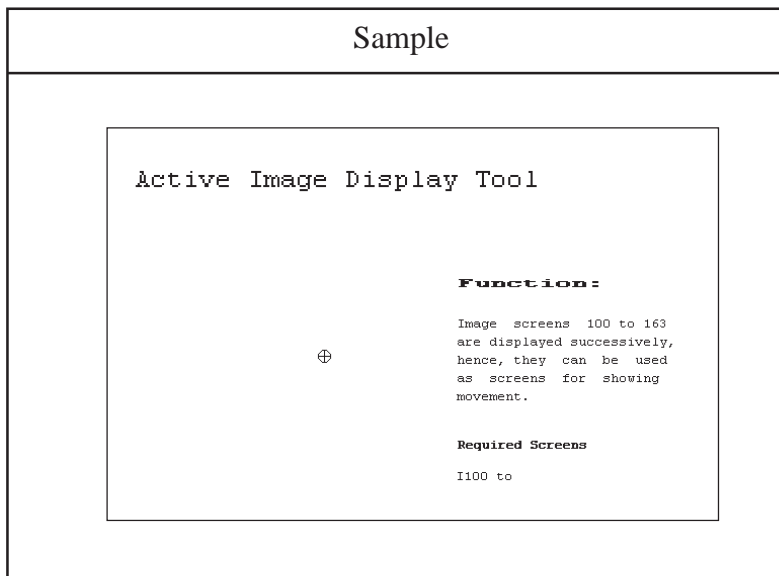

■ **Tag**





No.	Tag Name	Word Address	Bit Length	Starting Screen Number	Screen Type	Comment
1	L	LS2038	6	100	Image screen	Displays image screens 100 to 163 in sequence.

The address provides the initial value, and can be used without being changed. The address is specified in the LS2038 tag scan counter. The image screens are changed to display screens in succession, giving the appearance of animation, every time the tag is scanned. When changing the address, please pay attention to the following items.

Reference For details, refer to "**L-tag**" in the Tag Reference Manual.

- To select a different screen change speed, change Word Address LS2038.
- Prepare the image screens (numbers 100 to 163) to be used for animation.
- When more than 64 image screens are used, be sure to increase the above mentioned example #1's bit length setting.
- When the first image screen used is either greater or less than 100, be sure to change the starting screen number.
- When using animation on a base screen, be sure to change the designated screen type 1.
- To change a tag's setting, click on the Menu Bar's View selection to bring up the pull-down menu. Then, select [Tag List] and change the tag's settings.
- Lastly, use [Ungroup] to remove any unnecessary characters or items from the screen.

17.25 Filing Data Edit Tool Application Library OP4-LIB4.CPW

- This application enables you to check and edit the filing data stored in backup SRAM. To do this, you will need to transfer the data to the LS area using the  key, which will allow you to check and edit the data shown on the Keypad Input Display . If you wish to edit the data during this step, you will need to call up a ten-keypad and enter the new data, then transfer the new data to PLC using the  key.
- When you wish to change the data you have already transferred to the PLC, use  key to send the data back to the LS area. In order to back up the data, use the  key to transfer the newly entered data to SRAM.

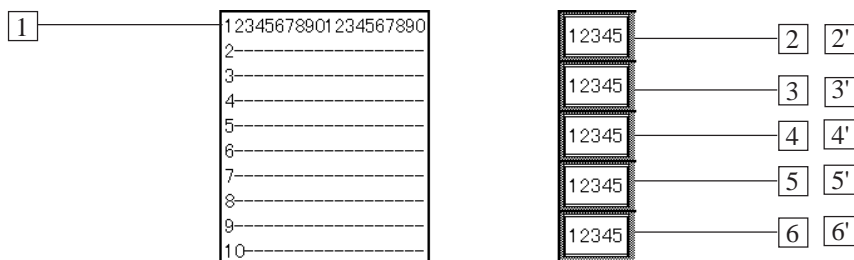
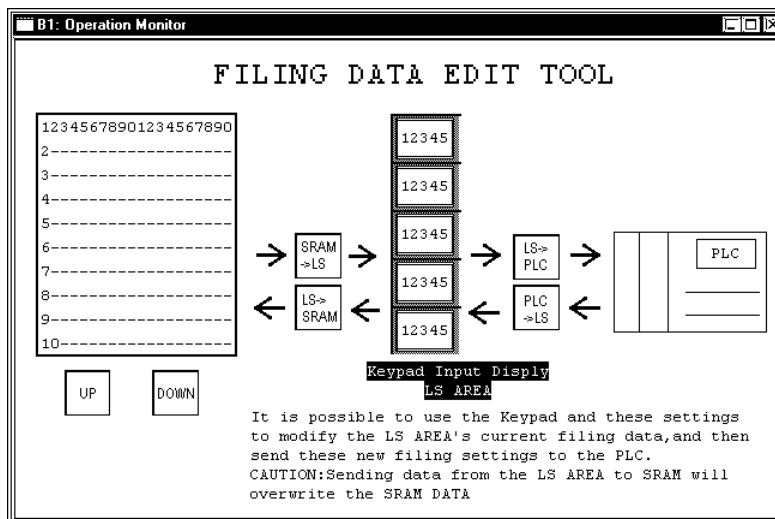

Parts

No.	Word Address	Function	Part Name	Comment
1	LS0020	-	Filing Data Display	Start Word Address of the stored LS area data.
2	LS0036	Data Storage Address	Keypad Input Displays	Word Address which indicates the first piece of word data written in the LS area.
3	LS0037	Data Storage Address	Keypad Input Displays	Word Address which indicates the second piece of word data written in the LS area.
4	LS0038	Data Storage Address	Keypad Input Displays	Word Address which indicates the third piece of word data written in the LS area.
5	LS0039	Data Storage Address	Keypad Input Displays	Word Address which indicates the fourth piece of word data written in the LS area.
6	LS0040	Data Storage Address	Keypad Input Displays	Word Address which indicates the fifth piece of word data written in the LS area.

■ **Parts**

No.	Word Address	Function	Parts Name	Comments
2'	X00000	Start Bit Address	Keypad Input Displays	When combined with a keypad, used to enter the Start Bit Address.
3'	X00000	Start Bit Address	Keypad Input Displays	When combined with a keypad, used to enter the Start Bit Address.
4'	X00000	Start Bit Address	Keypad Input Displays	When combined with a keypad, used to enter the Start Bit Address.
5'	X00000	Start Bit Address	Keypad Input Displays	When combined with a keypad, used to enter the Start Bit Address.
6'	X00000	Start Bit Address	Keypad Input Displays	When combined with a keypad, used to enter the Start Bit Address.



- **When you wish to use the Filing Data Edit Tool, select [Filing data] from [Project], and select [Filing Settings]. Then, check the [Filing (ON/OFF)]check box and enter the address.**

Reference Tag Reference Manual 4.2 Filing Data (Recipe) Function

- **This Application Library's Parts are made to be used with 16 bit devices. If you wish to use 32 bit devices, you need to change addresses.**

Reference Tag Reference Manual 4.2 Filing Data (Recipe) Function

- Addresses are factory set and can be used as they are.
- For details of the LS area's structure, refer to the "Tag Reference Manual"

Reference Tag Reference Manual 4.2 Filing Data (Recipe) Function

< **How to change addresses** >

Click on the [Address Range Conversion] check box to select it. Enter the start address in Filing Data Display Part's address, and convert the address.

17.26 Logging Keypad-Decimal Application Library OP4-LIB4.CPW

- This keypad is designed to be used for changing GP logging data values. Click on the [Logging Display]'s [Data Edit] feature so that after data is sent to the GP, you will be able to change displayed data values by simply touching inside their display area. Combining this feature with the keypad shown here will allow you to easily edit data while it is displayed on the GP.

Reference Tag Reference Manual 4.3 Logging Function

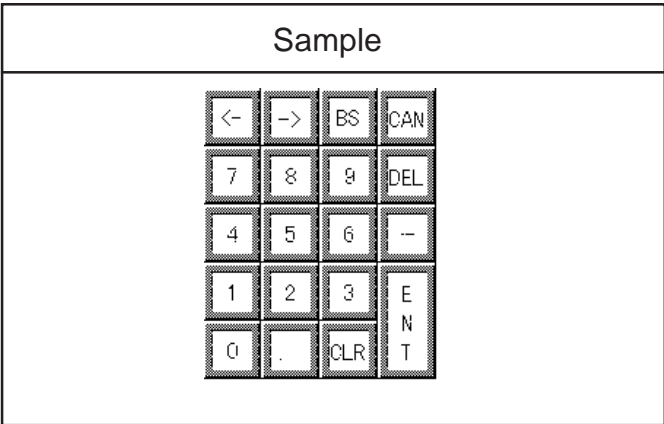

17.27**Logging Keypad-Hex Application Library** OP4-LIB4.CPW

- This keypad is designed to be used for changing GP logging data values. Click on the [Logging Display]'s [Data Edit] feature so that after data is sent to the GP, you will be able to change displayed data values by simply touching inside their display area. Combining this feature with the keypad shown here will allow you to easily edit data while it is displayed on the GP.

Reference *Tag Reference Manual 4.3 Logging Function*

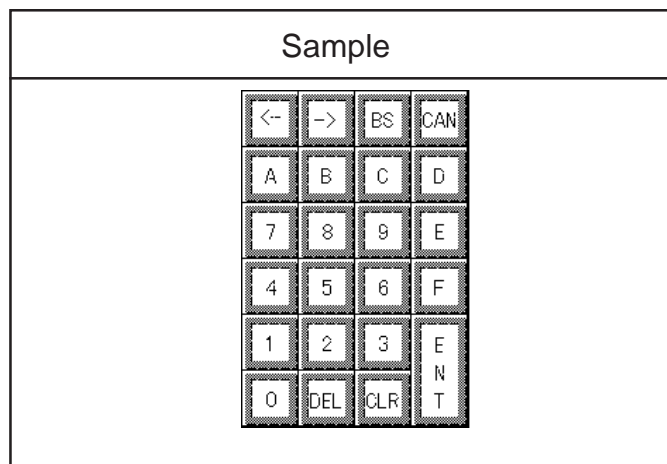

18 Mark Libraries

- 1 What is the Mark Library
- 2 Configuration of the MRK File
- 3 Reading the Mark List

18.1 What is the Mark Library

A pre-made ISO standard Mark (MRK) file is included in this software. When this file is opened, the list of marks (library) is displayed. It is possible to read marks from the mark library or to register the marks generated in the mark generation area into the library (list).

Reference *For a detailed explanation, refer to the GP-PRO/PB III for Windows Operation Manual's section "3.1.4 Registering and Placing a Mark Library Item".*

18.2 Configuration of the MRK File

Graphic symbols of ISO7000 series are provided. Refer to the following table and open a file.

No. of graphic symbol	MRK file name	Title
0001-0200	ISO7-1.MRK	0001-0200
0201-0400	ISO7-2.MRK	0201-0400
0401-0600	ISO7-3.MRK	0401-0600
0601-0800	ISO7-4.MRK	0601-0800
0801-1000	ISO7-5.MRK	0801-1000
1001-1140	ISO7-6.MRK	1001-1140

18.3 Reading the Mark List

From next page on, the lists of registered marks are shown on left pages, and the tables of symbol numbers on right pages. In this section, how to read the table and items of the table are explained.

Ex.) Indicates the title of MRK file. Indicates MRK filename.

18.1
Symbol
0001-0050
ISO7-1.MRK

0001	0002	0003	0004	0005	0006	0007	0008	0009	0010
0011	0012	0013	0014	0015	0016	0017	0018	0019	0020
0021	0022	0023	0024	0025	0026	0027	0028	0029	0030
0031	0032	0033	0034	0035	0036	0037	0038	0039	0040
0041	0042	0043	0044	0045	0046	0047	0048	0049	0050

Symbol No.s list

Symbol No.	Referent	Symbol No.	Referent
0001	Limited rectilinear motion	0026	Automatic cycle; semi-automatic cycle
0002	Limited rectilinear motion and return	0027	Cooling
0003	Limited reciprocating rectilinear motion (continuous)	0028	Filling
0004	Direction of continuous rotation	0029	Draining; emptying
0005	Rotation in two directions	0030	Overflow
0006	Limited rotation	0031	Lubrication
0007	Limited rotation and return	0032	Blowing
0008	Oscillating rotary movement (continuous)	0033	Suction
0009	One revolution	0034	Temperature
0010	Number of revolutions per minute; rotational speed	0035	Increasing temperature
0011	Electric motor	0036	Decreasing temperature
0012	Gear drive	0037	Wind (continuous material); roll (continuous material)
0013	Belt drive	0038	Unwind (continuous material); unroll (continuous material)
0014	Chain drive	0039	Fold (continuous material)
0015	Coupling	0040	Adjust guide width at entry
0016	Cam	0041	Adjust right-hand entry guide
0017	Automatic control (closed loop)	0042	Adjust left-hand entry guide
0018	Lock; tighten	0043	Passage of continuous material over driven roller
0019	Unlock; unclamp	0044	Selvedge guiding
0020	Brake on	0045	Selvedge uncurling
0021	Brake off	0046	Cloth expander
0022	Engaging; mechanical activation	0047	Change direction of continuous material
0023	Disengaging; mechanical deactivation	0048	Wet bow correction (selvedge advanced)
0024	Open (a container)	0049	Wet bow correction (selvedge advanced centre retained)
0025	Close (a container)	0050	Skew correction -- right-hand selvedge

Graphic symbol numbers are shown in the left side of the table.

The graphic symbol number is assigned corresponding to each of the mark.

Before using the mark, confirm the number against the mark list shown in the next section.

18.4 **Symbol No.s** **0001-0050** ISO7-1.MRK

0001	0002	0003	0004	0005	0006	0007	0008	0009	0010
0011	0012	0013	0014	0015	0016	0017	0018	0019	0020
0021	0022	0023	0024	0025	0026	0027	0028	0029	0030
0031	0032	0033	0034	0035	0036	0037	0038	0039	0040
0041	0042	0043	0044	0045	0046	0047	0048	0049	0050









Symbol No.	Referent	Symbol No.	Referent
0001	Limited rectilinear motion	0026	Automatic cycle; semi-automatic cycle
0002	Limited rectilinear motion and return	0027	Cooling
0003	Limited reciprocating rectilinear motion (continuous)	0028	Filling
0004	Direction of continuous rotation	0029	Draining; emptying
0005	Rotation in two directions	0030	Overflow
0006	Limited rotation	0031	Lubrication
0007	Limited rotation and return	0032	Blowing
0008	Oscillating rotary movement (continuous)	0033	Suction
0009	One revolution	0034	Temperature
0010	Number of revolutions per minute; rotational speed	0035	Increasing temperature
0011	Electric motor	0036	Decreasing temperature
0012	Gear drive	0037	Wind (continuous material); roll (continuous material)
0013	Belt drive	0038	Unwind (continuous material); unroll (continuous material)
0014	Chain drive	0039	Fold (continuous material)
0015	Coupling	0040	Adjust guide width at entry
0016	Cam	0041	Adjust right-hand entry guide
0017	Automatic control (closed loop)	0042	Adjust left-hand entry guide
0018	Lock; tighten	0043	Passage of continuous material over driven roller
0019	Unlock; unclamp	0044	Selvedge guiding
0020	Brake on	0045	Selvedge uncurling
0021	Brake off	0046	Cloth expander
0022	Engaging; mechanical activation	0047	Change direction of continuous material
0023	Disengaging; mechanical deactivation	0048	Weft bow correction (selvedge advanced)
0024	Open (a container)	0049	Weft bow correction (selvedge advanced centre retained)
0025	Close (a container)	0050	Skew correction -- right-hand selvedge

18.5 **Symbol No.s** **0051-0100** ISO7-1.MRK

0051	0052	0053	0054	0055	0056	0057	0058	0059	0060
0061	0062	0063	0064	0065	0066	0067	0068	0069	0070
0071	0072	0073	0074	0075	0076	0077	0078	0079	0080
0081	0082	0083	0084	0085	0086	0087	0088	0089	0090
0091	0092	0093	0094	0095	0096	0097	0098	0099	0100

Symbol No.	Referent Symbol No.	Referent	Referent
0051	Skew correction -- left-hand selvedge	0076	Beginning of reel
0052	Cutting of material at centre	0077	Original difficult to read
0053	Multiple cutting of material	0078	Damaged text; wrong binding
0054	Cut [trim] edges of continuous material	0079	Incorrect numbering; incorrect date
0055	Suction removal of trimmed edges	0080	Repetition of image
0056	Reinforcement [stiffening] of edges	0081	Missing pages [issues]
0057	Opening of selvedge loops	0082	High beam; upper beam
0058	Entry control	0083	Low beam; dipped beam
0059	Delivery control	0084	Turn signals
0060	Seam guide	0085	Hazard warning
0061	Straining element; clip	0086	Windscreen wiper
0062	Clip cleaner	0087	Windscreen wiper and washer
0063	Edge pin; pin plate	0088	Windscreen washer
0064	Overfeed pinning	0089	Ventilating and air-circulating fan
0065	Clean edge pins [pin plates]	0090	Loading and ejection
0066	Increase width	0091	Track change
0067	Reduce width	0092	Tuning alignment
0068	Width adjustment	0093	Remote control
0069	Shear; crop	0094	Control; controlling
0070	Brushing by means of a rotating brush	0095	Feedback control
0071	Brushing by means of a brush belt	0096	Manual control
0072	Cleaning of tracks	0097	Rear window wiper
0073	Spraying	0098	Rear window wiper and washer
0074	Raise and lower trough	0099	Rear window washer
0075	End of reel	0100	Provision for the disabled [handicapped persons]

18.6 **Symbol No.s** **0101-0150** ISO7-1.MRK

0101	0102	0103	0104	0105	0106	0107	0108	0109	0110
									
0111	0112	0113	0114	0115	0116	0117	0118	0119	0120
									
0121	0122	0123	0124	0125	0126	0127	0128	0129	0130
0131	0132	0133	0134	0135	0136	0137	0138	0139	0140
									
0141	0142	0143	0144	0145	0146	0147	0148	0149	0150

Symbol No.	Referent	Symbol No.	Referent
0101		0126	
0102		0127	
0103		0128	
0104		0129	
0105		0130	
0106		0131	Agitator, general
0107		0132	
0108		0133	
0109		0134	Pump; liquid pump
0110	Heat exchanger with cross-flow	0135	Centrifugal pump
0111	Heat exchanger without cross-flow	0136	
0112		0137	Compressor; vacuum pump
0113		0138	Rotary compressor, liquid-ring type, vacuum pump, liquid-ring type
0114	Filter; filter vessel; strainer	0139	
0115		0140	
0116		0141	
0117		0142	
0118		0143	
0119		0144	
0120		0145	
0121		0146	
0122		0147	
0123		0148	
0124		0149	
0125		0150	

18.7 **Symbol No.s** **0151-0200** ISO7-1.MRK

0151	0152	0153	0154	0155	0156	0157	0158	0159	0160
0161	0162	0163	0164	0165	0166	0167	0168	0169	0170
0171	0172	0173	0174	0175	0176	0177	0178	0179	0180
0181	0182	0183	0184	0185	0186	0187	0188	0189	0190
0191	0192	0193	0194	0195	0196	0197	0198	0199	0200

Symbol No.	Referent	Symbol No.	Referent
0151	Headlamp levelling control	0176	Level control
0152		0177	Weft adjusting; stitch row straightening
0153		0178	Weft control; stitch row feeler
0154		0179	Roller engaged
0155		0180	Roller disengaged
0156		0181	Admixture
0157	Drains trap	0182	Thermostat
0158		0183	Pressure gauge
0159	Level	0184	Roll on board
0160	Calibration	0185	Spark coil-ignition element
0161	Test barrier	0186	Cloth stack
0162	Raising	0187	Lifting of the plaiting table
0163	Raising in direction of cloth	0188	Lowering of the plaiting table
0164	Raising against direction of cloth	0189	Move the plaiting blade
0165	Beating process of fabrics	0190	Reduction of the length of layer
0166	Polishing process of fabrics	0191	Enlargement of the length of layer
0167	Adjustment of pile height	0192	Marking fold protrusion
0168	Rotation of raising cylinder with direction of cloth	0193	Stack height limit
0169	Rotation of raising cylinder against direction of cloth	0194	Rollers
0170	Brushing by means of cross-brush	0195	Disengagement of rollers
0171	Adjustment of cloth rest	0196	Release roller contact pressure
0172	Rope uncurling	0197	Engage lower roller contact
0173	Tighten chain [belt]	0198	Engage upper roller contact
0174	Slacken chain [belt]	0199	Rollers with internal pressure
0175	Temperature control	0200	Rollers with internal pressure-pressing [loading]

18.8 **Symbol No.s** **0201-0250** ISO7-2.MRK

0201	0202	0203	0204	0205	0206	0207	0208	0209	0210
0211	0212	0213	0214	0215	0216	0217	0218	0219	0220
0221	0222	0223	0224	0225	0226	0227	0228	0229	0230
0231	0232	0233	0234	0235	0236	0237	0238	0239	0240
0241	0242	0243	0244	0245	0246	0247	0248	0249	0250

Symbol No.	Referent	Symbol No.	Referent
0201	Ends of rollers	0226	Cloth track entry
0202	Pressure on left-hand ends of rollers	0227	Cloth track exit
0203	Pressure on right-hand ends of rollers	0228	Disturbance
0204	Compensation of dead-weight of upper roller	0229	Conveyer belt
0205	Compensation of dead-weight of left-hand end of upper roller	0230	Emission of heat by radiation
0206	Compensation of dead-weight of right-hand end of upper roller	0231	Pneumatic energy
0207	Lamination	0232	Electric energy
0208	Winding side guide	0233	Pressure measurement
0209	Guide-roller control	0234	Shut-off valve
0210	Guide-roller forwards	0235	Embossing
0211	Guide-roller backwards	0236	Flanged bobbin [beam]
0212	Winding and cutting	0237	Unleaded fuel only
0213	Half-width winding	0238	Parking brake
0214	Cloth scray	0239	Brake failure
0215	Fill the cloth scray	0240	Parking lights
0216	Empty the cloth scray	0241	Opening of front hood [bonnet]
0217	Inspection table	0242	Opening of boot [rear deck]
0218	Raise inspection table	0243	Choke; cold starting aid
0219	Lower inspection table	0244	Horn
0220	Cloth track temperature	0245	Fuel level
0221	Cloth track humidity	0246	Engine coolant temperature
0222	Rinse	0247	Battery charging condition
0223	Cloth track speed compensation	0248	Engine oil
0224	Measure humidity	0249	Engagement of seat belt
0225	Cloth track steaming	0250	Headlamp cleaner

18.9 **Symbol No.s** **0251-0300** ISO7-2.MRK

0251	0252	0253	0254	0255	0256	0257	0258	0259	0260
0261	0262	0263	0264	0265	0266	0267	0268	0269	0270
0271	0272	0273	0274	0275	0276	0277	0278	0279	0280
0281	0282	0283	0284	0285	0286	0287	0288	0289	0290
0291	0292	0293	0294	0295	0296	0297	0298	0299	0300

Symbol No.	Referent	Symbol No.	Referent
0251	Functional arrow	0276	Collet
0252	Interrupted rectilinear motion	0277	Work head; spindle head
0253	Incremental rectilinear motion	0278	Tailstock
0254	Rectilinear repeated positioning	0279	Turret
0255	Single limited rectilinear motion and return	0280	Press slide
0256	Overtravel, rectilinear	0281	
0257	Limited rectilinear motion with delay	0282	Work table -- rectangular
0258	Revolutions	0283	Magnetic plate -- rectangular
0259	Feed	0284	Work table -- round
0260	Longitudinal feed	0285	Magnetic plate -- round
0261	Transverse feed	0286	Rotary tools
0262	Vertical feed	0287	Stationary, single-point tools
0263		0288	Milling cutter
0264	Feed per stroke	0289	Circular saw
0265		0290	Drill
0266	Rapid traverse	0291	Reamer
0267	Spindle	0292	Tap
0268	Spindle, drilling	0293	Cutter block (without blades)
0269	Spindle, milling	0294	Cutter block (with blades)
0270	Spindle, grinding	0295	Grinding [abrasive] wheel
0271	Spindle, tapping	0296	Centreless grinding, abrasive wheel
0272	Quill	0297	Centreless grinding, regulating or feed wheel
0273	Interchange	0298	
0274	Chuck	0299	Abrasive band
0275	Faceplate	0300	Single-point truing [dressing] tool

18.10 **Symbol No.s** **0301-0350** ISO7-2.MRK

0301	0302	0303	0304	0305	0306	0307	0308	0309	0310
0311	0312	0313	0314	0315	0316	0317	0318	0319	0320
0321	0322	0323	0324	0325	0326	0327	0328	0329	0330
0331	0332	0333	0334	0335	0336	0337	0338	0339	0340
0341	0342	0343	0344	0345	0346	0347	0348	0349	0350

Symbol No.	Referent	Symbol No.	Referent
0301	Internal broach	0326	Hand wheel
0302	External broach	0327	Lever
0303	Linear saw	0328	Half-nut
0304	Chain saw	0329	Back stop [gauge] for guillotines
0305	Press tool; die set	0330	Broach puller
0306	Polishing wheel	0331	Broach retriever
0307	Rotary brush	0332	Blow moulding die
0308	Tool-magazine, turret type	0333	Blow needle
0309	Tool-magazine, chain type	0334	Blow mandrel
0310	Tracer template	0335	Compression mould
0311	Chain	0336	Injection mould
0312	Scraping; laying on	0337	Plasticizing unit
0313	Chips; swarf	0338	Plasticizing cylinder
0314	Safety device (mechanical) against overload	0339	Plasticizing cylinder with plunger
0315	Workpiece; product	0340	Plasticizing cylinder with screw
0316	Blow-moulded product	0341	Extrusion die -- general symbol
0317	Compression-moulded product	0342	Multiple strand die (extrusion die)
0318	Injection-moulded product	0343	Sheet die (extrusion die)
0319	Flow-moulded product	0344	Tube die (extrusion die)
0320	Preform for blow moulding	0345	Tubular film die (extrusion die)
0321	Workpiece [product] holder [fixture]	0346	Cable covering die (extrusion die)
0322	Workpiece [product] gripping device	0347	Accumulator with ejector (plastics moulding)
0323	Stretcher bars for plastics moulding	0348	External sizing unit (plastics mouldings)
0324	Sheet stacking	0349	Nip roll assembly with collapsing boards (plastics moulding)
0325	Haul off for plastics moulding	0350	Corrugating device (plastics moulding)

18.11 **Symbol No.s** **0351-0400** ISO7-2.MRK

0351	0352	0353	0354	0355	0356	0357	0358	0359	0360
0361	0362	0363	0364	0365	0366	0367	0368	0369	0370
0371	0372	0373	0374	0375	0376	0377	0378	0379	0380
0381	0382	0383	0384	0385	0386	0387	0388	0389	0390
0391	0392	0393	0394	0395	0396	0397	0398	0399	0400

Symbol No.	Referent	Symbol No.	Referent
0351	Strip feed rollers	0376	Internal cylindrical grinding
0352	Pressure cushion	0377	Plunge cut grinding
0353	Main electrical switch	0378	Face grinding
0354	Plug and socket; plug connection; general	0379	Internal honing
0355	Coolant pump	0380	External honing
0356	Water pump	0381	Lapping
0357	Hydraulic generator	0382	Threading
0358	Hydraulic motor	0383	Reaming
0359	Reservoir	0384	Tapping
0360	Lubricant pump	0385	External broaching
0361	Level indicator (fluid)	0386	Internal broaching
0362	Scraper	0387	Shearing; cutting; guillotining
0363	Pilot flame	0388	Rolling -- symmetrical rolls
0364	Working flame	0389	Rolling -- 4 rolls
0365	Turning	0390	Bending; folding
0366	Boring	0391	Lubricating oil
0367	Planing	0392	Face truing [dressing] by single-point tool
0368	Shaping	0393	Straight truing [dressing] by single-point tool
0369	Slotting	0394	Crush dressing
0370	Drilling	0395	Rotary diamond truing
0371	Milling	0396	
0372	Conventional milling; up cut milling	0397	Load workpiece [product]
0373	Climb milling; down cut milling	0398	Unload workpiece [product]
0374	Grinding	0399	Engage tracer
0375	External cylindrical grinding	0400	Disengage tracer

18.12 Symbol No.s **0401-0450** ISO7-3.MRK

0401	0402	0403	0404	0405	0406	0407	0408	0409	0410
0411	0412	0413	0414	0415	0416	0417	0418	0419	0420
0421	0422	0423	0424	0425	0426	0427	0428	0429	0430
0431	0432	0433	0434	0435	0436	0437	0438	0439	0440
0441	0442	0443	0444	0445	0446	0447	0448	0449	0450

Symbol No.	Referent	Symbol No.	Referent
0401	Rotary tool retension	0426	One cycle
0402	Rotary tool release	0427	Interruption of automatic cycle and return to start position
0403	Close half-nut	0428	Subcycle
0404	Open half-nut	0429	Single tool change arm
0405	Pressure cushion decompressed	0430	Weight
0406	Pressure cushion gripping	0431	Interrupted rotation
0407		0432	Above working temperature range
0408		0433	Below working temperature range
0409		0434	Caution
0410	Folding beam up	0435	Malfunction
0411	Folding beam down	0436	Rotary repeated positioning
0412	Oriented spindle stop	0437	Relative motion out
0413	Material [bar feed] to stop position	0438	Relative motion in
0414	Cores in moulding position	0439	Dimensional arrow
0415	Cores disengaged from moulding position	0440	Direction of continuous rotation; tridimensional presentation
0416	Regulation of wall thickness of preform	0441	Compound slide
0417		0442	
0418		0443	Workpiece separation, sequencing
0419		0444	Workpiece -- stop engage
0420		0445	Workpiece -- stop disengage
0421	Examine; check	0446	Workpiece -- direction selector
0422	Ready (to proceed)	0447	Workpiece -- direction selector (example)
0423	Manual cleaning	0448	Workpiece -- centring
0424	Automatic cleaning	0449	Lock longitudinal, gripping centre points
0425	Double tool change arm	0450	Chuck jaws in changing position

18.13 Symbol No.s **0451-0500** ISO7-3.MRK

0451	0452	0453	0454	0455	0456	0457	0458	0459	0460
0461	0462	0463	0464	0465	0466	0467	0468	0469	0470
0471	0472	0473	0474	0475	0476	0477	0478	0479	0480
0481	0482	0483	0484	0485	0486	0487	0488	0489	0490
0491	0492	0493	0494	0495	0496	0497	0498	0499	0500



















































Symbol No.	Referent	Symbol No.	Referent
0451	Welding torch carrier	0476	Arc ignition by high frequency
0452	Gas supply	0477	Plasmatorch
0453	Workpiece connection	0478	Plasma welding
0454	Dropping voltage characteristic	0479	Plasma cutting
0455	Substantially level voltage characteristic	0480	Plasma gas
0456	Position lamps	0481	Plasma shielding gas
0457	Diesel pre-heat	0482	Plasmatorch connection to electrode (negative supply)
0458	Current slope in	0483	Plasmatorch connection to nozzle (positive supply)
0459	Welding	0484	Punch
0460	Manual metal arc welding	0485	Punching
0461	MIG/MAG welding	0486	Document to be filmed
0462	TIG welding	0487	Document not to be filmed
0463	Manual metal arc welding electrode holder	0488	Original in color
0464	MIG/MAG torch	0489	Microform of first generation in color
0465	TIG torch	0490	Continuation on another reel
0466	Hopper (powder, flux)	0491	Continuation of another reel
0467	Submerged arc welding	0492	Ignition
0468	Arc spot welding	0493	Coordinate tracing
0469	MIG/MAG spot welding	0494	Powder paint marking
0470	TIG spot welding	0495	Bulbous bow
0471	Dip transfer	0496	Side thruster
0472	Spray transfer	0497	"One star" compartment
0473	Pulse transfer	0498	"Two star" compartment
0474	Purging of air (by gas)	0499	"Three star" compartment
0475	Arc ignition by contact	0500	Frozen food storage compartment

18.14 **Symbol No.s** **0501-0550** ISO7-3.MRK

0501	0502	0503	0504	0505	0506	0507	0508	0509	0510
0511	0512	0513	0514	0515	0516	0517	0518	0519	0520
0521	0522	0523	0524	0525	0526	0527	0528	0529	0530
0531	0532	0533	0534	0535	0536	0537	0538	0539	0540
0541	0542	0543	0544	0545	0546	0547	0548	0549	0550

Symbol No.	Referent	Symbol No.	Referent
0501	Adjust cloth [yarn] tension	0526	Kerf
0502	Variation in fabric tension -- with initial position	0527	Reduced run; reduced speed
0503	Symmetrical course	0528	Much reduced run; much reduced speed
0504	Cooling of the fabric web	0529	Smoothing; crushing; rolling
0505	Relative humidity; moisture content	0530	Steam
0506	Do not actuate during operation	0531	
0507	Actuate only during operation	0532	
0508	Count the layers	0533	Upper limit of temperature
0509	Pressing by rollers	0534	Lower limit of temperature
0510	Shut-off valve, straight	0535	Transfer of heat in general
0511	Steam energy	0536	Water
0512	Stretching unit	0537	Air
0513	Spinning nozzle	0538	Cutting, general
0514	Central position	0539	Reversal of sequence
0515	Output convection	0540	Zero-point adjustment
0516		0541	Variability with a preset starting point
0517	Key switch; key fastener	0542	Lifting point; central support
0518	Counting	0543	Air cooling
0519	Punch marking	0544	Water cooling
0520	Punch marking -- single, intermittent, continuous	0545	Chill roll
0521	Movement in direction of arrow from a point of origin	0546	Heating roll
0522	Mechanical energy	0547	Synchronization of speeds (e.g. normal and fast speed)
0523	Heat energy	0548	Pressure control
0524	Water energy	0549	Rotational speed control
0525	Hydraulic energy	0550	Safety cover

18.15 **Symbol No.s** **0551-0600** ISO7-3.MRK

0551	0552	0553	0554	0555	0556	0557	0558	0559	0560
									
0561	0562	0563	0564	0565	0566	0567	0568	0569	0570
									
0571	0572	0573	0574	0575	0576	0577	0578	0579	0580
									
0581	0582	0583	0584	0585	0586	0587	0588	0589	0590
									
0591	0592	0593	0594	0595	0596	0597	0598	0599	0600
									



















































Symbol No.	Referent	Symbol No.	Referent
0551	Pressure rollers	0576	Engage [disengage] with bottom knife shearing roller
0552	Transverse cutting	0577	Adjust shearing roller
0553	Longitudinal cutting	0578	Raising of pile
0554	De-ionization; static discharge	0579	Disengage pile-raising roller
0555	Ionization; static charging	0580	Engage pile-raising roller
0556	Winding with tangential drive	0581	Engage [disengage] pile-raising roller
0557	Winding with direct drive	0582	Processing tank
0558	Winding with tangential and direct drive	0583	Storage tank; preparation tank
0559	Cooling control	0584	Outward flow of heat carrier
0560	Depositing roller	0585	Return flow of heat carrier
0561	Gusset seal off	0586	Preset switching for temperature increase
0562	Gusset seal on	0587	Adjustment of tank to fabric centre
0563	Immersion roller; wash roller	0588	Feeler; sensor
0564	Pressure rollers, one roller with internal pressure	0589	Moisture control
0565	Movement of one unit in two directions	0590	Swivel device for reeling [winding]
0566	Roller; cylinder	0591	Selvedge lifting
0567	Fold retainer	0592	Change of rotational speed
0568	Machines in combined operation	0593	Loop blowing device
0569	Machine in separate operation	0594	Steam blowing device
0570	Brushing against fabric run direction	0595	Circulation compressor
0571	Brushing with fabric run direction	0596	Bleeding
0572	Seam	0597	Adjust arc of contact
0573	Multiple seams	0598	Reduce arc of contact
0574	Adjust shearing unit	0599	Increase arc of contact
0575	Adjust shearing roller to the ledger blade	0600	Adjustment of lower limit of compensator

18.16 Symbol No.s **0601-0650** ISO7-4.MRK

0601	0602	0603	0604	0605	0606	0607	0608	0609	0610
0611	0612	0613	0614	0615	0616	0617	0618	0619	0620
0621	0622	0623	0624	0625	0626	0627	0628	0629	0630
0631	0632	0633	0634	0635	0636	0637	0638	0639	0640
0641	0642	0643	0644	0645	0646	0647	0648	0649	0650

Symbol No.	Referent	Symbol No.	Referent
0601	Adjustment of upper limit of compensator	0626	Keep dry
0602	Loop compartment	0627	Centre of gravity
0603	Single-width fabric	0628	Do not roll
0604	Multi-width fabric	0629	No hand truck here
0605	Wound fabric	0630	Stacking limitation
0606	Heater plate	0631	Clamp here
0607	Fabric out of contact with heater plate	0632	Temperature limitation
0608	Fabric in contact with heater plate	0633	Front fog light
0609	Heating of chamber	0634	Rear fog light
0610	Double plaiting	0635	Windscreen demisting and defrosting
0611	Pattern brushing	0636	Rear window demisting and defrosting
0612	Setting of roughing depth	0637	Interior heating
0613	Knife shaft	0638	Door lock control
0614	Disengage brushing roller	0639	Long-range lamp
0615	Protect from direct sunlight and radioactive materials	0640	Engine
0616	Tilt pointed table	0641	Fuel economy
0617	Adjust right-hand side of pointed table	0642	Air ventilation -- all outlets
0618	Adjust left-hand side of pointed table	0643	Air ventilation -- right outlets
0619	Adjust horizontally pointed table	0644	Air ventilation -- left outlets
0620	Lighter	0645	Air ventilation -- leg room
0621	Fragile; handle with care	0646	Air ventilation -- right and left outlets
0622	Use no hooks	0647	Windshield wiper, intermittent
0623	This way up	0648	Window lift (power operated)
0624	Protect from direct sunlight	0649	Heated seat
0625	Sling here	0650	Subtotal

18.17 **Symbol No.s** **0651-0700** ISO7-4.MRK

0651	0652	0653	0654	0655	0656	0657	0658	0659	0660
									
0661	0662	0663	0664	0665	0666	0667	0668	0669	0670
									
0671	0672	0673	0674	0675	0676	0677	0678	0679	0680
									
0681	0682	0683	0684	0685	0686	0687	0688	0689	0690
									
0691	0692	0693	0694	0695	0696	0697	0698	0699	0700
									

Symbol No.	Referent	Symbol No.	Referent
0651	Horizontal return with linespacing	0676	Toner adjustment
0652	Equals	0677	Lighter copy
0653	Square root	0678	Darker copy
0654	Multiplication	0679	Reduction
0655	Division	0680	Enlargement
0656	Total	0681	Copy quantity selector
0657	Non-add	0682	Format size selector
0658	Linespacing	0683	Copy length selector
0659	Biological risks	0684	Paper [material] thickness -- thick
0660	Master attachment	0685	Paper [material] thickness -- thin
0661	Master alignment; image shift	0686	Primary sheet paper [material] supply
0662	Master inking	0687	Additional sheet paper [material] supply
0663	Master damping	0688	Alternative sheet paper [material] supply
0664	Master priming	0689	Rollpaper [material] supply
0665	Master ejection	0690	Paper platform [feedboard] -- raise
0666	Blanket inking	0691	Paper platform [feedboard] -- lower
0667	Single-sided original	0692	Proof copy; proof set
0668	Double-sided original	0693	Friction pressure
0669	Single-sided copy	0694	Sheet paper [material] feed
0670	Double-sided copy	0695	Counter
0671	Bound original	0696	Key counter
0672	Insert original	0697	Sorter
0673	Remove original	0698	Empty sorter
0674	Semi-automatic original [master] feed (single sheet)	0699	Interleaving
0675	Automatic original [master] feed (from stack)	0700	Remove copies

18.18 **Symbol No.s** **0701-0750** ISO7-4.MRK

0701	0702	0703	0704	0705	0706	0707	0708	0709	0710
0711	0712	0713	0714	0715	0716	0717	0718	0719	0720
0721	0722	0723	0724	0725	0726	0727	0728	0729	0730
0731	0732	0733	0734	0735	0736	0737	0738	0739	0740
0741	0742	0743	0744	0745	0746	0747	0748	0749	0750

Symbol No.	Referent	Symbol No.	Referent
0701	Adjust stop	0726	Horizontal transfer of load: double platform lateral transfer on main platform, left side
0702	Single fold	0727	Horizontal transfer of load: double platform lateral transfer on main platform, right side
0703	Staple	0728	Horizontal transfer of load: double platform lateral readjustment on bridge, left side
0704	Bind	0729	Horizontal transfer of load: double platform lateral readjustment on bridge, right side
0705		0730	Horizontal transfer of load: single platform lateral transfer, left side
0706	Blanket cleaning	0731	Horizontal transfer of load: single platform lateral transfer, right side
0707	Ink roller cleaning	0732	
0708	Detector	0733	
0709	Double original [master] fault	0734	Horizontal transfer of load: main deck loader, longitudinal transfer on aft section of main platform, aft movement
0710	Missed original [master] fault	0735	Horizontal transfer of load: main deck loader, longitudinal transfer on aft section of main platform, forward movement
0711	Double copy fault	0736	Vertical movement: single platform, upwards
0712	Missed copy fault	0737	Vertical movement: single platform, downwards
0713	Paper jam	0738	Stabilizer: combined horizontal and vertical, extension
0714	Paper jam in sorter	0739	Stabilizer: combined horizontal and vertical, retraction
0715	Paper jam in original [master] feed	0740	Vertical movement: double platform bridge, upwards
0716	Call for key operator [assistance]	0741	Vertical movement: double platform bridge, downwards
0717	Call for maintenance	0742	Vertical movement: double platform, main platform, upwards
0718	Add sheet paper [material]	0743	Vertical movement: double platform, main platform, downwards
0719	Add roll paper [material]	0744	Platform pitch adjustment, upwards
0720	Add dry toner	0745	Platform pitch adjustment, downwards
0721	Add ink	0746	Stabilizer: horizontal extension only
0722	Add liquid toner	0747	Stabilizer: horizontal retraction only
0723	Add liquid dispersant	0748	Container stop retraction
0724	Add liquid developer [premix]	0749	Pallet stop retraction
0725	Add water	0750	Stabilizer: vertical extension only

18.19 Symbol No.s **0751-0800** ISO7-4.MRK

0751	0752	0753	0754	0755	0756	0757	0758	0759	0760
0761	0762	0763	0764	0765	0766	0767	0768	0769	0770
0771	0772	0773	0774	0775	0776	0777	0778	0779	0780
0781	0782	0783	0784	0785	0786	0787	0788	0789	0790
0791	0792	0793	0794	0795	0796	0797	0798	0799	0800

Symbol No.	Referent	Symbol No.	Referent
0751	Stabilizer: vertical retraction only	0776	Backward (backward motion): vehicle aft movement
0752	Horizontal transfer of load: main deck loader, longitudinal transfer on bridge, aft movement	0777	Horizontal transfer of load: main deck loader, lateral transfer on aft section of main platform, left side
0753	Horizontal transfer of load: main deck loader, longitudinal transfer on bridge, forward movement	0778	Horizontal transfer of load: main deck loader, lateral transfer of aft section of main platform, right side
0754	Platform telescopic adjustment, extension	0779	Drive unit(s) retraction, up
0755	Platform telescopic adjustment, retraction	0780	Drive unit(s) retraction, down
0756	Aircraft location	0781	Over-travel, rotary
0757	Horizontal transfer of load: main deck loader, four directions transfer on aft section of main platform	0782	Flywheel
0758	Horizontal transfer of load: double platform, longitudinal transfer on main platform, aft	0783	Knob; plunger
0759	Horizontal transfer of load: double platform, longitudinal transfer on main platform, forward	0784	
0760	Horizontal transfer of load: double platform, longitudinal transfer on bridge, aft	0785	
0761	Horizontal transfer of load: double platform, longitudinal transfer on bridge, forward	0786	
0762	Horizontal transfer of load: single platform, longitudinal transfer, aft	0787	Lubricant grease
0763	Horizontal transfer of load: single platform, longitudinal transfer, forward	0788	Static balance
0764		0789	Dynamic balance
0765	Horizontal transfer of load: main deck loader, longitudinal transfer on forward section of main platform, aft movement	0790	
0766	Horizontal transfer of load: main deck loader, longitudinal transfer on forward section of main platform, forward movement	0791	
0767	Horizontal transfer of load: main deck loader, lateral readjustment on bridge, left side	0792	Alignment
0768	Horizontal transfer of load: main deck loader, lateral readjustment on bridge, right side	0793	Print out
0769	Horizontal transfer of load: main deck loader, lateral transfer on forward section of main platform, left side	0794	Input; entrance
0770	Horizontal transfer of load: main deck loader, lateral transfer on forward section of main platform, right side	0795	Output; exit
0771	Horizontal transfer of load: main deck loader, four directions transfer on forward section of main platform	0796	Reciprocating internal combustion engine
0772	Horizontal transfer of load: main deck loader, four directions/readjustment on bridge	0797	Rotary piston engine
0773	Platform roll [twist] adjustment, left side	0798	Rotational speed variation [fluctuation]
0774	Platform roll [twist] adjustment, right side	0799	Speed range
0775	Forward (forward motion): vehicle forward movement	0800	Steady state speed differences

18.20 **Symbol No.s** **0801-0850** ISO7-5.MRK

0801	0802	0803	0804	0805	0806	0807	0808	0809	0810
0811	0812	0813	0814	0815	0816	0817	0818	0819	0820
0821	0822	0823	0824	0825	0826	0827	0828	0829	0830
0831	0832	0833	0834	0835	0836	0837	0838	0839	0840
0841	0842	0843	0844	0845	0846	0847	0848	0849	0850

Symbol No.	Referent	Symbol No.	Referent
0801	Cylinder	0826	Pilot arc
0802	Cylinder leakage	0827	Transferred arc
0803	Cylinder-to-cylinder compression comparison	0828	Non-transferred arc
0804	High voltage short circuit for different cylinders	0829	MIG/MAG spot welding with time control
0805	Primary voltage	0830	TIG spot welding with time control
0806	Ignition voltage	0831	Continuous welding
0807	Calibrated time base	0832	Intermittent welding; tack welding
0808	Ignition voltage displayed in parade	0833	Weld with reduced initial and final current
0809	Ignition voltage displayed in raster	0834	Resistance spot welding, double stroke
0810	Ignition voltage displayed superimposed	0835	Spot welding, single spot welding
0811	TDC position sensor	0836	Spot welding, repeat spot welding
0812	Starter motor	0837	Seam welding with interrupted current
0813	Strobe light	0838	Continuous seam welding; continuous-current seam welding
0814	Ignition timing	0839	Squeeze time
0815	Switching element of the ignition system	0840	Weld current time
0816	Clip-on sensor	0841	Hold time
0817		0842	Off time
0818	Ignition coil	0843	Clamping without welding
0819	Measuring cables	0844	Approach with minimum force
0820	Capacitor	0845	Welding with constant force
0821	Peak voltage	0846	Welding with force variation
0822	Current slope out	0847	Full-wave welding current
0823	Wire feed drive	0848	Half-cycle welding current
0824	Wire feed drive, continuous	0849	Phase shift
0825	Wire feed drive, interrupted	0850	Number of thermal pulses

18.21 **Symbol No.s** **0851-0900** ISO7-5.MRK

0851	0852	0853	0854	0855	0856	0857	0858	0859	0860
0861	0862	0863	0864	0865	0866	0867	0868	0869	0870
0871	0872	0873	0874	0875	0876	0877	0878	0879	0880
0881	0882	0883	0884	0885	0886	0887	0888	0889	0890
0891	0892	0893	0894	0895	0896	0897	0898	0899	0900

Symbol No.	Referent	Symbol No.	Referent
0851	Cool time	0876	Closing of mixing head valve (reacting resin)
0852	Cycle with increasing current up slope	0877	Mixing head for reacting resin
0853	Cycle with decreasing current down slope	0878	Injection mould -- runner closed
0854	Control of "up slope" time	0879	Injection mould -- runner open
0855	Control of "down slope" time	0880	Circulating unit with coolant pump; coolant circulation
0856	Plane of sensitized material	0881	Clamping force, injection moulding
0857	Welding without welding current	0882	Screwing device
0858	Welding with welding current	0883	Calender
0859		0884	Nip roll assembly
0860		0885	Clamping wheel [winder] core
0861		0886	Releasing wheel [winder] core
0862		0887	Preparing for changing reel [winder]
0863	Increased effect [action] in both directions towards a reference point; high pressure	0888	Reel support and winding support -- one-armed
0864	Increased effect [action] towards a reference point; increased force	0889	Reel support and winding support -- two-armed
0865	Nozzle, general	0890	Reel support and winding support -- three-armed
0866	Nozzle closing	0891	Lifting of pile
0867	Nozzle opening	0892	Lowering of pile
0868	Nozzle wiping	0893	Scanning in passage procedure
0869	Nozzle heating	0894	Scanning in reflection procedure
0870	Accumulator	0895	Turning device for continuous material
0871	Filter soiled	0896	Heating of continuous material
0872	Container for reacting resin	0897	Printing unit, impression on
0873	Mixing and measuring unit for reacting resin	0898	Printing unit, impression off
0874	Cut-off sprue (injection moulding)	0899	Adjustment for ink quantity
0875	Inject reacting resin	0900	Doctor blade on

18.22 Symbol No.s **0901-0950** ISO7-5.MRK

0901	0902	0903	0904	0905	0906	0907	0908	0909	0910
0911	0912	0913	0914	0915	0916	0917	0918	0919	0920
0921	0922	0923	0924	0925	0926	0927	0928	0929	0930
0931	0932	0933	0934	0935	0936	0937	0938	0939	0940
0941	0942	0943	0944	0945	0946	0947	0948	0949	0950

Symbol No.	Referent	Symbol No.	Referent
0901	Doctor blade off	0926	Leave contour
0902	Vibrator on feed hopper	0927	Turn right
0903	Drain hood, closable	0928	Straight on or turn right
0904	Drain hood, open	0929	Movements in opposite directions from a common limit
0905	Pelleting machine; preforming press	0930	Movements in opposite directions towards two limits
0906	Dryer, general	0931	Movement to the right with skip of a stop, limited column skip right
0907		0932	Movement to the left with skip of a stop, limited column skip left, vertical tabulation with skip
0908	Operator's mistake	0933	Movement from a limit in arrow direction with skip of a stop
0909	Interference elimination; verification of interference elimination	0934	Movement from a limit in arrow direction with skip of a stop, limited
0910	Setting	0935	Movement with changing direction with skip of a stop, limited; column skip left with linespacing
0911	Value modification in a subdomain	0936	Movement in arrow direction with skip of a stop
0912	Adjustment of a value	0937	Revolution, left
0913	Converter	0938	Limited part of a revolution and return
0914	Safety cover opened	0939	Limited part of one revolution
0915	Safety cover closed	0940	Zero-point motion
0916	Pressure, too low	0941	Direction of continuous rotation, counterclockwise
0917	Pressure, too high	0942	Direction of interrupted rotation, clockwise
0918	Nominal dimensions	0943	Direction of interrupted rotation, counterclockwise
0919	Actual dimensions	0944	Accelerated fast run; accelerated fast speed
0920	Direction of interrupted rectilinear motion	0945	Acceleration
0921	Right-turning movement from a limit	0946	Retardation
0922	Lift-turning movement from a limit	0947	Back-stop for linear motion
0923	Movement in two directions, one limited	0948	Back-stop for rotary motion
0924	Movement with return to the counter direction [U-turn]	0949	
0925	Movement with changing direction limited; horizontal tabulation left with linespacing	0950	

18.23 Symbol No.s **0951-1000** ISO7-5.MRK

0951	0952	0953	0954	0955	0956	0957	0958	0959	0960
0961	0962	0963	0964	0965	0966	0967	0968	0969	0970
0971	0972	0973	0974	0975	0976	0977	0978	0979	0980
0981	0982	0983	0984	0985	0986	0987	0988	0989	0990
0991	0992	0993	0994	0995	0996	0997	0998	0999	1000

Symbol No.	Referent	Symbol No.	Referent
0951	Helical movement	0976	Rotational movement counter-clockwise, with rotation axis parallel to the direction of production
0952	Belgian arrow indicating direction, for public information	0977	Interrupted rotational movement counter-clockwise, with rotation axis parallel to the direction of production
0953	Direction of material; direction of production	0978	Rotational movement clockwise, with rotation axis parallel to the direction of production
0954	Movement in direction of production	0979	Interrupted rotational movement clockwise, with rotation axis parallel to the direction of production
0955	Movement against direction of production	0980	Scale; scale interval
0956	Interrupted movement in direction of production	0981	Data carrier
0957	Interrupted movement against direction of production	0982	Program without machine functions
0958	Flow of material against direction of production (counter stream principle)	0983	Program with machine functions
0959	Flow of material in direction of production (uni-directional stream principle)	0984	Block
0960	Movement upwards, seen in the direction of production	0985	Origin; datum
0961	Movement downwards, seen in the direction of production	0986	Compensation
0962	Interrupted movement upwards, seen in the direction of production	0987	Store
0963	Interrupted movement downwards, seen in the direction of production	0988	Modify; amend; edit
0964	Movement to the left, seen in the direction of production	0989	Forward tape wind, without reading data, without machine functions
0965	Movement to the right, seen in the direction of production	0990	Backward tape wind, without reading data, without machine functions
0966	Interrupted movement to the left, seen in the direction of production	0991	Forward continuous, read all data, without machine functions
0967	Interrupted movement to the right, seen in the direction of production	0992	Forward continuous, read all data, with machine functions
0968	Rotation in the direction of production	0993	Forward block by block, read all data, with machine functions
0969	Rotation against the direction of production	0994	Programmed stop
0970	Interrupted rotation in the direction of production	0995	Programmed optional stop
0971	Interrupted rotation against the direction of production	0996	Forward block by block, read all data, without machine functions
0972	Rotational movement counterclockwise, with rotation axis transverse to the direction of production	0997	Forward, search for particular data, without machine functions
0973	Interrupted rotational movement counter-clockwise, with rotation axis transverse to the direction of production	0998	Backward, search for particular data, without machine functions
0974	Rotational movement clockwise, with rotation axis transverse to the direction of production	0999	Forward, search for block number, without machine functions
0975	Interrupted rotational movement clockwise, with rotation axis transverse to the direction of production	1000	Backward, search for block number, without machine functions

18.24 Symbol No.s **1001-1050** ISO7-6.MRK

1001	1002	1003	1004	1005	1006	1007	1008	1009	1010
1011	1012	1013	1014	1015	1016	1017	1018	1019	1020
1021	1022	1023	1024	1025	1026	1027	1028	1029	1030
1031	1032	1033	1034	1035	1036	1037	1038	1039	1040
1041	1042	1043	1044	1045	1046	1047	1048	1049	1050

Symbol No.	Referent	Symbol No.	Referent
1001	Forward, search for program alignment function, without machine functions	1026	Read data from store
1002	Backward, search for program alignment function, without machine functions	1027	Reset
1003	Beginning of program	1028	Cancel; delete
1004	End of program	1029	Reset store contents
1005	Backward search for beginning of program, without machine functions	1030	Delete store contents
1006	End of program with automatic rewind to beginning of program, without machine functions	1031	Program data error
1007	Optional block skip	1032	Data carrier fault
1008	Manual data input	1033	In position
1009	Axis control, normal (machine follows program)	1034	Storage overflow
1010	Axis control in mirror image mode (machine mirrors program)	1035	Prewarning storage overflow
1011	Reference position	1036	Storage error
1012	Co-ordinate basic origin	1037	Program storage
1013	Absolute program (coordinate dimension words)	1038	Subroutine
1014	Incremental program (incremental dimension words)	1039	Subroutine storage
1015	Zero offset	1040	Program edit
1016	Tool offset (non-rotating tool) -- vertical	1041	Editing data in storage
1017	Tool offset (non-rotating tool) -- horizontal	1042	Buffer storage
1018	Tool length compensation (rotating tool)	1043	Repositioning
1019	Tool radius compensation (rotating tool)	1044	Programmed position
1020	Tool diameter compensation (rotating tool)	1045	Actual position
1021	Tool tip radius compensation	1046	Position error; servo error
1022	Positioning accuracy -- fine	1047	Grid point; sub-reference position
1023	Positioning accuracy -- normal	1048	Program from external device
1024	Positioning accuracy -- coarse	1049	Data carrier input via an alternative device
1025	Write data into store	1050	

18.25 **Symbol No.s** **1051-1100** ISO7-6.MRK

1051	1052	1053	1054	1055	1056	1057	1058	1059	1060
1061	1062	1063	1064	1065	1066	1067	1068	1069	1070
1071	1072	1073	1074	1075	1076	1077	1078	1079	1080
1081	1082	1083	1084	1085	1086	1087	1088	1089	1090
1091	1092	1093	1094	1095	1096	1097	1098	1099	1100

Symbol No.	Referent	Symbol No.	Referent
1051	Do not re-use	1076	Fabric web smoothing
1052	Underwinding	1077	Guide surface of clamp
1053	Bobbin; cops	1078	Link surface of clamping element
1054	Top reserve; tip bunch	1079	Chain link
1055		1080	Cleaning of chain link
1056		1081	Air cushion inlet
1057		1082	Filter-shaking device
1058	Neutral zone	1083	
1059	Adjust limit; adjust sensitivity	1084	Pointed table
1060	Fabric transport in exit zone	1085	Weld one side [end]
1061		1086	Weld both sides [ends]
1062	Circulation pump	1087	Seal longitudinal
1063	Level too high	1088	Dryer of fabric web
1064	Level too low	1089	
1065	Support at centre	1090	Tentering machine
1066	Traveling blower	1091	Hotflue
1067	Interruption in material flow	1092	Cylindrical sliver can
1068	Piecing [joining] material	1093	
1069	Material thickness	1094	Roller (front view)
1070	Creel	1095	Weft [stitch] row
1071	Spinning rotor	1096	Warp
1072	Unwind tape	1097	Selvedge
1073	Selvedge control	1098	Guide track in inlet
1074	Selvedge printer	1099	Roll of fabric (front view)
1075	Added fabric web width adjust smaller	1100	Overfeed

18.26 **Symbol No.s** **1101-1140** ISO7-6.MRK

1101	1102	1103	1104	1105	1106	1107	1108	1109	1110
1111	1112	1113	1114	1115	1116	1117	1118	1119	1120
1121	1122	1123	1124	1125	1126	1127	1128	1129	1130
1131	1132	1133	1134	1135	1136	1137	1138	1139	1140

Symbol No.	Referent	Symbol No.	Referent
1101	Arc of contact	1126	Film movement in direction of arrow
1102	Loop	1127	Take-up magazine
1103	Rotating brush	1128	Feed magazine (for flexible material)
1104	Cross-brush	1129	Recording and play-back
1105	Brush band	1130	Film numbering [identification]
1106	Plaiting	1131	Interrupt
1107	Write and read data into and from store	1132	Uncollated copies; stacks
1108	Remote control, switch on [activate]	1133	Collated copies; sets
1109	Remote control, switch off [deactivate]	1134	Paper clips
1110	Movement to and from the operator	1135	
1111	Movement in two or more steps	1136	Sort in stacks
1112		1137	Photo original
1113		1138	Remove used master container
1114	Movement with normal speed in direction of arrow from a fixed position	1139	Fan fold (continuous stationery)
1115	Movement with fast speed in direction of arrow from a fixed position	1140	Ready
1116	Movement with normal speed in direction of arrow to a fixed position		
1117	Movement with fast speed in direction of arrow to a fixed position		
1118	Ventilator (general)		
1119	Closed (mechanical)		
1120	Opened (mechanical)		
1121	Single exposure technique		
1122	Serial exposure		
1123	Cine radiographic exposure		
1124	Optical focusing of camera		
1125	Camera zoom adjustment		

Template Appendix

A.1 Switch 3D Template Switch Parts OP4-OBJA.CPW

Use the Template parts and tags in combination. This feature allows you to give each part specific functions suitable to a particular use.

SW_3D001 OFF	SW_3D001 ON	SW_3D002 OFF	SW_3D002 ON	SW_3D004 OFF	SW_3D004 ON	SW_3D005 OFF	SW_3D005 ON
SW_3D006 OFF	SW_3D006 ON	SW_3D007 OFF	SW_3D007 ON	SW_3D008 OFF	SW_3D008 ON	SW_3D009 OFF	SW_3D009 ON
SW_3D010 OFF	SW_3D010 ON	SW_3D011 OFF	SW_3D011 ON	SW_3D012 OFF	SW_3D012 ON	SW_3D013 OFF	SW_3D013 ON
SW_3D014 OFF	SW_3D014 ON	SW_3D015 OFF	SW_3D015 ON	SW_3D016 OFF	SW_3D016 ON	SW_3D017 OFF	SW_3D017 ON
SW_3D018 OFF	SW_3D018 ON	SW_3D019 OFF	SW_3D019 ON	SW_3D101 OFF	SW_3D101 ON	SW_3D102 OFF	SW_3D102 ON
SW_3D103 OFF	SW_3D103 ON	SW_3D104 OFF	SW_3D104 ON	SW_3D105 OFF	SW_3D105 ON	SW_3D106 OFF	SW_3D106 ON











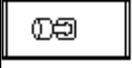
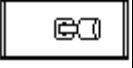













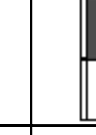







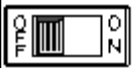
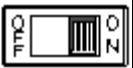
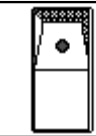

A.1 **Switch** 3D Template Switch Parts OP4-OBJA.CPW

SW_3D107 OFF	SW_3D107 ON	SW_3D108 OFF	SW_3D108 ON	SW_3D109 OFF	SW_3D109 ON	SW_3D110 OFF	SW_3D110 ON
SW_3D111 OFF	SW_3D111 ON	SW_3D112 OFF	SW_3D112 ON	SW_3D113 OFF	SW_3D113 ON	SW_3D114 OFF	SW_3D114 ON
SW_3D115 OFF	SW_3D115 ON	SW_3D116 OFF	SW_3D116 ON	SW_3D117 OFF	SW_3D117 ON	SW_3D118 OFF	SW_3D118 ON
SW_3D119 OFF	SW_3D119 ON	SW_3D120 OFF	SW_3D120 ON	SW_3D121 OFF	SW_3D121 ON	SW_3D122 OFF	SW_3D122 ON
SW_3D123 OFF	SW_3D123 ON	SW_3D124 OFF	SW_3D124 ON				

A.2 **Switch** Plain Template Switch Parts OP4-OBJB.CPW

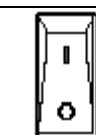
LM_PL001 OFF	LM_PL001 ON	LM_PL002 OFF	LM_PL002 ON	LM_PL003 OFF	LM_PL003 ON	LM_PL005 OFF	LM_PL005 ON
LM_PL006 OFF	LM_PL006 ON	LM_PL007 OFF	LM_PL007 ON	LM_PL008 OFF	LM_PL008 ON	LM_PL009 OFF	LM_PL009 ON
LM_PL010 OFF	LM_PL010 ON	LM_PL011 OFF	LM_PL011 ON	LM_PL012 OFF	LM_PL012 ON	LM_PL013 OFF	LM_PL013 ON
LM_PL014 OFF	LM_PL014 ON	LM_PL015 OFF	LM_PL015 ON	LM_PL016 OFF	LM_PL016 ON	LM_PL017 OFF	LM_PL017 ON
LM_PL018 OFF	LM_PL018 ON	LM_PL019 OFF	LM_PL019 ON	LM_PL020 OFF	LM_PL020 ON	LM_PL101 OFF	LM_PL101 ON
LM_PL102 OFF	LM_PL102 ON	LM_PL103 OFF	LM_PL103 ON	LM_PL104 OFF	LM_PL104 ON	LM_PL105 OFF	LM_PL105 ON

A.2 **Switch** Plain Template Switch Parts OP4-OBJB.CPW

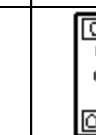
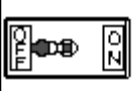
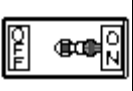
SW_PL106 OFF	SW_PL106 ON	SW_PL107 OFF	SW_PL107 ON	SW_PL108 OFF	SW_PL108 ON	SW_PL109 OFF	SW_PL109 ON
							
SW_PL110 OFF	SW_PL110 ON	SW_PL111 OFF	SW_PL111 ON	SW_PL112 OFF	SW_PL112 ON	SW_PL113 OFF	SW_PL113 ON
							
SW_PL114 OFF	SW_PL114 ON	SW_PL115 OFF	SW_PL115 ON	SW_PL116 OFF	SW_PL116 ON	SW_PL117 OFF	SW_PL117 ON
							
SW_PL118 OFF	SW_PL118 ON	SW_PL119 OFF	SW_PL119 ON	SW_PL120 OFF	SW_PL120 ON	SW_PL121 OFF	SW_PL121 ON
							
SW_PL122 OFF	SW_PL122 ON	SW_PL123 OFF	SW_PL123 ON	SW_PL124 OFF	SW_PL124 ON	SW_PL125 OFF	SW_PL125 ON
							
SW_PL126 OFF	SW_PL126 ON						
							

A.3





























Lamp

3D Template Lamp Parts

OP4-OBJC.CPW

LM_3D001 OFF	LM_3D001 ON	LM_3D002 OFF	LM_3D002 ON	LM_3D003 OFF	LM_3D003 ON	LM_3D005 OFF	LM_3D005 ON
LM_3D006 OFF	LM_3D006 ON	LM_3D007 OFF	LM_3D007 ON	LM_3D008 OFF	LM_3D008 ON	LM_3D009 OFF	LM_3D009 ON
LM_3D010 OFF	LM_3D010 ON	LM_3D011 OFF	LM_3D011 ON	LM_3D012 OFF	LM_3D012 ON	LM_3D013 OFF	LM_3D013 ON
LM_3D014 OFF	LM_3D014 ON	LM_3D015 OFF	LM_3D015 ON	LM_3D016 OFF	LM_3D016 ON	LM_3D017 OFF	LM_3D017 ON
LM_3D018 OFF	LM_3D018 ON	LM_3D019 OFF	LM_3D019 ON	LM_3D020 OFF	LM_3D020 ON	LM_3D021 OFF	LM_3D021 ON
LM_3D101 OFF	LM_3D101 ON	LM_3D102 OFF	LM_3D102 ON	LM_3D103 OFF	LM_3D103 ON	LM_3D104 OFF	LM_3D104 ON

A.3 **Lamp** **3D Template Lamp Parts** OP4-OBJC.CPW

LM_3D105 OFF	LM_3D105 ON	LM_3D106 OFF	LM_3D106 ON	LM_3D107 OFF	LM_3D107 ON	LM_3D108 OFF	LM_3D108 ON
							
LM_3D109 OFF	LM_3D109 ON	LM_3D110 OFF	LM_3D110 ON	LM_3D111 OFF	LM_3D111 ON	LM_3D112 OFF	LM_3D112 ON
							
LM_3D113 OFF	LM_3D113 ON	LM_3D114 OFF	LM_3D114 ON	LM_3D115 OFF	LM_3D115 ON	LM_3D116 OFF	LM_3D116 ON
							
LM_3D117 OFF	LM_3D117 ON	LM_3D118 OFF	LM_3D118 ON				
							

A.4

Lamp

Plain Template Lamp Parts





















OP4-OBJD.CPW

LM_PL001 OFF	LM_PL001 ON	LM_PL002 OFF	LM_PL002 ON	LM_PL003 OFF	LM_PL003 ON	LM_PL005 OFF	LM_PL005 ON
LM_PL006 OFF	LM_PL006 ON	LM_PL007 OFF	LM_PL007 ON	LM_PL008 OFF	LM_PL008 ON	LM_PL009 OFF	LM_PL009 ON
LM_PL010 OFF	LM_PL010 ON	LM_PL011 OFF	LM_PL011 ON	LM_PL012 OFF	LM_PL012 ON	LM_PL013 OFF	LM_PL013 ON
LM_PL014 OFF	LM_PL014 ON	LM_PL015 OFF	LM_PL015 ON	LM_PL016 OFF	LM_PL016 ON	LM_PL017 OFF	LM_PL017 ON
LM_PL018 OFF	LM_PL018 ON	LM_PL019 OFF	LM_PL019 ON	LM_PL020 OFF	LM_PL020 ON	LM_PL101 OFF	LM_PL101 ON
LM_PL102 OFF	LM_PL102 ON	LM_PL103 OFF	LM_PL103 ON	LM_PL104 OFF	LM_PL104 ON	LM_PL105 OFF	LM_PL105 ON

A.4 **Lamp Plain Template Lamp Parts** OP4-OBJD.CPW

LM_PL106 OFF	LM_PL106 ON	LM_PL107 OFF	LM_PL107 ON	LM_PL108 OFF	LM_PL108 ON	LM_PL109 OFF	LM_PL109 ON
LM_PL110 OFF	LM_PL110 ON	LM_PL111 OFF	LM_PL111 ON	LM_PL112 OFF	LM_PL112 ON	LM_PL113 OFF	LM_PL113 ON
LM_PL114 OFF	LM_PL114 ON	LM_PL115 OFF	LM_PL115 ON	LM_PL116 OFF	LM_PL116 ON	LM_PL117 OFF	LM_PL117 ON
LM_PL118 OFF	LM_PL118 ON	LM_PL119 OFF	LM_PL119 ON	LM_PL120 OFF	LM_PL120 ON	LM_PL121 OFF	LM_PL121 ON
LM_PL122 OFF	LM_PL122 ON						

A.5 Display Template Display Parts OP4-OBJE.CPW

XD_3D001	XD_3D002	XD_3D003	XD_3D004	XD_3D005	XD_3D006	XD_3D007	XD_3D008
							
XD_3D009	XD_3D010	XD_PL001	XD_PL002	XD_PL003	XD_PL004	XD_PL005	XD_PL006
							
XD_PL007	XD_PL008	XD_PL009	XD_PL010				
							



A.6 Keypad 3D Template Keypad Parts OP4-OBJF.CPW

<p>KP_3D001D</p>	<p>KP_3D002D</p>	<p>KP_3D002D</p>
<p>KP_3D001H</p>	<p>KP_3D002H</p>	
<p>KP_3D001T</p>		

A.7 Keypad Plain Template Keypad Parts OP4-OBJG.CPW

<p>KP_PL001D</p>	<p>KP_PL002D</p>	<p>KP_PL003D</p>
<p>KP_PL001H</p>	<p>KP_PL002H</p>	
<p>KP_PL001T</p>		

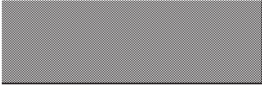
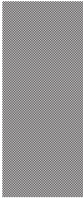
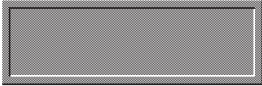
A.8 **Backgrounds** Template Screen Background Parts OP4-OBJH.CPW

Background (horiz.)	Background (vert.)	Background (horiz. 2)	Background (vert. 2)
			
Background (scrn.)	Background (scrn. 2)	Background (scrn. 3)	Background (scrn. 4)
