

PREFACE

Thank you for purchasing the GP Screen Editor Software, "GP-PRO/PB III for Windows Ver. 6.0" for use with Pro-face's GP series programmable operator interfaces.

Please read this manual carefully in order to use this software properly, and be sure to keep this manual handy for future reference.

NOTES

- (1) The copyrights to all programs and manuals included in the GP-PRO/PB III for Windows Ver. 6.0 (hereinafter referred to as "this product") are reserved by the Digital Electronics Corporation. Digital grants the use of this product to its users as described in the "Software Operating License Conditions" documentation, included with this product's CD-ROM. Any actions violating the above-mentioned conditions are prohibited by both Japanese and foreign regulations.
- (2) The contents of this manual have been thoroughly inspected. However, if you should find any errors or omissions in this manual, please inform your local GP representative of your findings.
- (3) Regardless of article (2), the Digital Electronics Corporation shall not be held responsible for any damages or third party claims resulting from the use of this product.
- (4) Differences may occur between the descriptions found in this manual and the actual functioning of this product. Therefore, the latest information on this product is provided in data files (i.e. Readme.txt files, etc.) and in separate documents. Please consult these sources as well as this manual prior to using the product.
- (5) Even though the information contained in and displayed by this product may be related to intangible or intellectual properties of the Digital Electronics Corporation or third parties, the Digital Electronics Corporation shall not warrant or grant the use of said properties to any users and/or other third parties.
- (6) The specifications set out in this manual are for overseas products only. As a result, some differences may exist between the specifications given here and for those of the identical Japanese product. Digital Electronics Corporation accepts no liability for issues related to the intellectual property rights of third parties or any issues related to the use of the information contained in or displayed by this product.

© Copyright 2001 Digital Electronics Corporation. All rights reserved.
Digital Electronics Corporation, November 2001

For the rights to trademarks and trade names, see "TRADEMARK RIGHTS".

TRADEMARK RIGHTS

All company or product names used in this manual are the trade names, trademarks (including registered trademarks), or service marks of their respective companies.

This product omits individual descriptions of each of these rights.

Trademark / Trade Name	Right Holder
Microsoft, MS, MS-DOS, Windows, Windows 95, Windows 98, Windows Me, Windows NT, Windows 2000, Windows XP, Windows Explorer, Microsoft Excel	Microsoft Corporation, USA
Intel, Pentium	Intel Corporation, USA
Pro-face	Digital Electronics Corporation (in Japan and other countries)
Ethernet	Western Digital Electric Corporation, USA
IBM, VGA, IBM Compatible	International Business Machines Corporation (IBM), USA

The following terms differ from the above mentioned formal trade names and trademarks.

Term used in this manual	Formal Trade Name or Trademark
Windows 95	Microsoft® Windows® 95 Operating System
Windows 98	Microsoft® Windows® 98 Operating System
Windows Me	Microsoft® Windows® Me Operating System
Windows NT	Microsoft® Windows® NT Operating System
Windows 2000	Microsoft® Windows® 2000 Operating System
Windows XP	Microsoft® Windows® XP Operating System

LIST OF SUPPORTED MODELS

The GP-PRO/PBIII functions and settings available will vary, depending on the model of GP used. Use the following table to identify your GP.

■ List of GP Series Product

Series	Product Name	Model	GP Type		
GP70 series	GP-H70 series	GP-H70L	GPH70-LG11-24V GPH70-LG41-24VP	GPH70L	
		GP-H70S	GPH70-SC11-24V GPH70-SC41-24VP	GPH70S	
	GP-270 series	GP-270L	GP270-LG11-24V GP270-LG21-24VP GP270-LG31-24V	GP270L	
			GP-270S	GP270-SC11-24V GP270-SC21-24VP GP270-SC31-24V	GP270S
		GP-370 series	GP-370L	GP370-LG11-24V GP370-LG21-24VP GP370-LG31-24V GP370-LG41-24VP	GP370L
	GP-370S			GP370-SC11-24V GP370-SC21-24VP GP370-SC31-24V GP370-SC41-24VP	GP-370S
	GP-470 series		GP-470E	GP470-EG11 GP470-EG21-24VP GP470-EG31-24V	GP470
				GP-570 series	GP-570S
	GP-570T	GP570-TC11 GP570-TC21-24VP GP570-TC31-24V			
		GP-57JS	GP57J-SC11		
	GP-570VM	GP570-TV11	GP570VM		
	GP-571 series	GP-571T	GP571-TC11		GP571T
	GP-675 series	GP-675S	GP675-SC11	GP675	
		GP-675T	GP675-TC11 GP675-TC41-24VP		
	GP-870 series	GP-870VM	GP870-PV11	GP870VM	
	GP77 series	GP-377 series	GP-377L	GP377-LG11-24V GP377-LG41-24V	GP377L
			GP-377S	GP377-SC11-24V GP377-SC41-24V	GP377S
		GP-37W2 series	GP-37W2B	TP37W2-BG41-24V	GP37W2
	GP77R series	GP-377R series	GP-377RT	GP377R-TC11-24V GP377R-TC41-24V	GP377R
				GP-477R series	GP-477RE
GP-577R series		GP-577RS	GP577R-SC11 GP577R-SC41-24VP		
			GP-577RT	GP577R-TC11 GP577R-TC41-24VP	

LIST OF SUPPORTED MODELS

Series		Product Name	Model	GP Type	
GP2000 series	GP2000H series	GP-2301H series	GP-2301HL	GP2301H-LG41-24V	GP2301HL
			GP-2301HS	GP2301H-SC41-24V	GP2301HS
		GP-2401H series	GP-2401HT	GP2401H-TC41-24V	GP2401H
		GP-2300 series	GP-2300L	GP2300-LG41-24V	GP2300L
			GP-2300T	GP2300-TC41-24V	GP2300
		GP-2301 series	GP-2301L	GP2301-LG41-24V	GP2301L
			GP-2301S	GP2301-SC41-24V	GP2301S
		GP-2400 series	GP-2400T	GP2400-TC41-24V	GP2400
		GP-2500 series	GP-2500L	GP2500-LG41-24V	GP2500L
			GP-2500S	GP2500-SC41-24V	GP2500S
			GP-2500T	GP2500-TC11 GP2500-TC41-24V	GP2500
		GP-2501 series	GP-2501S	GP2501-SC11	GP2501S
			GP-2501T	GP2501-TC11	GP2501
		GP-2600 series	GP-2600T	GP2600-TC11	GP2600
				GP2600-TC41-24V	

■ List of GLC Series Product

Series		Product Name	Model	GP Type
GLC100 series	GLC100 series	GLC100L	GLC100-LG41-24V	GLC100L
			GLC100S	GLC100-SC41-24V
GLC300 series	GLC300 series	GLC300T	GLC300-TC41-24V	GLC300T
GLC2000 series	GLC2300 series	GLC2300L	GLC2300-LG41-24V	GLC2300L
			GLS2300T	GLC2300-TC41-24V
	GLC2400 series	GLC2400T	GLC2400-TC41-24V	GLC2400
	GLC2600 series	GLC2600T	GLC2600-TC41-24V	GLC2600

NEW FEATURES

GP-PRO/PBIII for Windows Ver. 6.0 features new functions such as Image Font, Image Parts and Multi Language Display. This section briefly describes each function, listed with the GP Series supporting the respective functions.

<All GP Series>

◆ Registering windows and adding window parts to the Window Screen

The windows registered in the Window Screen (U) can be displayed on the Base Screen (B). The window can be called up with the window parts.

▼ **Reference** ▲ *3.7 Window Display: Window(U) Screen and Base(B) Screen*

◆ Image Conversion: More image files can be converted to the Image Screen.

Additional image files (bitmap files and JPEG files) can be converted into the Image Screen (I file). These image files (called "Image Data") can be registered on the Image Screen as GP screens.

▼ **Reference** ▲ *3.5 Creating an Image: the Image Screen*

◆ Word Log Alarm Message: The numbers of registered messages have been extended.

The number of message lines displayed with the Alarm Summary (Q-tag) has been extended from 256 to 768.

▼ **Reference** ▲ *5.1.1 Alarm Editor ■ Word Alarm Log*

◆ Keypad Input Display: New input styles are available.

Now you can select the input style through Extended feature settings of the Keypad Input Display.

▼ **Reference** ▲ *2.1.14 Keypad Display ■ Keypad Display [Extend] Attributes*

<GP-377/GP77R/GP2000 Series>

◆ Multi Language Display Function

The index text registered with the Text Table Editor allows character strings (Index Text) used for displaying Drawings/Part Labels/Alarms to be switched while the GP is in RUN mode. The language and items displayed on the screen can be changed easily.

▼ **Reference** ▲ *4.6 Table Editor Character Strings*

◆ Pop-up Keypad Function

Touching the Keypad Input Display automatically displays a pop-up keypad for setting numerical values.

▼ **Reference** ▲ *2.1.14 Keypad Display*

<GP77R/GP2000 Series>**◆Monitoring function for touch panel input time**

Touching a specified position on the GP screen for a certain period of time (the time to be monitored can be specified) displays an error message on the screen.

▼Reference▲ *6.1 Menu Setting Items: GP Setup*

<GP2000 Series>**◆Image Parts**

Image Parts can be used for switches and lamps.

Image files (bitmap files and JPEG files) can also be registered as Image Parts.

▼Reference▲ *2.1 Parts ■ Selecting a Part Shape*

◆Image Fonts

Windows fonts are displayed in bitmap format.

▼Reference▲ *2.2.9 Text ◆ Image Font*

◆Screen Capture Function

The screens being displayed on the GP can be saved on a CF Card in JPEG file format (as a hard copy of the GP screens).

▼Reference▲ *Tag Reference Manual, 4.4.9 Screen Capture*

◆Screen Snapshot Function for Simulation Screens

Simulation screens of the GP can be written to a CF Card in JPEG file format as easily as taking a snapshot picture.

▼Reference▲ *8.1.5 Snapshot Function*

◆Extended Video Window Display (v-tag)

The video window set up on the Video Screen (V file) can be displayed on the Base Screen (B). This function is supported only by GP-2500T and GP-2600T series units.

▼Reference▲ *3.6 Video Data Display (V Screen), Tag Reference Manual, 2.28 v-tag (Extended Video Window Display)*

◆Extended LS Area

The user area within the LS area is expanded to LS8191.

<GP2000H Series>**◆Vibration**

Runs the internal motor and vibrates the Handy-type GP(available only for GP2000H series). (Vibration function)

▼Reference▲ *2.9.3 Vibration Function*

■ New PLC Protocol

Toshiba TC200 Series

Keyence KV Series

Matsushita Electric Industrial MINAS-A/S Series

▼Reference▲ *Device/PLC Connection Manual*

HOW TO USE THIS MANUAL

■ Structure of the Manual CD-ROM

The "Operation Manual" is the first of four manuals for this product and explains how to use the "GP-PRO/PB III for Windows Ver. 6.0" software (hereinafter referred to as "this product"). Please refer to all of the manuals named below when using this product. These manuals can be found as PDF files in your "Manual CD-ROM" (CD #2).

In addition to these manuals, data files containing supplemental information on updated functions are also provided. To read these additional data files, click on the [Start] button in your Windows OS main screen and select the [Programs]→[Pro-face]→[ProPB3Win] menu. Then, click on the [Read Me] selection.

For detailed information about GP series products, please refer to each GP's "User Manual". (Optionally available)

Vol. 1	Operation Manual (this manual)	Describes this product's operation procedures and all standard functions. (provided as PDF data)
Vol. 2	Tag Reference Manual	Describes the function of and detailed settings for all GP-PRO/PBIII Tags. (provided as PDF data)
Vol. 3	Parts List	Describes this product's pre-made Parts and symbols. (provided as PDF data)
Vol. 4	Device/PLC Connection Manual	Describes the methods for connecting the GP to other, supported manufacturer PLCs. (provided as PDF data)

* The GP-PRO/PB III Manual describes the procedures for developing GP screens. When developing GLC, simply substitute "GLC" for "GP".

Screen Data Layout Sheets are useful for designing tag address settings, etc. and example sheets are installed as part of the GP-PRO/PBIII for Windows standard installation.

The following two layout sheets, "Device Allocation Table" and "Tag Layout Sheet", are in Microsoft Excel format and are located in the PDF Manual CD-ROM.

The following folder and file names are used.

Folder Name	File Name	Contents
Pro-face\ propbwin\sheet	Device1E.xls	Device Allocation Table
	TAG1E.xls TAG2E.xls TAG3E.xls TAG4E.xls	Tag Layout Sheet

For information on the use of Microsoft Excel, please refer to the Excel software's User Manual.

■ Designation of Supported Models

The functions and settings supported by each model may vary depending on the supported models. In this manual, explanations given are based on the variation of the "Series" and "Product name" described in the "List of Supported Models".

■ Chapter Breakdown

This manual contains 12 chapters and an appendix.
The following is a general description of each chapter:

◆ CHAPTER 1: FUNDAMENTALS OF GP-PRO/PB III FOR WINDOWS

This chapter describes GP-PRO/PBIII usage from start to finish. Also explains the overall structure of the GP-PRO/PBIII Project Manager and Screen Editor areas.

◆ CHAPTER 2: CREATING BASE SCREENS

This chapter describes the basic operations and terminology used for drawing functions, such as “Part”, “Tag”, “Library”, and “D-Script”.

◆ CHAPTER 3: DRAWING APPLICATIONS: CREATING and USING SCREENS

This chapter describes the procedures for creating and using various screens, such as the M, T, K, X, I and V screens, which enable you to create high-quality images and provide advanced-level functionality.

◆ CHAPTER 4: SCREEN AND PROJECT MANAGEMENT

This chapter describes the procedures for editing and saving created screens and project files, and information management procedure.

◆ CHAPTER 5: CREATING AND EDITING ALARMS

This chapter describes the alarm creating and editing procedures.

◆ CHAPTER 6: GP INITIAL AND SYSTEM SETTINGS

This chapter describes the initial setup procedure required to use a GP series display unit.

◆ CHAPTER 7: TRANSFERRING DATA

This chapter describes the procedure for sending created screens to a GP series display unit.

◆ CHAPTER 8: SIMULATION

This chapter describes the procedures for simulating the operation between a GP series panel and a PLC.

◆ CHAPTER 9: PRINTING

This chapter describes the procedure for printing created screens.

◆ CHAPTER 10: ADVANCED FEATURES

This chapter describes the procedures for using GP-PRO/PBIII’s advanced functions such as sound output, filing data (recipe) and logging functions, and CF Card usage. For the detailed information, refer to Volume 3, Tag Reference Manual.

◆ CHAPTER 11: PROJECT MANAGER HIERARCHICAL DISPLAY

This chapter describes the procedures for using the Project Manager in hierarchical display mode.

◆ CHAPTER 12: DATA COMPATIBILITY

This chapter describes the procedure for converting existing screens created with older generation screen editor software (e.g. GP-PRO, GP-PRO II, GP-PRO III, Parts Box) with GP-PRO/PB III for Windows.

◆ **APPENDIX**

• **Error Messages**

Lists the error messages that will be displayed during operation of this product.

• **Troubleshooting**

Provides problem diagnosis and suggests solutions for errors and software operation problems.

• **Address Conversion Tables**

Lists the addresses available for each manufacturer's supported models.

• **Software Trouble Report**

If a software problem persists, even after using the Troubleshooting section, write down information about the problem using this sheet and send it by fax to your local Pro-face support center.

MANUAL SYMBOLS AND TERMINOLOGY





This manual uses the following symbols and terminology.

If you have any questions about the contents of this manual, please contact your local GP distributor.

Also, If you have any question about your personal computer or Windows, please contact your PC distributor or manufacturer.



■ Safety Symbols and Terms

This manual uses the following symbols and terms to identify important information related to the correct and safe operation of this product.

Symbol	Description
	Indicates a potentially hazardous situation that could result in serious injury or death.
	Indicates a potentially hazardous situation that could result in minor injury or equipment damage.
	Indicates a potentially damaging action or dangerous situation that could result in abnormal equipment operation or data loss.
	Indicates instructions or procedures that must be performed to ensure correct product use.
	Indicates instructions or procedures that must not be performed.

■ General Information Symbols and Terms









This manual uses the following symbols and terms for general information.

Symbol	Description
	Provides hints on correct product use, or supplementary information.
	Indicates an item's related information (manual name, chapter, section, sub-section).
	Refers to keys on the computer keyboard. Reference ■ <i>Keyboard Compatibility List</i>
IBM Compatible	Indicates a PC that can run the Windows® operating system.
PLC	PLC (Programmable Logic Controller, sequencer), including thermoregulator, inverter, etc.
GP	Generic name for the "GP Series" of programmable operator interface made by the Digital Electronics Corporation. For a list of compatible GP products please see "Compatible Products and Environmental Specifications". Reference <i>LIST OF SUPPORTED MODELS</i> ■ <i>List of GP Series Product</i>
GLC	Generic name for the GLC Series of Graphic Logic Controllers made by Digital Electronic Corporation. Reference <i>LIST OF SUPPORTED MODELS</i> ■ <i>List of GLC Series Product</i>

■ Keyboard Compatibility List

This manual uses the following symbols to indicate computer keyboard keys.

The key names used by your computer keyboard may differ. Please use the chart below for reference.

Type Symbol	PS/2 Compatible 101 Keyboard
	Esc
	Tab 
	Ctrl
	-Shift
	Alt
	Delete
	Backspace

■ Typical User Configuration

This manual's description of this software's operating procedures and features is based on the PC system configuration shown below.

If you use a different configuration, the PC and GP screens, as well as the names used for pre-made Parts may differ. In this case, please substitute the equivalent screen and part names of your system for those given in this manual.

Hardware/Software	Specification	Remarks
Personal Computer	Windows compatible	
Memory	32MB	
Mouse	Windows compatible mouse	
OS	Windows 98	
Host PLC	Mitsubishi MELSEC AnA series (Link)	
GP	GP-2600T	
Connection between the GP and PC	RS-232C	<u>Recommended Cable:</u> GPW-CB02 Made by Digital Electronics Corporation

PRECAUTIONS

■ CD-ROM Usage Precautions

To prevent CD-ROM damage or malfunctions, please observe the following instructions:



- Do not remove the CD-ROM from the CD-ROM drive while the drive's operation lamp is lit.
- Do not touch the CD-ROM recording surface.
- Do not place CD-ROMs in a place where they may be exposed to extremely high or low temperatures, high humidity, or dust.

■ Product Usage Precautions

To prevent program malfunction or accidents, be sure to observe the following instructions:



- **Touch panel switches should NOT be used for a device's Emergency Stop Switch. Generally speaking, all industrial machinery/systems must be equipped with a mechanical, manually operated emergency stop switch. Also, for other kinds of systems, similar mechanical switches must be provided to ensure safe operation of those systems.**



- Do not turn off your personal computer's power switch during the execution of a program.
- After you create a screen with this product and transfer it to the GP unit, do not send the same screen from the GP to a DOS version of this screen editor software (e.g. GP-PRO/PB III, GP-PRO III).
- Do not change the contents of this product's project files using the Text Editor software.
- Do not send a screen to a GP unit if that GP does not support the functions provided by your screen editor software.

GENERAL GP RESTRICTIONS

There are some restrictions written below in this product.

- The GP-PRO/PB III for Windows software displays screen data using your personal computer's fonts and graphic functions. Therefore, there may be a slight difference between the data displayed on your personal computer and the data displayed on the GP unit after that screen data is sent to the GP.
- When a GP unit is vertically installed, the panel's coordinates will differ from those used on the screen editor software. Therefore, when you enter screen coordinates using tags or D-Script, please consider the GP's orientation.

(0. 0) on the screen editor software

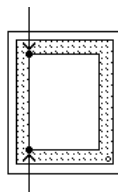

(0. 0) on the GP series' panel

◆ Software and GP Setting Controls

- Certain functions and setting supported by the GP unit are not supported by the GP-PRO/PB III for Windows program, and vice versa.
- Full size characters in screen data drawn in a 2-byte version's drawing environment may not display correctly when displayed in an English (1-byte) drawing environment. If you intend to use the screen data in an English version drawing environment, use only 1-byte alphanumeric characters for all your screen text.

[Setting and functions items set via the GP unit (Not by GP-PRO/PB III for Windows)]

- Language Font selection
- GP Date/Time
- GP Self-Diagnosis Function
- Functions for adjusting the Video Display

[Functions and setting items supported by GP-PRO/PB III for Windows only (Not by the GP unit)]

The following settings are included in the "GP System Settings" area:

- "Checksum Verification"
- "Buzzer Output"
- Screen Change according to standby mode time
- Screen Change Order in hierarchical display mode
- Shift to OFFLINE mode
- "K-tag" processing
- GP unit's internal memory (LS area) backup function
- "Error Display Reset"
- "Watchdog"
- Control word address settings in "CF Card Data Save"
- "Q-tag" settings (Display format, Print Settings, and Alarm Trigger)

- Count Write's Start Address/Processing Performed at GP power-ON/ Perform External Operations/Q-tag: Time Character addition (format)
- Communication Monitoring Period settings (Designate transmission wait time)
- Data address setting for CF Card free space indicator
- Data Backup
- Display Colors
- Serial code reader (LS storage start address/Read complete bit address/Data storage setting)
- The Control Word Address setting for the "Screen Capture" function
- The following GP/PRO/PB III for Windows features, even though they can be set using the GP-PRO/PBIII software, are currently not supported for the following PLCs. **▼Reference▲ Tag Reference Manual**

Be sure to check that your type of PLC supports the features you wish to use on the GP prior to creating your GP-PRO/PBIII for Windows project data.

O : Supported ●: Depending on the type X: Not supported:

<Functions of GP-PRO/PB III for Windows Ver. 5.0>

GP 70 Series

Items	GP-H70 GP-370 GP-57JS	GP-270	GP-470	GP-570	GP-571	GP-675	GP-570VM	GP-870VM	GP-377L	GP-377S	GP-37W2B
Full color (64-color) display	X	X	X	X	O	O	X	X	X	O	X
3-speed blinking	X	X	X	X	O	O	X	X	X	O	X
Data sampling	O	X	O	O	O	O	O	O	O	O	O
LS area backup	X	X	●	●	O	O	X	X	O	O	O
Trend graph (tag) backup	X	X	●	●	O	O	X	X	O	O	O
Trend graph (tag) "block display"	O	X	O	O	O	O	O	O	O	O	O
Trend graph (tag) lower-section fill	O	X	O	O	O	O	O	O	O	O	O
Changing color using K-tag bit	O	X	O	O	O	O	O	O	O	O	O
E-tag, g-tag, K-tag: Indirect color setting	O	X	O	O	O	O	O	O	O	O	O
E-tag, g-tags: Indirect designation of relative value range	O	X	O	O	O	O	O	O	O	O	O
C-tag, E-tag, S-tag: Tiling background colors (Bg)	O	X	O	O	O	O	O	O	O	O	O
g-tag: Color differentiation in graph display	O	X	O	O	O	O	O	O	O	O	O
D-script Additions (Drawing, Math Functions)	O	X	O	O	O	O	O	O	O	O	O
Drawing function (H-tag)	O	X	O	O	O	O	O	O	O	O	O

Items	GP-H70 GP-370 GP-57JS	GP-270	GP-470	GP-570	GP-571	GP-675	GP-570VM	GP-870VM	GP-377L	GP-377S	GP-37W2B
T-tag: Radio switch function	○	×	○	○	○	○	○	○	○	○	○
Inching output switch (Tih-tag and Tiw-tag)	×	×	○	○	○	○	○	○	×	×	×
Q-tag: Backup	×	×	●	●	○	○	×	×	○	○	○
Q-tag: Setting display format	○	×	○	○	○	○	○	○	○	○	○
Q-tag: Display by second	○	×	○	○	○	○	○	○	○	○	○
Q-tag: Setting print color	×	×	×	○	○	○	○	○	×	×	×
Tank graph (pre-made parts)	○	×	○	○	○	○	○	○	○	○	○
Meter graph (pre-made parts)	○	×	○	○	○	○	○	○	○	○	○
Video window display (V-tag)	×	×	×	×	×	×	○	○	×	×	×
Setting Direction of Screen Printout	×	×	×	×	×	○	×	×	×	×	×
Interrupt/cancel hard-copy printout	×	×	○	○	○	○	○	○	×	×	×
Set "OFFLINE" mode switch feature off	○	○	○	○	○	○	○	×	○	○	○
Q-tag: Sub-display	○	×	○	○	○	○	○	○	○	○	○
Q-tag: Grouping of alarms into a block	×	×	×	×	×	×	×	×	○	○	○
A-tag: Indirect designation of text screen or sub-display screen	×	×	×	×	×	×	×	×	○	○	○
Filing data function	×	×	×	×	×	×	×	×	○	○	○
Data logging function	×	×	×	×	×	×	×	×	○	○	○
Sound output function	×	×	×	×	×	×	×	×	×	×	×
CF Card compatibility	×	×	×	×	×	×	×	×	×	×	×
Global D-script	×	×	×	×	×	×	×	×	○	○	○
Compatible with Pro-Server	×	×	×	×	×	×	×	×	×	×	×
Compatible with LS area for simulation	×	×	×	×	×	×	×	×	○	○	○
GP resetting due to write error	×	×	×	×	×	×	×	×	○	○	○
Compatible with transfer speed of 115.2Kbps	×	×	×	×	×	×	×	×	○	○	○
Creation of composite parts for Filing Data	×	×	×	×	×	×	×	×	○	○	○

GENERAL GP RESTRICTIONS

Items	GP-H70 GP-370 GP-57JS	GP-270	GP-470	GP-570	GP-571	GP-675	GP-570VM	GP-870VM	GP-377L	GP-377S	GP-37W2B
D-script: Bit dual state trigger	X	X	X	X	X	X	X	X	O	O	O
D-script: Memory Copy	X	X	X	X	X	X	X	X	O	O	O
D-script: Memory block initialization	X	X	X	X	X	X	X	X	O	O	O
D-script: Loop function	X	X	X	X	X	X	X	X	O	O	O
D-script: Address offset designation	X	X	X	X	X	X	X	X	O	O	O
D-script: Temporary address (can be used up to 90 addresses)	X	X	X	X	X	X	X	X	O	O	O
Filing function: Can be designated up to 10,000 pieces of data	X	X	X	X	X	X	X	X	O	O	O
Filing function: Multiple folders	X	X	X	X	X	X	X	X	O	O	O
Filing function: Stores the cursor position.	X	X	X	X	X	X	X	X	O	O	O
Filing function: PLC data transfer completion Bit Address	X	X	X	X	X	X	X	X	O	O	O
Logging function: Loop function	X	X	X	X	X	X	X	X	O	O	O
Logging function: Total LS data write	X	X	X	X	X	X	X	X	O	O	O
CF Card free capacity storage	X	X	X	X	X	X	X	X	X	X	X
4-state lamp (pre-made parts)	X	X	X	X	X	X	X	X	O	O	O
T-tag: Grouping with auto OFF	X	X	X	X	X	X	X	X	O	O	O
T-tag: Interlock Touch Available Conditions (bit OFF)	X	X	X	X	X	X	X	X	O	O	O
Offline shift (pre-made parts)	X	X	X	X	X	X	X	X	O	O	O
Q-tag block printing	X	X	X	X	X	X	X	X	X	X	X
Q-tag external operation	X	X	X	X	X	X	X	X	O	O	O
A-tag blank line display	X	X	X	X	X	X	X	X	O	O	O
Alarm message: Can be used up to 512 messages	X	X	X	X	X	X	X	X	O	O	O
Backlight burnout detector	X	X	X	X	X	X	X	X	O	O	X
Internal 2-Port function	X	X	X	X	X	X	X	X	O	O	O

Items	GP-H70 GP-370 GP-57JS	GP-270	GP-470	GP-570	GP-571	GP-675	GP-570VM	GP-870VM	GP-377L	GP-377S	GP-37W2B
GB-WEB compatibility	X	X	X	X	X	X	X	X	X	X	X
PLC Simulation via Ethernet	X	X	X	X	X	X	X	X	X	X	X
Factory-Set IP address settings for data transfer	X	X	X	X	X	X	X	X	X	X	X
D-Script I/O function	X	X	X	X	X	X	X	X	X	X	X
Serial 2-D reader compatibility	X	X	X	X	X	X	X	X	X	X	X
Serial bar-code reader compatibility	X	X	X	X	X	X	X	X	X	X	X
256-color display	X	X	X	X	X	X	X	X	X	X	X
Q-tag: up to 2048 messages	X	X	X	X	X	X	X	X	X	X	X
Q-tag: Expansion of time format digits	X	X	X	X	X	X	X	X	0	0	0
T-tag: momentary (one-shot buzzer)	X	X	X	X	X	X	X	X	0	0	0
Number of logging words: 255	X	X	X	X	X	X	X	X	X	X	X

GP77R/GP2000 Series

Items	GP-377R	GP-477R	GP-577R	GP-2301H	GP-2401H	GP-2300	GP-2301	GP-2400	GP-2500	GP-2501	GP-2600
Full color (64-color) display	○	x	○	●	○	●	●	○	○ ^{*7}	○	○
3-speed blinking	○	x	○	●	○	●	●	○	○ ^{*7}	○	○
Data sampling	○	○	○	○	○	○	○	○	○	○	○
LS area backup	○	○	○	○	○	○	○	○	○	○	○
Trend graph (tag) backup	○	○	○	○	○	○	○	○	○	○	○
Trend graph (tag) "block display"	○	○	○	○	○	○	○	○	○	○	○
Trend graph (tag) lower-section fill	○	○	○	○	○	○	○	○	○	○	○
Changing color using K-tag bit	○	○	○	○	○	○	○	○	○	○	○
E-tag, g-tag, K-tag: Indirect color setting	○	○	○	○	○	○	○	○	○	○	○
E-tag, g-tags: Indirect designation of relative value range	○	○	○	○	○	○	○	○	○	○	○
C-tag, E-tag, S-tag: Tiling background colors (Bg)	○	○	○	○	○	○	○	○	○	○	○
g-tag: Color differentiation in graph display	○	○	○	○	○	○	○	○	○	○	○
D-script Additions (Drawing, Math Functions)	○	○	○	○	○	○	○	○	○	○	○
Drawing function (H-tag)	○	○	○	○	○	○	○	○	○	○	○
T-tag: Radio switch function	○	○	○	○	○	○	○	○	○	○	○
Inching output switch (Tih-tag and Tiw-tag)	x	○	○	x	x	x	x	x	x	x	x
Q-tag: Backup	○	○	○	○	○	○	○	○	○	○	○
Q-tag: Setting display format	○	○	○	○	○	○	○	○	○	○	○

Items	GP-377R	GP-477R	GP-577R	GP-2301H	GP-2401H	GP-2300	GP-2301	GP-2400	GP-2500	GP-2501	GP-2600
Q-tag: Display by second	○	○	○	○	○	○	○	○	○	○	○
Q-tag: Setting print color	○	X	○	X	X	●	X	○	○ ^{*7}	○	○
Tank graph (pre-made parts)	○	○	○	○	○	○	○	○	○	○	○
Meter graph (pre-made parts)	○	○	○	○	○	○	○	○	○	○	○
Video window display (V-tag)	X	X	X	X	X	X	X	X	○ ^{*4}	X	○ ^{*4}
Setting Direction of Screen Printout	X	X	X	X	X	X	X	X	X	X	○
Interrupt/cancel hard-copy printout	○ ^{*2}	○	○	X	X	○	X	○	○	○	○
Set "OFFLINE" mode switch feature off	○	○	○	○	○	○	○	○	○	○	○
Q-tag: Sub-display	○	○	○	○	○	○	○	○	○	○	○
Q-tag: Grouping of alarms into a block	○	○	○	○	○	○	○	○	○	○	○
A-tag: Indirect designation of text screen or sub-display screen	○	○	○	○	○	○	○	○	○	○	○
Filing data function	○	○	○	○	○	○	○	○	○	○	○
Data logging function	○	○	○	○	○	○	○	○	○	○	○
Sound output function	X	○ ^{*1}	○ ^{*1}	X	X	X	X	○	○	○ ^{*5}	○
CF Card compatibility	○ ^{*2}	○ ^{*1}	○ ^{*1}	○	○	○	○	○	○	○	○
Global D-script	○	○	○	○	○	○	○	○	○	○	○
Compatible with Pro-Server	○ ^{*2}	○ ^{*3}	○ ^{*3}	X	X	○	X	○	○	○ ^{*3}	○
Compatible with LS area for simulation	○	○	○	○	○	○	○	○	○	○	○
GP resetting due to write error	○	○	○	○	○	○	○	○	○	○	○
Compatible with transfer speed of 115.2Kbps	○	○	○	○	○	○	○	○	○	○	○
Creation of composite parts for Filing Data	○	○	○	○	○	○	○	○	○	○	○

*1 A large-size multi-unit is necessary to enable this function.

*2 A middle-size multi-unit E is necessary to enable this function.

*3 A large-size multi-unit E or GP Ethernet I/F unit is necessary to enable this function.

*4 To utilize this feature, the optional VM unit is required.

*5 A bus conversion unit and a large-scale multi-unit are required to enable this function.

*7 Not available with GP2500L unit.

GENERAL GP RESTRICTIONS

Items	GP - 377R	GP- 477R	GP- 577R	GP- 2301H	GP- 2401H	GP- 2300	GP- 2301	GP- 2400	GP- 2500	GP- 2501	GP- 2600
D-Script: Bit dual state trigger	0	0	0	0	0	0	0	0	0	0	0
D-Script: Memory Copy	0	0	0	0	0	0	0	0	0	0	0
D-Script: Memory block initialization	0	0	0	0	0	0	0	0	0	0	0
D-Script: Loop function	0	0	0	0	0	0	0	0	0	0	0
D-Script: Address offset designation	0	0	0	0	0	0	0	0	0	0	0
D-Script: Temporary address (can be used up to 90 addresses)	0	0	0	0	0	0	0	0	0	0	0
Filing function: Can be designated up to 10,000 pieces of data	0	0	0	0	0	0	0	0	0	0	0
Filing function: Multiple folders	0	0	0	0	0	0	0	0	0	0	0
Filing function: Stores the cursor position.	0	0	0	0	0	0	0	0	0	0	0
Filing function: PLC data transfer completion Bit Address	0	0	0	0	0	0	0	0	0	0	0
Logging function: Loop function	0	0	0	0	0	0	0	0	0	0	0
Logging function: Total LS data write	0	0	0	0	0	0	0	0	0	0	0
CF Card free capacity storage	0 ^{*2}	0 ^{*1}	0 ^{*1}	0	0	0	0	0	0	0	0
4-state lamp (pre-made parts)	0	0	0	0	0	0	0	0	0	0	0
T-tag: Grouping with auto OFF	0	0	0	0	0	0	0	0	0	0	0
T-tag: Interlock Touch Available Conditions (bit OFF)	0	0	0	0	0	0	0	0	0	0	0
Offline shift (pre-made parts)	0	0	0	0	0	0	0	0	0	0	0
Q-tag block printing	0 ^{*2}	0	0	X	X	0	X	0	0	0	0
Q-tag external operation	0	0	0	0	0	0	0	0	0	0	0
A-tag blank line display	0	0	0	0	0	0	0	0	0	0	0
Alarm message: Can be used up to 512 messages	0	0	0	0	0	0	0	0	0	0	0
Backlight burnout detector	0	X	X	0	0	0	0	0	0	0	0
Internal 2-Port function	0	0	0	0	0	0	0	0	0	0	0

*1 A large-size multi-unit is necessary to enable this function.

*2 A middle-size multi-unit E is necessary to enable this function.

Items	GP - 377R	GP- 477R	GP- 577R	GP- 2301H	GP- 2401H	GP- 2300	GP- 2301	GP - 2400	GP- 2500	GP- 2501	GP- 2600
GB-WEB compatibility	○ ^{*2}	○ ^{*3}	○ ^{*3}	X	X	○	X	○	○	○ ^{*6}	○
PLC Simulation via Ethernet	X	X	X	X	X	○	X	○	○	○ ^{*6}	○
Factory-Set IP address settings for data transfer	X	X	X	X	X	○	X	○	○	X	○
D-Script I/O function	X	X	X	X	X	○	X	○	○	X	○
Serial 2-D reader compatibility	X	X	X	X	X	○	X	○	○	X	○
Serial bar-code reader compatibility	X	X	X	X	X	○	X	○	○	X	○
256-color display	X	X	X	X	○	X	X	○	○ ^{*8}	●	○
Q-tag: up to 2048 messages	X	X	X	○	○	○	○	○	○	○	○
Q-tag: Expansion of time format digits	○	○	○	○	○	○	○	○	○	○	○
Japanese FEP	X	X	X	○	○	○	○	○	○	○	○
T-tag: momentary (one-shot buzzer)	○	○	○	○	○	○	○	○	○	○	○
Number of logging words: 255	X	X	X	○	○	○	○	○	○	○	○

*2 A middle-size multi-unit E is necessary to enable this function.

*3 A large-size multi-unit E or GP Ethernet I/F unit is necessary to enable this function.

*6 A bus conversion unit and a large-scale multi-unit E or a GP Ethernet Interface unit are required to enable this function.

*8 Not available with GP2500L and GP2500S units.

<New Functions of GP-PRO/PB III for Windows Ver. 6.0>

GP70 Series

Items	GP-H70 GP-370 GP-57JS	GP-270	GP-470	GP-570	GP-571	GP-675	GP-570VM	GP-870VM	GP-377L	GP-377S	GP37 W2B
Image fonts	x	x	x	x	x	x	x	x	x	x	x
Multi Language Display Function	x	x	x	x	x	x	x	x	○	○	○
Screen Snapshot Function for Simulation	x	x	x	x	x	x	x	x	x	x	x
I/O Setting (Monitor function for touch panel input time)	x	x	x	x	x	x	x	x	x	x	x
Image Parts	x	x	x	x	x	x	x	x	x	x	x
Screen Capture Function	x	x	x	x	x	x	x	x	x	x	x
Compatible with v-tag	x	x	x	x	x	x	x	x	x	x	x
Pop-up Keyboard Function	x	x	x	x	x	x	x	x	○	○	○
Global Vibration Function	x	x	x	x	x	x	x	x	x	x	x

GP77R/GP2000 Series

Items	GP-377R	GP-477R	GP-577R	GP-2301H	GP-2401H	GP-2300	GP-2301	GP-2400T	GP-2500L	GP-2500S	GP-2500T	GP-2501T	GP-2600T
Image Fonts	x	x	x	○	○	○	○	○	○	○	○	○	○
Multi Language Display Function	○	○	○	○	○	○	○	○	○	○	○	○	○
Screen Snapshot Function for Simulation	x	x	x	○	○	○	○	○	○	○	○	○	○
I/O Setting (Monitor function for touch panel input time)	○	○	○	○	○	○	○	○	○	○	○	○	○
Image Parts	x	x	x	○	○	○	○	○	○	○	○	○	○
Screen Capture Function	x	x	x	○	○	○	○	○	○	○	○	○	○
Compatible with v-tag	x	x	x	x	x	x	x	x	x ^{*9}	x ^{*9}	○ ^{*4}	x	○ ^{*4}
Pop-up Keyboard Function	○	○	○	○	○	○	○	○	○	○	○	○	○
Global Vibration Function	x	x	x	○	○	x	x	x	x	x	x	x	x

*4 To utilize this feature, the optional VM unit is required.

*9 Not available with GP2500L and GP2500S units.

GP SERIES COMPATIBILITY

Files created with previous versions of the software can be converted into project files for GP-PRO/PB III for Windows Ver. 6.0.



The following data files cannot be converted.

Source	Destination
GP-PRO/PBIII for Windows Ver.6.0 (This product)	GP-PRO
	GP-PROII
	GP-PROIII
	GP-PRO/PBIII (DOS Version)
	GP-PRO/PBIII (Former Version)
	Parts Box
	LogiTouch Editor

■ Converting Data from GP-PRO/PB III for Windows

A project file from GP-PRO/PB III for Windows can be easily opened with the GP-PRO/PB III for Windows Ver. 6.0 software.

▼ **Reference** ▲ 1.1.2 ■ *Selecting an Existing Project*

■ Converting Data from GP-PRO/PB III (DOS version)

Screen data from GP-PRO/PB III (DOS version) can be opened with the GP-PRO/PB III for Windows Ver. 6.0 software. To do so, specify the "File Type" as a DOS project file (*.PRO) in the [Files of type:] area, when selecting a project.

▼ **Reference** ▲ 1.1.2 ■ *Selecting an Existing Project*

■ Converting Data from GP-PRO, GP-PRO II, or GP-PRO/PB III

GP-PRO II or GP-PRO III Screen data can be converted to 6.0 data for use on GP70/GP77R/GP2000 series units using the GP-PRO/PB III for Windows Ver. 6.0 file converter utility. However, after the GP-PRO II or GP-PRO III SO (System) screen data is converted and sent to a GP70/GP77R/GP2000 series unit, you must then review all GP settings in OFFLINE mode. ▼ **Reference** ▲

12.1 *File Converter*

◆ Cautions when converting GP-PRO II Data

If a GP-PRO II screen contains "filled" data, filled tiling patterns may be shifted when displayed on Power GP series (GP70/GP77R/GP2000 series) units. On GP-*30 and GP-*50 series units, color is filled on the screen based on the drawing's starting point. However, Power GP series (GP70/GP77R/GP2000 series) units fill color from the upper-left corner (0,0) of the screen, and only show the drawing area. Please be aware of this difference when you call up a filled drawing using L-tags, or when placing filled objects on top of one another.

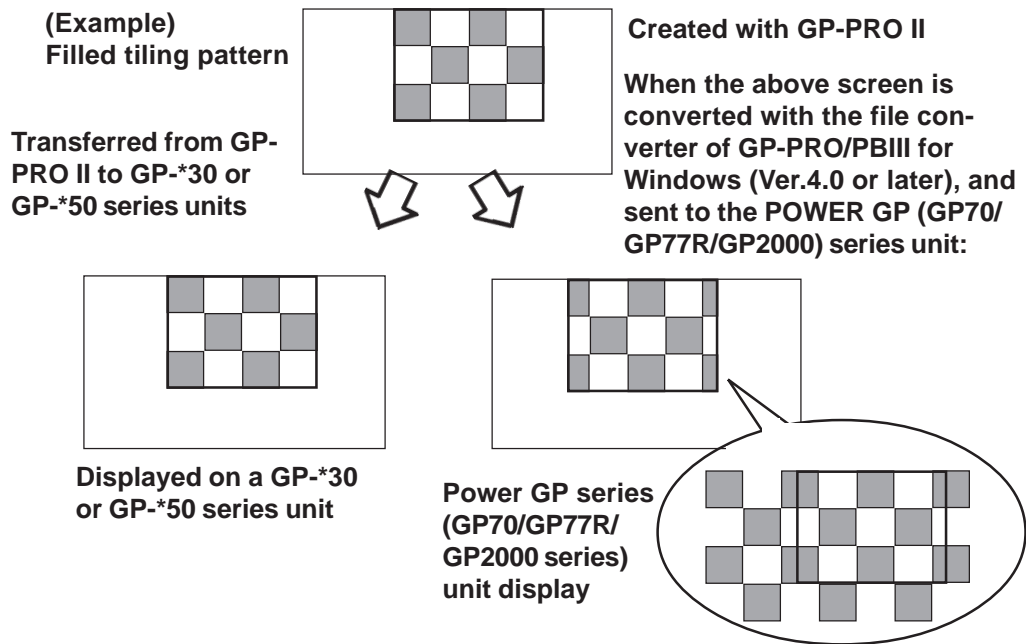

■ Fill-in areas

When painted objects drawn with the GP-PRO, GP-PRO II, GP-PRO III, or GP-PRO/PB III (DOS Version) are converted into data for GP-PRO/PB III for Windows, the object may appear to be incompletely painted. Modify the converted objects as necessary with GP-PRO/PB III for Windows.

■ Converting "Parts Box" Data

The GP-PRO/PB III for Windows Ver. 6.0 file converter can convert Parts Box screen data for use as GP70/GP77R/GP2000 series unit data.

Reference 12.1 File Converter

■ Data Conversion from LogiTouch Editor



Note: This function is available only when GP-PRO/PB III C-Package 01 is installed.

GP-PRO/PB III for Windows Ver. 6.0 can open image data from LogiTouch Editor.

Select the LT Project File (*.LTE) in the "Files of type" field in the "Select" dialog box.

Reference 1.1.2 ■ Selecting an Existing Project

TABLE OF CONTENTS

PREFACE	1
TRADEMARK RIGHTS	2
LIST OF SUPPORTED MODELS	3
NEW FEATURES	5
HOW TO USE THIS MANUAL	7
MANUAL SYMBOLS AND TERMINOLOGY	10
PRECAUTIONS	12
GENERAL GP RESTRICTIONS	13
GP SERIES COMPATIBILITY	23
TABLE OF CONTENTS	25

CHAPTER 1 FUNDAMENTALS OF GP-PRO/PB III for WINDOWS

1.1 From Start to Finish	1-2
1.1.1 Getting Started	1-2
1.1.2 Creating/Selecting/Saving a Project	1-3
1.1.3 Opening/Closing/Saving a Screen	1-9
1.1.4 Quitting GP-PRO/PBIII for Windows	1-14
1.2 Project Manager	1-15
1.2.1 Project Manager Areas and Functions	1-15
1.3 Screen Editor	1-17
1.3.1 Screen Editor Item Names and Functions	1-17
1.3.2 Display Area (50%, 100%, 200%)	1-19
1.3.3 Tool/Icon Display	1-19
1.4 GP-PRO/PB III Manuals and Help	1-20
1.4.1 Browsing Help Topics	1-21
1.4.2 Browsing Home Page	1-23

CHAPTER 2 CREATING BASE SCREENS

2.1 Parts	2-2
2.1.1 Bit Switches	2-22
2.1.2 Word Switches	2-27
2.1.3 Function Switches	2-31
2.1.4 Toggle Switches	2-36
2.1.5 Lamps	2-40
2.1.6 4-State Lamp.....	2-43

TABLE OF CONTENTS

2.1.7	Bar Graphs	2-46
2.1.8	Pie Graphs	2-51
2.1.9	Half Pie Graphs	2-56
2.1.10	Tank Graphs	2-61
2.1.11	Meters	2-66
2.1.12	Trend Graphs	2-71
2.1.13	Keypads	2-77
2.1.14	Keypad Display	2-81
2.1.15	Alarm Display	2-91
2.1.16	File Name Display	2-95
2.1.17	Data Logging Display	2-101
2.1.18	Numeric Displays	2-107
2.1.19	Message Display	2-111
2.1.20	Date Displays	2-117
2.1.21	Time Displays	2-120
2.1.22	Picture Displays	2-122
2.1.23	Window Parts	2-128
2.2	Drawing	2-130
2.2.1	Dot	2-131
2.2.2	Line/Poly-line	2-133
2.2.3	Square/Rectangle	2-135
2.2.4	Circle/Oval	2-137
2.2.5	Arc/Pie	2-139
2.2.6	Fill	2-141
2.2.7	Line / Polygon	2-143
2.2.8	Scale	2-145
2.2.9	Text	2-148
2.2.10	Load Screens	2-154
2.2.11	Load Mark	2-157
2.2.12	Convert (Import) Image	2-158
2.3	Tags	2-160
2.3.1	Designating Tags	2-163
2.4	Object Editing	2-166
2.4.1	Selecting Objects	2-167
2.4.2	Moving Objects	2-173
2.4.3	Scaling Up/Down	2-174
2.4.4	Cut	2-175
2.4.5	Copy	2-176

2.4.6	Paste	2-177
2.4.7	Duplicate	2-178
2.4.8	Delete	2-181
2.4.9	Align	2-182
2.4.10	Rotate Left/ Rotate Right	2-183
2.4.11	Mirror X/ Mirror Y	2-185
2.4.12	Group/Ungroup	2-187
2.4.13	Bring to Front/ Send to Back	2-189
2.4.14	Changing Attributes	2-190
2.4.15	Changing Coordinates	2-192
2.4.16	Editing the Node of a Multi-segment Line	2-193
2.4.17	Transferring a Screen to the Clipboard	2-194
2.4.18	Converting a Screen to a Bitmap File	2-195
2.4.19	Redraw Screen	2-197
2.4.20	Undo	2-198
2.4.21	Redo	2-198
2.5	Libraries.....	2-199
2.5.1	Registering Library Items	2-203
2.5.2	Placing Library Items	2-208
2.5.3	Editing Library Items	2-210
2.5.4	Saving Libraries and Quitting	2-215
2.6	D-Script/Global D-Script	2-217
2.7	Data Sampling.....	2-224
2.8	Efficient Drawing Techniques	2-227
2.8.1	Grid/Snap	2-227
2.8.2	Screen Property Settings	2-230
2.8.3	Preview Screen	2-235
2.8.4	Screen Data List	2-236
2.8.5	Part Reference List	2-238
2.8.6	Tag List	2-241
2.8.7	Cross Reference List	2-243
2.8.8	Load Screen List.....	2-246
2.8.9	Display of Screen Level Change Structure	2-248
2.9	Creating Handy-type GP Screen.....	2-249
2.9.1	Function Keys	2-250
2.9.2	Setting Up the Operation Switch	2-254
2.9.3	Vibration Function	2-256

2.10 DXF Conversion	2-264
2.10.1 Conversion from DXF File to Base Screen (DXF → PRW)	2-264
2.10.2 Conversion from Base Screen to DXF File (PRW → DXF)	2-270

CHAPTER 3 DRAWING APPLICATIONS - CREATING and USING SCREENS

3.1 Creating a Mark: the Mark Screen	3-2
3.1.1 Drawing a Mark	3-4
3.1.2 Special Mark Characters	3-12
3.1.3 Editing a Mark	3-15
3.1.4 Registering and Placing a Mark Library Item	3-25
3.2 Creating a Trend Graph: the Trend Graph Screen	3-26
3.3 Creating a Keypad: the Keypad Screen.....	3-32
3.4 Text Input: the Text Screen	3-37
3.4.1 Editing Text	3-39
3.5 Creating an Image: the Image Screen	3-45
3.5.1 Image Conversion	3-45
3.5.2 Compressing/Decompressing an Image Screen	3-51
3.6 Video Data Display (V Screen)	3-53
3.6.1 Video Settings	3-59
3.6.2 Video Window Settings	3-60
3.7 Window Display: Window (U) Screen and Base (B) Screen.....	3-63
3.7.1 Overview of Window Display	3-63
3.7.2 Window Registration on the U Screen	3-65
3.7.3 Window Registration on the B Screen.....	2-68

CHAPTER 4 SCREEN AND PROJECT MANAGEMENT

4.1 Screen Editing	4-2
4.1.1 Listing/Copying/Deleting Screen	4-2
4.1.2 Copying Screens from Other Projects.....	4-7
4.2 Project Editing	4-11
4.2.1 Deleting Project Files	4-11
4.2.2 Rebuilding A Project (Rebuild)	4-12
4.2.3 Converting Addresses and Device Codes	4-15
4.2.4 Convert Load Screens	4-17
4.2.5 Changing a Project's GP Type	4-19
4.2.6 Changing Your Project's Device/PLC Type	4-21
4.2.7 Changing Extend SIO Type	4-22
4.3 Project Compression/Decompression	4-23

4.3.1	Compressing a Project File	4-24
4.3.2	Decompressing a Project File	4-27
4.4	Comparing Projects.....	4-29
4.5	Information Display	4-31
4.5.1	Project Information	4-31
4.5.2	Screen Information	4-33
4.5.3	Version Information	4-34
4.6	Table Editor Character Strings	4-35
4.6.1	Overview: Multi-language Display Feature	4-35
4.6.2	Table Editor Index Character Strings	4-37
4.6.3	Entering Settings via the Screen Editor	4-43
4.7	Symbol Editor.....	4-46
4.8	Device Monitor.....	4-54

CHAPTER 5 CREATING AND EDITING ALARMS

5.1	Alarm Creation and Editing	5-2
5.1.1	Alarm Editor.....	5-3
5.1.2	Creating an Alarm	5-11
5.1.3	Editing Alarm Data	5-13
5.1.4	Alarm Import/Export.....	5-22

CHAPTER 6 GP INITIAL AND SYSTEM SETTINGS

6.1	Menu Setting Items: GP Setup	6-2
------------	---	------------

CHAPTER 7 TRANSFERRING DATA

7.1	Prior to Transferring Data	7-2
7.1.1	GP Screen Transfer Cable.....	7-2
7.2	Transferring Screens.....	7-3
7.2.1	Transfer Settings	7-4
7.2.2	Passwords	7-8
7.2.3	2-Way Driver	7-10
7.2.4	Transfer Preparation	7-11
7.2.5	When Sending Screens To the GP.....	7-12
7.2.6	When Receiving Data From the GP.....	7-14
7.2.7	Sending/Receiving Dictionary File	7-16
7.2.8	Start GP-Web Compiler	7-17
7.3	Options	7-18
7.3.1	GP Internal Screen Data Information	7-18

7.4 Setting Up Your GP via an Ethernet Network..... 7-21
 7.4.1 Data Transfer Using the Factory-set IP Address 7-25

CHAPTER 8 SIMULATION

8.1 Overview 8-2
 8.1.1 General Description of the Simulation Screen 8-4
 8.1.2 Transferring Simulation Protocol 8-10
 8.1.3 Performing a Simulation 8-11
 8.1.4 Simulation (Ethernet) 8-13
 8.1.5 Snapshot Function 8-16

CHAPTER 9 PRINTING

9.1 Print Settings..... 9-2
 9.1.1 Printing 9-2
 9.1.2 Print Preview 9-7
9.2 Sample Printer Output..... 9-8

CHAPTER 10 ADVANCED FEATURES

10.1 Sound Output..... 10-2
10.2 Filing Data (Recipe) 10-2
10.3 Logging 10-3
10.4 CF Card 10-3
 10.4.1 Using CF Card Tools 10-3
10.5 Creating/Transferring CF Memory Loader Tool..... 10-9
 10.5.1 CF Memory Loader Tool / Backup Data 10-9
 10.5.2 CF Memory Loader Settings 10-11
 10.5.3 Creating System Boot Data for CF Card 10-12
 10.5.4 Sending System Boot Data to CF Card 10-13
 10.5.5 Creating Backup Data 10-13
 10.5.6 Sending Backup Data 10-14
 10.5.7 Receiving Backup Data 10-14
 10.5.8 Transferring "CF Memory Loader Tool" data via CF Card Tool 10-15
10.6 CF Memory Loader Tool 10-16
 10.6.1 About "CF Memory Loader Tool" 10-16
 10.6.2 Starting the "CF Memory Loader Tool" 10-16
 10.6.3 MEMORY LOADER TOOL 10-17
 10.6.4 Menu Screen 10-18

10.6.5 Self Diagnosis 10-25

CHAPTER 11 PROJECT MANAGER HIERARCHICAL DISPLAY

11.1 Project Manager - Hierarchical Display 11-2
11.2 Using Hierarchical Display Mode 11-3

CHAPTER 12 DATA COMPATIBILITY

12.1 File Converter 12-2
 12.1.1 Conversion from GP-PRO II or GP-PRO III 12-2
 12.1.2 Conversion from Parts Box 12-8
 12.1.3 GP-*10 (GPM) File Conversion 12-11
 12.1.4 Reading GP-*10 (GPM) Files 12-16

APPENDICES

A.1 Error Messages Appendix-2
A.2 Troubleshooting Appendix-22
 A.2.1 Troubleshooting List Appendix-22
 A.2.2 Buzzer will not Stop/No Display on the GP/Transfer Disabled Appendix-24
A.3 Address Conversion Tables Appendix-28
A.4 Software Trouble Report Appendix-70

Memo

This chapter describes GP-PRO/PB III for Windows' basic operations such as how to start and quit the software. It also explains the Project Manager and Screen Editor areas, which are used for the majority of screen creation work. Also, a number of tools are introduced here, such as online help, which provide explanations of GP-PRO/PB III for Windows' functions and operations.

1.1 From Start to Finish
1.2 Project Manager
1.3 Screen Editor
1.4 GP-PRO/PB III Manuals and Help

1.1 From Start to Finish



This section describes the GP-PRO/PB III for Windows program's operation flow from start to finish.

Usage Pattern			
Start	→ Create/Select a project file with the Project Manager.	→ Create/Edit a screen with the Screen Editor.	→ Save the screen, and quit the Screen Editor. → Save the project, and quit the Project Manager.

1.1.1 Getting Started

■ Starting GP-PRO/PB III for Windows

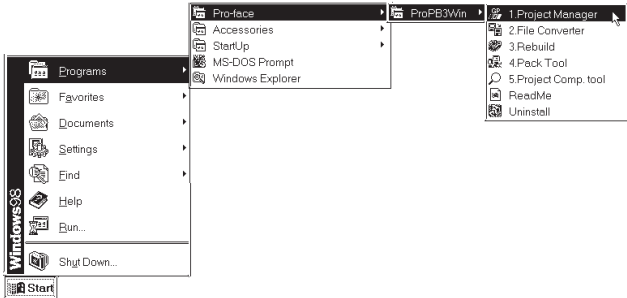
The following explanation assumes your PC is turned on and the Windows desktop has appeared.

PROCEDURE	REMARKS
<p>(1) Click on the [Start] button, and point to the [Programs] - [Pro-face] - [ProPB3Win] menu. Then, click on the [1. Project Manager] command.</p> 	<p>If you double-click directly on a previously made project file (*.PRW file) via the Explorer software, GP-PRO/PB III for Windows will automatically start.</p>
<p>(2) The Project Manager screen appears.</p> 	

1.1.2 Creating/Selecting/Saving a Project

A project file (PRW file) normally contains multiple screens intended for the operation of a certain system. GP-PRO/PB III for Windows creates one project file for the operation of one system, enabling system management by project file units.

You can send the screen data of one project file or individual screens of the same project file to the GP unit. Screens of different project files cannot be used simultaneously on the GP unit.

■ Creating a New Project

When you create a new project, you must designate the GP, Device/PLC and Extend SIO Type information, according to your current application.

◆ GP Type

Select your Device/PLC Type according to the series of the Device/PLC Type **▼Reference▲** *LIST OF SUPPORTED MODELS*

◆ Device/PLC Type

Select the type of Device/PLC to be connected to your GP unit.

▼Reference▲ *Device/PLC Connection Manual*

◆ Extend SIO Settings

Select the type of Extend SIO.

This feature can be selected only when the GP-2000 series (except the GP-2301 and GP-2501) is selected as the GP Type.

• Serial Code Reader (LS)

Select this option when connecting a Two-Dimensional Code Reader to the extended serial interface.

▼Reference▲ *Tag Reference Manual, 4.5.2 Compatible 2-D Code readers*

• General SIO Protocol

Select this option when using extended SIO functions with D-script.

▼Reference▲ *Tag Reference Manual, 3.1.11 D-Script Extended SIO Function*

• Serial Code Reader (K-tag)

Select this option when connecting a One-Dimensional Code Reader to the extended serial interface.

▼Reference▲ *Tag Reference Manual, 4.6 Bar Code Reader Compatibility*

PROCEDURE	REMARKS
-----------	---------

(1) Select the Project Manger's [Project] menu - [New] command, or click on  .



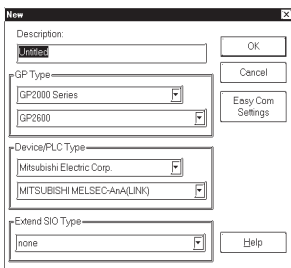

(2) Enter a description and select the GP Type and PLC Type from the pull-down menu. Make the settings for Extended SIO Settings as necessary.

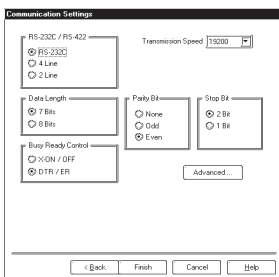

Click the [OK] button in step (2) to skip step (3) and jump to step (4).

(3) Click the [Easy Com Settings] button to enable [Mode Settings], [System Area Settings] and [Communication Settings] for the PLC Type selected in step (2). When all settings are completed, press the [Finish] button.



(4) The GP-PRO/PBIII for Windows system will then ask you if you wish to create a screen. If you click on the  button, the Screen Editor will start and you can begin laying out your screen.

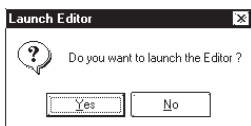

When entering a description, you can use up to 60 single-byte characters.

Reference *“Device/PLC Connection Manual”.*

The settings on the left can also be made by clicking  in the Project Manager.

Reference *1.1.3 Opening/Closing/Saving a Screen*



Note: If you attempt to create another project file without saving a newly created project file, the system asks if you wish to save the current file. If you click on the button, the [Save As] dialog box appears. If you click on the button, the system opens a new screen without saving the current project file.

Reference 1.1.2 ■ Saving a Project File under a Different Name

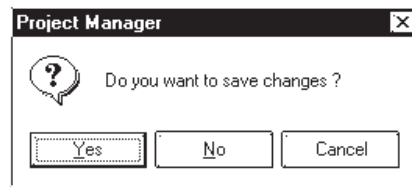

■ Selecting an Existing Project

Select the Project Manger's [Project] menu - [Select] command, or click on



. When you select a project, the following setting screen appears:

◆ File Types

You can select either a project file created with the DOS version of GP-PRO/PB III (DOS project file: *.PRO), or a project file created with GP-PRO/PB III for Windows (project file: *.PRW).





Important

If you specify the GP type as "GP570VM" in a DOS project file, and the GP type is not recognized as "GP570VM" in GP-PRO/PB III for Windows, then re-register the GP type as "GP570VM" in the Windows version.

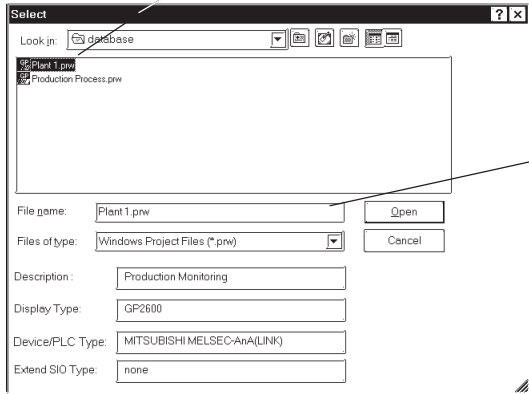
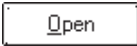

Note:

Double-clicking on the file (project file: *.PRW) itself in Explorer automatically starts GP-PRO/PB III for Windows and opens the file.

PROCEDURE	REMARKS
<p>(1) Select the Project Manger [Project] menu's [Select] command, or click on  .</p> <p>(2) Select a project file from the list that appears, or type the project file name. Select "Factory A"</p>  <p>To type a file name via the keyboard, type the file name here.</p> <p>(3) Click on the  button to open the selected file.</p>	<p>To select a project file located in another folder, find a desired file from the "Look in: (File location)".</p> <p>To select a file created with the DOS version of GP-PRO/PB III, select "DOS Project File (*.pro)" in "File Type:".</p> <p>When you double-click on the file name selected in step (2), you can skip the  command.</p> <p>Reference To create a screen, refer to <i>1.1.3 Opening/Closing/Saving a Screen.</i></p>

■ Saving a Project



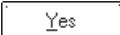

When the data of an existing project file is changed, the changes will be automatically saved.

However, if you attempt to create a another new project file without first saving your current project file, the GP-PRO/PBIII will ask if you wish to save the current file. If you click on the  button, the [Save As] dialog box will appear.

Reference 1.1.2 ■ *Saving a Project File under a Different Name*

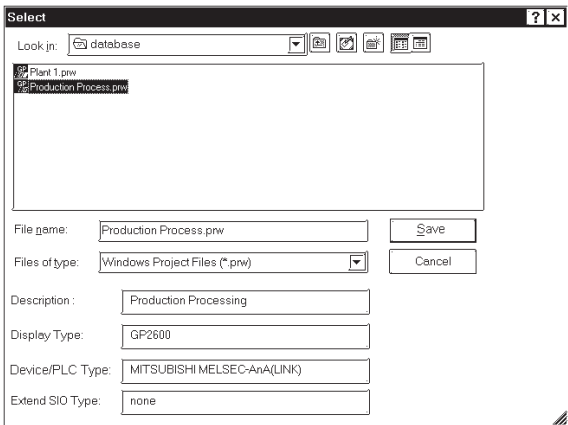
■ **Saving a Project File under a Different Name**

You can save an existing project file under a different name or with different GP type, Device/PLC type and Extend SIO settings.

PROCEDURE	REMARKS
<p>(1) Select the [Project] menu - [Save As] command in the Project Manager.</p> <p>(2) The comment, GP type, Device/PLC type and Extend SIO of the currently opened project file are displayed.</p> <p>Enter the desired file name, and enter the items to be changed.</p> 	<p>The file name can contain up to 255 characters (including the path-name and extension.)</p> <p> Important Before changing the GP type, check the preset data, since the drawing area and functions vary depending on the type of the GP unit.</p> <p>Reference 4.2.5 Changing a Project's GP Type</p> <p> Important Once the Device/PLC type is changed, you must change the addresses of the Parts, Tags, D-Scripts and alarms, and perform the GP system setup again.</p> <p>Reference 4.2.6 Changing Your Project's Device/PLC type</p> <p>Reference To open another project file, see "1.1.2 ■Creating a New Project or ■Selecting an Existing Project".</p> <p>Reference To close GP-PRO/PBIII for Windows, see "1.1.4 Quitting GP-PRO/PBIII for Windows".</p>
<p>(3) Click on the <input type="button" value="Save"/> button to save the file.</p> <p>If a project file with the same name exists, GP-PRO/PBIII will ask if you want to replace (overwrite) the existing project file with the project file you are attempting to save.</p> <p>If so, click on the <input type="button" value="Yes"/> button. If you do not wish to overwrite the existing project file, click on the <input type="button" value="No"/> button.</p> 	



- **When a Vertical GP unit is replaced with the horizontal type, or vice-versa, the displayed screen will rotate 90° relative to the original data. In this case, you must edit the displayed data using the [Rotate] command. After editing, be sure to check the displayed data.**

Example)



Horizontal type





Vertical type

- **When a high-resolution type GP unit is replaced with a low-resolution type, high-resolution data can not longer be displayed. If the low-resolution type GP unit is again replaced with a high-resolution type and the same project file is used, the data will once again be displayed.**
- **The maximum number of characters used for an alarm summary in the low-resolution type is different from that of the high-resolution type. When an alarm message created with the high-resolution type is used in a low-resolution type, data extending beyond the message area will not be displayed.**

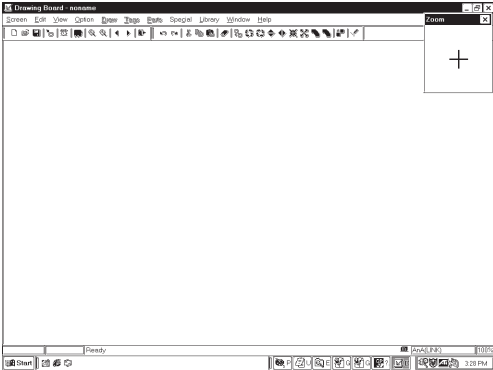

1.1.3 Opening/Closing/Saving a Screen

After selecting a project file, you can create a screen. First, you must move from the Project Manager to the Screen Editor, and open a screen. This section describes the procedures for opening, closing, and saving a screen.

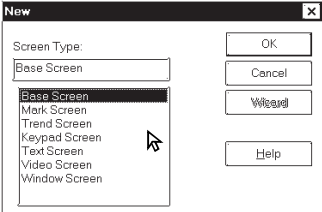
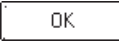
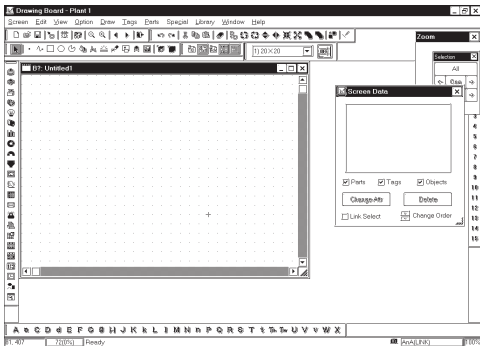
Opening a New Screen

PROCEDURE	REMARKS
<p>(1) Select the Project Manger's [Screen/Setup] menu - [Editor] command, or click on  . The Screen Editor's opening screen will appear.</p> 	<p>When the Screen Editor has already been started, skip step (1).</p>
<p>(2) Select the Screen Editor [Screen] menu's - [New] command, or click on  .</p>	<p>Selecting the [Screen] menu's - [Open] command or clicking on  and entering an unregistered screen number can also be used to open a new screen.</p>
<p>(3) Select the screen type.</p> 	<p>Enter the screen number and title when saving the screen.</p> <p>Reference 1.1.3 ■ Saving a Screen under a Different Name</p>
<p>(4) Click on the  button to create the desired type of screen. The designated GP type's drawing screen will appear.</p> 	<p>Up to twenty screens can be simultaneously opened.</p> <p>Multiple types of windows can be opened on any one screen at the same time.</p>

■ Opening a Previously Saved Screen

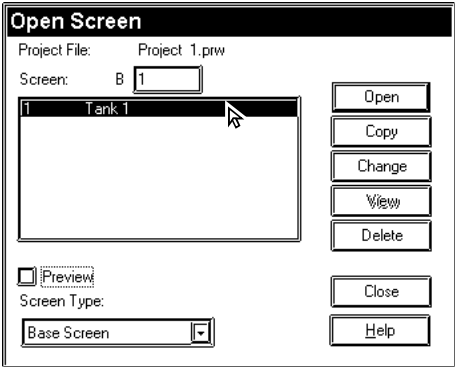
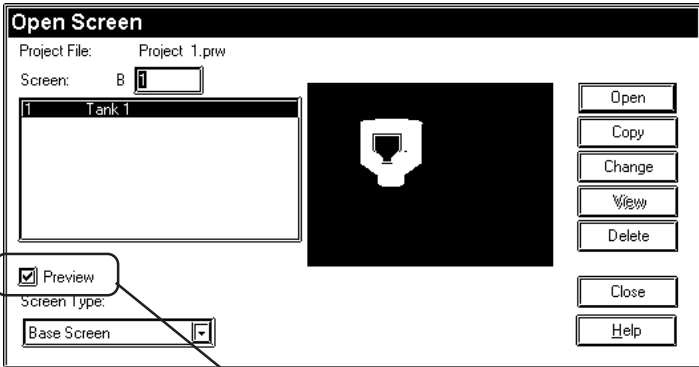
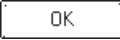
PROCEDURE	REMARKS
<p>(1) Select the [Screen/Setup] menu's - [Editor] command, or click on  in the Project Manager.</p> <p>The Screen Editor's opening screen will appear.</p> <p>(2) Select the [Screen] menu's - [Open] command or click on .</p> <p>(3) Use this screen to select a screen name from the list, or select the screen type and enter the screen number.</p> <p>When checking the [Preview] check box, the selected screen image can be viewed in the dialog box.</p>  <p style="text-align: center;">↓</p> <p style="text-align: center;">Place a check mark in the [Preview] box.</p>  <p style="text-align: center;">Preview Check Box</p>	<p>When the Screen Editor has already been started, skip step (1).</p> <p>When you double-click on the desired screen number in step (3), you can skip the operation of the  button.</p> <p>If you enter a screen number that has not been registered in the list, a new screen will be opened and that number will be assigned to it.</p> <p>When selecting multiple screens, a screen with the smallest screen number of them will be displayed.</p>

PROCEDURE	REMARKS
-----------	---------

(4) Click on the OK button to open the screen.

The selected screen will be opened.

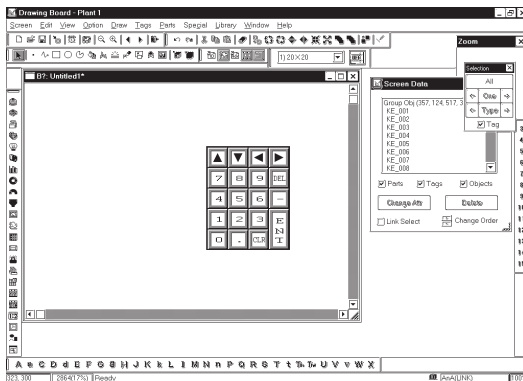

Up to twenty screens can be open at the same time.

To select several screens simultaneously, while pressing the Shift key, click on a screen and drag the mouse over desired adjacent screens; or, you can select screens individually by clicking on them while pressing the Ctrl key.

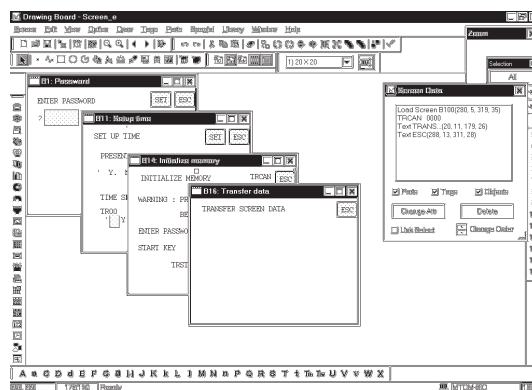
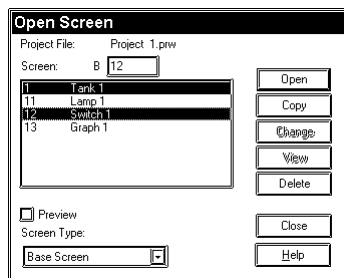

■ Saving a Screen

PROCEDURE	REMARKS
<p>(1) Select the [Screen] menu- [Save] command, or click on  in the Screen Editor</p> <p>(2) The current screen will be saved overwriting the previous one.</p>	<p>After the screen is saved, it will remain open.</p> <p>▼ Reference ▼ To open another screen, see <i>1.1.3 ■ Opening a New Screen</i>.</p> <p>▼ Reference ▼ To quit GP-PRO/PBIII for Windows, see <i>1.1.4 Quitting GP-PRO/PBIII for Windows</i>.</p> <p>When you attempt to save a new screen, the [Save As] dialog box will appear.</p> <p>▼ Reference ▼ <i>1.1.3 ■ Saving a Screen under a Different Name</i></p>

■ Saving a Screen under a Different Name

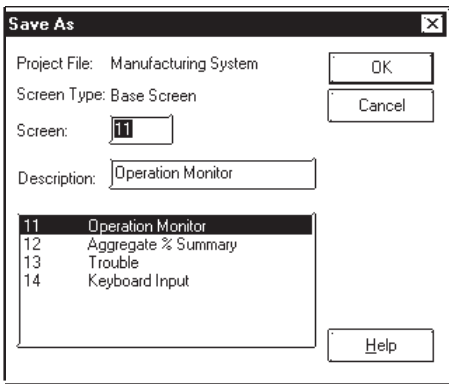
PROCEDURE	REMARKS
<p>(1) Select the [Screen] menu - [Save As] command in the Screen Editor.</p> <p>(2) The type, number, and title of the current screen is displayed.</p> <p>You can change the setting of a desired item; however, the screen's type cannot be changed.</p> 	<p>A “,” (comma) cannot be used in a description.</p> <p>After the screen is saved, it will remain open.</p> <p>If the screen is saved as a different screen number, the screen of the updated number will be displayed.</p> <p>▼ Reference ▼ To open another screen, see <i>1.1.3 ■ Opening a New Screen</i> or <i>■ Opening a Previously Saved Screen</i>.</p> <p>▼ Reference ▼ To quit GP-PRO/PBIII for Windows, see <i>1.1.4 Quitting GP-PRO/PBIII for Windows</i>.</p>

PROCEDURE	REMARKS
<p>(3) Click on the <input type="button" value="OK"/> button to register the above settings.</p> <p>If a screen with the same number exists, the system asks if you want to replace the existing screen with the screen you are attempting to save.</p> <p>If so, click on the <input type="button" value="OK"/> button. If you do not wish to overwrite the existing screen, click on the <input type="button" value="Cancel"/> button.</p> 	

■ Closing a Screen

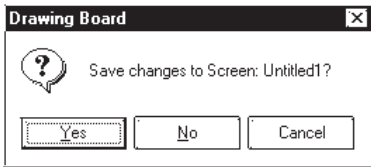
PROCEDURE	REMARKS
<p>(1) Select the [Screen] menu - [Close] command in the Screen Editor.</p> <p>(2) The screen will close.</p> <p>If you attempt to close an updated screen without saving it, the system asks if you wish to save the current screen.</p> <p>If you click on the <input type="button" value="Yes"/> button, the system saves the updated data. If you click on the <input type="button" value="No"/> button, the system closes the screen without saving the updated data.</p> 	<p>You can also close the screen by clicking on the <input checked="" type="checkbox"/> button at the upper right corner of the window (drawing area).</p> <p>When you attempt to save a new screen, the [Save As] dialog box appears.</p> <p>▼ Reference ▲ 1.1.3 ■ Saving a Screen under a Different Name</p> <p>▼ Reference ▲ To open another screen, see 1.1.3 ■ Opening a New Screen or ■ Opening a Previously saved Screen.</p> <p>▼ Reference ▲ To quit GP-PRO/PBIII for Windows, see 1.1.4 Quitting GP-PRO/PBIII for Windows.</p>

1.1.4 Quitting GP-PRO/PBIII for Windows

■ Quitting the Screen Editor

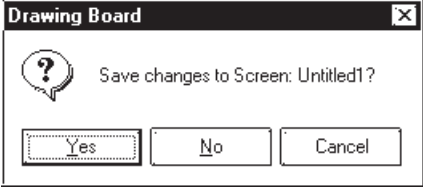
PROCEDURE	REMARKS
<p>(1) Select the [Screen] menu - [Exit] command, or click on  in the Screen Editor.</p> <p>(2) The Screen Editor will close.</p> <p>If you attempt to close the Screen Editor without first saving the currently edited screen, GP-PRO/PBIII asks if you wish to save the updated screen. If you click on the <input type="button" value="Yes"/> button, GP-PRO/PBIII saves the updated data. If you click on the <input type="button" value="No"/> button, GP-PRO/PBIII quits the Screen Editor without saving the updated data.</p> 	<p>When you save a new screen, the [Save As] dialog box appears.</p> <p>▼ Reference ▲ 1.1.3 ■ Saving a Screen under a Different Name</p>

■ Quitting GP-PRO/PBIII for Windows

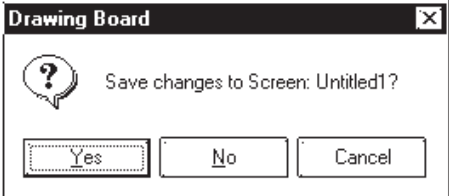
PROCEDURE	REMARKS
<p>(1) Select the [Project] menu - [Exit] command, or click on  in the Project Manager.</p> <p>(2) The Project Manger will quit.</p> <p>If you attempt to close the Project Manager without saving the currently opened screen’s updated data, GP-PRO/PBIII asks if you wish to save your project’s data. If you click on the <input type="button" value="Yes"/> button, GP-PRO/PBIII saves the updated data. If you click on the <input type="button" value="No"/> button, GP-PRO/PBIII quits (closes) without saving the updated data.</p> 	<p>Once you have opened the Screen Editor, you must either quit it, or go to the Project Manager.</p> <p>▼ Reference ▲ 1.1.4 ■ Quitting the Screen Editor</p>

1.2 Project Manager

All GP-PRO/PB III for Windows system level settings and functions are controlled via the Project Manager.

1.2.1 Project Manager Areas and Functions

Here, each of the Project Manager's features is explained. To begin working with GP-PRO/PBIII for Windows, simply click on the desired button.

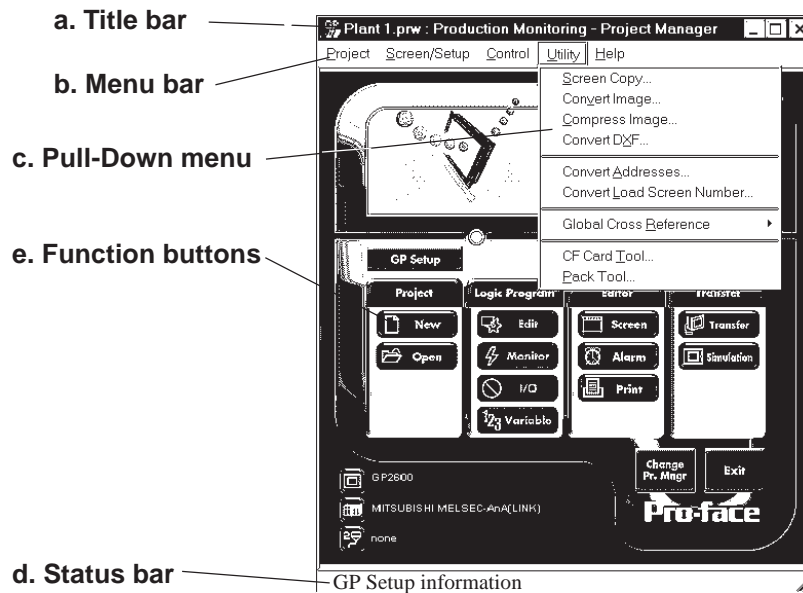

a. Title Bar:

Displays the current project's file name and title.

b. Menu Bar:

Displays the menus used for the operation of GP-PRO/PBIII for Windows. When you select a desired menu using the mouse or keyboard, one of the pull-down menus described below will appear.

c. Pull-Down Menu:

When you select a desired item on the menu bar, its pull-down menu appears. These menus include a variety of commands.

d. Status Bar:

Displays GP and Device/PLC Types as well as GP-PRO/PBIII operation related messages.

e. Function Buttons

These buttons indicate the GP-PRO/PB III for Windows program's main functions (e.g. Creating Screens/alarm, Printing). You can start each function by simply clicking on that function's button. You can also start these functions by selecting the corresponding command from the Project Manager's pull-down menu.

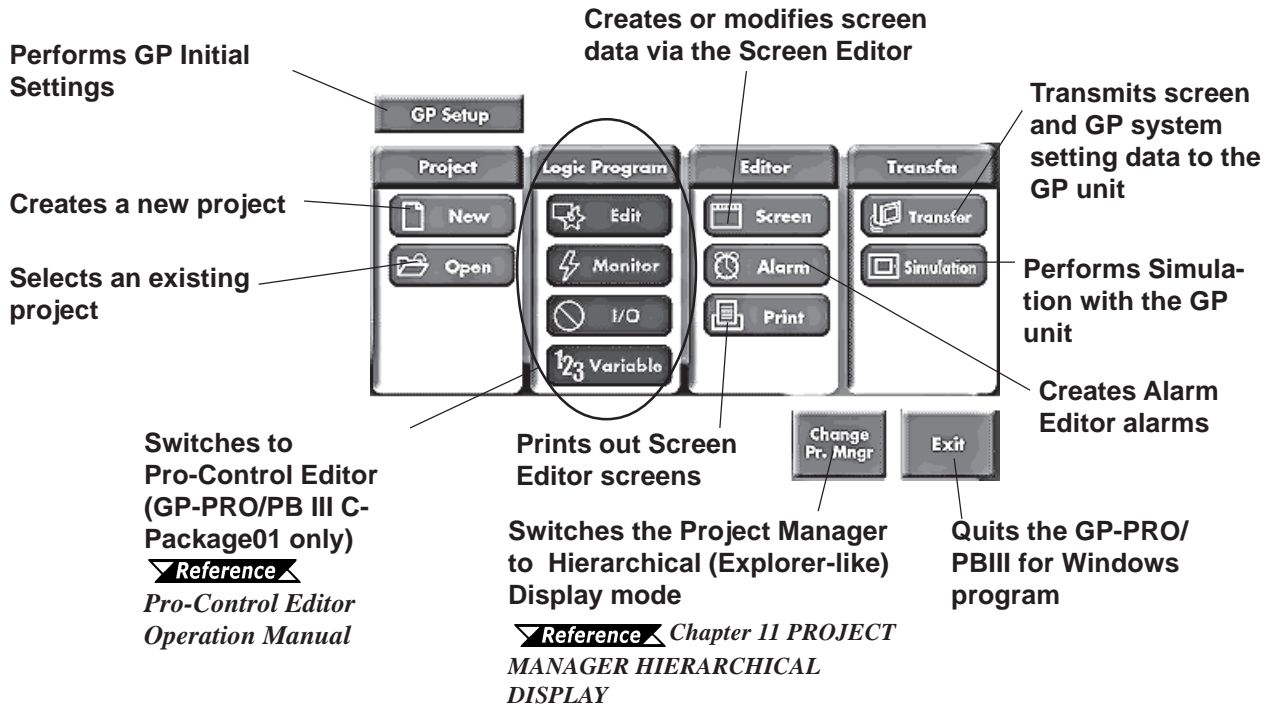

1.3 Screen Editor

GP operation and display screens are created in the Screen Editor.

1.3.1 Screen Editor Item Names and Functions

The names and functions of the GP-PRO/PBIII for Windows editor’s screen items are as follows:

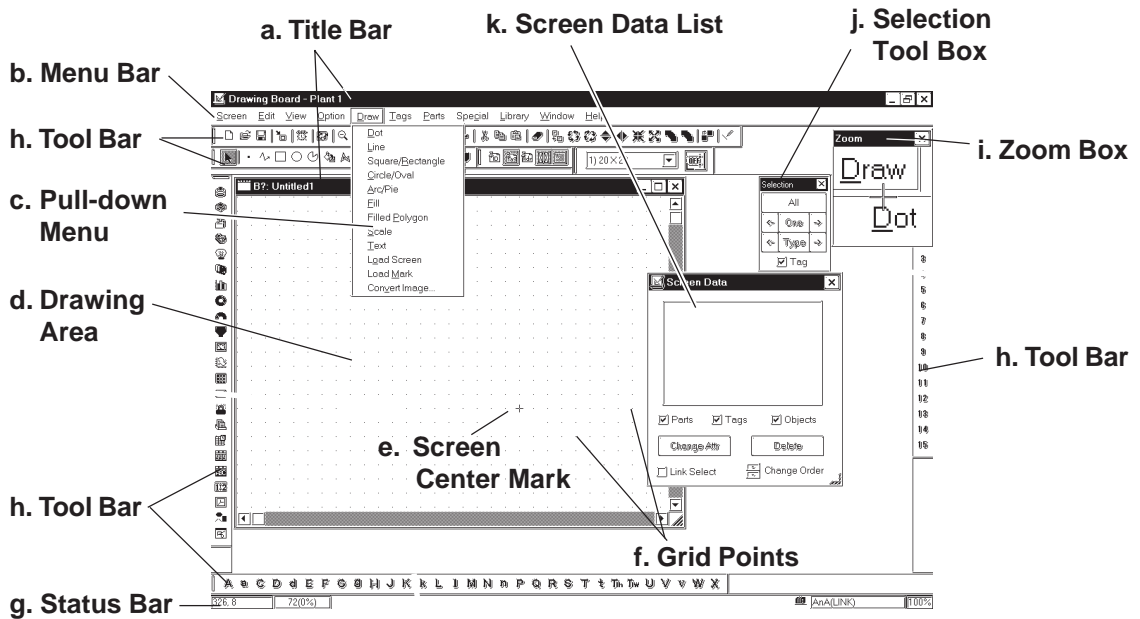

a. Title Bar

Displays the project file name, screen number and title.

b. Menu Bar

Displays the menus used to operate GP-PRO/PBIII for Windows. When you select a desired menu using the mouse or keypad, the pull-down menu (c) appears.

c. Pull-down Menu

When you select a desired menu from the menu bar, the pull-down menu appears. This menu includes various commands.

d. Drawing Area

Here, you can create a screen for your GP unit. The size of the screen you see here is designated via the “GP Type” setting you entered when you first created the project file.

Depending on the size of your PC’s display, the screen’s entire display area may not be displayed. In this case, simply scroll up or down to view the entire screen.

e. Screen Center Mark

Indicates the center of the screen. This mark is not displayed when the data is sent to the GP unit.

f. Grid Points

Used as reference points when you draw or paste an object in the drawing mode. Grid points will not be displayed on the GP unit's screen. The Option area's "Snap" function allows you to position your screen objects using a pre-made grid. You can also set the interval and display ON/OFF status of the grid points.

Reference 2.8.1 Grid/Snap**g. Status Bar**

Displays information related to the current screen and provides messages explaining the screen operation you are currently performing.

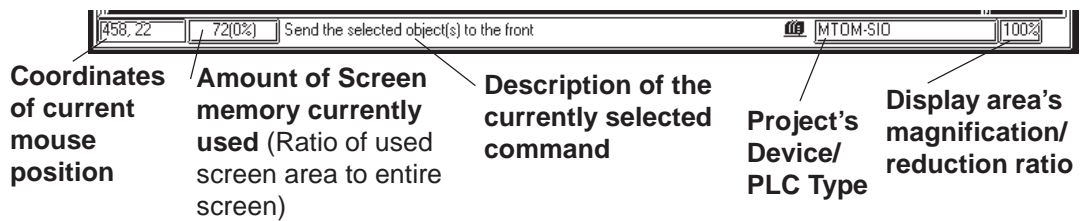
**h. Tool Bar**

The Tool Bar provides easy to use icons for drawing and editing. Clicking on one of these icons performs that command. The Tool Bar can either be hidden or displayed, and individual Tool Bar areas can be moved freely around the Screen Editor screen, i.e. top, bottom, left, or right.

The following Tool Bar areas are available:

- Main Tool Bar
- Edit Tool Bar
- Draw Tool Bar
- Option Tool Bar
- Grid/Snap Tool Bar
- Tag Tool Bar
- Parts Tool Bar
- Parts State Change Tool Bar

i. Zoom Box

Shows the cursor's current position at three times magnification.

j. Selection Tool Box

Used to select objects to be edited (Parts, Tags and figures). Using the commands included in this tool box, you can select objects using a variety of methods.



k. Screen Data List

Lists the settings and layout conditions of the objects (Parts, Tags and figures) that have been arranged on the screen. You can select a desired object from the list.

Reference 2.8.4 Screen Data List

1.3.2 Display Area (50%, 100%, 200%)

You can enlarge or reduce the drawing area by selecting a magnification/reduction ratio.

To change the display area, select the  or  icon on the tool bar, or select the [50%], [100%], or [200%] command from the [View] menu.

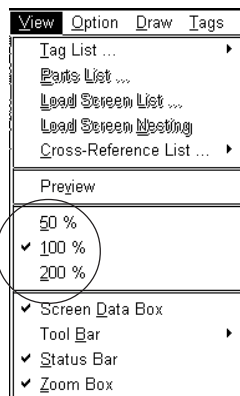

Zoom out **Zoom in**

Zoom out: Used to reduce the current display area to 50%.

Zoom in: Used to enlarge the current display area to 200%.



In the [50%] display mode, the created screen data is reduced. In this case, the displayed screen data may be different from the actual data. We recommend you to use a [100%] or larger display area.

1.3.3 Tool/Icon Display

The Tag tool box, Parts tool box, tool bar, and status bar can be designated as either shown (displayed) or not shown (not displayed). Each time you select the [View] menu's [Screen Data Box], [Status Bar], or [Zoom Box], as well as the [Tool Bar] command's [Main], [Edit], [Draw], [Option], [Grid/Snap], [Tag], [Parts], [Parts State Change] or [String Table] sub-commands, these View/Hide settings will toggle ON or OFF.

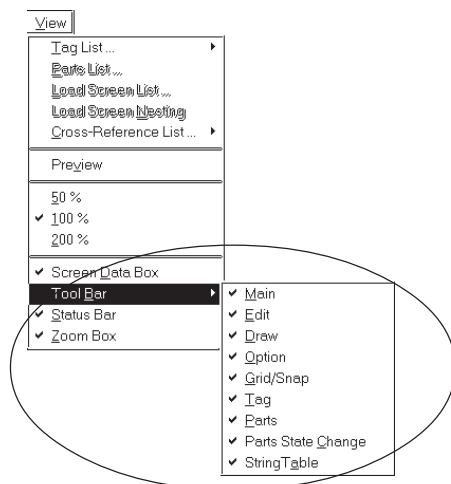

1.4

GP-PRO/PB III Manuals and Help

While you are learning how to use the GP-PRO/PBIII for Windows software, please refer to the following learning aids:

- Related User Manuals
- On-line Help Topics
- Digital's Home Page
- Power GP Q&A

For the help concerning the operation of the Windows operating system, see the Windows software's manuals and help screens.

■ Using GP-PRO/PBIII for Windows Manuals

The following manuals have been created for the GP-PRO/PB III for Windows software.

CD Jacket	Describes the system requirements, installation procedures for GP-PRO/PB III, and the method for reading the manuals in PDF format.
Operation Manual (This manual)	Provides detailed program operation information.
Tag Reference Manual	Provides detailed descriptions of this software's special and advanced functions.
Parts List	Lists all the pre-made Parts included in the GP-PRO/PB III for Windows software.
Device/PLC Connection Manual	Describes connection methods used between the GP and the host (PLC), as well as the necessary operating environment settings.

■ Using the Help Feature

If you have any problems or questions during GP-PRO/PB III for Windows operation, you can view the explanations for each feature and setting via each window's Help button, or from the main menu's Help feature.

■ Using the Home Page

Users can obtain the latest GP-PRO/PBIII for Windows information by accessing the Digital Electronics Corporation Home Page at "GP-PRO/PBIII for Windows Members Club".

1.4.1 Browsing Help Topics

To display the help screen, select the [Help] menu or click on the  button in the dialog box.



- **When multiple screens are loaded or many Tags and Parts have been registered on the screens, the PC's system memory may not be sufficient to display the help screen.**
- **If you jump from one topic to another on the help screen, an error message may be displayed. When this happens, simply quit and then re-start help.**

■ Searching for a Topic and then Display Help

Select the [Help Topics] command from the [Help] menu, or press the [F1] key. A list of help topics will be displayed.

You can search for a topic by either trying to find it from the table of contents, or entering a keyword for that topic.

◆ Searching for a Topic from the Contents Menu

To select a topic from the contents menu, double-click on the [Contents] tab. Follow the screen instructions to search for a desired topic.

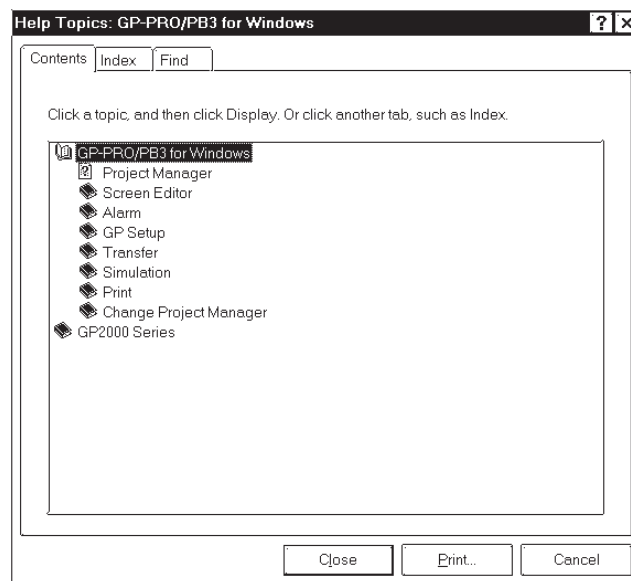

◆ Searching for a Topic by a Keyword

To enter a keyword, click on the [Index] tab.

Search for a desired topic according to the instruction indicated on the screen.

(When you enter initial characters of the keyword, the topics specified with these initial characters are also automatically listed)

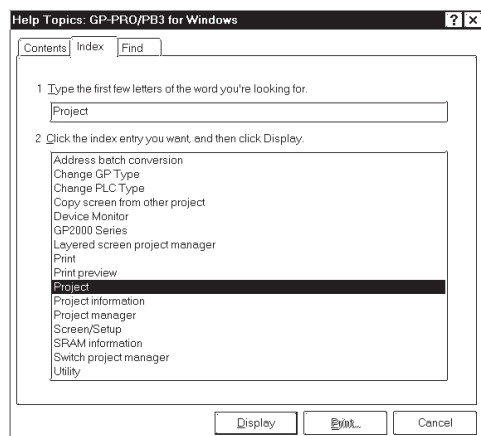

■ Calling up Help from a Dialog Box

When you click on the  button in the dialog box or press the [F1] key during execution of a command, a description of the currently-executed command will be displayed.



1.4.2 Browsing Home Page

The procedure to connect to Digital Electronic Corporation's home page "GP-PRO/PBIII for Windows Members Club" is described here.



- **To browse the home page, you must have hardware environment to access the Internet. You also must have a browser to view the home page, and subscribe to an Internet provider.**
- **To view the home page, register yourself as a user in "GP-PRO/PB III for Windows Members Club."**
- **Please understand that Digital Electronics Corporation cannot respond to any questions about your Internet connection.**

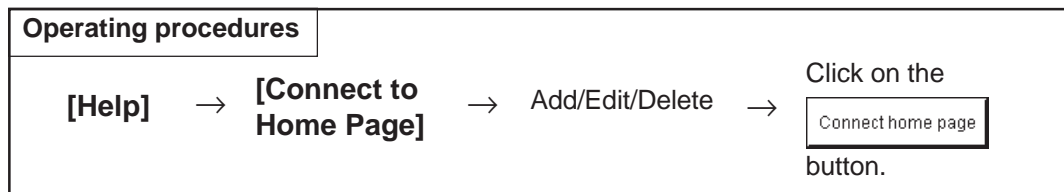

Outline of the Home Page Connection screen:

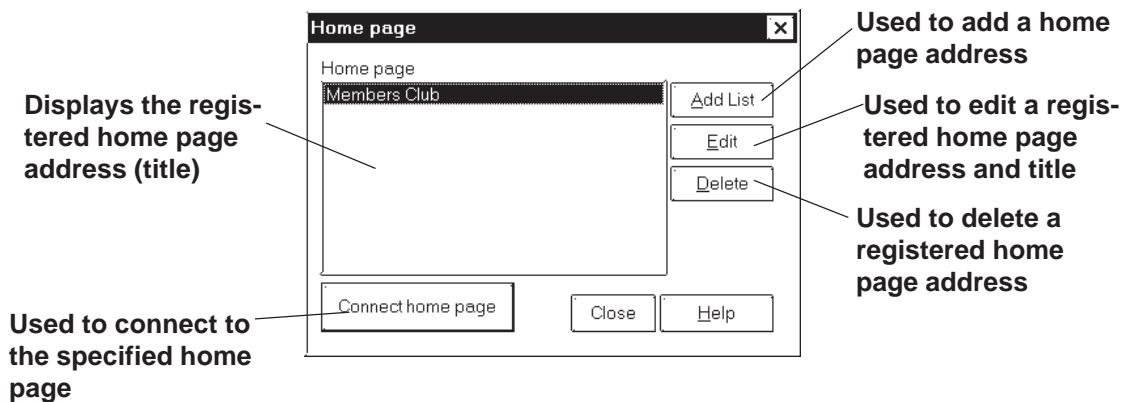

■ Registering a Home Page Address

The address of Digital Electronics Corporation's Home Page "GP-PRO/PBIII for Windows Members Club" has been preregistered in your GP-PRO/PBIII for Windows software. When you click on the Add List button, the address setting dialog box appears.

When you first visit the Member's Club page, you will be prompted for a registration number (from your software's User Registration Card), and will be given a password.

▼ Reference ▲ ■ How To Register a Home Page Address

■ Deleting a Home Page Address

Any registered home page address can be deleted. When you select the home page address to be deleted and click on the Delete button, the confirmation dialog box appears. If you click on the OK button, the selected home page address will be deleted. If you click on the Cancel button, the deleting operation will be canceled.



■Editing a Home Page Address

The registered home page address or title can be changed. When you select the home page address to be edited and click on the button, the address setting dialog box appears (same as for the home page addition procedure), enabling you to change the title and address of the home page. If Digital Electronics Corporation’s home page address is changed in the future, please edit the currently registered address.

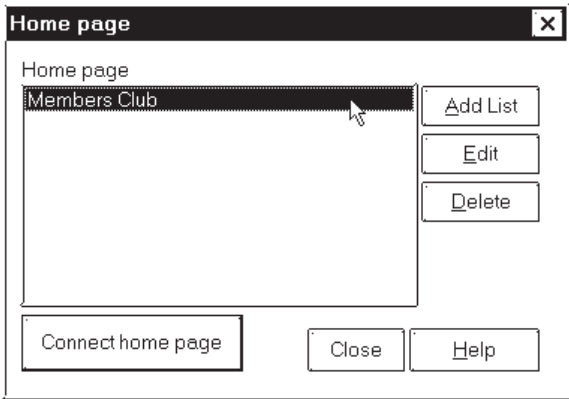
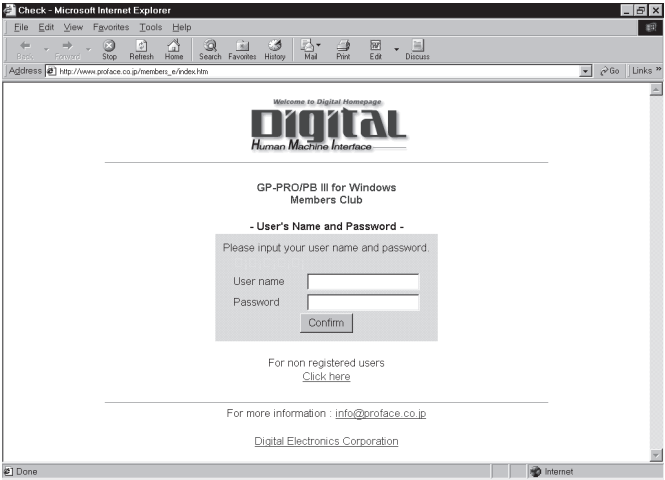
■Connecting to the Home Page

PROCEDURE	REMARKS
<p>(1) Select the [Help] menu - [Connect to Home Page] command in the Project Manager.</p> <p>(2) Select the target home page address.</p> 	
<p>(3) Click on the <input type="button" value="Connect home page"/> button to start connection.</p> <p>The browser is started, and you will be connected to the home page.</p> 	

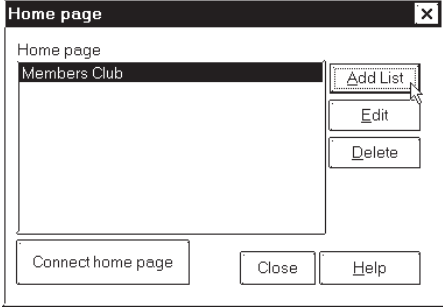
■ How To Register a Home Page Address

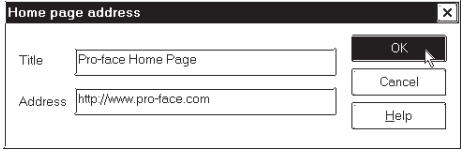
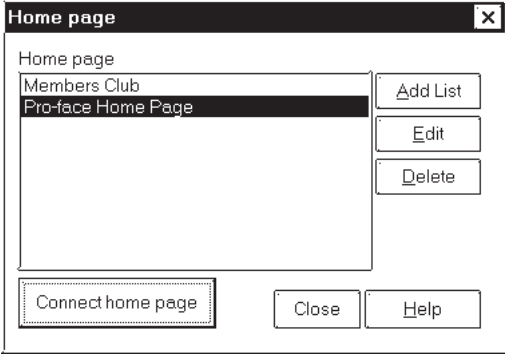
PROCEDURE	REMARKS
<p>(1) Select the [Help] menu - [Connect to Home Page] command in the Project Manager.</p> <p>(2) Click on the  button.</p>  <p>(3) Enter a home page title and address to be registered and click on .</p> <p>The specified home page address will be registered.</p>  <p style="text-align: center;">↓</p> 	

Memo

To create Base screens, the Editor area's Part, Draw, Tag, and Menu Bar commands can all be used. Also, Edit commands can be used to modify any Parts, objects or Tags that you have created. In addition to editing these screen objects, the procedures for registering Library Items and Windows are also explained.

2.1	Parts
2.2	Drawing
2.3	Tags
2.4	Object Editing
2.5	Libraries
2.6	D-Script/Global D-Script
2.7	Data Sampling
2.8	Efficient Drawing Techniques
2.9	Creating Handy-type GP Screen
2.10	DXF Conversion







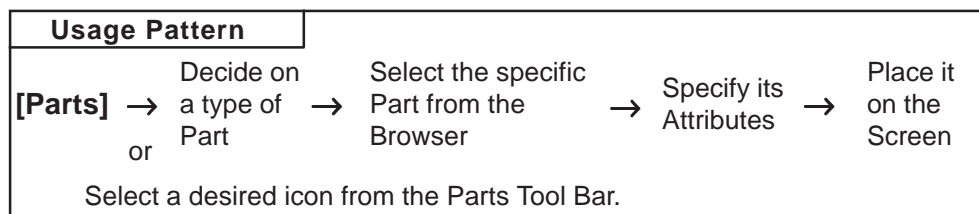







2.1 Parts









Each Part's attributes such as setting Addresses and colors will be designated via the dialog box. After designating all the necessary Part attributes, decide their position and size on the object drawing area.

The [Parts] menu's commands are effective only on Base screens.



■GP-PRO/PBIII for Windows Part Type List

Icon	Name	Function	Reference
	Bit Switch	Used to change a PLC's Bit Address data.	2.1.1 Bit Switches
	Word Switch	Changes a PLC's Word Address data.	2.1.2 Word Switches
	Function Switch	Used to go back to the previous screen, to switch screens, and to reset the GP.	2.1.3 Function
	Toggle Switch	Turns the PLC's Bit Address ON or OFF.	2.1.4 Toggle
	Lamp	Turns ON or OFF according to the PLC's Monitor Bit.	2.1.5 Lamps
	4-State Lamp	Switches the 4 states of the lamp, according to whether the PLC's two Monitor Bits are ON or OFF.	2.1.6 4-State Lamps
	Bar Graph	Displays the PLC's Word Address data in a bar graph.	2.1.7 Bar Graphs
	Pie Graph	Displays the PLC's Word Address data in a pie graph.	2.1.8 Pie Graphs
	Half Pie Graph	Displays the PLC's Word Address data in a Half-Pie graph.	2.1.9 Half Pie Graphs
	Tank Graph	Displays the PLC's Word Address data as absolute values in a Tank graph.	2.1.10 Tank Graphs
	Meter	Displays the PLC's Word Address data a Meter.	2.1.11 Meters
	Trend Graph	Displays the PLC's Word Address data as absolute values in a trend graph.	2.1.12 Trend Graphs
	Keypad	Used to enter a PLC's Word Address data.	2.1.13 Keypads
	Keypad Input Display	Displays data input via the keypad.	2.1.14 Keypad Display

Icon	Name	Function	Reference
	Alarm Display	When monitored Bits are turned ON, a list of "Basic" Alarm summary messages appear that have been previously registered in the Alarm Editor.	2.1.15 Alarm Display
	Filing Data Display	Displays data registered in the Filing Data list by specifying the corresponding file number.	2.1.16 File Name Display
	Logging Display	Displays PLC data loaded in the data logging settings by specifying the address for the corresponding block number.	2.1.17 Data Logging Display
	Numeric Display	Displays the PLC's Word Address numeric data as an absolute value.	2.1.18 Numeric Displays
	Message Display	Displays a previously registered message, according to PLC Word Address data changes. A maximum of 16 messages can be displayed in a single Message Display.	2.1.19 Message Display
	Date Display	Displays the current date, using the GP's internal calendar.	2.1.20 Date Displays
	Time Display	Displays the current time, using the GP's internal clock.	2.1.21 Time Displays
	Picture Display	Displays a single registered Library image (only graphic data), according to PLC Word Address data changes. A maximum of 16 different Library images can be displayed in a single Picture Display. (One at a time)	2.1.22 Picture Displays
	Window Parts	Windows created on the Window Screen (U) can be called up on the Base Screen (B).	2.1.23 Window Parts

■ Entering a Comment

If desired, a comment can be entered for a Part.

Up to 20 alphanumeric (single-byte) characters or 10 Chinese (double-byte) characters can be entered

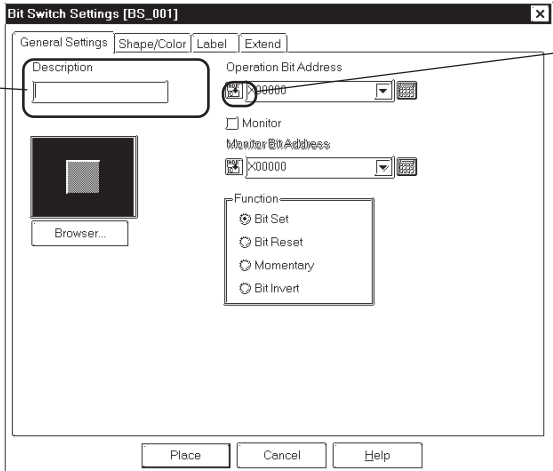

Applies the device comment

◆ Reflection of a Device Comment

If you click on the  [Apply Device Comment] button after entering an address, the device comment entered using the Symbol Editor is automatically searched for, and the comment corresponding to the entered device appears in the Description field.

▼ Reference ▲ 4.7 Symbol Editor

■ Entering Addresses

Here, Addresses that are operated for Parts' functions and that are monitored are designated.

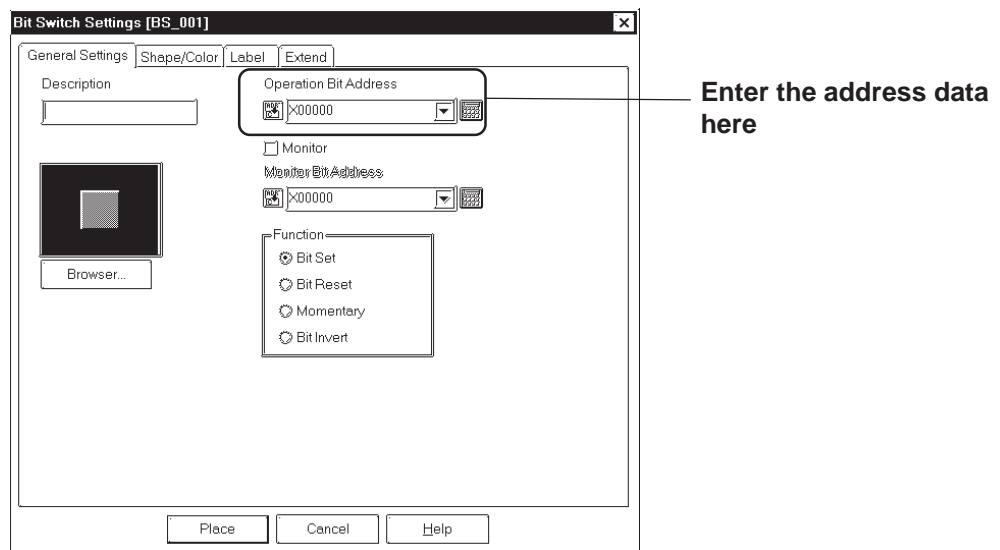

◆ Entering from a keyboard

Click on the address entering field, and the cursor will appear there, which indicates data entry is now effective. Then, enter device and address data via the keyboard.

◆ Entering from an address keypad

Click on the address keypad icon, and the address keypad will appear, allowing you to enter numeric data and addresses on the screen via the mouse.

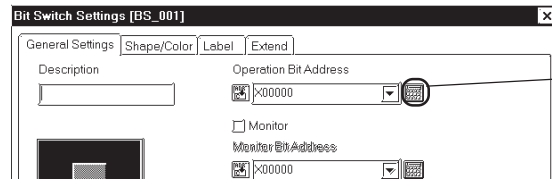

To move the address keypad to the desired position, drag its title bar.

To display the device names in a list, click here.

Backspace key
Hexadecimal number entry key

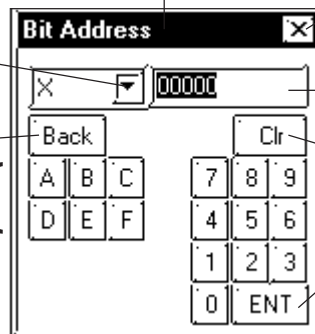

To close the address keypad, click here.

Display
Clear key
Enter key

◆ Entering from a pull-down list

Click on the  box next to the Address entering field, and a pull-down list appears including symbols selected via the Symbol Editor and device comments together with corresponding Addresses. Selecting a symbol or device comment from the list designates an Address.

▼ **Reference** 4.7 *Symbol Editor*

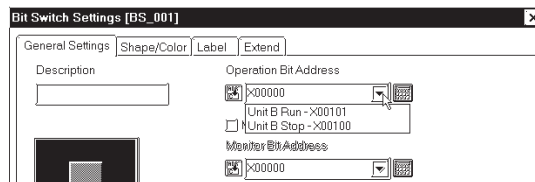

Note: A Part's specified address can be entered so that it is displayed during Base screen creation.

▼ **Reference** 2.8.2 *Screen Property Settings*

Regardless of whether addresses are designated as either displayed or not displayed during Base screen creation, they will not be displayed on the GP panel after screen transfer.

■ Selecting a Part Shape

Click on the General Settings Area's button in the dialog box, and the Shape Browser (hereafter called "Browser") will be displayed. The Browser's Part Shapes are stored in a Part File (PDB file or BPD file), separate from the main Project File (PRW file). Searching through different pre-made Part files allows you to easily find useful Part Shapes for almost any application.



Note: Parts (image parts) stored in BPD file is corresponding to GP2000 series only.

Click on a Part number and then the button, or double-click directly on the Part number to select a Part Shape. (Browser disappears)



Note: Part File and Part Shape lists for each file are included in the GP-PRO/PBIII for Windows Parts List Manual.

The ID number of the Part Shape is displayed here. Reverse video (highlighting) indicates it is selected

Shows the ID number of the currently selected Part Shape

Shows the Part name of the currently open Part File

Clicking here scrolls through the Part Shapes in this file

Click here to register custom image parts.

Deletes custom image parts created by the user.

Calls up a list of the other Part files

◆ Parts Files

Two types of part files can be used: PDB files and BPD files.

Select the parts best suited to your application from the applicable files.



• Use the parts included in BPD files (image parts) for switches and lamps. However, these parts cannot be used for Toggle Switches or 4-State Lamp settings.

• The Image Parts feature is supported only by the GP2000 Series.

Click on the button and a list of the Part files will appear. After clicking on a Part File, the information displayed will change to reflect that file. Next, click on the button and the selected Part file's Part Shape will appear in the Browser.

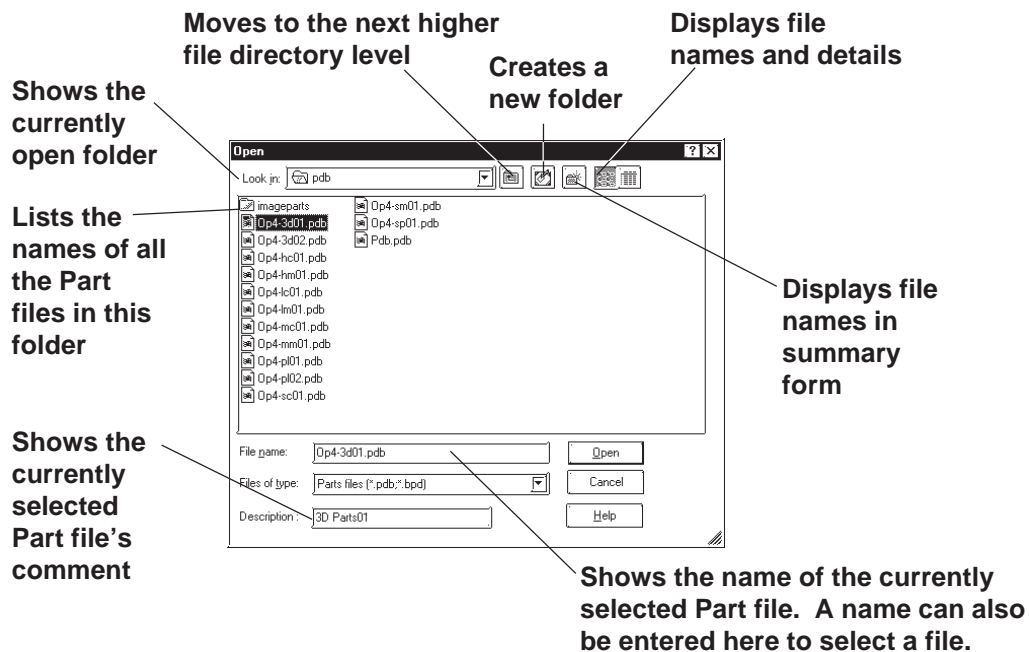

- The BPD file is located in the [imageparts] folder in the [PDB] folder.
- Part files (PDB File/BPD File) are automatically installed in a folder named "PDB" when GP-PRO/PB III is first installed. If desired, these files can be installed in other folders instead. To display part shapes located in other folders, use the [Look in:] area to switch to the applicable folder.

<Differences between the PDB File and BPD File>

	Preprogrammed File	Registration/ Deletion by Users	Color Setting Adjustment
PDB	m	X	m
BPD	m	m*1	X

*1: A preprogrammed BPD File cannot be registered or deleted.

◆ **Registering Image Parts**

Image files in bitmap file format and JPEG file format can be registered in the BPD File as Image Parts for switches and lamps (except for Toggle Switches and 4-State Lamps). Image files can be specified separately as either ON and OFF.

Click the **Create** button in the Shape Browser dialog box. The dialog box for registering Image Parts will appear.

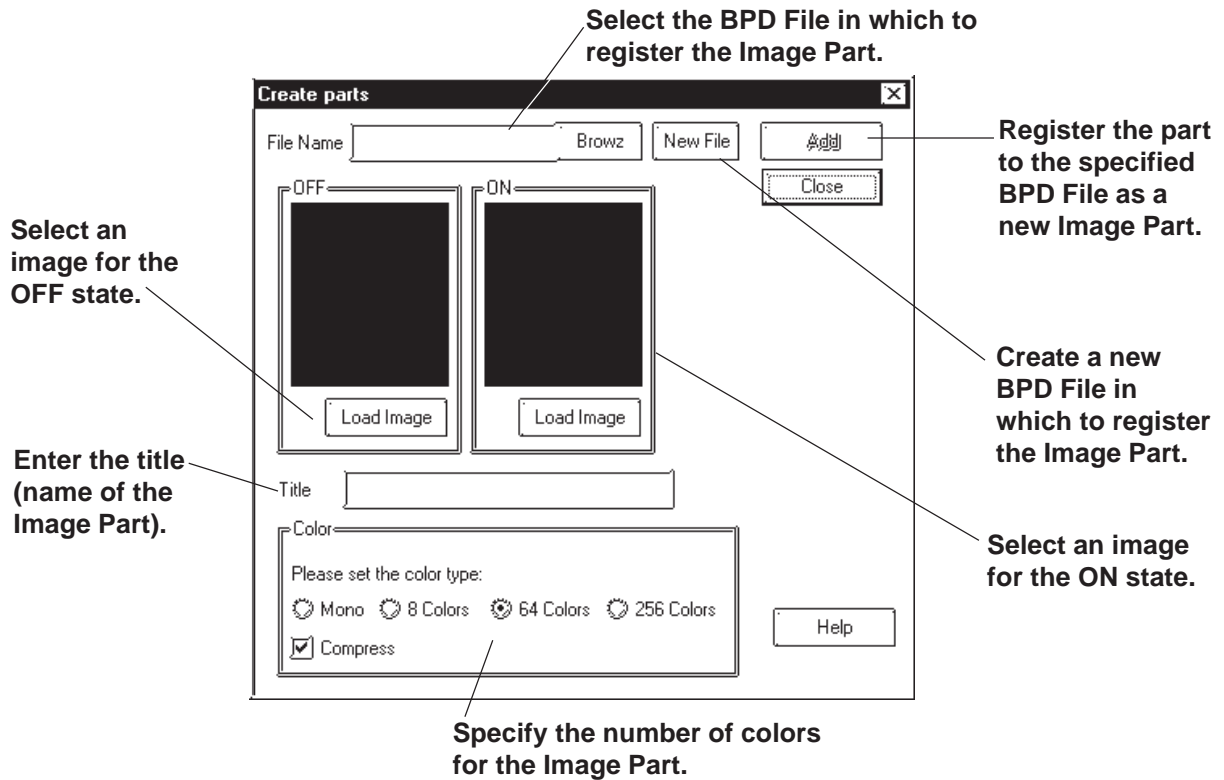



The following table shows the types of image files that can be registered.



Number of colors	1 bit		4 bits		8 bits		16-bit color	24-bit color	32-bit color
	2 colors (black & white)	16 colors	16-level gray scale	256 color	256-level gray scale				
Windows BMP/DIB	*.BMP	○	○	○	○	○	○	○	○
Windows BMP/DIB(RLE4)		-	○	○	-	-	-	-	-
Windows BMP/DIB (RLE8)		-	-	-	○	○	-	-	-
JPEG	*.JPG	-	-	-	-	○	-	○	-

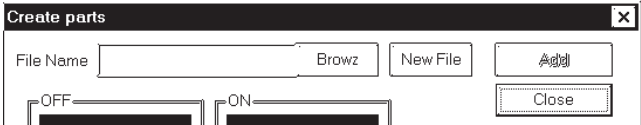

- Image Parts can be registered to a maximum size of 160 x 160 (dots).
- Image Parts will increase the size of the Project file. We recommend enabling the "Compress" setting in "Color" settings.
- Up to 200 Image Parts can be registered in a single BPD File.
- Before registering the Image Part, select image files for both ON and OFF states.
- When the sizes of the images for the ON and OFF states differ, the smaller image is magnified to equal the size of the larger image.
- Image Parts that are zoomed in or zoomed out may appear slightly different on the GP screen than from the PC screen.

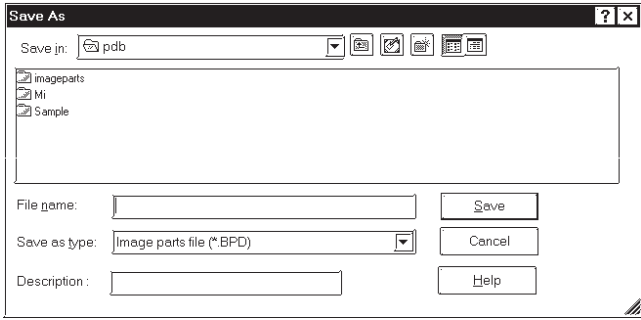
This section describes the procedure for registering Image Parts in the BPD File.

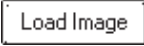
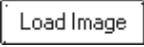
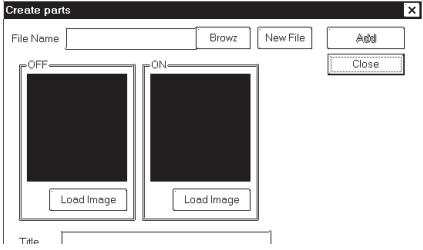
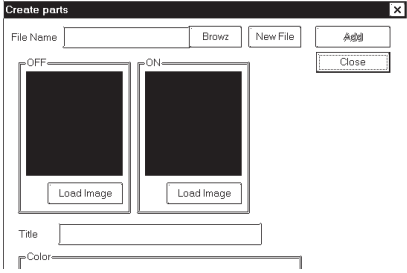
PROCEDURE	REMARKS
<p>(1) Click the  button in the Shape Browser dialog box.</p> <p>(2) Specify the location for registering the Image Part.</p> <p>[Register the Image Part in an existing BPD File.]</p> <p>a) Click the [Browz] button and select the BPD File in which to register the Image Part.</p>  <p>b) Press the  button to confirm the destination file for registering the Image Part.</p> <p>[Register the Image Part to a new BPD File.]</p> <p>a) Click the  button.</p> 	

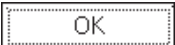
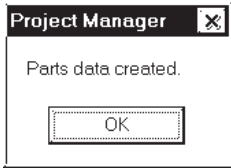
PROCEDURE	REMARKS
<p>b) Specify the file name of the new file. In the "File Name" area, enter the file name of the destination BPD File.</p> <p>In the "Description" area, enter the category name of the BPD File as well as any remarks that may be useful as notes.</p> <p>c) Press the  button to confirm the destination file for registering the Image Part.</p> <p>(3) Select an Image Part for the OFF state. Click the  button and specify the desired bitmap image.</p>  <p>(4) Select an Image Part for the ON state using the procedure described in step (2).</p> <p>(5) In the "Title" area, enter the name of the Image Part.</p>  <p>(6) In the "Color" area, specify the display color for the Image Part.</p> <p>(7) Click the  button.</p> <p>(8) Click  to complete the registration.</p> 	<p>Image Parts can be registered to a maximum size of 160 x 160 (dots).</p> <p>Before registering the Image Part, select image files for both ON and OFF states.</p> <p>Image Parts will increase the size of the Project file. We recommend enabling the "Compress" in "Color".</p>

■ Selecting Colors

Specify Part colors using the Shape/Color setting screen. The setting items will differ depending on the Part, i.e. the border type, ON/OFF states, graphs, and label colors.

Tiling patterns can be selected for some of the Parts, Lamps, and Graphs.



Note: Specific colors are pre-assigned to each Image Part (BPD File) when it is selected from the browser. Color settings cannot be modified.

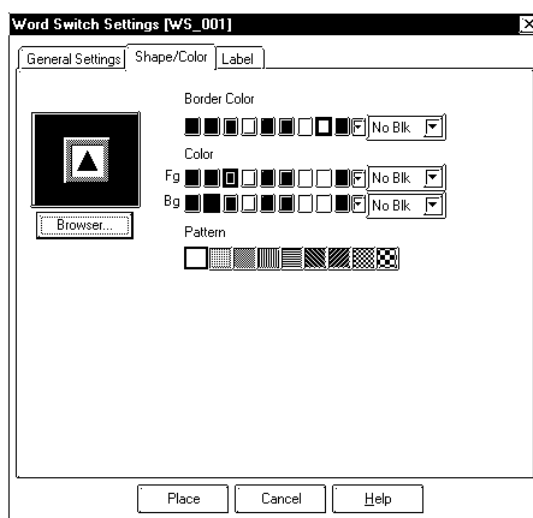

◆ Colors

Color setting methods will differ for each model, i.e. monochrome, 8-color, 64-color and 256-color settings.

64-color model : GP-571T, GP-675S, GP-675T, GP-377S, GP-377RT, GP-577RS, GP-577RT, GP2000 series (except GP-2301HL, GP-2300L and GP-2301L)

256-color model: GP2000 series (except GP-2301HL, GP-2301HS, GP-2300L, GP-2301L, GP-2301S and GP-2501S)



- **Do not transfer a Project File created using 64-color (256-color) data to a 64-color (256-color) incompatible GP panel. The 64-color (256-color) data may be automatically changed to monochrome data and some object elements, such as fills or patterns, may not be displayed as they were originally drawn.**
- **Pro-face recommends of using the basic 8 colors (on the color bar). Objects and image data created using colors (on the color palette) other than the basic 8 colors may flicker.**

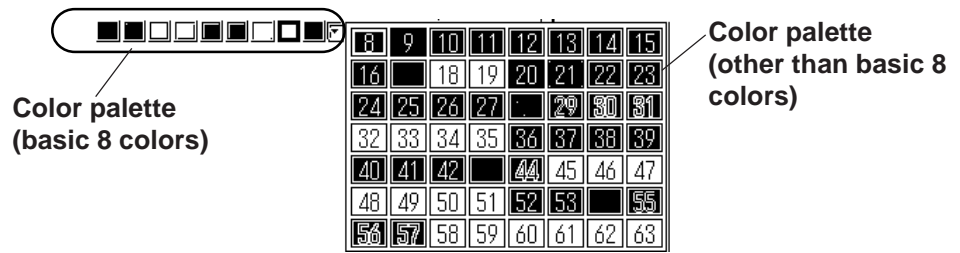

<When using an 8-color or monochrome GP unit (incompatible with 64-color screens)>

There are 8 colors available in the color bar. Use this bar to select the foreground (Fg), background (Bg) and other colors. On a monochrome GP screen, black, blue, green, and cyan will be displayed as black (same as background); red, magenta, yellow, and white will be displayed as white.

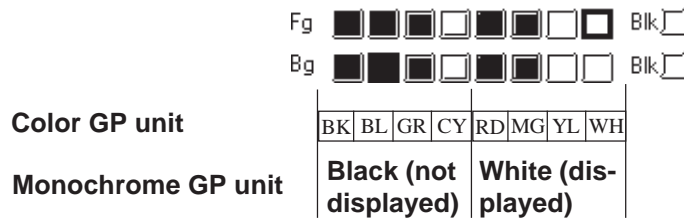

<When using a 64-color GP unit>

There are 64 colors available via the color palette. Use the palette bar to select the foreground (Fg), background (Bg) and other colors.

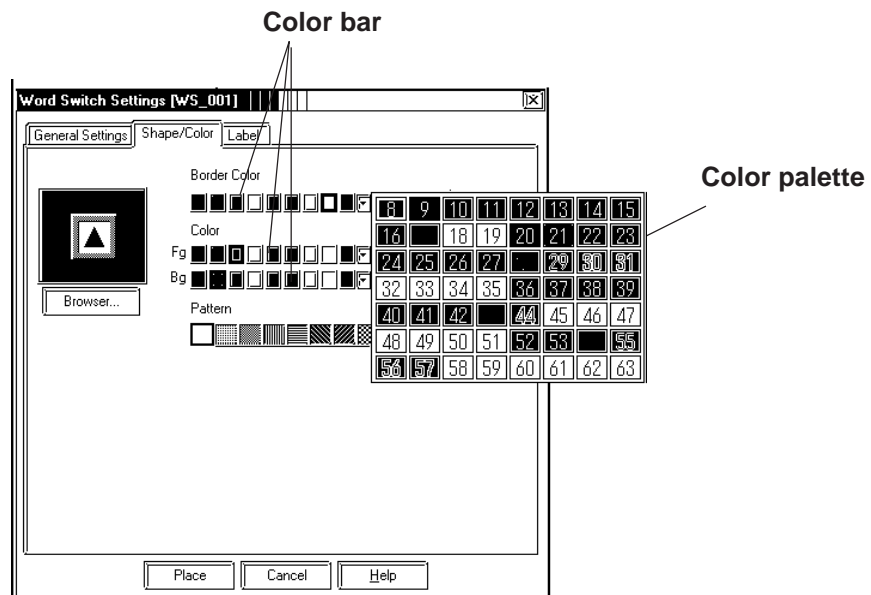

After converting 64 color data to 8 color data, each color will be displayed like this:

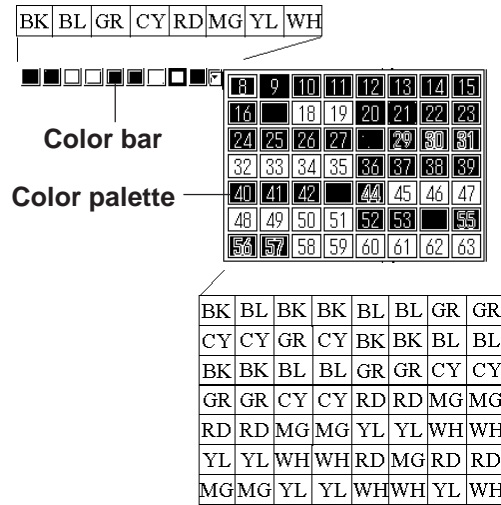

After converting 64 color data to monochrome data, each color will be displayed like this:

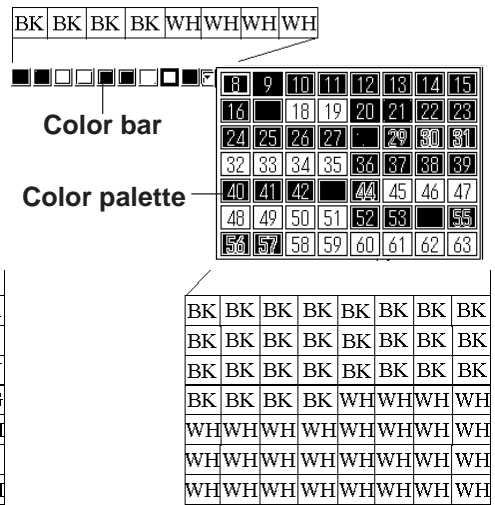

<When using a 256-color GP2000 series unit>

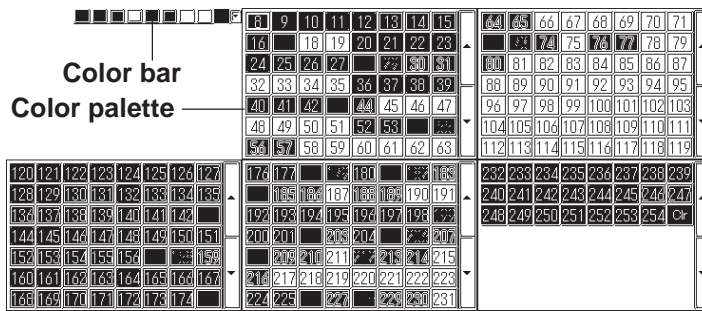

The following tables describe the changes in the display when the GP type is changed from a 64-color model to a 256-color model.

64-color No blink

0	1	2	3	4	5	6	7
8	9	10	11	12	13	14	15
16	17	18	19	20	21	22	23
24	25	26	27	28	29	30	31
32	33	34	35	36	37	38	39
40	41	42	43	44	45	46	47
48	49	50	51	52	53	54	55
56	57	58	59	60	61	62	63

64-color Blink

0	1	2	3	4	5	6	7
8	9	10	11	12	13	14	15
16	17	18	19	20	21	22	23
24	25	26	27	28	29	30	31
32	33	34	35	36	37	38	39
40	41	42	43	44	45	46	47
48	49	50	51	52	53	54	55
56	57	58	59	60	61	62	63

64-color Fast

0	1	2	3	4	5	6	7
8	9	10	11	12	13	14	15
16	17	18	19	20	21	22	23
24	25	26	27	28	29	30	31
32	33	34	35	36	37	38	39
40	41	42	43	44	45	46	47
48	49	50	51	52	53	54	55
56	57	58	59	60	61	62	63

64-color Slow

0	1	2	3	4	5	6	7
8	9	10	11	12	13	14	15
16	17	18	19	20	21	22	23
24	25	26	27	28	29	30	31
32	33	34	35	36	37	38	39
40	41	42	43	44	45	46	47
48	49	50	51	52	53	54	55
56	57	58	59	60	61	62	63

◆ **Blink**

Blink settings will also differ slightly depending on whether a single speed Blink GP model or a three speed Blink GP model is used. Digital's three speed blink models are the GP-571T, GP-675S, GP-675T, GP-377S, GP-377RT, GP-577RS, GP-577RT and GP2000 series units (except GP-2301HL, GP-2300L and GP-2301L). Other GP models have only one blinking speed. When 256-colors are selected in a project, the "Blink" feature cannot be used for any of that project's screens.

<Using a three speed Blink type GP>

Next to the Check Box, there is a Button that will display a range of 3 speeds and "No Blk" (indicates no blinking). When one of the blink speeds is selected, the color bar is displayed in a darker color and the specified Part will blink on the GP screen.

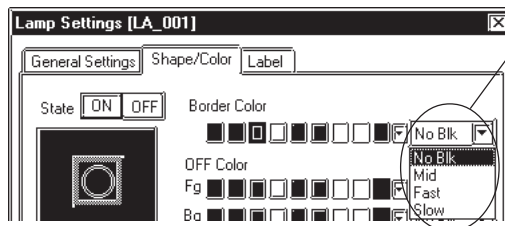

Blink speed settings

The normal blink speed is "Mid." "Fast" is twice as fast as "Mid" and "Slow" is half as fast as "Mid". When "No Blk" is selected, the Part will not blink.

<Using a single speed Blink type GP>

When the Blink (Blk) Check Box checked , the color bar is displayed in a darker color and the specified Part will blink on the GP's screen.



Blink Check Box

When the GP model is changed from a three speed Blink type to a single speed type, the "Mid" and "Slow" speeds will be changed to the single speed GP's "Blink" speed, and "No Blk" and "Fast" will be changed to "No Blk". The blinking rate for a single speed GP model is equal to the "Mid" setting of the three speed type.

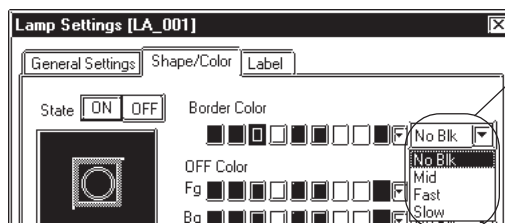

No Blk	No blink
Mid	Blink
Fast	No blink
Slow	Blink



Transparent mode can be selected as the background color (Bg) text and Mark objects. This function is useful when overlaying text on Switches, Lamps, and other objects.

For example: Change the background color of the label from "Black" to "Transparent".

Label

Switch →

The background color of the label is black.

The background color of the label becomes transparent.

<All models>

Bg [Color Bar] Blk

Specify the background color of the label as "Black" only.

<Non-256-color models>

Bg [Color Bar] Blk

Specify the background color of the labels as "Black and Blk (Blink)".

*On 64-color models, this feature is enabled only when the "Mid" blink speed is selected.

<256-color models>

Specify the background color of the labels as "Clr".

232	233	234	235	236	237	238	239
240	241	242	243	244	245	246	247
248	249	250	251	252	253	254	Clr

◆ States

Only Parts which can have two states are displayed with this feature. Display colors for Parts can be specified separately for each state; for example, a Bit Switch can be displayed as red in the OFF state and green in the ON state. Click on either state button to select it, and specify that state's color using the color bar.

■ Alarm Settings

In both graph and numeric value displays, Alarms can be set up. First, click on the [Alarm Settings] tab at the top of the Dialog box. When checking the Alarm Display box (Check mark appears), the Alarm setting items will appear.

Bar Graph Settings [BA_001]

General Settings | Graph Settings | Shape/Color | Alarm Settings

Alarm Display

Alarm Range

Min. Value: 0

Max. Value: 100

Alarm Type

Direct

Indirect

Alarm Color

Fg [Color Bar] No Blk

Bg [Color Bar] No Blk

Place Cancel Help

Sets the Alarm value's Format to fixed or variable

Sets the minimum and maximum Alarm values

Sets the Alarm colors used

◆ Alarm Type

The Alarm value can be specified as either direct (fixed value) or indirect (variable value) by simply clicking on the appropriate circle.

◆ Alarm Range

Here, you can specify the maximum and minimum Alarm values. When the Alarm value has been specified as indirect, the maximum and minimum values can also be specified as indirect. In this case, the Word Address number used to store these values will be automatically assigned continuously from the Word Address currently specified. The following example uses “n” to denote where the Word Address’ display data is stored:

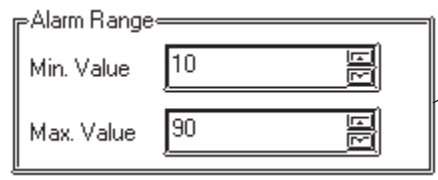

Word Addresses are automatically allocated in sequence, starting from the Address designated

<Relationship between display data’s storage address and Alarm register address>

With 16 Bit data

n	Display Data
n+1	Data value - Max.
n+2	Data value - Min.

With 32 Bit data

n	Display Data
n+1	
n+2	Data value - Max.
n+3	
n+4	Data value - Min.
n+5	

◆ Alarm Color

Here, you can select the colors used for an Alarm display.

▼ **Reference** 2.1 Parts ■ *Selecting Colors*

■ Creating Labels

Here, a Label means the text characters shown on the faces of the Switch and Lamp button Parts. Labels can be registered via the Part’s Setting dialog box.



As with Parts, Label display colors can be created for each of a 2-state Part’s states; up to 4 lines of text can be used for each state.

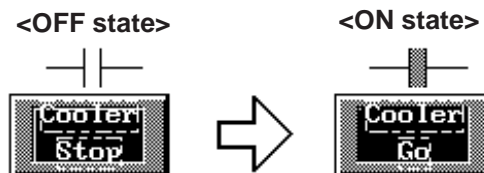

When a lamp’s Text Display changes (This Switch’s ON/OFF colors are also selected)



Note: The Part must be large enough to display the entire Label.

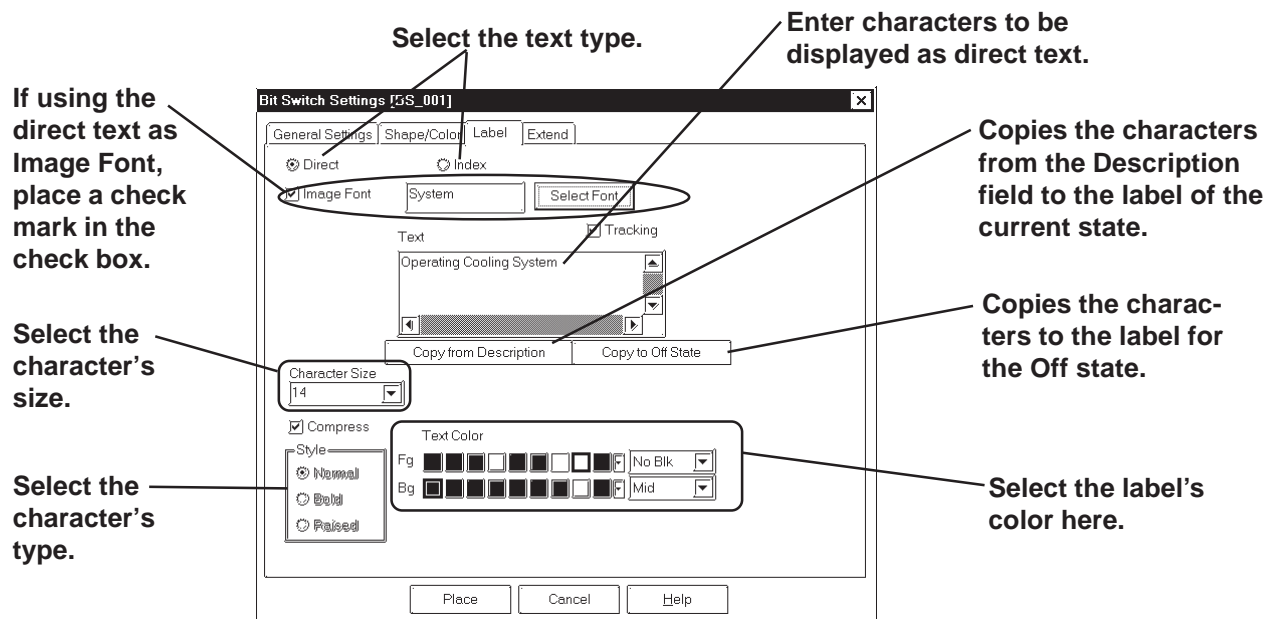

◆ Direct Text

The text entered in the text entry field is placed directly as a fixed text string.

◆ Index Text

Select and add the index text.

▼ **Reference** ▲ 4.6.3 ■ *Selecting the index character string* ◆ *Entering the index character string*

◆ Image fonts

Windows fonts are displayed in bitmap format.

This feature is enabled only when the "direct text" mode is selected.

▼ **Reference** ▲ 2.2.9 *Text* ◆ *Image Font*



Note: The Image Font is supported only by the GP2000 series.

◆ Label

Here, you can type in the text displayed on a button. When typing in text, press the  key to move to a new line. When the [Tracking] check box is checked (enabled), after the Part has been placed on the screen, if the Label's size or position is changed, for either state, the alternate state's Label size and position will be also automatically changed. If, however, the Label's size and position need to be specified independently for each state, DO NOT check this box. ▼ **Reference** ▲ 2.4.3 *Scaling Up/Down*

◆ Copy from Description

The characters entered in the Description field are copied to the label in the selected state.

◆ **Copy to Off (On) state**

When the state is On, the characters entered in the label are copied to the label in the Off state. When Off, the characters are copied to the label in the On state.

◆ **State**

States are displayed only for Lamps, and for those switches with two states (ON and OFF). The text displayed for each state can be specified independently. Simply click on either state button to specify its text and colors.

◆ **Character Size**

Specifies the size of character.

▼ **Reference** 2.2.9 Text

◆ **Style (Font)**

Specifies the type of character (Normal, Bold, Raised) used in each Label.

▼ **Reference** 2.2.9 Text

◆ **Text Color**

Specifies Label colors.

The default settings are Fg: White, and Bg: Transparent mode (Black + Blk).

◆ **Alignment (Justification)**

When the text input for a Label exceeds one line, the Alignment icons will appear. Select Left, or Right justification, or Centering.

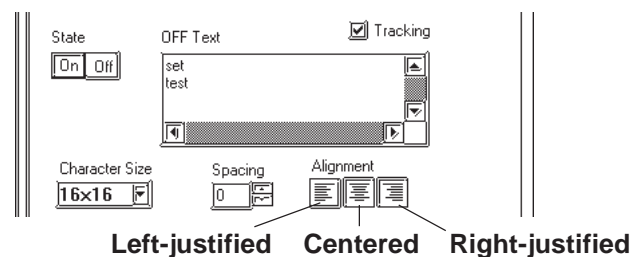

■ ID Numbers

When creating a Part, an ID number is automatically assigned to the Part before it is placed on the screen. This number shows how many of that kind of Part were previously placed on the current screen. When a Part is deleted from a screen, all following Part numbers will be adjusted downwards.

Example of an ID number

BS _ 010

Indicates that this Part is a Bit Switch
(Varies according to the Part)

Indicates the placement/
creation order of the Part; in
this case, it is the 10th.

The ID number is displayed in the title bar at the top of the Setting dialog box.

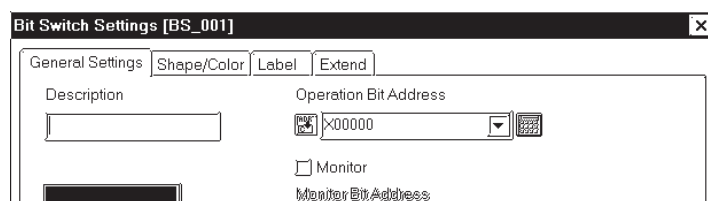

- The ID number can be entered so that it is displayed during Base screen drawing. **Reference** 2.8.2 Screen Property Settings

Even if the ID number is entered to be displayed during Base screen drawing, it will not be displayed on the GP panel after screen data transfer.

<ID Number List>

Part Name	ID Number	Part Name	ID Number
Bit Switch	BS-**	Keypad	KE-***
Word Switch	WS-***	Keypad Input Display	KD-***
Function Switch	FS-***	Alarm Display	AL-***
Toggle Switch	TS-***	File Name Display	FD-***
Lamp	LA-***	Data Logging Display	LG-***
4-state Lamp	LF-***	Numeric Display	ND-***
Bar Graph	BA-***	Message Display (Operation Mode: Bit)	MB-***
Pie Graph	PI-***	Message Display (Operation Mode: Word)	MW-***
Half-Pie Graph	HP-***	Date Display	DD-***
Tank Graph	SG-***	Time Display	TD-***
Meter	MT-***	Picture Display (Motion mode: Bit)	LB-***
Trend Graph	TR-***	Picture Display (Motion mode: Word)	LW-***
		Window Parts	WI-***

■ Maximum Number of Automatically Created Part Libraries

When a Part is used in a project, a Part Library will be automatically created in preparation for data transfer. The number of Part Library items are limited to 6000 per project. If this number exceeds 6000, all Parts in excess of 6000 cannot be transferred to the GP. To avoid this, please remember the following:

1. Automatic Library creation will be performed follows: (per screen)

Switches:	2 (only switches with the Monitor function selected)
Lamps:	2
Messages:	2 to 16 (depending on the number of states used)
Picture Displays :	2 to 16 (depending on the number of states used)
Trends:	1 to 20 (depending on the number of channels)

However, Part Libraries using the same Parts (i.e. Part's that are the same size, same attributes, and without labels or other items) will be used commonly.

For example:

When 30 Switches (Monitor function is selected) and 20 Lamps are placed on a single Base screen, $(30 \times 2) + (20 \times 2) = 100$ Part Library items will be automatically created. Therefore, 60 of these size screens can be used in one project('s data).

2. When using the same Parts for multiple Base screens, register the Part on one Base screen and then place it other Base screens using the Load Screen function. Thus, when multiple Base screens use those Parts, only one Part Library will be used, thereby reducing the Project File's size.

■ **Placing a Part in Position**

After all of a Part’s attributes have been entered or selected, click on the desired position on the screen to place the Part.

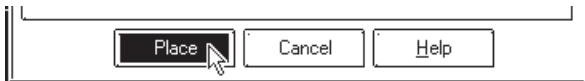
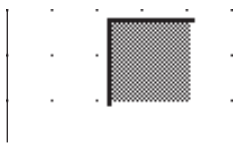
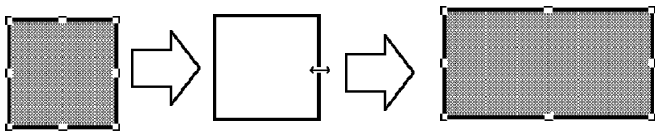
PROCEDURE	REMARKS
<p>(1)After all of a Part’s attributes have been entered or selected, click on the  button. The Part’s outline will appear on the Base screen, next to your cursor.</p> 	
<p>(2)Click on the point where the Part’s top left corner is to be placed. The selected Part will then appear on the screen.</p> 	
<p>(3)Adjust the Part’s size, if desired. Click on the Part to select it, and drag any one of the handles to change the size of the Part. To change the size of a Part, move the cursor to a Part “handle” and click, then drag the “handle” to re-size the Part, and click again.</p> 	<p>▼ Reference ▲ 2.4.3 <i>Scaling Up/Down</i></p> <p>After placing the Part, double-clicking on it automatically brings up its Attribute Setting dialog box.</p> <p>▼ Reference ▲ 2.4.14 <i>Changing Attributes</i></p>



Depending on the Part, when scaling up or down, a one dot error may occur in the frame width.

E.g.)



2.1.1 Bit Switches

Here, the creation of a touch panel switch, used for turning a specified Bit ON or OFF, is explained.



If the GP unit has not been connected to the host PLC, Bit Switches with the Monitor function selected will not be displayed on the GP unit after the Project File transferred.

■ Bit Switch [General Settings] Attributes

Enter comment data here

Image of the currently selected Part Shape

Calls up the Part Shape Browser where a different Part Shape can be selected

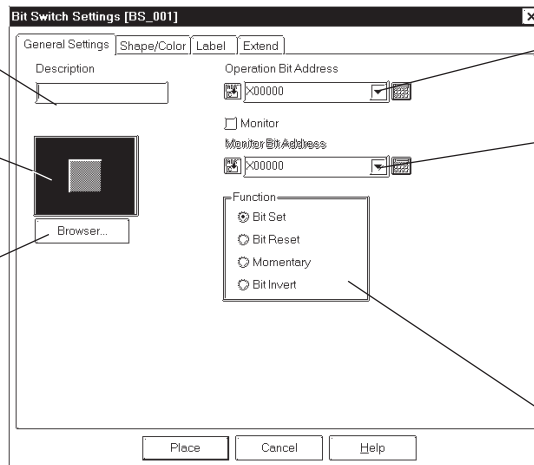

Enter the Bit Switch Address

When creating a Bit Switch with two states, check this box and enter the alternate Bit Switch Address below

Select the switch's function

◆ Operation Bit Address

Here, the Bit Address data controlled by the Switch is input.

◆ Monitor Bit Address

Only after the Monitor check box is checked can the Monitor Bit Address used to change the Switch's display setting be entered. The Switch's state (ON/OFF) display can be specified so that it will change according to changes in this Bit Address. Addresses input in the Bit Address area can also be done here.

Appears only when creating a Bit Switch with two states. Toggles the switch's state either ON or OFF, allowing you to set the attributes of each state

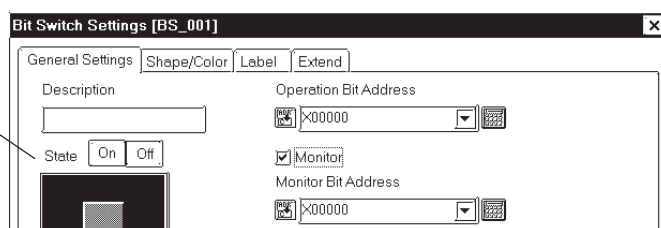

After entering the Bit Address, if you attempt to perform another area's operation before entering the Monitor Bit's address data, the dialog box shown below will appear. Clicking on the button automatically inputs the Bit Address's data into the Monitor Bit Address. To enter a different address, click on the button and input the desired address.



◆ Function

The Bit Switch functions are as follows.

- Bit Set:** When the Bit Switch is pressed, the PLC's designated Bit Address is turned ON. This state continues (i.e. remains ON) even after the switch is released.
- Bit Reset:** When the Bit Switch is pressed, the PLC's designated Bit Address is turned OFF. This state continues (i.e. remains OFF) even after the switch is released.
- Momentary:** Only while the Bit Switch is pressed and held is the specified PLC Bit Address turned ON. Thus, when the switch is released, the specified Bit Address is turned OFF.
- Bit Invert:** Every time the Bit Switch is pressed, the PLC's designated Bit Address state is changed (from ON to OFF, or from OFF to ON).

■ Bit Switch [Shape/Color] Attributes

Here, the Switch's border color (Frame), ON/OFF state colors (On Color, Off Color), and pattern can be selected.

▼ Reference 2.1 Parts ■ Selecting Colors

The color and pattern settings available will differ depending on the switch's settings.

■ Bit Switch [Label] Attributes

Here, the text of the Label to be displayed on the Switch button is entered.

▼ Reference 2.1 Parts ■ Creating Labels

■ Bit Switch [Extend] Attributes

Set up the Interlock and Buzzer functions.

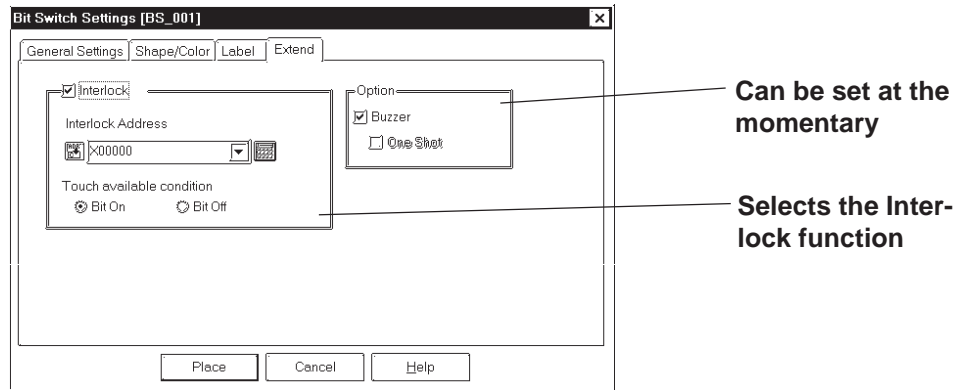

◆ Interlock

Only when a bit designated via Interlock Address is in a state that has been selected via [Touch available condition], the switch becomes effective. Whether the switch is effective in ON state or in OFF state is selectable here.



Note:

The “Bit Off” feature is available only with the GP-377, GP77R and GP2000 series.

Touch Available Condition	Interlock Address Status	Touch Available/ Not Available
Bit ON	ON	Touch Available
	OFF	Touch Not Available
Bit OFF	ON	Touch Not Available
	OFF	Touch Available

◆ Buzzer

Select ON or OFF for the buzzer sound.

When buzzer setting is enabled, the buzzer sounds while the touch switch is being pressed.

◆ One-Shot

Enable/disable the "One-Shot" feature.

This setting can be enabled only when "Momentary" mode is selected in the "Function" area in the "General Settings" tab. When the "One-Shot" feature is enabled, the buzzer will sound briefly only at the moment the touch switch is pressed.

Reference Tag Reference Manual, 2.23.4 One-Shot Buzzer for T-tag momentary



Note:

The "One-Shot" feature is available only with the GP-377, GP77R and GP2000 series.

■ **Placing a Bit Switch**

An example of how to place a Reverse Switch is shown below.

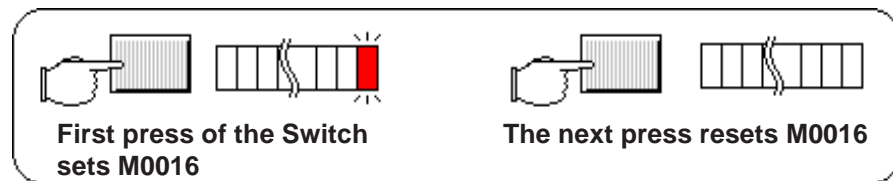

PROCEDURE	REMARKS
-----------	---------

(1) Select the [Parts] menu - [Bit Switch] command, or click on the icon.

(2) In the [General Settings] screen, input the Bit Address and select the Bit's Function.

(3) Select a Part Shape from the Browser. Specify settings for Shape/Color, Label and Extension Settings if necessary.



(4) After all of a Part's attributes have been entered or selected, click on the button.

The Switch's outline will appear on the Base screen, next to your cursor.

When the Change State function selected, after entering the Bit Address, if you attempt to perform another area's operation before entering the Monitor Bit Address, the dialog box shown below will appear. Click on the button to input the same address as used for the Bit Address. To enter a different address, click on the button and input the desired address.

Reference 2.1 Parts ■ *Selecting a Part Shape*

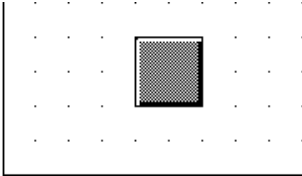
Image Parts can be used with the GP2000 series.

PROCEDURE	REMARKS
<p>(5) Click on the point where the Switch's top left corner is to be placed.</p> <p>If desired, use the Switch's handles to alter its size.</p> 	<p>To cancel the placement, click on the  icon.</p> <p>To change the Part's size, refer to Reference 2.4.3 <i>Scaling Up/Down</i>.</p> <p>Double-clicking on any Part placed on the screen automatically calls up that Part's Attribute Setting dialog box.</p> <p>Reference 2.4.14 <i>Changing Attributes</i></p>

2.1.2 Word Switches

Here, a touch panel switch for setting data to a specified Word Address can be created.

■ Word Switch [General Settings] Attributes

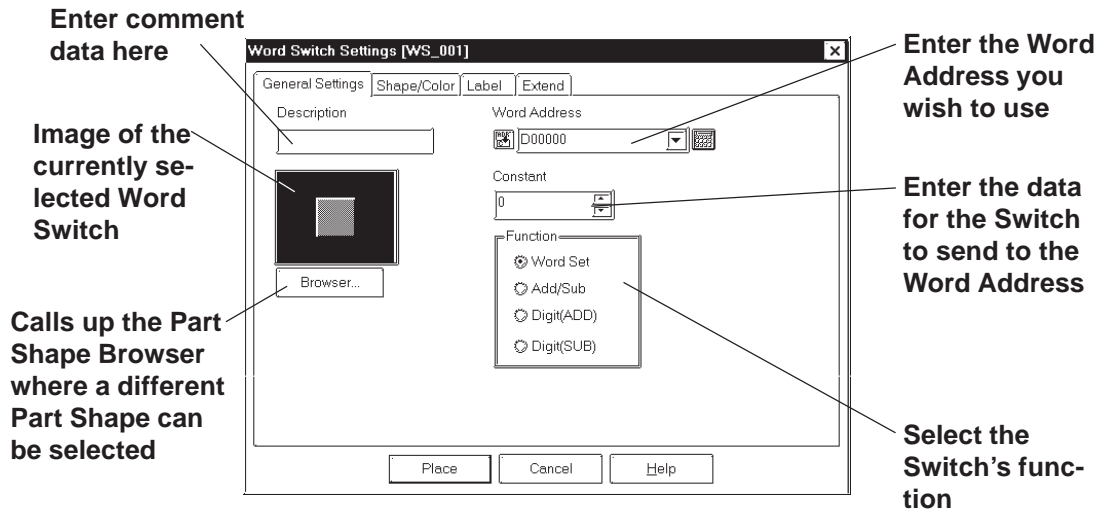

◆ Word Address

Here, the desired Word Address is entered.

◆ Constant

Here, number registered to the Word Address is input. The data format is Decimal (Base 10), and the input range is from -32768 to 32767.

◆ Function

The Word Switch's functions are as follows:

- Word Set:** When the Word Switch is pressed, constant data is written to the PLC's designated Word Address. Fixed or default values will be written to the timer, counter, etc.
- Add/Sub:** Every time the Word Switch is pressed, the Data value is added to the data currently in the PLC's designated Word Address, and the result is then written to the PLC's address. If a Data value is positive, the function will increment, and if it is negative, it will decrement.
- Digit (ADD):** Every time the Word Switch is pressed, the designated decimal place's data will be added by the Constant's value. The result will not be carried up to the next digit, so "9" simply rolls around to "0". Select the data format from Bin and BCD.
- Digit (SUB):** Every time the Word Switch is pressed, the designated decimal place's data will be subtracted by the Constant's value. The result will not be carried down to the lower digit, so "9" simply rolls around "0". Select the data format from Bin and BCD.

■ **Word Switch [Shape/Color] Attributes**

Here, a Word Switch’s color, and pattern can be selected.

▼ **Reference** ▲ 2.1 Parts ■ *Selecting Colors*

The color and pattern settings available will differ depending on the Switch’s settings, such as its shape and Change State condition.

■ **Word Switch [Label] Attributes**

Here, the text characters shown (engraved) on the Switch button face are input.

▼ **Reference** ▲ 2.1 Parts ■ *Creating Labels*

■ **Word Switch [Extend] Attributes**

Here, the interlock and the buzzer can be set as shown below.

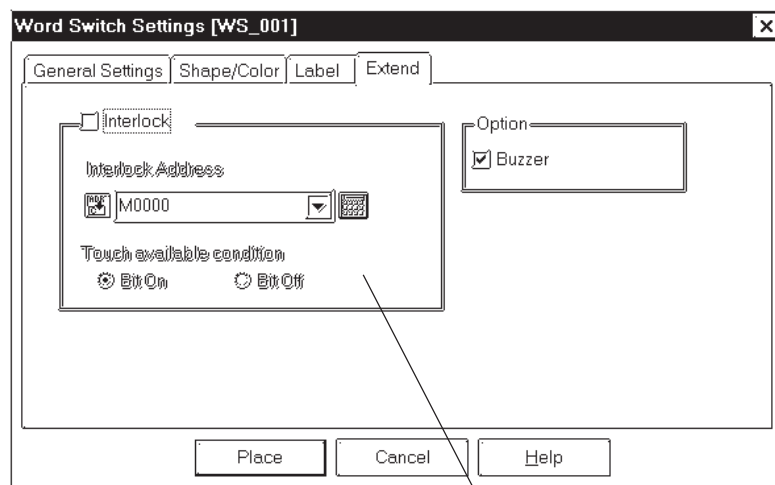

Select the Interlock function state

◆ **Interlock**

Only when a bit designated via Interlock Address is in a state that has been selected via [Touch available condition], the switch becomes effective. Whether the switch is effective in ON state or in OFF state is selectable here.



Note: The “Bit Off” feature is available only with the GP-377, GP77R and GP2000 series.

Touch Available Condition	Interlock Address Status	Touch Available/ Not Available
Bit ON	ON	Touch Available
	OFF	Touch Not Available
Bit OFF	ON	Touch Not Available
	OFF	Touch Available

◆ **Buzzer**

Sets the buzzer to ON/OFF

■ **Placing a Word Switch**

An example of how to place a Data Set Switch is shown below.

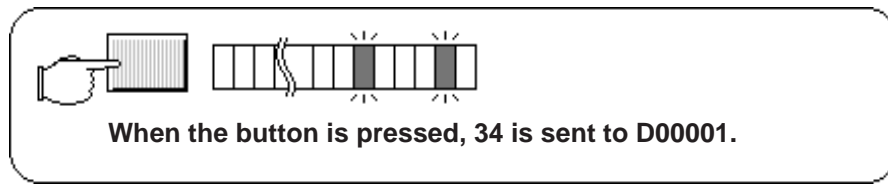

PROCEDURE	REMARKS
-----------	---------

(1) Select the [Parts] menu - [Word Switch] command, or click on the icon.

(2) In the [General Settings] area, input the Word Address and Constant data, and select a function.

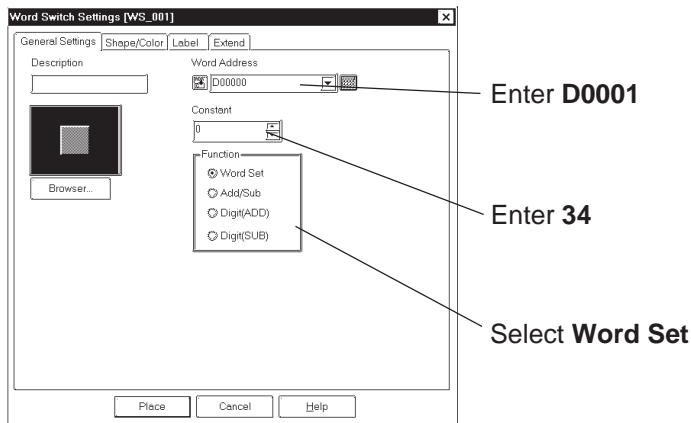

(3) Select a Part Shape from the Browser. Specify settings for Shape/Color, Label and Extension Settings if necessary.

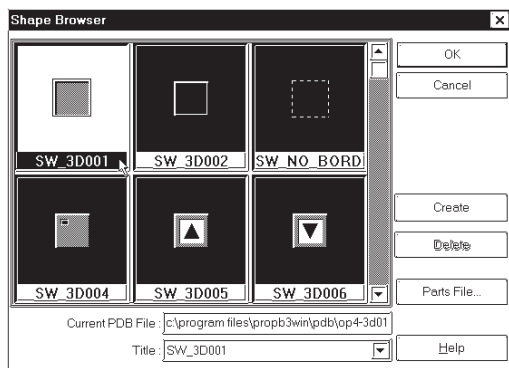



(4) After all of the Part's attributes have been entered or selected, click on the button.

The Switch's outline will appear on the Base screen, next to your cursor.

Reference 2.1 Parts ■ *Selecting a Part Shape*

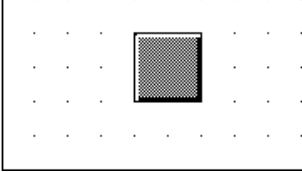
Image Parts can be used with the GP2000 series.

PROCEDURE	REMARKS
<p>(5) Click on the point where the Switch's top left corner is to be placed.</p> <p>If desired, use the Switch's handles to alter its size.</p> 	<p>To cancel the placement, click on the  icon.</p> <p>Reference To change the Part's size, refer to 2.4.3 Scaling Up/Down</p> <p>Double-clicking on any Part placed on the screen automatically calls up that Part's attribute settings.</p> <p>Reference 2.4.14 Changing Attributes</p>

2.1.3 Function Switches

Here, a touch panel with special functions can be created.

■ Function Switch [General Settings] Attributes

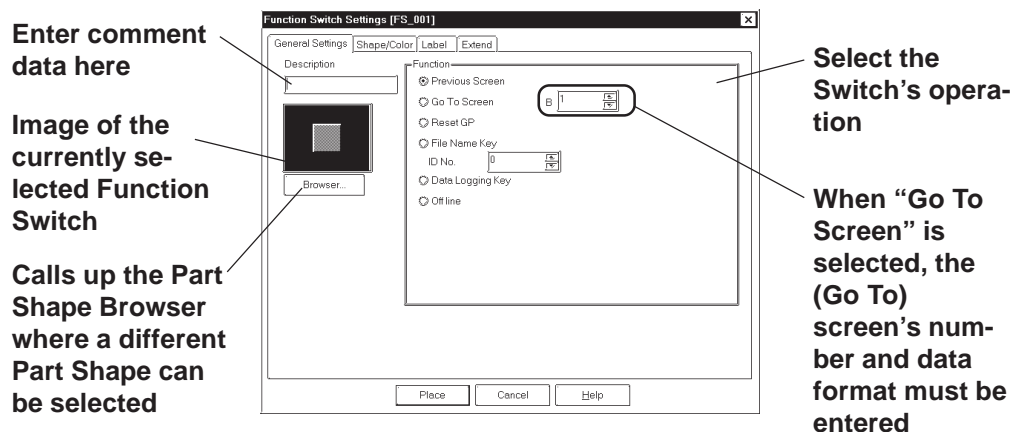

◆ Function (Switch Operation)

The Function Switch's attributes are as follows:

- Previous Screen:** When the Switch is pressed, the currently displayed screen on the GP will change to the previously displayed one.
- Go To Screen:** When the Switch is pressed, the currently displayed screen on the GP will change to the specified screen. Input the screen number to be changed (jumped) to. The Data Format can be either Bin or BCD.



Note: If a screen number is specified in the BCD data format to place the corresponding screen, it is still displayed in the BIN data format when the screen is closed and then opened.

- Reset GP:** When the Switch is pressed, the GP will be reset to the save status as when the GP's power was turned ON.
- File Name Key:** This is a function switch corresponding to the File Name Display and is the same as the one that is automatically placed together with the File Name Display. Designate the same ID number as the one of the File Name Display and select a operation mode.

Reference 2.1.16 File Name Display

Data Logging Key:

This is a function switch corresponding to the Data Logging Display and is the same as the one that is automatically placed together with the Data Logging Display. Designate the scroll direction and the number of lines being rolled up or down.

▼ **Reference** ▲ *2.1.17 Data Logging Display*

OFFLINE:

When this switch is pressed, the GP enters the OFFLINE mode.

■ Function Switch [Shape/Color] Attributes

The Switch's color, and pattern are selected here.

▼ **Reference** ▲ *2.1 Parts ■ Selecting Colors*

The color and pattern settings available will differ depending on the switch shape.

■ Function Switch [Label] Attributes

Here, the characters shown (drawn) on the Switch button face are entered.

▼ **Reference** ▲ *2.1 Parts ■ Creating Labels*

■ Function Switch [Extend] Attributes

Here, the interlock and the buzzer are set.

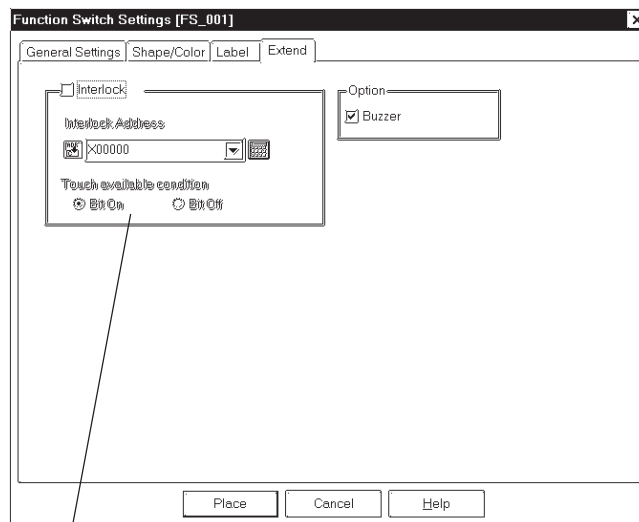

Select the Interlock function state

◆ **Interlock**

Only when a bit designated via Interlock Address is in a state that has been selected via [Touch available condition], the switch becomes effective. Whether the switch is effective in ON state or in OFF state is selectable here.



Note: The “Bit Off” is available only with the GP-377, GP77R and GP2000 series.

Touch Available Condition	Interlock Address Status	Touch Available/Not Available
Bit ON	ON	Touch Available
	OFF	Touch Not Available
Bit OFF	ON	Touch Not Available
	OFF	Touch Available

◆ **Buzzer**



Sets the buzzer to ON/OFF.

■ **Placing a Function Switch**

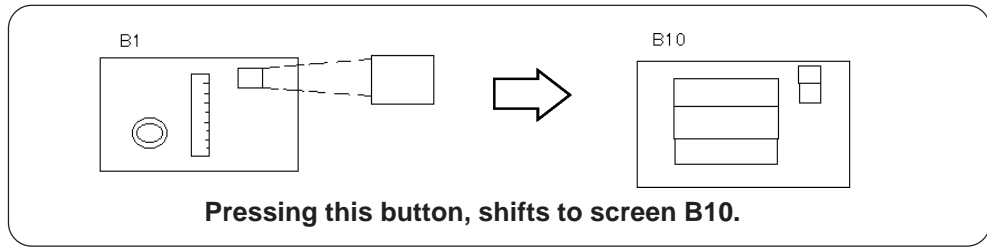
The Screen Switching (Function) Switch's placement procedure is shown below.

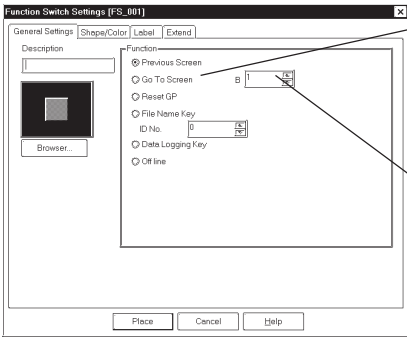
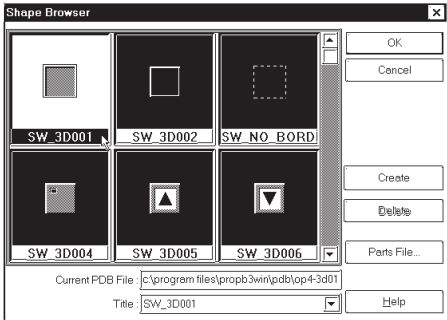

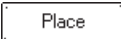
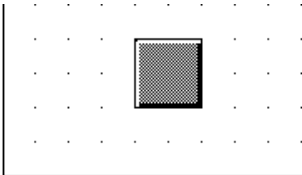
PROCEDURE	REMARKS
<p>(1) Select the [Parts] menu - [Function Switch] command, or click on the  icon.</p> <p>(2) Designate the [Function] on the [General Settings] tab.</p>  <p>(3) Select a Part Shape from the Browser. Specify settings for Shape/Color, Label and Extension Settings if necessary.</p> 	<p>Reference 2.1 Part ■ <i>Selecting a Part Shape</i></p> <p>Image Parts can be used with the GP2000 series.</p>

PROCEDURE	REMARKS
<p>(4)After all of Part's attributes have been entered or selected, click on the  button.</p> <p>The Switch's outline will appear in the Base screen, next to the cursor.</p> <p>(5)Click on the point where the Switch's top left corner is to be placed.</p> <p>If necessary, use the Switch's handles to alter its size.</p> 	<p>To cancel the placement, click on the  icon.</p> <p>To change the Part's size, refer to: Reference 2.4.3 <i>Scaling Up/Down</i></p> <p>Double-clicking on any Part placed on the screen calls up that Part's Attribute Setting dialog box. Reference 2.4.14 <i>Changing Attributes</i></p>

2.1.4 Toggle Switches

Here a toggle type touch panel switch, used to turn a specified Bit ON or OFF is created.



Note: A Toggle Switch will not be displayed on the GP when transferred, if the GP has not yet been connected to the PLC.

■ Toggle Switch [General Settings] Attributes

Enter comment data here

Changes the state of the dialog box's switch display to either ON or OFF

Displays the currently selected Part

Calls up the Part Shape Browser where a different Part Shape can be selected

Enter the Bit Address to be operated via the Switch

Enter the desired Monitor Bit Address here

◆ Operation Bit Address

The number of the Bit Address to be operated via the Switch is entered here.

◆ Monitor Bit Address

Here, the Monitor Bit Address used to change the Switch's display is entered. The Switch's ON/OFF state can be made to change according to changes in the Monitor Bit Address data. The same address as the Bit Address's can be used here.

After entering the Bit Address, if you attempt to perform another area's operation before entering the Monitor Bit Address's data, the dialog box shown below will appear. Clicking on the button automatically enters the Bit Address data. To input an address different from the Bit Address, click on the button and input the desired Monitor Bit Address.

■ **Toggle Switch [Shape/Color] Attributes**

The Switch's frame colors (Frame) for the ON and OFF states can be selected.

▼ **Reference** 2.1 Parts ■ *Setting Colors*

The color and pattern settings available will differ depending on each switch's settings, such as its shape and state change conditions.

■ **Toggle Switch [Label] Attributes**

Here, the text characters shown (Raised) on the Switch button face are entered.

▼ **Reference** 2.1 Parts ■ *Setting Labels*

■ **Toggle Switch [Extend] Attributes**

Here, the interlock and the buzzer are set.

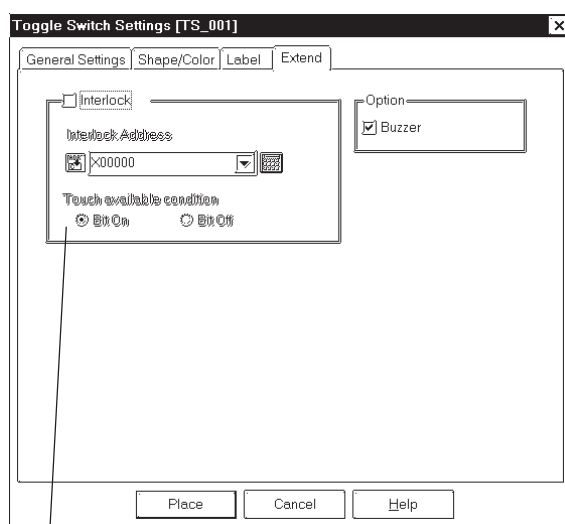

Select the Interlock function state

◆ **Interlock Address**

Only when a bit designated via Interlock Address is in a state that has been selected via [Touch available condition], the switch becomes effective. Whether the switch is effective in ON state or in OFF state is selectable here.



Note: This “Bit Off” feature is available only with the GP-377, GP77R and GP2000 series.

Touch Available Condition	Interlock Address Status	Touch Available/Not Available
Bit ON	ON	Touch Available
	OFF	Touch Not Available
Bit OFF	ON	Touch Available
	OFF	Touch Not Available



◆ **Buzzer**

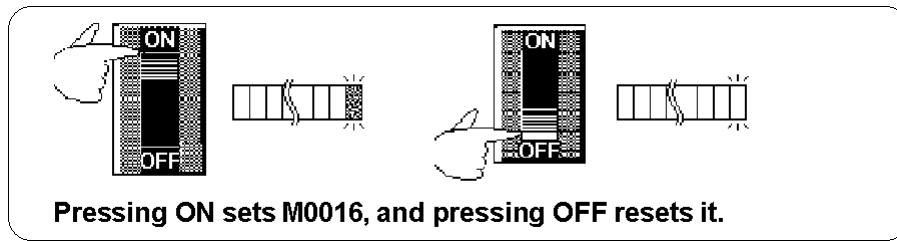

Sets the buzzer to ON/OFF.

■ **Placing a Toggle Switch**

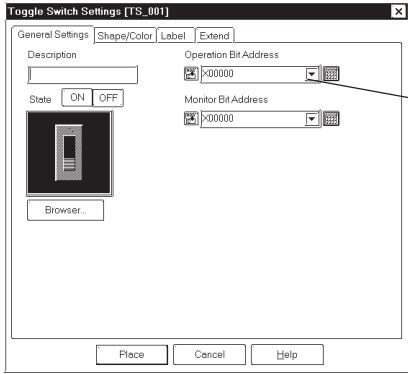
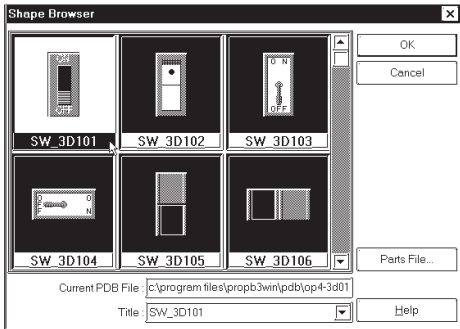
The Toggle Switch placement procedure is shown below.

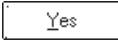
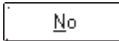

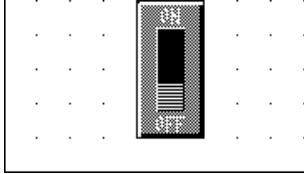
PROCEDURE	REMARKS
<p>(1) Select the [Parts] menu - [Toggle Switch] command, or click on the  icon.</p> <p>(2) In the [General Settings] area, input the Operation Bit Address.</p>  <p>(3) Select a Part Shape from the Browser. Specify settings for Shape/Color, Label and Extension Settings if necessary.</p>  <p>(4) After all of a Part's attributes have been entered or selected, click on the  button.</p> <p>The Switch's outline will appear in the Base screen, next to your cursor.</p>	<p>After entering the Operation Bit Address, if you attempt to perform another area's operation before entering the Monitor Bit Address data, the dialog box shown below will appear.</p>  <p>Clicking on the  button automatically inputs the Operation Bit Address into the Monitor Bit Address area. To input an address different from the Bit Address, click on the  button.</p> <p>Reference 2.1 Parts ■ <i>Selecting a Part Shape</i></p>

PROCEDURE	REMARKS
<p>(5) Click on the point where the Switch's top left corner is to be placed.</p> <p>If desired, use the Switch's handles to alter its size.</p> 	<p>To cancel the placement, click on the  icon.</p> <p>To change a Part's size, refer to Reference 2.4.3 <i>Scaling Up/Down</i></p> <p>Double-clicking on any Part placed on the screen automatically calls up that Part's attribute settings.</p> <p>Reference 2.4.14 <i>Changing Attributes</i></p>

2.1.5 Lamps

Here a lamp is created, which turns ON or OFF according to the PLC's Monitor Bit Address state.



- **Lamps will not display on the GP unless the GP has been connected to the PLC.**
- **When placing a Lamp, DO NOT overlap it with other objects. If you do so, it may not be displayed correctly.**

■ Lamp [General Setting] Attributes

Enter comment data here

Displays the currently selected Part

Calls up the Part Shape Browser. Part Shapes can be selected directly from here

Enter the desired Bit Address here

Changes the state of the dialog box's switch display to either ON or OFF

◆ Bit Address

The Bit Address to be monitored is entered here.

■ Lamp [Shape/Color] Attributes

Here, border colors for both ON and OFF states, and Lamp's colors and tiling pattern in each state can be selected.

▼ Reference ▲ 2.1 Parts ■ Selecting Colors

The color and pattern settings available will differ depending on each lamp shape.

■ Lamp [Label] Attributes



Here, the text characters shown on a Lamp button's face are entered.

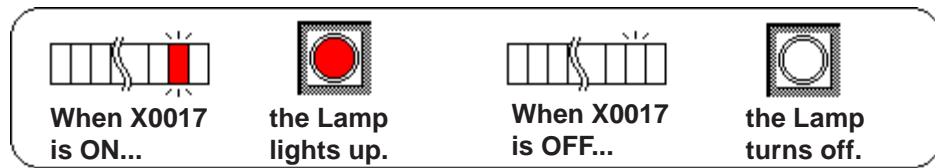

▼ Reference ▲ 2.1 Parts ■ Creating Labels

■ **Placing a Lamp**

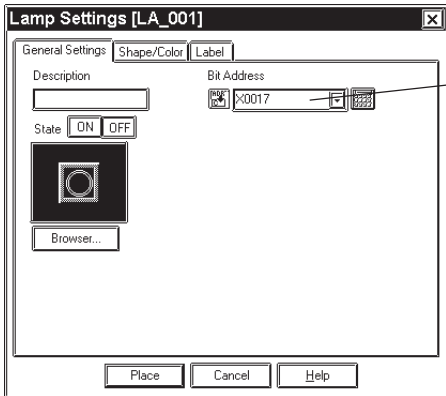
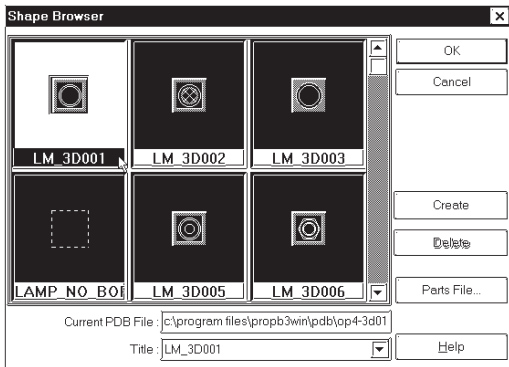
The procedures for creating and placing a Lamp are shown below.

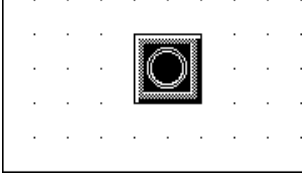

PROCEDURE	REMARKS
<p>(1) Select the [Parts] menu - [Lamp] command, or click on the  icon.</p> <p>(2) In the [General Settings] area, enter a Bit Address.</p>  <p>(3) Select a Part Shape from the Browser. Select Colors and input a Label, if desired.</p>  <p>(4) Switch the state of the lamp with the On/Off buttons, and then select Colors and input a Label.</p> <p>(5) After all of the Lamp's attributes have been entered or selected, click on the  button.</p> <p>The Lamp's outline will appear in the Base screen, next to your cursor.</p>	<p>Reference 2.1 Parts ■ <i>Selecting a Part Shape</i></p> <p>Image Parts can be used with the GP2000 series.</p> <p>With the Blink check box checked , and if the Bit is turned ON, the Lamp will blink. Lamp blinking can also be seen via the pull down menu [View]'s [Preview] command.</p> <p>Reference 2.8.3 <i>Preview Screen</i></p>

PROCEDURE	REMARKS
<p>(6) Click on the point where the Lamp's top left corner is to be placed.</p> <p>If necessary, use the Lamp's handles to alter its size.</p> 	<p>To cancel the placement, click on the  icon.</p> <p>To change the Part's size, refer to Reference 2.4.3 <i>Scaling Up/Down</i></p> <p>Double-clicking on any Part placed on the screen automatically calls up that Part's attribute settings.</p> <p>Reference 2.4.14 <i>Changing Attributes</i></p>

2.1.6 4-State Lamp

Here, a 4-State Lamp, which changes its state according to whether the PLC's two Monitor Bits are ON or OFF, are created.



- **Even when a 4-State Lamp data is transferred to the GP, if the GP and PLC have not communicated, the 4-State Lamp will not be displayed on the GP.**
- **When placing a 4-State Lamp, DO NOT overlap it with other objects. If you do so, it may not be displayed correctly.**

■ Features of 4-State Lamp

Enter comment data here, if necessary.

Changes the state of the Lamp currently displayed on the dialog box to either ON or OFF.

Displays the currently selected Part's image.

Calls up the Part Shape Browser. A Part Shape can be selected directly from here.

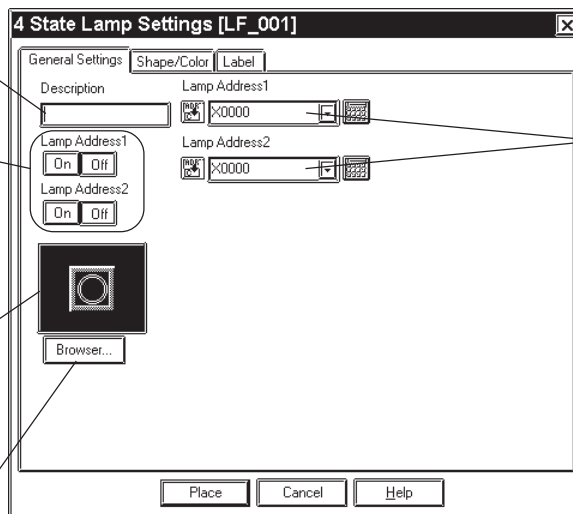

Enter a desired Bit Address to be monitored.

◆ Lamp Address

Enter the two Bit Addresses (Lamp Addresses 1 and 2) to be monitored.

◆ Lamp Address On Off

Changes the Lamp state by changing the combination of the two Bit's ON/OFF state.



When the two Bits that have been assigned to the Lamp Addresses are changed simultaneously, the Lamp state change is recognized as follows according to the Bit read timing, which makes the Lamp display flicker.

e.g.) **When Lamp Addresses 1 and 2 are changed from OFF to ON simultaneously:**

Lamp Address 1	0 → 0 → 1
Lamp Address 2	0 → 1 → 1

Or

Lamp Address 1	0 → 1 → 1
Lamp Address 2	0 → 0 → 1

■ Features of 4-State Lamp [Shape/Color]

Here, a 4-State Lamp’s border colors for both ON and OFF states and Lamp’s colors and tiling pattern in each state can be selected.

▼ **Reference** ▲ 2.1 Parts ■ *Selecting Colors*

The color and pattern settings available (effective) will differ depending on each Lamp shape.

■ Features of 4-State Lamp [Label]

Here, the text characters shown on a Lamp button’s face are entered.

▼ **Reference** ▲ 2.1 Parts ■ *Creating Labels*

■ Positioning a Lamp

The procedure for creating and placing a 4-State Lamp are shown below.

The Lamp state will be switched according to the Lamp Addresses X0017’s and X0018’s ON/OFF states.



When X0017 is OFF and X0018 is OFF



When X0017 is ON and X0018 is OFF





When X0017 is ON and X0018 is ON

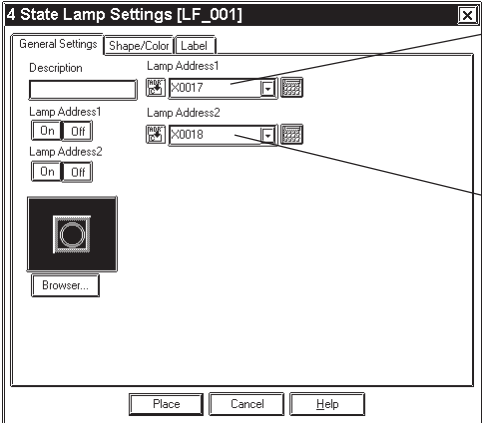

When X0017 is OFF and X0018 is ON

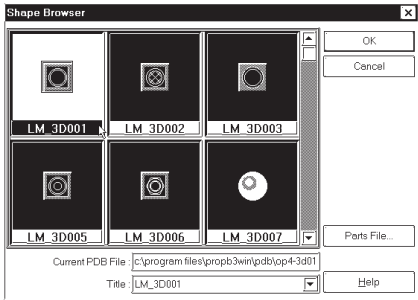
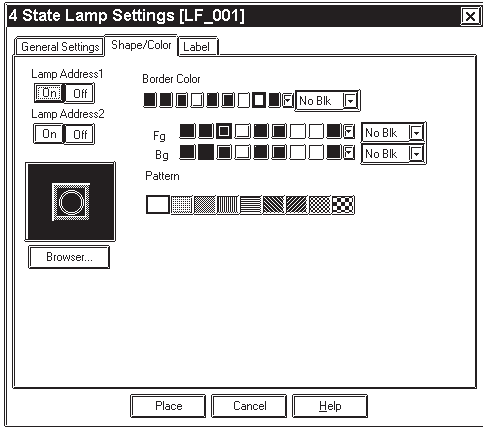
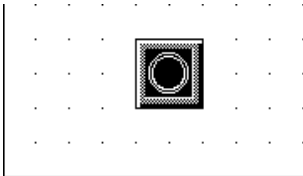
PROCEDURE	REMARKS
<p>(1) Select the [Parts] menu - [4-State Lamp] command, or click on the  icon.</p> <p>(2) Enter Lamp Addresses 1 and 2 in the [General Settings] tab.</p> 	

PROCEDURE	REMARKS
<p>(3) Select a Part Shape from the Browser. Select Colors and set up a Label, if desired.</p>  <p>(4) User either <input type="checkbox"/> On <input type="checkbox"/> or <input type="checkbox"/> Off <input type="checkbox"/> button to change the Lamp Address states and select Colors and Pattern for each state. Set up a Label for each state, if desired.</p>  <p>(5) After all of a Part's attributes have been entered or selected, click on the <input type="button" value="Place"/> button. The 4-State Lamp's outline will appear on the Base screen, next to your cursor.</p> <p>(6) Click on the point where the 4-State Lamp's top corner is to be placed. Use the 4-State Lamp's handles to alter its size, if necessary.</p> 	<p>Reference 2.1 Parts ■ <i>Selecting a Part Shape</i></p> <p>To cancel the placement, click on the  icon.</p> <p>Reference To change the Part's size, refer to 2.4.3 <i>Scaling Up/Down</i>.</p> <p>Double-clicking on any Part placed on the screen automatically calls up that Part's attribute settings.</p> <p>Reference 2.4.14 <i>Changing Attributes</i></p>

2.1.7 Bar Graphs

Here the setup (creation and placement) of a bar graph is explained. Bar Graphs are used to display PLC Word Address numeric data in absolute or relative values. This graph's display will change according to Word Address data changes.

■ Bar Graph [General Settings] Attributes

<When displaying Word Address numeric data in absolute values>

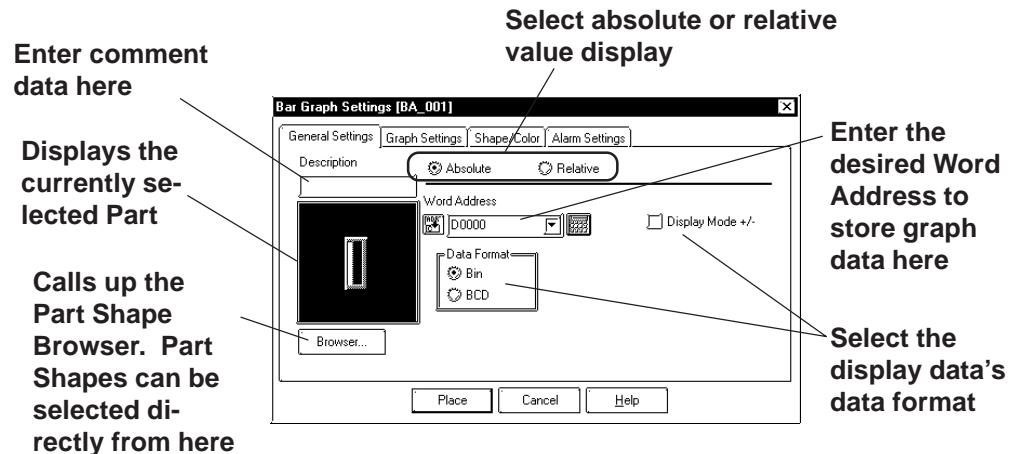

◆ Absolute

Data stored in the Word Address is displayed in absolute values from 0 to 100 (with Display Mode +/- selected, -100 to 100).

◆ Word Address

Here, enter the Word Address used for storing the Bar Graph's data.

◆ Data Format

The display data's format can be either Bin or BCD.

When Bin is selected, negative numeric data can also be displayed. In that case, check the Display Mode +/- check box.

<When displaying Word Address numeric data in relative values>

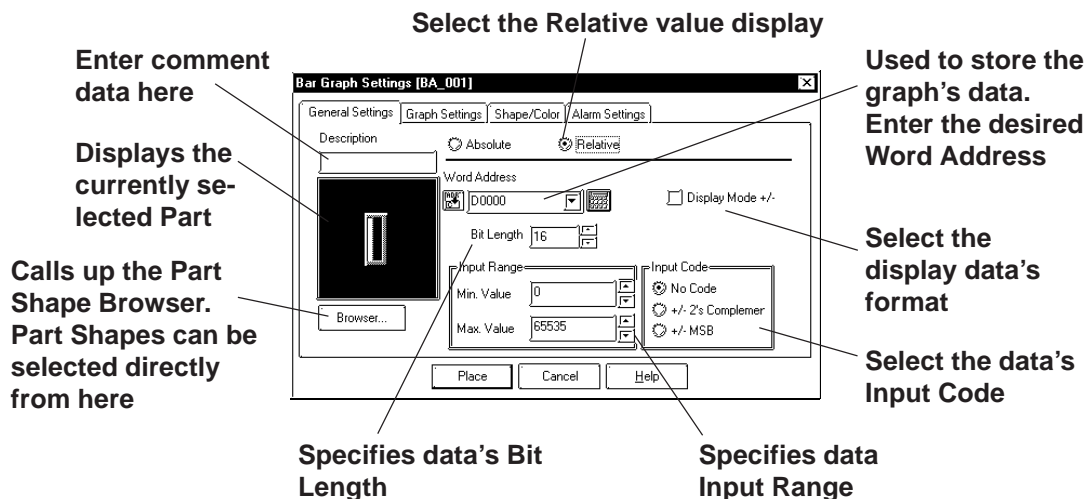
◆ **Relative**

According to the Input Range designated for the Word Address' data, the data is converted and displayed as relative values.

◆ **Word Address**

Here, enter the Word Address used for storing the Bar Graph's data.

◆ **Display Mode +/-**

When this check box is checked, negative numeric data can also be displayed.

◆ **Bit Length**

Specifies the Bit Length of data stored in the Word Address.

◆ **Input Range**

Specifies the data's Input Range.

◆ **Input Code**

When No Code is selected, only positive data can be entered. To enter negative number data, select +/- 2's Complement or +/- MSB.

■ Bar Graph [Graph Settings] Attributes

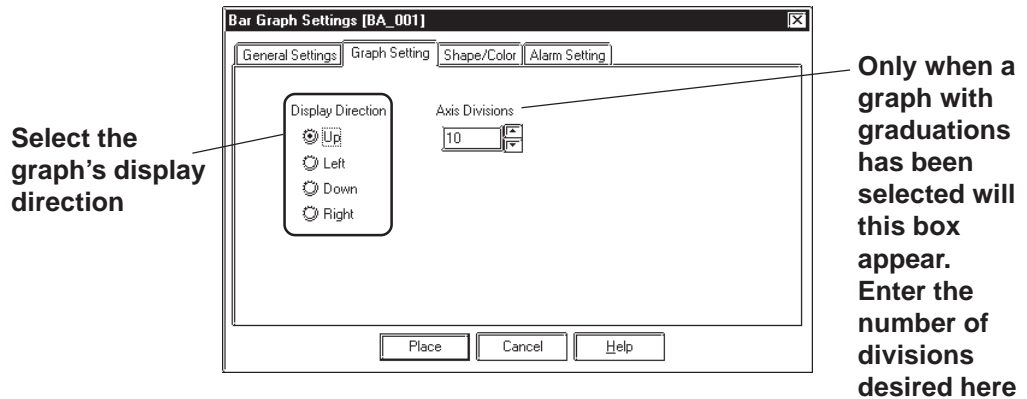

◆ Direction

The graph's display direction can be specified as either Up, Left, Down, or Right.



If [Display Direction] is changed for a 3D part, its shade is rotated along with that part. To let the shade displayed properly, click on the button, and select the part again from [Shape Browser].

◆ Axis Divisions

For a graph which has graduations, the number of divisions are entered here. If the number of the divisions is specified to 10, then 11 division lines are used. When graduations are not necessary, specify the number of the divisions as 0.



Whether the graduations are necessary or not will differ depending on the Part's shape.

■ Bar Graph [Shape/Color] Attributes

The graph's border color, division color (Axis Color), display data color (Graph Color), and display data patterns are selected here.

▼ **Reference** 2.1 Parts ■ *Selecting Colors*

■ Bar Graph [Alarm Settings] Attribute

If desired, an Alarm can be setup here by toggling the Alarm check box.



▼ **Reference** 2.1 Parts ■ *Setting Alarms*

■ Placing a Bar Graph

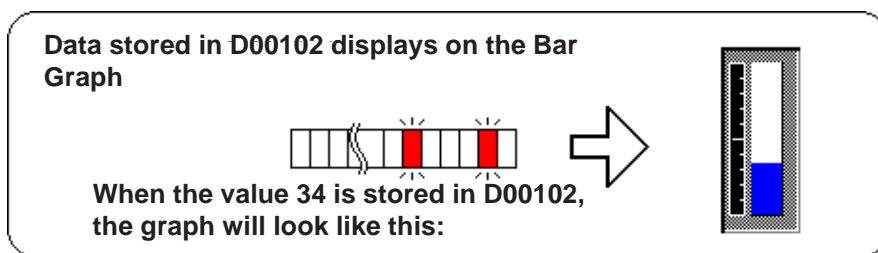
An example of the Bar Graph's creation and placement procedures are shown below.

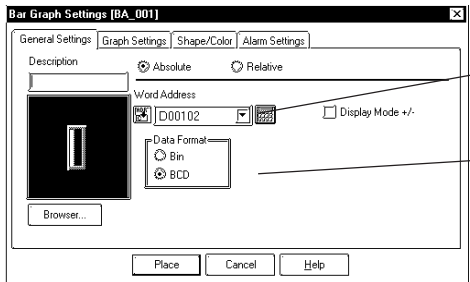
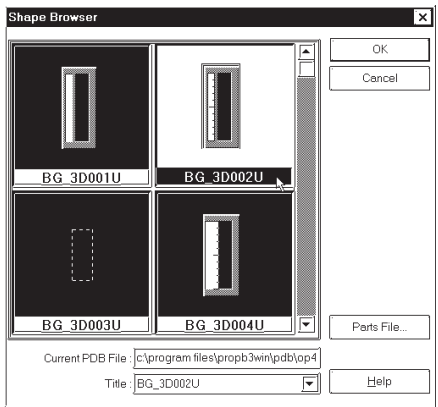
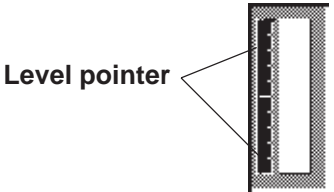

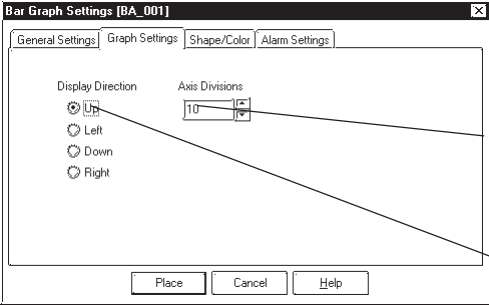
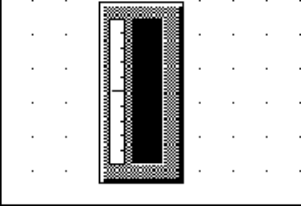
PROCEDURE	REMARKS
<p>(1) Select the [Parts] menu - [Bar Graph] command, or click on the  icon.</p> <p>(2) In the [General Settings] tab, input a Word Address and select a Data Format.</p>  <p>(3) Select a Part Shape that has graduations from the Browser.</p> <p>Here, you can enter Alarm settings and select Colors, if desired.</p> 	<p>Reference 2.1 Parts ■ <i>Selecting a Part Shape</i></p> <p>If the Bar Graph's Alarm value is specified as Variable, a pointer showing levels will be displayed. This pointer's position will move according to the specified Alarm value.</p> 

PROCEDURE	REMARKS
<p>(4) In the [Graph Settings] tab, select the graph's display direction and input the number of Axis Divisions.</p>  <p>(5) After all of the graph's attributes have been entered or selected, click on the <input type="button" value="Place"/> button.</p> <p>The Bar Graph's outline will appear on the Base screen, next to your cursor.</p> <p>(6) Click on the point where the Bar Graph's top left corner is to be placed.</p> <p>If necessary, use the Bar Graph's handles to adjust its size.</p> 	<p>The area to enter the number of the divisions will appear only for a graph type which has axis divisions.</p> <p>To cancel the placement, click on the  icon.</p> <p>To change the Part's size, refer to Reference 2.4.3 <i>Scaling Up/Down</i></p> <p>Double-clicking on any Part placed on the screen automatically calls up that Part's attribute settings.</p> <p>Reference 2.4.14 <i>Changing Attributes</i></p> <p>The Bar Graph's sizing handles are located inside the graph.</p>

2.1.8 Pie Graphs

Pie Graphs create an area where a PLC's Word Address data is displayed as absolute values. The graph's display will change to reflect changes in the designated Word Address data.

■ Pie Graph [General Settings] Attributes

<When displaying the data using absolute values>

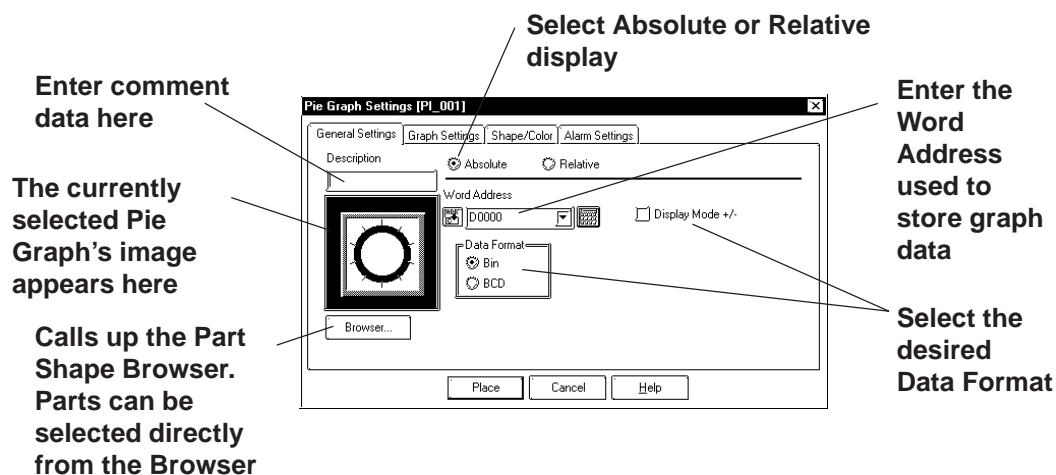

◆ Absolute

Data stored in the designated Word Address is displayed in absolute values, from 0 to 100 (with Display Mode +/- selected, -100 to 100).

◆ Word Address

Here, the Word Address' location data is entered to show where the desired data is stored.

◆ Data Format

Select either the Bin and BCD display formats.

◆ Display Mode +/-

With this check box checked and the Bin data format is selected, a negative numeric data can also be displayed.

<When displaying the data using relative values>

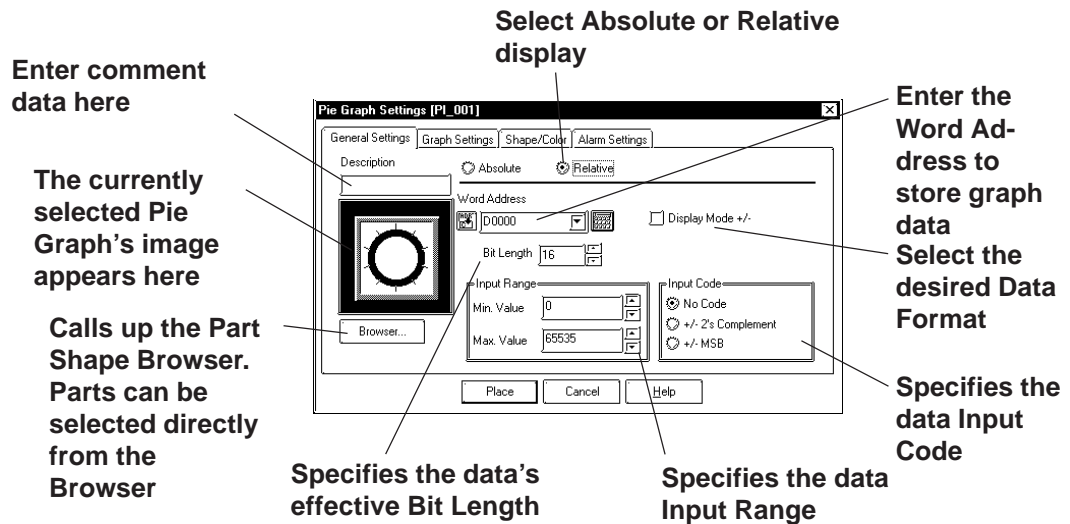
◆ **Relative**

According to the Input Range designated for the Word Address Data, the data is converted and displayed as relative values.

◆ **Word Address**

Here, enter the Word Address used to store Pie Graph data.

◆ **Display Mode +/-**

When this check box checked, negative numeric data can also be displayed.

◆ **Bit Length**

Specifies the Bit Length of all data stored in the Word Address.

◆ **Input Range**

Specifies the data's Input Range.

◆ **Input Code**

With No Code selected, only positive numeric data can be entered. To enter negative numeric data, select either +/-2's Complement or +/-MSB.

■ Pie Graph [Graph Settings] Attributes

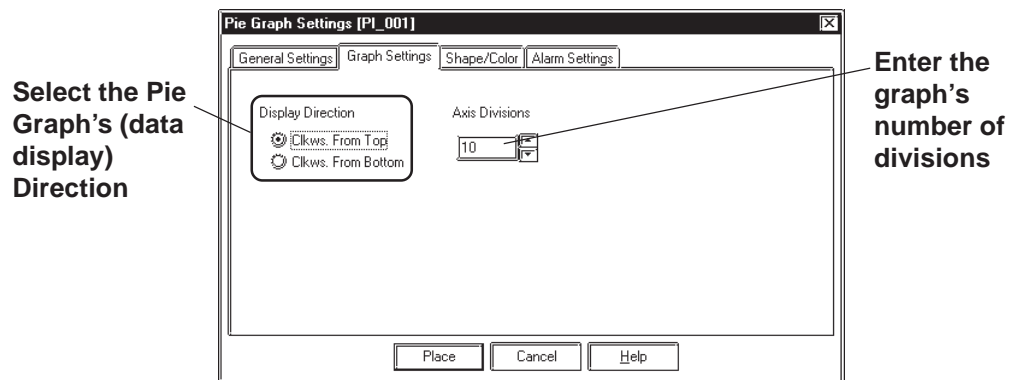

◆ Display

Here, the graph's data display start point, either Clkws. From Top or Clkws. From Bottom, can be selected.



If [Display Direction] is changed for a 3D part, its shade is rotated along with that part. To let the shade displayed properly, click on the button, and select the part again from [Shape Browser].

◆ Axis Divisions

The number of segments the Pie Graph will be divided into is entered here. If the number of Axis Divisions is specified as 10, 10 division lines will be displayed. When no divisions are necessary, simply enter 0.

■ Pie Graph [Shape/Color] Attributes

A Pie Graph's border color, division line color (Axis Color), data display color (Graph Color - Fg and Bg), and data display pattern can all be selected here.

Reference [2.1 Parts](#) ■ *Selecting Colors*

■ Pie Graph [Alarm Settings] Attributes

Clicking on the Alarm Display check box will call up the Alarm Settings.



Reference [2.1 Parts](#) ■ *Alarm Settings*

■ **Placing a Pie Graph**

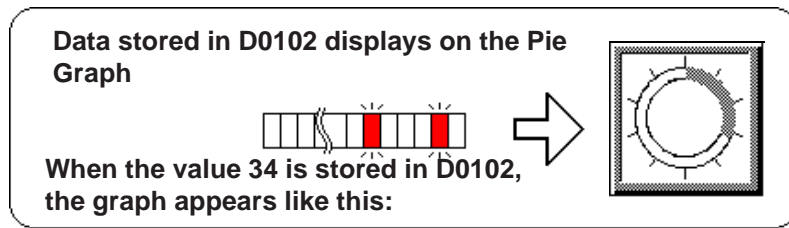
The procedure for placing a Pie Graph is shown below.

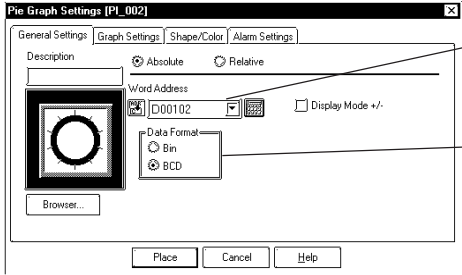
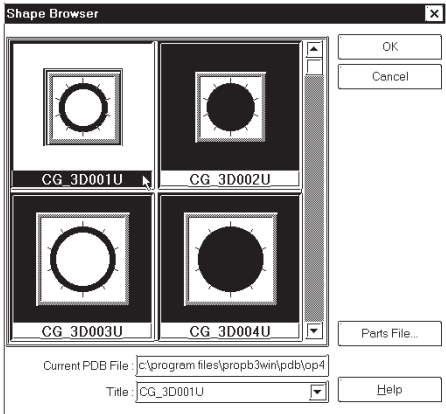

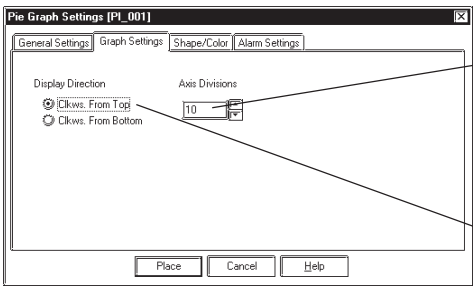
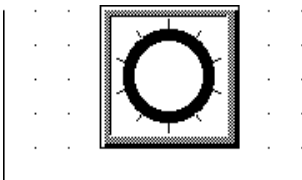
PROCEDURE	REMARKS
<p>(1) Select the [Parts] menu - [Pie Graph] command, or click on the  icon.</p> <p>(2) In the [General Settings] area, input a Word Address and select a Data Format.</p>  <p>(3) Select a Part Shape from the Browser.</p> <p>You can also use the Alarm Settings area to choose an Alarm and select Colors, if desired.</p> 	<p>Reference 2.1 Parts ■ <i>Selecting a Part Shape</i></p>

PROCEDURE	REMARKS
<p>(4) In the [Graph Settings] tab, select the display direction and input the number of Axis Divisions.</p>  <p>(5) After all of the Graph's attributes have been entered or selected, click on the  button.</p> <p>A Pie Graph's outline will appear on the Base screen, next to the cursor.</p> <p>(6) Click on the point where the Pie Graph's top left corner is to be placed.</p> <p>If desired, use the Pie Graph's handles to alter its size.</p> 	<p>The area to enter the number of the divisions will appear only for a graph type which has axis divisions.</p> <p>To cancel the placement, click on the  icon.</p> <p>To change the Part's size, refer to Reference 2.4.3 Scaling Up/Down</p> <p>Double-clicking on any Part placed on the screen automatically calls up that Part's attribute settings.</p> <p>Reference 2.4.14 Changing Attributes</p>

2.1.9 Half Pie Graphs

This graph displays a Word Address' numeric data (received from a PLC) as absolute or relative values in a Half-Pie graph. The graph's display will also change to reflect Word Address data changes.

■ Half Pie Graph [General Settings] Attributes

<When displaying the data in absolute values>

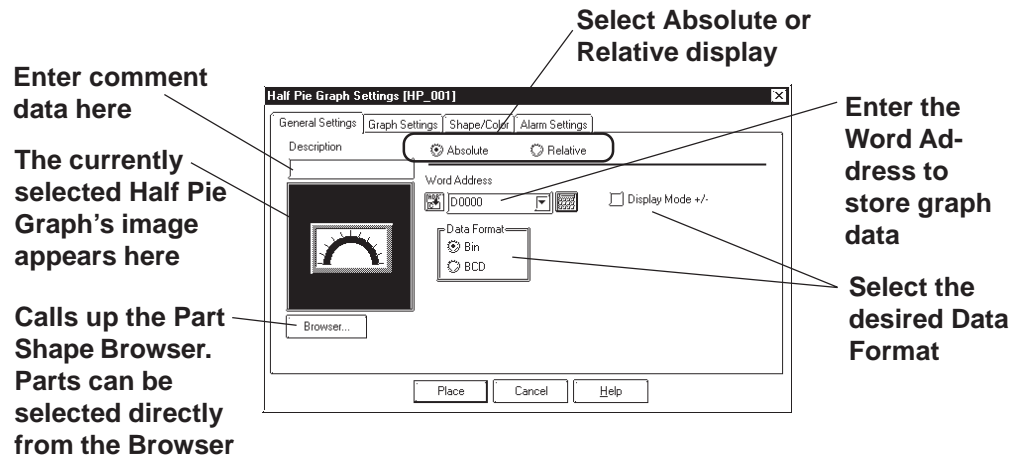

◆ Absolute

Data stored in the designated Word Address is displayed as absolute values, from 0 to 100 (with Display Mode +/- selected, -100 to 100).

◆ Word Address

Enter the Word Address where the data will be stored.

◆ Data Format

Select the display data format from Bin and BCD.

◆ Display Mode +/-

When this check box is checked and Bin data format is selected, negative numeric data can be displayed.

<When displaying the data in relative values>

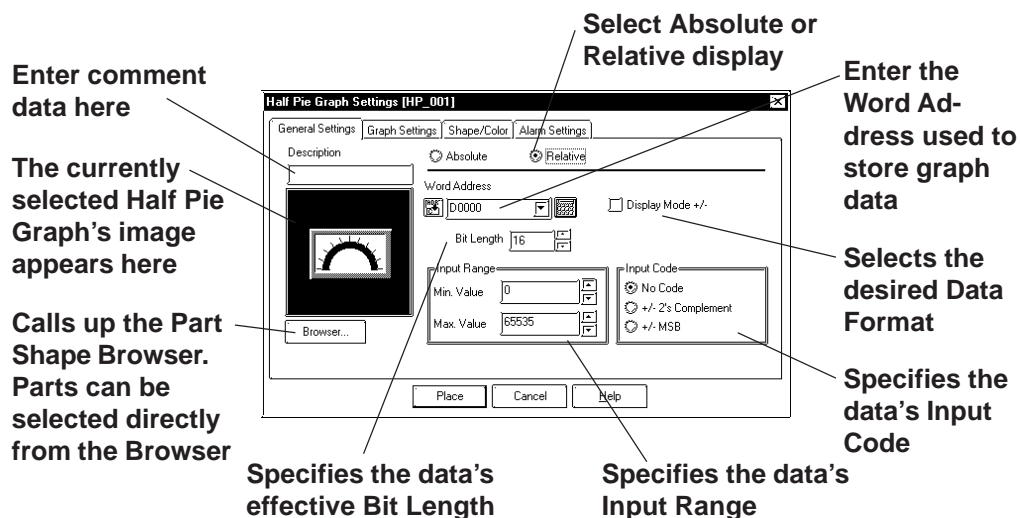
◆ **Relative**

According to the Input Range designated for the Word Address Data the data is converted and displayed as relative values.

◆ **Word Address**

Here, enter the Word Address used to store Half Pie Graph data.

◆ **Display Mode +/-**

When this check box checked, negative number data can be displayed.

◆ **Bit Length**

Specifies the Bit Length of all data stored in the Word Address.

◆ **Input Range**

Specifies the data's Input Range.

◆ **Input Code**

With No Code selected, only positive numeric data can be entered. To enter negative numeric data, select either +/-2's Complement or +/-MSB.

■ Half Pie Graph [Graph Settings] Attributes

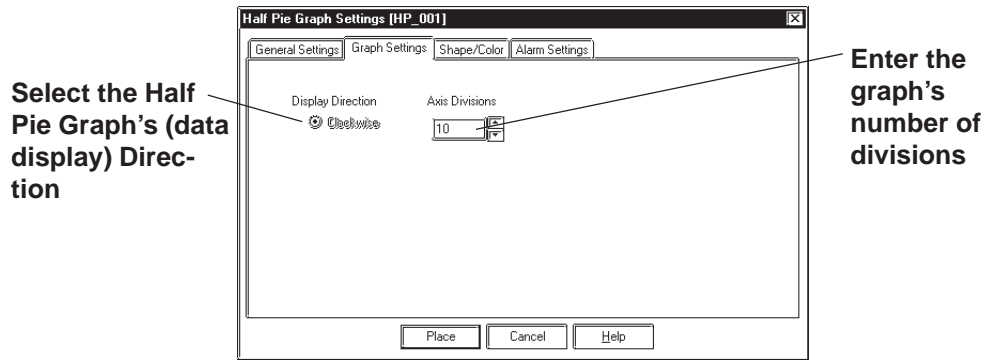

◆ Display Direction

Here, the Half Pie graph's display direction is fixed to clockwise.

◆ Axis Divisions

The data entered here determines how many pieces a Half Pie Graph is divided into. If the number of Axis Divisions is specified as 10, 11 division lines are displayed. When no divisions are necessary, specify the number of divisions as 0.

■ Half Pie Graph [Shape/Color] Attributes

Here, a Half Pie graph's border color, division color (Axis Color), display data color (Graph Color - Fg & Bg), and display data pattern are all selected.

▼ **Reference** ▲ 2.1 Parts ■ *Selecting Colors*

■ Half Pie Graph [Alarm Settings] Attributes

If desired, Alarm settings can be set here.



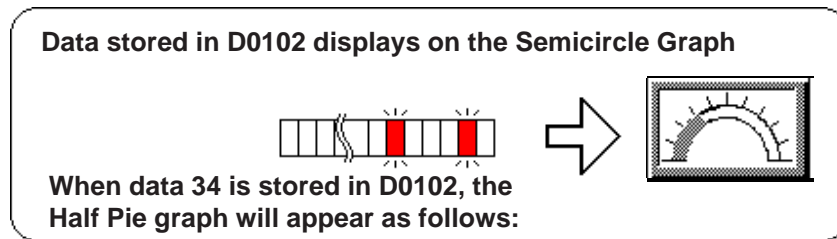

▼ **Reference** ▲ 2.1 Parts ■ *Alarm Settings*

■ **Placing a Half Pie Graph**

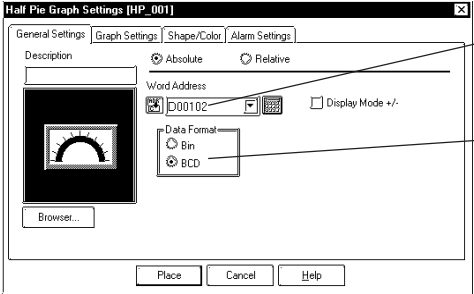
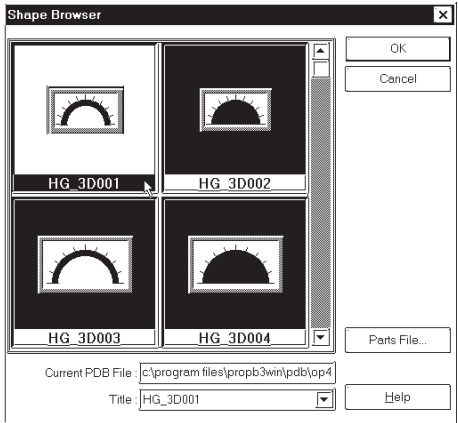
The procedure for placing a Half Pie Graph is as shown below.

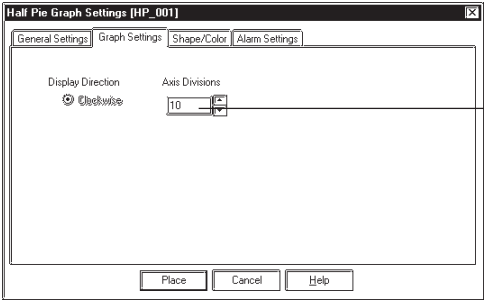

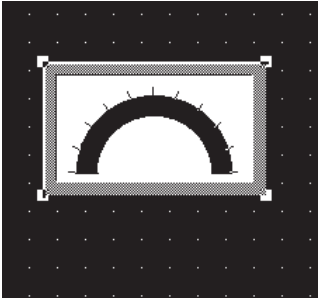
PROCEDURE	REMARKS
<p>(1) Select the [Parts] menu - [Half Pie Graph] command, or click on the  icon.</p> <p>(2) In the [General Settings] area, input the Word Address and Data Format.</p> <div style="display: flex; align-items: center;">  <div style="margin-left: 20px;"> <p>Enter D00102</p> <p>Select BCD</p> </div> </div> <p>(3) Select a Part Shape from the Browser. You can also use the Alarm Settings area to enter Alarm settings and select Colors, if desired.</p> <div style="display: flex; align-items: center;">  </div>	<p style="text-align: center;">Reference <i>2.1 Parts</i> ■ <i>Selecting a Part Shape</i></p>

PROCEDURE	REMARKS
<p>(4) In the [Graph Settings] tab, input the number of axis divisions.</p>  <p style="text-align: right;">Enter 10</p> <p>(5) After all of a Part's attributes have been entered or selected, click on the  button.</p> <p>The Half Pie graph's outline will appear on the Base screen, next to your cursor.</p> <p>(6) Click on the point where the Half Pie Graph's top left corner is to be placed.</p> <p>If desired, use the Half Pie graph's handles to alter its size.</p> 	<p>The area to enter the number of the divisions will appear only for a graph type which has axis divisions.</p> <p>To cancel the placement, click on the  icon.</p> <p>To change the Part's size, refer to Reference 2.4.3 <i>Scaling Up/Down</i></p> <p>Double-clicking on any Part placed on the screen automatically calls up that Part's attribute settings.</p> <p>Reference 2.4.14 <i>Changing Attributes</i></p>

2.1.10 Tank Graphs

This Part creates an area where a Word Address' numeric data received from the Host (PLC) is displayed as absolute or relative values in a special "Tank" shaped graph. The graph's display will change to reflect changes in Word Address data.



Regarding the following parts, if the value of 100 on the scale is displayed, the graph area may not be filled completely depending on display magnification. In this case, the graph can be displayed properly by enlarging or reducing the part by one dot.

- Part file name: op4-3d01.pdb
GR_3D007, GR_3D008, GR_3D010, GR_3D015, GR_3D017
- Part file name: op4-p101.pdb
GR_PL007, GR_PL008, GR_PL010, GR_PL015, GR_PL017

■ Tank Graph [General Settings] Attributes

<When displaying data in absolute values>

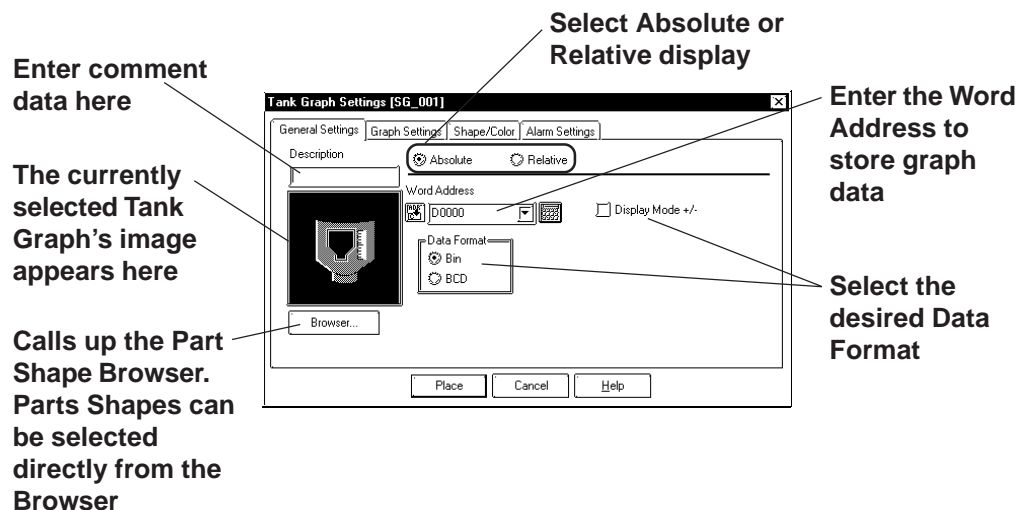

◆ Absolute

Data stored in the designated Word Address is displayed as absolute values, from 0 to 100 (with Display Mode +/- selected, -100 to 100).

◆ Word Address

Enter the Word Address where the data will be stored.

◆ Display Mode

Select the display data format from Bin and BCD.

◆ Display Mode +/-

When this check box is checked and Bin data format is selected, negative numeric data can be displayed.

<When displaying data in relative values>

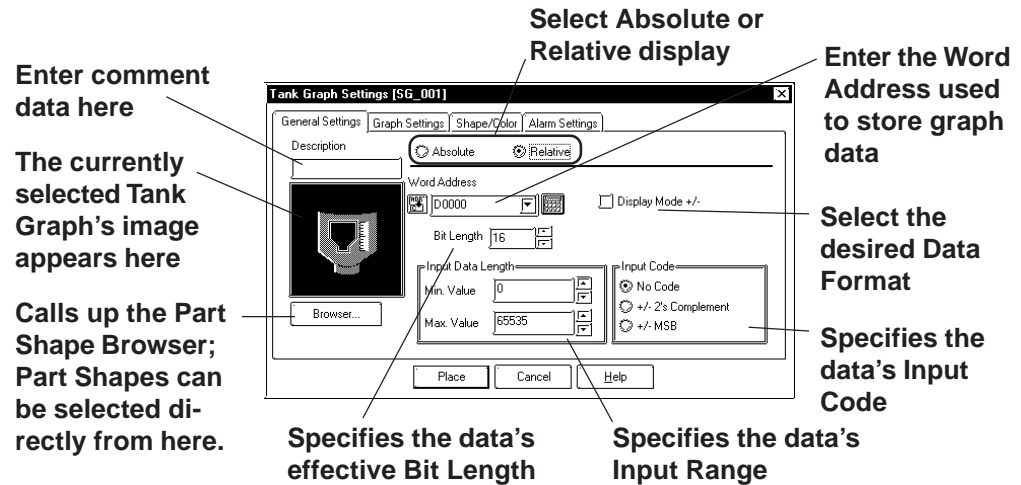
◆ **Relative**

According to the Input Range designated for the Word Address Data the data is converted and displayed as relative values.

◆ **Word Address**

Here, enter the Word Address used to store Tank Graph data.

◆ **Display Mode +/-**

When this check box checked, negative number data can be displayed.

◆ **Bit Length**

Specifies the Bit Length of all data stored in the Word Address.

◆ **Input Data Length**

Specifies the data's Input Range.

◆ **Input Code**

With No Code selected, only positive numeric data can be entered. To enter negative numeric data, select either +/-2's Complement or +/-MSB.

■ Tank Graph [Graph Settings] Attributes

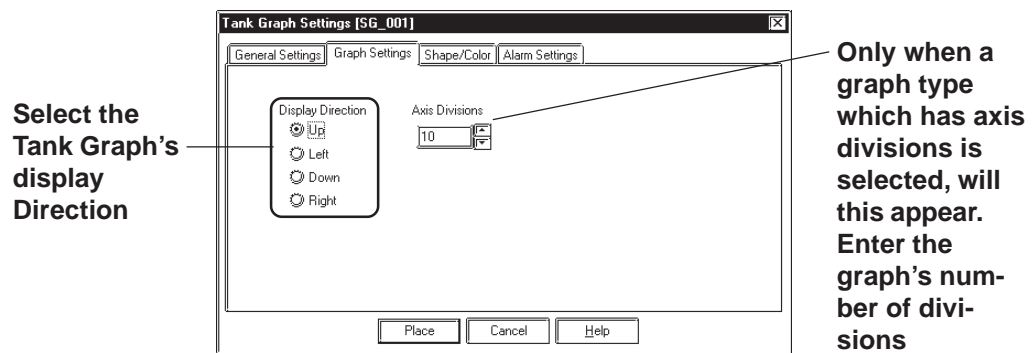

◆ Display Direction

Here, Up, Left, Down, or Right can be selected for the Tank graph's display direction.

The display direction varies depending on the part types.



Note: If [Display Direction] is changed for a 3D part, its shade is rotated along with that part. To let the shade displayed properly, click on the button, and select the part again from [Shape Browser].

◆ Axis Divisions

Here, the Tank Graph's divisions are entered if the graph is a division type. When no divisions are necessary, specify the number of divisions as 0.

Whether a Tank graph has divisions or not will vary depending on the Part Shape selected.

■ Tank Graph [Shape/Color] Attributes

Here, a Tank graph's border color, division color (Axis Color), data display color (Graph Color - Fg & Bg), as well as the data display pattern can all be selected.

Reference 2.1 Parts ■ *Selecting Colors*

■ Tank Graph [Alarm Settings] Attribute

If desired, Alarm Settings can be set here.



Reference 2.1 Parts ■ *Alarm Settings*

■ Placing a Tank Graph

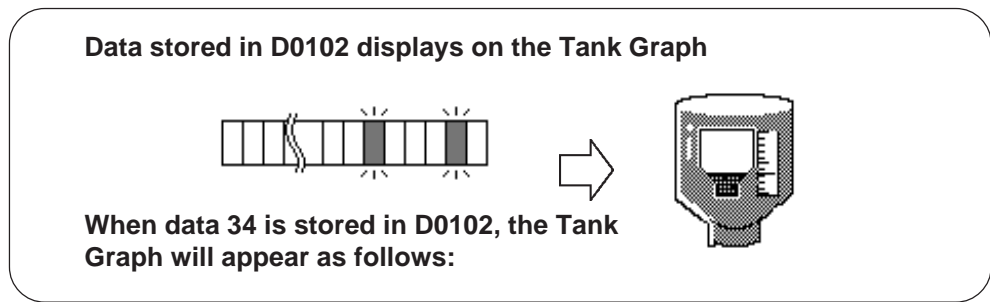
The procedure for placing a Tank Graph is as shown below.

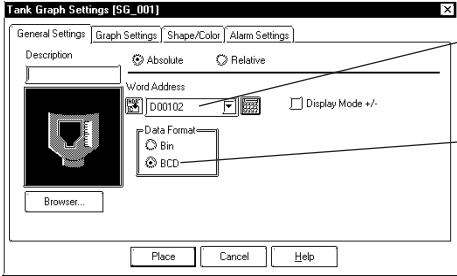
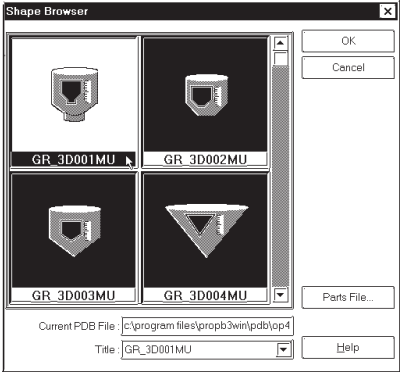

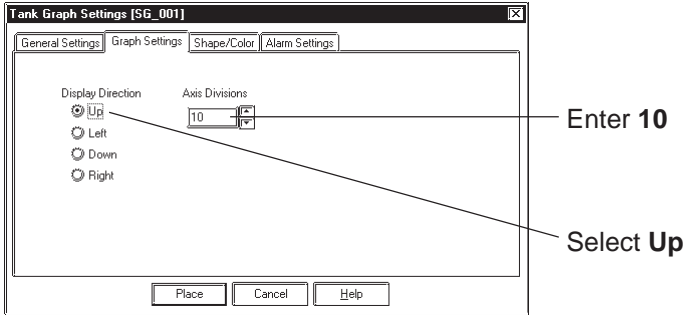
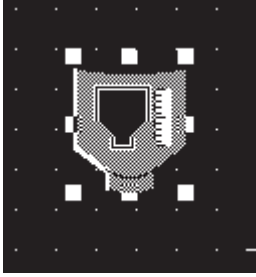
PROCEDURE	REMARKS
<p>(1) Select the [Parts] menu - [Tank Graph] command, or click on the  icon.</p> <p>(2) In the [General Settings] area, input the Word Address and Data Format.</p>  <p>(3) Select a Part Shape from the Browser.</p> <p>You can also use the Alarm Settings area to enter Alarm settings and select Colors, if desired.</p> 	<p style="text-align: center;">Reference 2.1 Parts ■ <i>Selecting a Part Shape</i></p>

PROCEDURE	REMARKS
<p>(4) In the [Graph Settings] tab, input the number of axis divisions and graph data display direction.</p>  <p>(5) After all of a Part's attributes have been entered or selected, click on the <input type="button" value="Place"/> button.</p> <p>The Tank graph's outline will appear on the Base screen, next to your cursor.</p> <p>(6) Click on the point where the Tank Graph's top left corner is to be placed.</p> <p>If desired, use the handles to alter its size.</p> 	<p>The Axis Divisions area will appear only for a graph type which has axis divisions.</p> <p>To cancel the placement, click on the  icon.</p> <p>To change the Part's size, refer to Reference 2.4.3 Scaling Up/Down</p> <p>Double-clicking on any Part placed on the screen automatically calls up that Part's Attribute Settings dialog box.</p> <p>Reference 2.4.14 Changing Attributes</p>

2.1.11 Meters

This Part creates an area where a PLC's Word Address' numeric data is displayed as absolute or relative values in a Meter (i.e. a needle moves to show the value). The graph's display will change to reflect PLC Word Address data changes.

■ Meter [General Settings] Attributes

<When displaying data in absolute values>

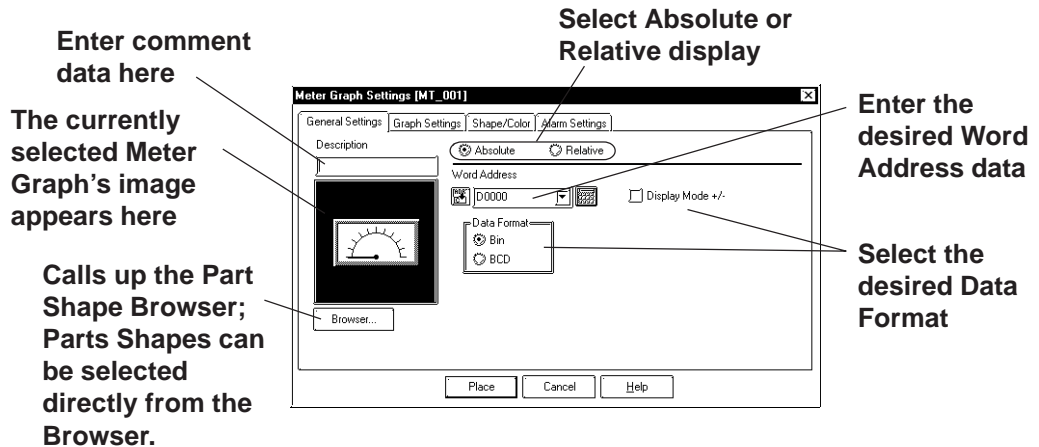

◆ Absolute

Data stored in the designated Word Address is displayed as absolute values, from 0 to 100 (with Display Mode +/- selected, -100 to 100).

◆ Word Address

Enter the Word Address where the data will be stored.

◆ Data Format

Select the display data format from Bin and BCD.

◆ Display Mode +/-

When this check box is checked and Bin data format is selected, negative numeric data can be displayed.

<When displaying data in relative values>

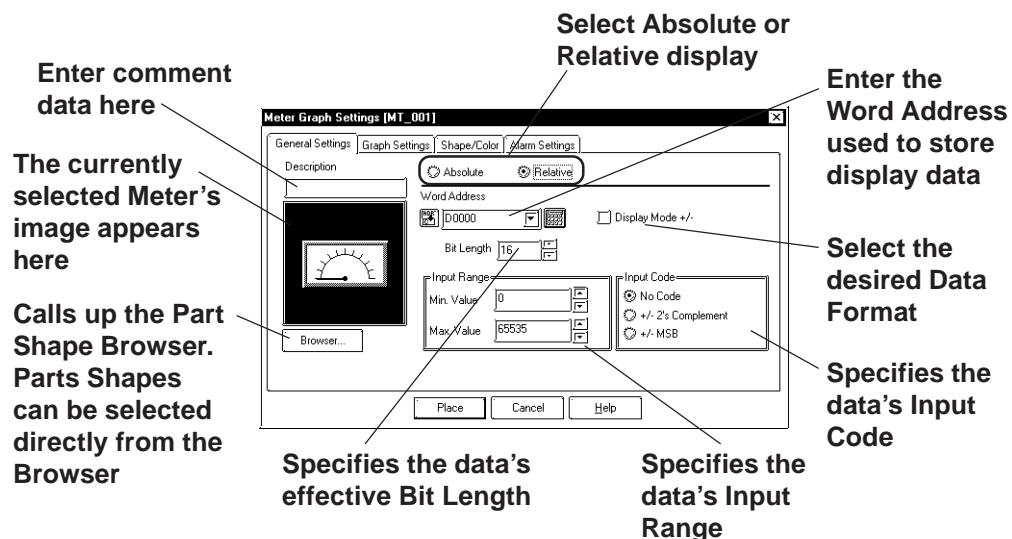
◆ **Relative**

According to the Input Range designated for the Word Address Data, the data is converted and displayed as relative values.

◆ **Word Address**

Here, enter the Word Address used to store Meter data.

◆ **Display Mode +/-**

When this check box checked, negative numeric data can also be displayed.

◆ **Bit Length**

Specifies the Bit Length of all data stored in the Word Address.

◆ **Input Range**

Specifies the data's Input Range.

◆ **Input Code**

With No Code selected, only positive numeric data can be entered. To enter negative numeric data, select either +/-2's Complement or +/-MSB.

■ Meter [Graph Settings] Attributes

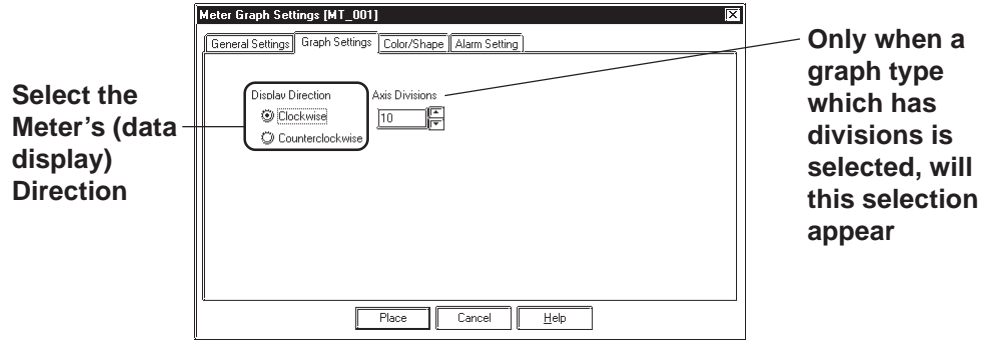

◆ Display Direction

Here, the Meter's display direction, either Clockwise or Counterclockwise can be selected.

◆ Axis Divisions

Here, the Meter increments are entered. If the number of Divisions is specified as 10, 11 division lines are displayed. When no divisions are necessary, simply enter "0".

■ Meter [Shape/Color] Attributes

Here, a Meter's border color, division color (Axis Color), and needle color (Meter Color) can be selected.

▼ **Reference** ▲ 2.1 Parts ■ *Selecting Colors*

■ Meter [Alarm Settings] Attributes

If desired, an Alarm's settings can be set here.



▼ **Reference** ▲ 2.1 Parts ■ *Alarm Settings*

■ **Placing a Meter**

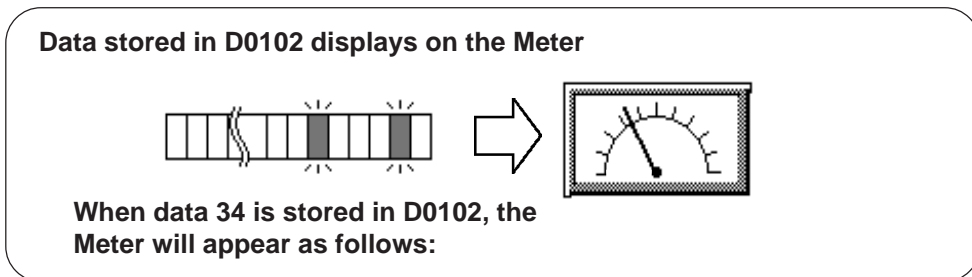
The procedure for placing a Meter is as shown below.

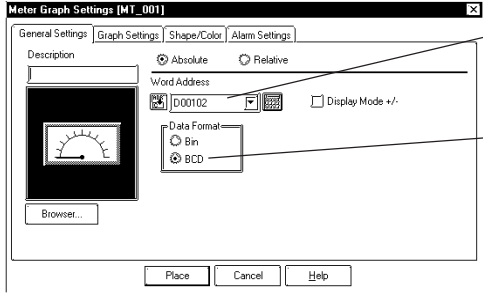
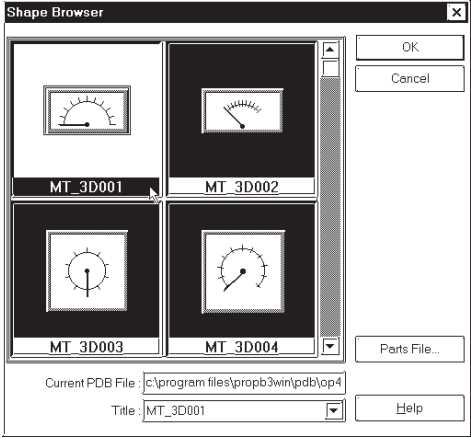

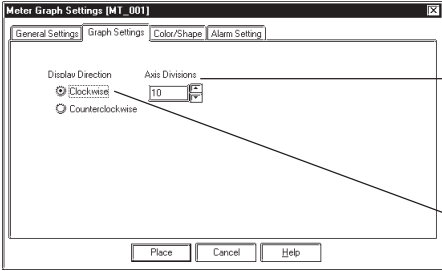
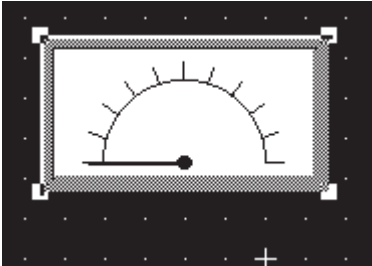
PROCEDURE	REMARKS
<p>(1) Select the [Parts] menu - [Meter] command, or click on the icon.</p> <p>(2) In the [General Settings] area, input the Word Address and Data Format.</p> <div style="display: flex; align-items: center;">  <div style="margin-left: 20px;"> <p>Enter D00102</p> <p>Select BCD</p> </div> </div> <p>(3) Select a Part Shape from the Browser. You can also use the Alarm Settings area to enter Alarm settings and select Colors, if desired.</p> <div style="display: flex; align-items: center;">  </div>	<p style="text-align: center;">Reference 2.1 Parts ■ <i>Selecting a Part Shape</i></p>

PROCEDURE	REMARKS
<p>(4) In the [Graph Settings] area, input the number of divisions and data display direction.</p>  <p>(5) After all of a Part's attributes have been entered or selected, click on the <input type="button" value="Place"/> button.</p> <p>The Meter's outline will appear on the Base screen, next to your cursor.</p> <p>(6) Click on the point where the Meter's top left corner is to be placed.</p> <p>If desired, use the Meter's handle to alter its size.</p> 	<p>The Axis Divisions will appear for a Meter type which has axis divisions.</p> <p>To cancel the placement, click on the  icon.</p> <p>To change the Part's size, refer to Reference 2.4.3 <i>Scaling Up/Down</i></p> <p>Double-clicking on any Part placed on the screen automatically calls up that Part's attribute settings. Reference 2.4.14 <i>Changing Attributes</i></p>

2.1.12 Trend Graphs

This Part displays Word Address numeric data as absolute values on a Trend (line) graph. The graph's display will then change to reflect Word Address data changes.

■ Trend Graph [General Settings] Attributes

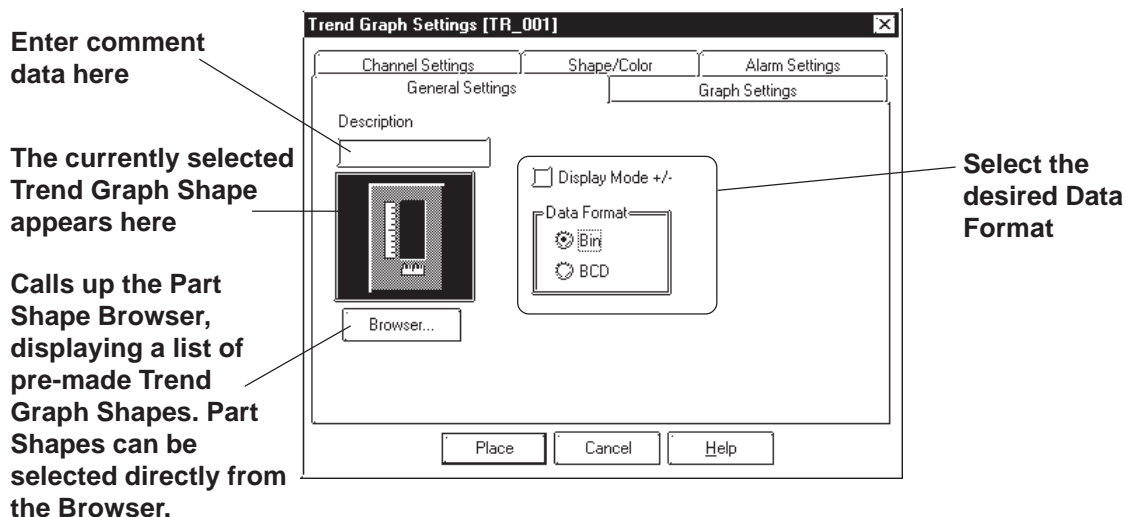

◆ Data Format

Here, the display data format is specified as either Bin or BCD. With the Display Mode +/- check box checked, and Bin data format selected, negative numeric data can also be displayed.

■ Trend Graph [Graph Settings] Attributes

Select a graph type

Select the data display direction

Enter the No. of Samples, Scroll value, and Sampling Time

Enter the number of X and Y divisions

Note:

◆ Graph Settings

Using “Normal”: The specified Word Address’s data changes are displayed over time in a Trend Graph. Display data always starts at the “0” point. As each (time) sampling period elapses, the latest data is added in the specified display Direction. When the graph’s poly (gonal) line reaches the limit of the Trend Graph, the graph is shifted in the display Direction for the number units specified in “Scroll”.

E.g.) Display Direction: Right

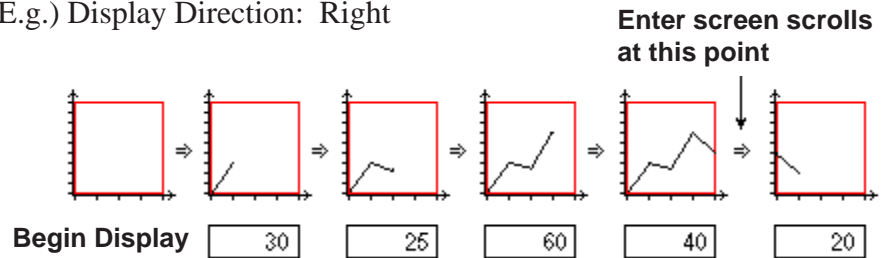

Using “Pen-Recorder”:

A specified Word Address’s data changes are displayed over time in a Trend Graph. The data’s display always begins with “0”. As each sampling period elapses, the graph’s poly(gonal) line is shifted one division opposite the specified display Direction. The latest data is always displayed at the very limit (in this example, the right side) of the Trend Graph’s display area.

E.g.) Display direction: Right

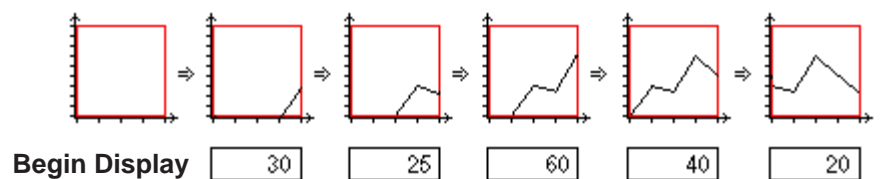

◆ **Data Samples**

Data Samples: The number of data “units” to be displayed in a single Trend Graph. Up to 638 can be used.

Scroll: The number of data units to be scrolled when the polygonal line reaches the limit of the Trend Graph’s display area.

Sampling Time: The data read interval (from the host PLC) is input in seconds.

◆ **Display Direction**

Select the Trend Graph’s display direction, either Up, Left, Down, or Right.

If [Display Direction] is changed for a 3D part, its shade is rotated along with that part. To let the shade displayed properly, click on the button, and select the part again from [Shape Browser].

◆ **Axis Scale**

Enter the number of units that the X and Y axes are to be divided into. When no divisions are necessary, input “0”.

■ **Trend Graph [Channel Settings] Attributes**

◆ **Number of Channels**

Enter the number of channels used in the Trend Graph. Use the “Current Channel” area to select which channel is being specified. Up to 8 channels can be designated for a single screen, and up to 20 channels can be entered in a Project file (PRW file).

◆ **Word Address**

Enter the Word Address used to indicate where the Trend graph’s data is stored.

■ Trend Graph [Shape/Color] Attributes

The Trend Graph's border color, division color (Axis Color), and Trend Graph's display area color (Graph Area Color) can be selected.

▼ **Reference** ▲ 2.1 Parts ■ *Selecting Colors*

■ Trend Graph [Alarm Settings] Attributes

If desired, an alarm's settings can be set here.

▼ **Reference** ▲ 2.1 Parts ■ *Alarm Settings*

■ Placing a Trend Graph

An example of a Trend Graph (scrolling left to right) is shown below.

Data stored in D0102 is displayed on the Trend Graph

When 34 is stored in D0102 the graph will look like this:

Axis Settings
 * Sample 20
 * Scroll 19
 * Sampling Time 10 sec
 * Axis Div. (Ver.) 10
 " " (Hor.) 10

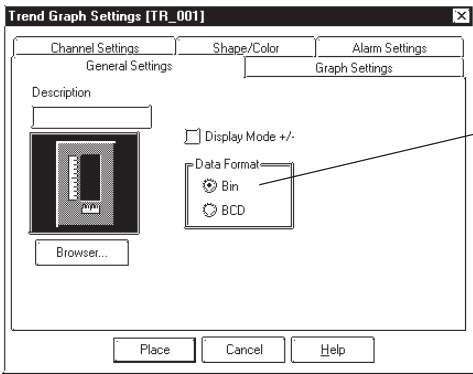
PROCEDURE	REMARKS
<p>(1) Select the [Parts] menu - [Trend Graph] command, or click on the  icon.</p> <p>(2) After clicking on the [General Settings] tab, select the data format.</p> 	<p>Data in the range of 0 to 100 can be displayed on the Trend Graph. When the data range is from -100 to 100, check the Display Mode +/- check box.</p>

PROCEDURE	REMARKS
-----------	---------

(3) Select a Part Shape from the Browser.

You can also use the Alarm Settings area to enter Alarm settings and select Colors, if desired.

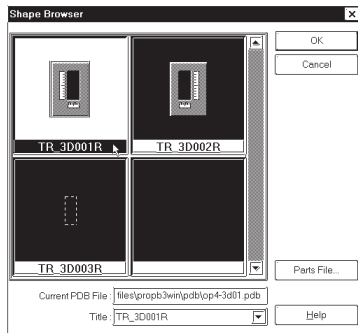

Reference 2.1 Parts ■ *Selecting a Part Shape*

(4) In the [Graph Settings] area, select the Graph Type and Direction, and enter the number of Data Samples and Axis Divisions.

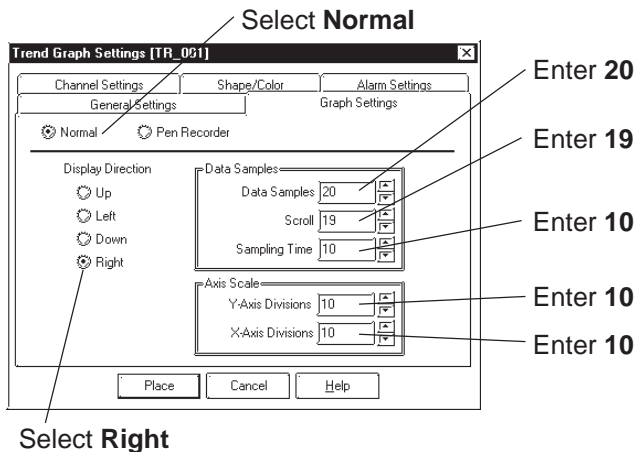

If the more than one channel is used, be sure to enter the Word Address and select the Color for each channel before placement.

(5) In the Channel Setting area, enter the Number of Channels, then enter each channel's Word Address and select the desired colors.



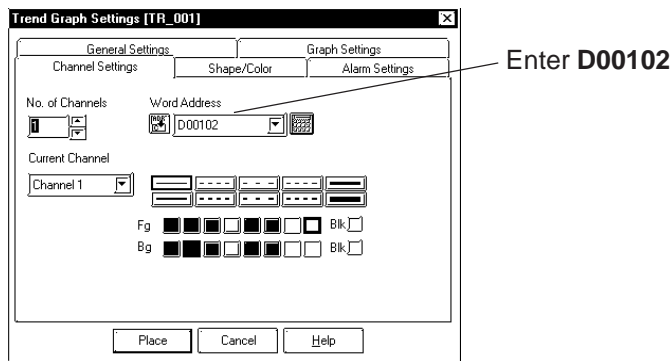

In this example, since the Number of the Channels is "1", you only need to enter one Word Address.

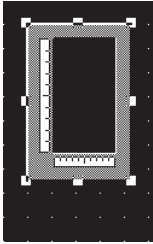

A Trend Graph's channel Word Addresses should not be the same as other Part addresses, otherwise, it will cause a GP error.

Up to 20 channels can be designated for a Project file (including the Data Sampling frequency number).

Up to 8 Trend Graph display areas can be placed on a single screen.

PROCEDURE	REMARKS
<p>(6)After all of Part's attributes have been entered or selected, click on the  button.</p> <p>The Trend Graph's outline will appear in the Base screen, next to your cursor.</p> <p>(7)Click on the point where the Trend Graph's top left corner is to be placed.</p> <p>If desired, use the Trend Graph's handles to alter its size, after placement.</p> 	<p>To cancel the placement, click on the  icon.</p> <p>To change a Part's size, refer to Reference  2.4.3 Scaling Up/Down</p> <p>Double-clicking on any Part placed on the screen automatically calls up that Part's attribute settings.</p> <p>Reference  2.4.14 Changing Attributes</p>

2.1.13 Keypads

Here, pre-made keypads are used to enter data to a designated Word Address. In order to input data via the keypad, it is necessary to first create a Keypad Input display.

Reference 2.1.14 Keypad Display

■ Keypad [Description] Attributes

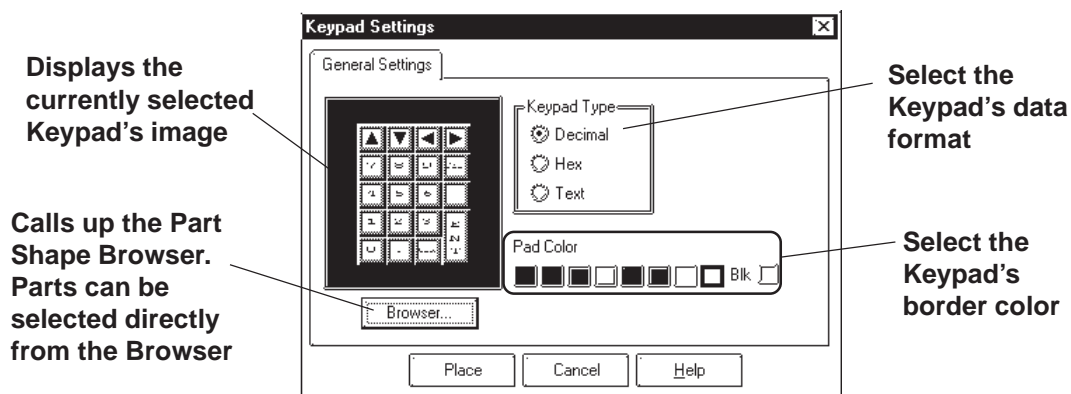

◆ Keypad Type

First, a Keypad type needs to be selected that will be suitable for the data format specified. To select a Keypad type, simply click on the Browser and the selection of available Keypads will be displayed.

◆ Pad Color

The Keypad's border color (Pad Color) can be selected here.

■ Keypad Key Functions

The various Keypad Key functions are shown in the table below.

	Decimal	Hexadecimal
Keypad Specs		
Common Keys		Numeric value keys (for Hex, the keys are 0 to F). Inputs the corresponding value in the display.
		Delete key Deletes the character above the cursor.
		Clear key Clears the entire display. If the is pressed after clearing, 0 is stored in the PLC Word Address.
		Enter key Registers the set value and writes it to the PLC Storage Address. Then, the cursor moves to the next display and awaits next input.
		Cursor keys Moves the cursor right and left within the display.
	Jump keys Moves to the next Key Display without entering the set value. You can use these keys to jump to the area where you wish to enter data.	
Dec. Only keys		Negative key Only available for Dec(imal) and +/- format.
		Decimal Point key Valid when Decimal Places have been entered for Decimal and BCD numbers.

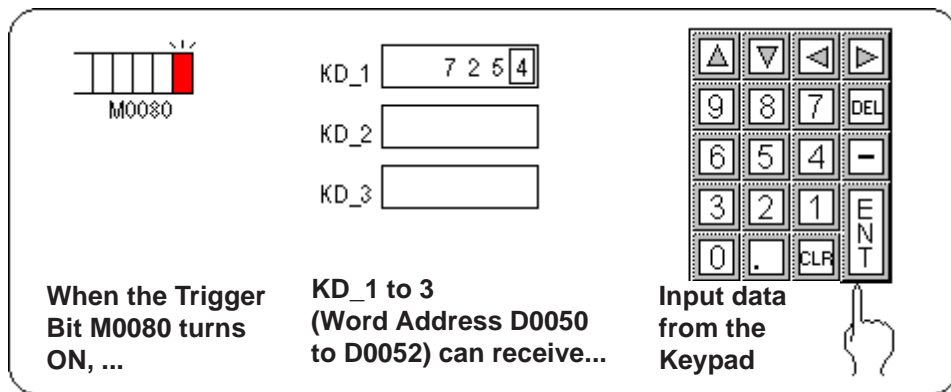

■ **Placing a Keypad**

The procedure for creating and placing a keypad is shown below.

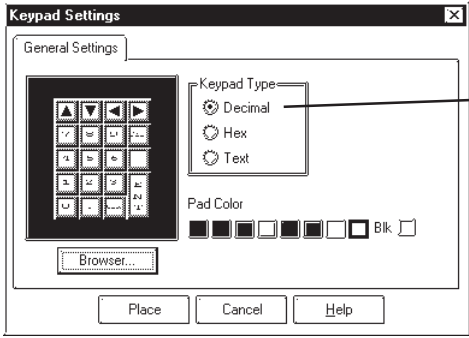
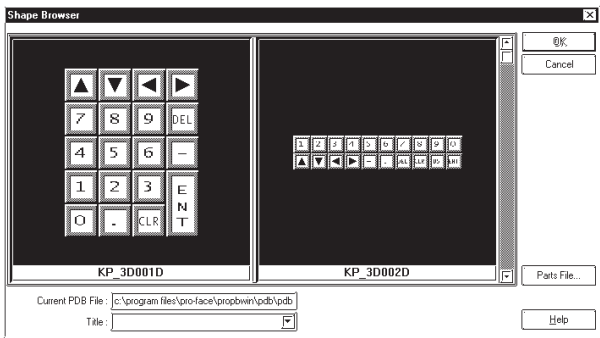

▼ **Reference** ▲ For how to create the display area for the keypad shown here, refer to *2.1.14 Keypad Display*.

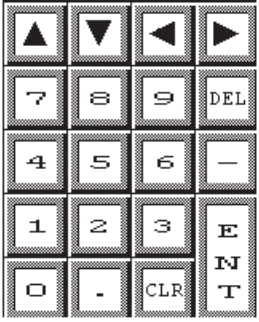
PROCEDURE	REMARKS
<p>(1) Select the [Parts] menu - [Keypad] command, or click on the  icon.</p> <p>(2) Select a Keypad Data Format Type.</p>  <p>(3) Select a Keypad Shape from the Browser. If desired, select a color from the Shape/Color area.</p> 	<p>▼ Reference ▲ <i>2.1 Parts</i> ■ <i>Selecting a Part Shape</i></p>

PROCEDURE	REMARKS
<p>(4)After all of the Keypad’s attributes have been entered or selected, click on the  button. The Keypad’s outline will then appear in the Base screen, next to your cursor.</p> <p>(5)Click on the point where the Keypad’s top left corner is to be placed.</p> 	<p>To cancel the placement, click on the  icon.</p> <p>Double-clicking on any Part placed on the screen automatically calls up that Part’s attribute settings.</p> <p>Reference  <i>2.4.14 Changing Attributes</i></p>



Regular Keypad parts have all been previously grouped. Therefore, to create a new keypad, simply un-group the Keypad and arrange the pieces as you like.

Reference  *2.4.12 Group/Ungroup*

2.1.14 Keypad Display

This section describes the procedure for creating an area for displaying the data input from the keypad.

Touching the Keypad Input Display can automatically call up a pop-up keypad. When not using the pop-up keypad, place an additional keypad separately from the Keypad Input Display.



Note: The pop-up keypad is automatically set up by placing the Keypad Input Display. Setting up an additional keypad is not required.



Important The pop-up keypad feature is supported exclusively by the GP-377, GP77R and GP2000 series.

■ Keypad Display [General Settings] Attributes

Enter comment data here

The currently selected Part's image will appear here

Calls up the Part Shape Browser. Parts can be selected directly from the Browser

Enter the Word Address used to store display data

Enter the Trigger Bit Address to allow you to perform data settings via the Keypad

Select this option to display a keypad when the GP screen's Keypad Input Display is touched.

◆ Word Address

The Word Address is used to store the keypad display's data.

◆ Trigger Bit Address (When not using the Pop-up keypad feature.)

When this bit is turned ON, the Keypad's data entry area becomes active.

◆ Use Pop-up Keypad

When this option is selected, touching the Keypad Display will automatically display the pop-up keypad on the screen. When this option is selected, the Trigger Bit Address is disabled.

Keypad Display [Display Format] Attributes

Select either Numeric or Text for the data's display format

When Numeric is selected, these selections appear. Select the Data Length and Data Format

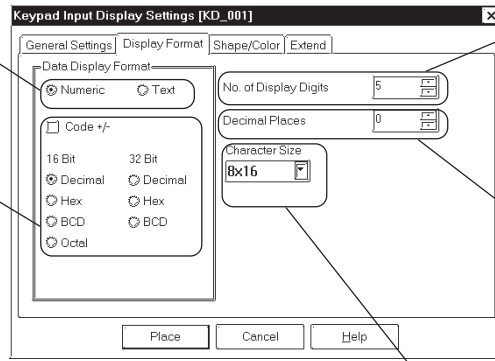

The decimal point is not included in the display digits. Enter the No. of Display Digits

Enter the No. of Digits after the decimal point

Character size can be selected here

◆ Data Display Format

Here, the data's Format, Code and Bit Length are selected. When selecting decimal, negative numeric data can also be displayed by clicking on  the "Code +/-" check box.

◆ No. of Display Digits

Here, the number of digits displayed, to the right of the decimal point, is input.

◆ Decimal Places

Here, the number of digits to the right of the decimal point is input.

Each data format available is listed in the table below.

Data Format		Code	Data Length	Display Digits	Decimal Places
Data Values	Dec	+/-	16 bit	1-5	0-4
	Hex	+		1-4	
	BCD	+		1-4	0-3
	Oct	+		1-6	
	Dec	+/-	32 bit	1-10	0-9
	Hex	+		1-8	
	BCD	+		1-8	0-7
Char. Col.			No. of Char.	1-80	

When using 32 bit data, the relationship between the top and bottom of the Word Address will differ depending on the PLC used.

Reference *Device/PLC Connection Manual*



Note: When the No. of Display Digits is set to 5 and the Decimal Places is set to 2, a value appears on the Keypad Input Display as shown below.

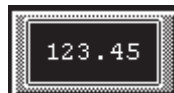

◆ Character Size

The label's character size is selected here.

▼ **Reference** ▲ 2.2.9 Text

■ Keypad Display [Color/Shape] Attributes

The Keypad Display's border color, data display color (Text), and interior color (Plate) are selected here.

▼ **Reference** ▲ 2.1 Parts ■ *Selecting Colors*

■ Keypad Display [Extend] Attributes

Select the desired input style.

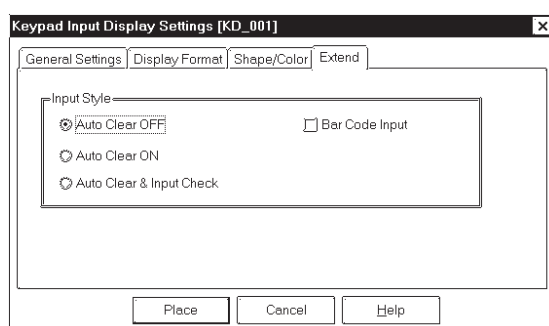

◆ Input Style

• Auto Clear OFF

The previous input is not cleared and displayed in the input area. The new input is appended to existing data. To clear the existing values, enter "CLR" from the Touch Keypad.

• Auto Clear ON

The previous input is cleared when the first character (except the cursor keys, ENT, DEL and BS keys) is entered.

• Auto Clear & Input Digit Monitor

When barcode input is performed in this mode, the Auto Clear function is enabled and the input data are monitored so that it matches the No. Display Digit. If the data length is inappropriate, it is not written into the word address. When data is input from the Touch Keypad, only the Auto Clear function is enabled.





• Barcode Input

Selecting this feature enables input from the Touch Keypad and barcode readers.

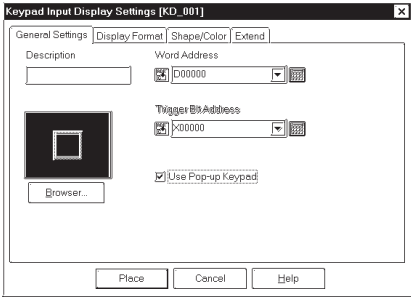
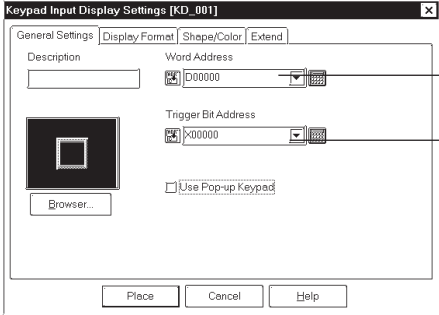
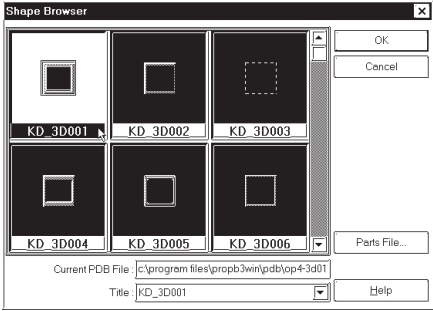
■ **Placing a Keypad Display**

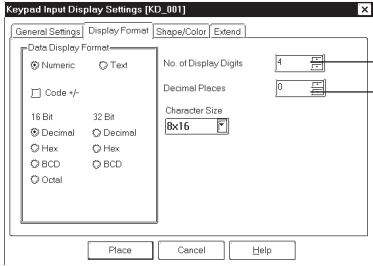
The Keypad Display’s placement procedures are shown below.

PROCEDURE	REMARKS
<p>(1) Select the [Parts] menu - [Keypad Input Display] command, or click on the  icon.</p> <p>(2) Make the following settings on the [General Settings] tab. [When using the Pop-up Keypad] Place a check mark in the [Use Pop-up keypad] box.</p>  <p>[When not using the Pop-up keypad] Input the word address and the trigger bit address.</p>  <p style="margin-left: 450px;">Enter D00050</p> <p style="margin-left: 450px;">Enter M0080</p> <p>(3) Select a Part Shape from the Browser. If desired, select colors from the [Shape/Color] area and input the extension settings.</p> 	<p>When [Use Pop-up keypad] is selected, the Trigger Bit Address is disabled.</p> <p style="margin-top: 150px;">Reference 2.1 Parts ■ <i>Selecting a Part Shape</i></p>

PROCEDURE	REMARKS
<p>(4) In the [Display Format] area, specify the Data Display Format, No. of Display Digits, and Decimal Places (i.e. number of the digits after the decimal point) to be used. If desired, select the Character Size.</p>  <p>(5) After all of the Keypad Display's attributes have been entered and selected, click on the  button.</p> <p>The Keypad Display's outline will appear on the Base screen, next to your cursor.</p> <p>(6) Click on the point where the Keypad Display's top left corner is to be placed.</p> <p>If desired, use the Keypad Display's handles to alter its size.</p> <p>Even though the set value display area is scaled up or down, the character size will not change. To change the character size or position, directly select the characters inside the border.</p>  <p>(7) Repeat from step (1) to create Keypad Displays with Word Addresses "D00051" and "D00052".</p> <p>Except for the addresses, all settings should be the same.</p>	<p>When placing the Keypad Input Display, do not rotate it. Doing so will cause the Pop-up keypad to display in the incorrect orientation.</p> <p>To cancel the placement, click on the  icon.</p> <p>To change the Part's size, refer to Reference 2.4.3 <i>Scaling Up/Down</i></p> <p>Double-clicking on any Part placed on the screen automatically calls up that Part's attribute settings.</p> <p>Reference 2.4.14 <i>Changing Attributes</i></p> <p>If the  key is pressed when the display area's border is scaled up or down, its interior characters are also scaled.</p>

■ Using a Keypad to Input Values

◆ When not using the Pop-up keypad

The procedures for entering setting values via a Keypad on the GP screen are shown below.

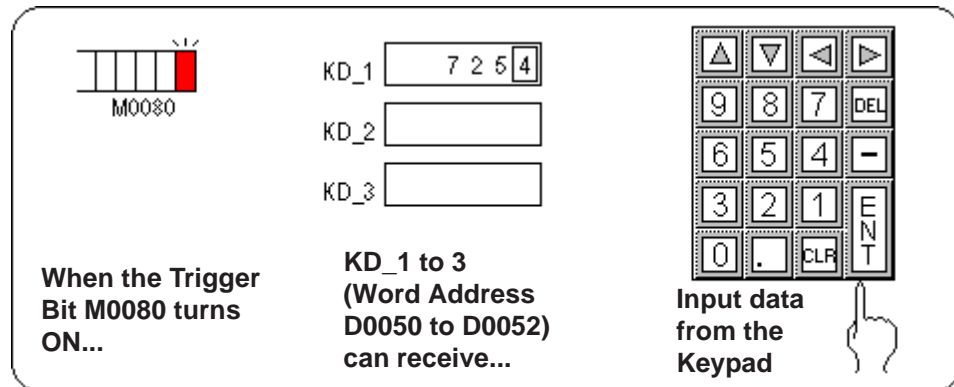

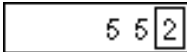
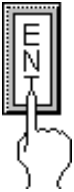
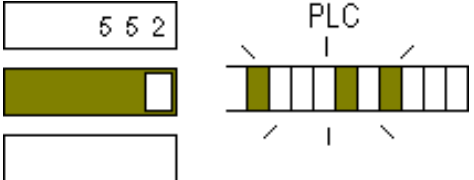

PROCEDURE	REMARKS
<p>(1) Here, three Direct Call-Ups have been set to share a common start bit.</p> <p style="text-align: center;">ID No.</p> <p><input type="text"/> — KD_1</p> <p><input type="text"/> — KD_2</p> <p><input type="text"/> — KD_3</p> <p>(2) Then, when the PLC's internal Trigger Bit M0080 turns ON,</p> <p style="text-align: center;">PLC</p> <p>(3) First, the Keypad Display KD_1's display reverses (highlights) and waits for input. The square box shown below represents the cursor's position.</p> <p><input style="background-color: #cccccc;" type="text"/> <input style="border: 1px solid black; width: 15px; height: 15px;" type="text"/></p> <p><input type="text"/></p> <p><input type="text"/></p>	<p>▼ Reference ▲ For how to create a Keypad, refer to 2.1.13 Keypads</p> <p>▼ Reference ▲ For how to create a Keypad Display, refer to 2.1.14 Keypad Display ■ Placing a Keypad Display</p>

PROCEDURE	REMARKS
<p>(4) Press the Keypad's keys to input the desired value.</p>  <p>(5) Press the [ENT] key to register the value.</p>  <p>(6) The registered value will then be stored in Word Address D0050, which was designated in KD_1. Next, KD_2 will be highlighted and be ready to receive input.</p> 	<p>Set value display areas having a common Trigger Bit will enter a wait state in order, from the lowest ID number upwards. After the first value has been registered, the next value's display area will automatically be ready to receive input.</p>

◆ When using the Pop-up keypad

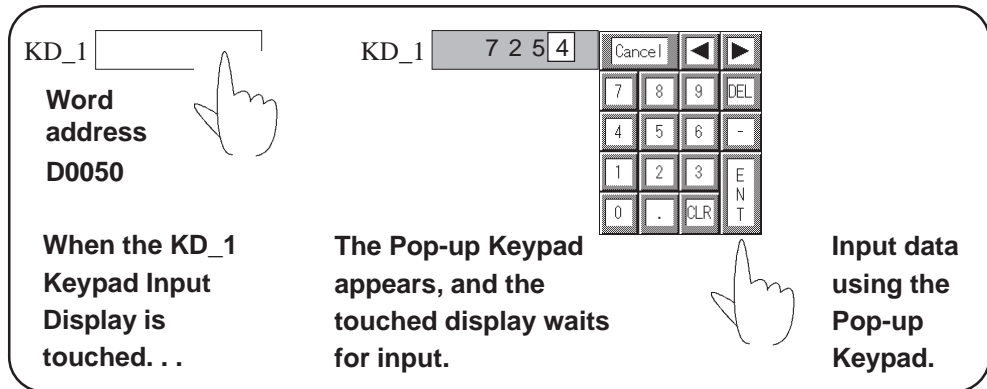
The procedure for positioning the Keypad Input Display featuring the Pop-up Keypad is shown below.

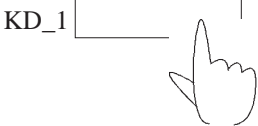
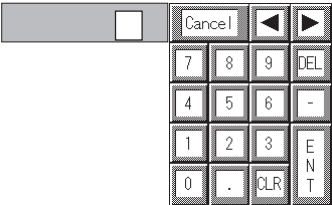
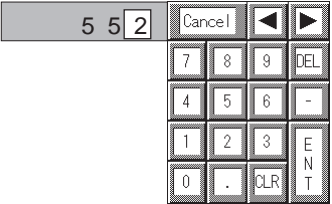

PROCEDURE	REMARKS
<p>(1) The Keypad Input Display "KD_1" is displayed on the GP screen.</p> <p style="text-align: right;">ID Number</p> <p style="text-align: center;">KD_1</p> 	<p>For how to create a Keypad Display, Reference 2.1.14 Keypad Display ■ Placing a Keypad Display</p>
<p>(2) When the KD_1 Keypad Input Display is touched. . .</p> 	
<p>(3) The Pop-up Keypad appears, and the touched display waits for input.</p> <p>The square box shown below represents the cursor's position.</p> 	
<p>(4) Touch the appropriate key on the Pop-up Keypad to enter the value.</p> 	
	<p>Select this option to display a keypad when the GP screen's Keypad Input Display is touched.</p> <p>In the following two cases, the pop-up keypad will disappear with no confirmation of the input during data input:</p> <ul style="list-style-type: none"> • When the active Keypad Input Display is touched • When another Keypad Input Display is touched during data input (only when the [Use Pop-up keypad] feature is enabled for Keypad Input Display) <p>The Keypad Input Display that has been touched becomes active and is displayed in reverse video, calling up the pop-up keypad for display on the screen.</p>

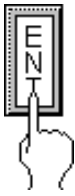
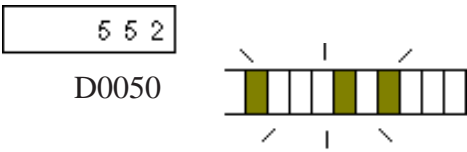
PROCEDURE	REMARKS
<p>(5) Press the ENT key to register the value. The Pop-up Keypad will then close.</p>  <p>(6) The registered value will then be stored in Word Address D0050, which was designated in KD_1.</p> 	<p>When [Cancel] is touched, the Pop-up Keypad closes without registering the input value.</p>

◆ **Notes for using Pop-up Keypad**



- Do not specify [High Speed] from [Designated Window] of a U-tag when using Pop-up Keypad with the Keypad Input Display.
- Do not rotate the Keypad Input Display when you position it. Otherwise, the Pop-up Keypad will not appear in the proper orientation.

◆ **Restrictions for using Pop-up Keypad**

- If the Keypad Input Display selected does not use the Pop-up Keypad feature or if the trigger bit in the K-tag is set to ON, the Pop-up Keypad will not appear.
- The Pop-up Keypad will appear to the right of the Keypad Input Display.
If there is insufficient space to the right of the Keypad Input Display to display the Pop-up Keypad, the Keypad automatically appears in a position either above, below, or to the left of the Keypad Input Display.
- If there is insufficient space in each of these positions, the Keypad will appear in the lower right corner of the screen. In this case, the Pop-up Keypad and the Keypad Input Display may overlap so that you cannot see the input value.
- The Pop-up Keypad is displayed as a local window. When two local windows are already displayed on the screen, the Pop-up Keypad does not appear even if the Keypad Input Display is touched. In this case, the Keypad Input Display will not wait for input.
- When the pop-up keypad and other windows overlap, touch the desired window to bring it to the front.

■ Editing the Pop-up Keypad

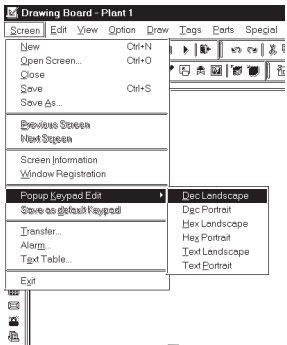
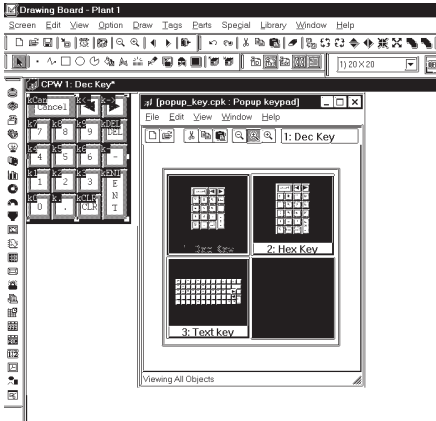
When a check mark is added to [Use Pop-up Keypad] in the [General Settings] tab of the [Keypad Input Display], a keypad is displayed that is preset with the [Display Data Format] settings in [Display Format]. However, the keypad settings can be edited to your preference.

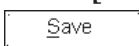
PROCEDURE	REMARKS
<p>(1) Select the [Screen] menu - [Popup Keypad Edit] command.</p> <p>(2) Select the type of Pop-up Keypad to use ([Dec Landscape],[Dec Portrait],[Hex Landscape],[Hex Portrait],[Text Landscape]or [Text Portrait].) The editing screen for the Pop-up Keypad appears.</p>  	<p>When "GP***** Vertical Type" is selected as the GP Type, a pop-up keypad for the vertical type is displayed. When editing the pop-up keypad, select a keypad designed for the vertical type.</p> <p>The library browser automatically opens. You can select a keypad from the library.</p> <p>The CPK file displayed here cannot be edited.</p> <p>You can also create a keypad as desired.</p> <p>▼ Reference 3.3 <i>Creating a Keypad: the Keypad Screen</i> ■ <i>Creating a Keypad (3)</i></p> <p>Do not use the   keys. They are non-functioning on the pop-up keypad.</p> <p>When the range of the clear area is specified, the X-axis can be specified in units of eight dots. Fractions will be automatically translated into eight-dot units. The Y-axis can be specified arbitrarily.</p> <p>When saving the edited Pop-up keypad, select [Save as default Keypad] from the [Screen] menu. The pop-up keypad will be used as the default keypad for all future projects.</p>
<p>(3) Edit the Pop-up keypad. When changing the size and place of the Pop-up Keypad, a clear area must be changed. Specify a clear area to surround the entire pop-up keypad.</p> <p>(4) Select [Save] from the [Screen] menu or click the  icon to save the pop-up keypad you have edited. This will be used as the Pop-up keypad within the project.</p>	

2.1.15 Alarm Display

When the PLC Monitor Bit has been turned ON, messages registered in the Alarm Summary by the Alarm Editor, can be displayed in a list.

Reference Chapter 5 CREATING AND EDITING ALARMS

Message display order is decided according to which Monitor Bit is in the lowest position in the Alarm Summary display area. It is recommended that Monitor Bit assignment begins from the message with the highest priority. Be sure to input only one message per line. The characters of a message that exceed one line will be truncated.

The number of the characters that can be displayed in one line will vary depending on the character size and GP type. When the size is 1 x 1, the maximum number of characters that can be displayed per line for each GP model is:

Maximum Number of Characters	GP Type
40	GP-H70, GP-270, GP-370, GP-377, GP-377R, GP-2301H, GP-2300, GP-2301
80	GP-470, GP-570, GP-571, GP-870, GP-477R, GP-577R, GP-2401H, GP-2400, GP-2500, GP-2501
100	GP-675, GP-2600

Alarm Summary [Description] Attributes

Border Type

The display area frame types are No Border, Outside, and Outside + Inside.

Word Address

The Monitor Bit's first address for the messages specified by the Alarm Editor is input. Input this address in word units.

E.g.) How to designate a Word Address (MELSEC-A Series - Mitsubishi):
When designating the Word Address for the input/output or internal relay, the Word Address is designated from the Least Significant Bit.



← High Low → LSB

In this case, M0144 is designated

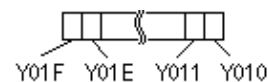

← High Low → LSB

In this case, Y010 is designated

◆ **No. of Monitor Words**

Here, the number of words a Monitor Bit is assigned and entered. Up to 100 words can be monitored.

■ **Alarm Summary [Display Format] Attributes**

■ **Display Start Line**

Among the messages whose Monitor Bit is turned ON, the Start Line designates from which message the display starts.



Note: When the Alarm Summary display cannot fit in a single screen:

Only one Alarm Summary display can be placed on a screen. When the number of messages to be displayed does not fit on one screen, create Alarm Summary displays on multiple screens, so that the screens will switch to display all the messages. To display all error messages continuously, specify each screen's Start Line as follows:

- The first screen: The starting line
- The second screen: The number of display lines on the first screen + 1
- .
- .
- .
- The nth screen: The number of display lines on any screen x (n-1) + 1

◆ **No. of Display Lines**

Designates the maximum number of alarm message lines that can be displayed on one screen. Up to 50 lines can be displayed.

◆ **No. of Display Char.**

Designates the maximum number of characters that can be displayed on a line. The screen's limit is 100 characters per line. However, the maximum number of characters for each GP unit will vary depending the model.

■ **Alarm Summary [Style/Color] Attributes**

The display area color when a message is cleared (Clear Color) is selected.

▼ **Reference** ▲ 2.1 Parts ■ **Selecting Colors**

■ Placing an Alarm Summary Display Area

The Alarm Summary Display Area's setting procedure is shown below.

No.	Bit Address	Type	Message
1	X00010	Summary	ErrorCode030 Unit 0D5
2	X00050	Summary	ErrorCode040 Unit 0D5
3	X00051	Summary	ErrorCode041 Unit 0D6

ErrorCode030 Unit 0D5

ErrorCode040 Unit 0D5



ErrorCode041 Unit 0D6

⋮

100 Alarm Messages, have been assigned to bits M0800 ~ M0899 in the Alarm Editor

Appear on the screen in a Summary Display, at 10 lines by 30 characters per display.

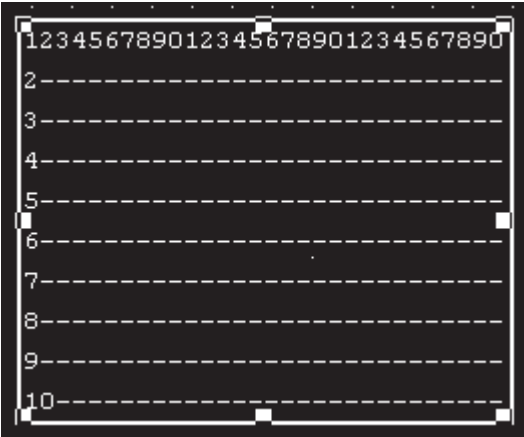
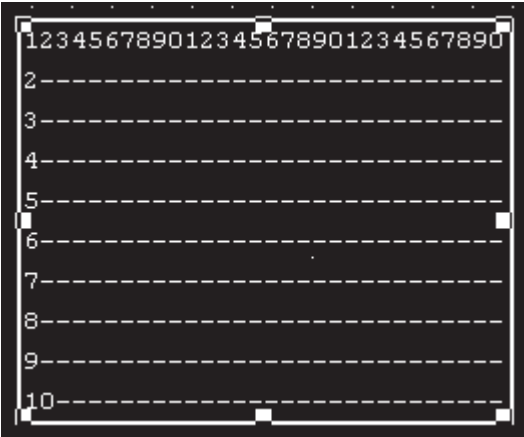
PROCEDURE	REMARKS
<p>(1) Select the [Parts] menu - [Alarm Display] command, or click on the icon.</p> <p>(2) In the [General Settings] tab, input the Word Address, No. of Monitor Words, and select one of the Show Border options. Here, since the Word Address range is from M0800 to M0899, enter "7" for the number of Monitor Words.</p> <div style="border: 1px solid black; padding: 5px; margin: 10px 0;"> </div> <p style="margin-left: 40px;">Enter M0800</p> <p style="margin-left: 40px;">Enter 7</p> <p style="margin-left: 40px;">Select Border type</p> <p>(3) In the [Display Format] tab, input the Display Start Line, No. of Display Lines, and No. of Characters. In the [Style/Color] tab, select the Clear(ing of Data) Color, if desired.</p> <div style="border: 1px solid black; padding: 5px; margin: 10px 0;"> </div> <p style="margin-left: 40px;">Enter 1</p> <p style="margin-left: 40px;">Enter 10</p> <p style="margin-left: 40px;">Enter 30</p>	<p style="text-align: center; font-weight: bold; font-size: 1.2em;">REMARKS</p> <p style="margin-top: 20px;">Reference 2.1.15 Alarm Display ■ Alarm Summary [Description] Attributes ◆ Word Address</p>

PROCEDURE	REMARKS
<p>(4)After all of the Part’s attributes have been entered and selected, click on the  button. The Alarm Summary display area’s border will appear in the Base screen, next to your cursor.</p> <p>(5)Click on the point where the Alarm Summary display area’s top left corner is to be placed. If desired, use the Alarm Summary display handles to alter its size. When the Alarm Summary display is scaled up or down, the displayed character size will also change, according to the border’s size.</p> 	<p>To cancel placement, click on the  icon.</p> <p>To change the Part size, refer to Reference 2.4.3 Scaling Up/Down</p> <p>Double-clicking on any Part placed on the screen automatically calls up that Part’s Attribute Settings dialog box.</p> <p>Reference 2.4.14 Changing Attributes</p> <p> <i>Important</i></p> <p>Be sure to use the Alarm Summary’s display area only for displaying Alarm Messages, i.e. never place, overlap, or overlay another Part or object in this area.</p>

2.1.16 File Name Display

Data registered in the Filing Data settings is displayed.



Set up the Filing Data Settings before placing the File Name Display. For information on registering the Filing Data:

Reference *Tag Reference Manual, 4.2 Filing Data (Recipe) Function*

■ File Name Display [General Settings] Attributes

Enter a description if desired

Enter the ID number for the File Name Display and its function switch

Enter the File No. of filing data to be displayed.

Specify whether or not to use the LS area

Enter the start word address of the LS area

Set up the PLC Transfer Completed Bit Address.

◆ Description

Enter a description using a maximum of 20 single-byte characters.

◆ ID No.

The File Name Display is linked to its function switch (File Name Key). Specify the number to identify this link is here. This number is available up to 255.

◆ File No.

Enter the file number registered in the Filing Data list (1 to 2047). The names under this number are displayed when the file is opened.

Reference *Tag Reference Manual, 4.2 Filing Data (Recipe) Function*

◆ By Way of LS

When Filing Data is transferred between backup SRAM and the PLC, it can be modified on the GP screen by routing it via the LS area (the data is stored temporarily in the LS area). If data transfer via the LS area is used, specify the LS area's start-word address where Filing Data will be stored from. The address where the data can be stored is from LS0020 to LS2031, and LS2096 to LS4095 (LS2096 to LS8191 for GP2000 series).

◆ PLC Transfer

This Bit is turned ON when filing data transfer to the PLC is completed. Since this Bit does not turned OFF automatically, to use the PLC Transfer Completed Bit again, turn it OFF beforehand.



When the PLC Transfer Completed Bit Address has been entered, in the case where filing data cannot be transferred to the PLC, the GP's special relay LS2032 Bit 10 will be turned ON.

■ File Name Display [Display] Attributes

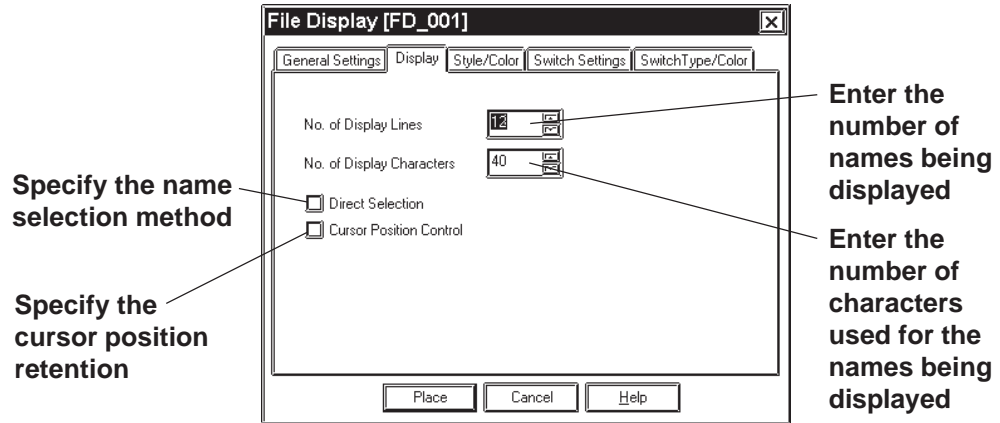

◆ No. of Display

Specify the number of Filing Data rows displayed on the GP. A maximum of 50 rows may be specified.

◆ No. of Display Characters

Specify the number of Filing Data characters used on each row. A maximum of 100 characters may be specified.

◆ Direct Selection

Select a File Name Display being placed on the GP by directly touching its border. If [Direct Selection] is not used, select the file name using the data scroll switches [Roll Up/Roll Down].

▼ Reference ■ File Name Display [Switch Settings] Attributes

◆ Cursor Position Control

Even when the screens are changed on the GP, the current screen's cursor position can be retained. When turning the GP's main power switch ON or resetting the GP, however, the cursor will appear in the first line.



Note: The cursor position will be stored for each ID No. To retain the cursor position, be sure that the File Name Display ID Nos. will not be overlapped through all the screens.

■ File Name Display [Style/Color] Attributes

Specify a color [display color (Fg)] for characters in the Filing Data display area, and a color [display color (Bg)] of the Filing Data display area.

▼ Reference 2.1 Parts ■ Selecting Colors

■ File Name Display [Switch Settings] Attributes

Set the function switches that are placed automatically.

▼ Reference ▲ 2.1.3 Function Switches

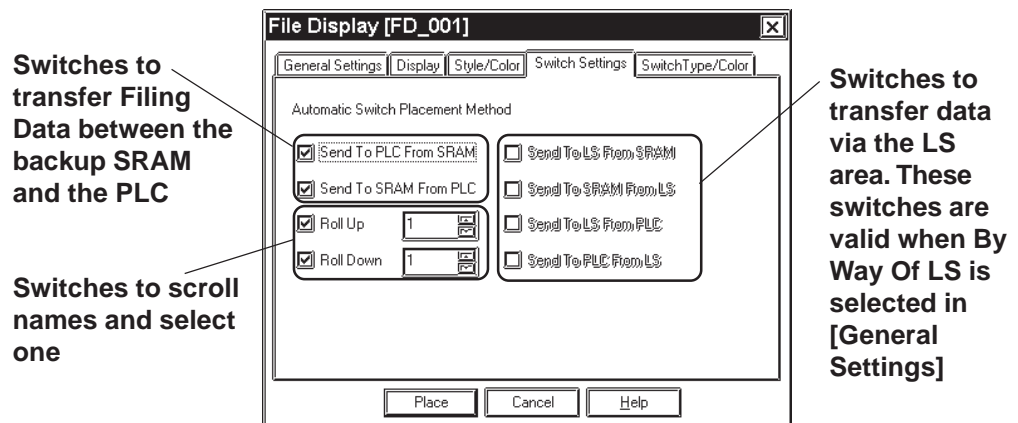

◆ Automatic Switch Placement Method

Automatically places the function switches for the selected names.

◆ Send To PLC From SRAM

Places the switch used to transfer Filing Data from the backup SRAM to the PLC.

◆ Send To SRAM From PLC

Places the switch used to transfer Filing Data from the PLC to the backup SRAM.

◆ Roll Up

Places the Roll Up key used to scroll names and select one. Touching the Roll Up key once will roll up names by the number specified here.

◆ Roll Down

Places the Roll Down key used to scroll names and select one. Touching the Roll Down key once will roll down names by the number specified here.

◆ Send To LS From SRAM

Places the switch used to transfer Filing Data from the backup SRAM to the LS area.

◆ Send To SRAM From LS

Places the switch used to transfer Filing Data from the LS area to the backup SRAM.

◆ Send To LS From PLC

Places the switch used to transfer Filing Data from the PLC to the LS area.

◆ Send To PLC From LS

Places the switch used to transfer Filing Data from the LS area to the PLC.

■ **File Name Display [Switch Type/Color] Attributes**

Specify colors (border colors) for the function switches which are placed automatically.

▼ **Reference** ▲ 2.1.3 Function Switches

■ **Place File Name Display**



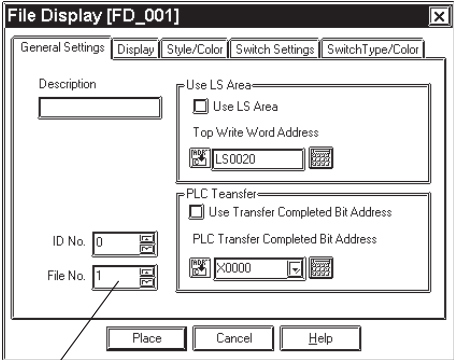

Shows how to call up the File Name Display.

~20°C	Registered File No. 1's filing data is displayed on the File Name Display with 3 display lines and 10 display characters. By pressing a function key (File Name Key), filing data can be transferred from the SRAM to the PLC, or from the PLC to the SRAM.
21~35°C	
36°C~	
SRAM →PLC	PLC → SRAM

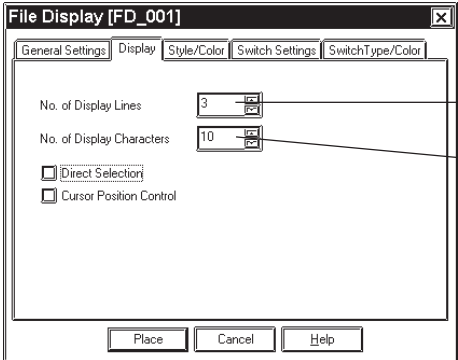
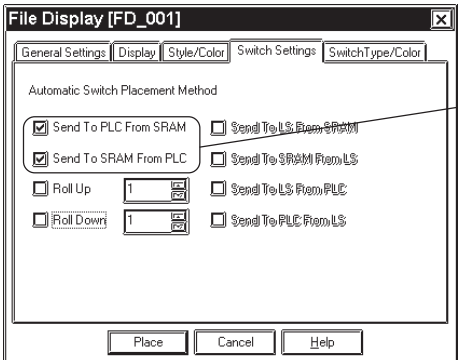
▼ **Reference** ▲ For filing data list and registering filing data, refer to *Tag Reference Manual, 4.2 Filing Data (Recipe) Function.*

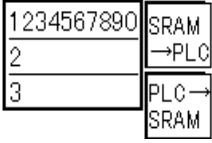
PROCEDURE	REMARKS
<p>(1) Select the [Parts] menu - [File Name Display] command, or click on the  icon.</p> <p>(2) In the [General Settings] tab, enter the File No. of filing data to be transferred and the File Name Display's ID No. Here, since File No. 1's data is transferred, enter "1" for the file number. The File Name Display's ID No. is "0".</p>  <p>Enter 1</p>	<p>▼ Reference ▲ ■ <i>File Name Display [General Settings] Attributes</i></p> <p>To transfer Filing Data via the LS area, mark the check box for [Use LS Area] in the [Use LS Area].</p>

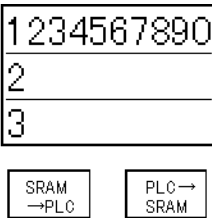
PROCEDURE	REMARKS
<p>(3) In the [Display] tab, specify the No. of Display Lines, Display Characters, Direct Selection, and Cursor Position Control.</p> <p>If necessary, specify the display color in the [Style/Color] tab.</p>  <p>Enter 3</p> <p>Enter 10</p> <p>(4) In the [Switch Settings] tab, select the function switches which are being placed automatically, and specify the number of lines being rolled up or down.</p>  <p>Select these two switches</p> <p>(5) Specify the border colors for the function switches in the [Switch Type/Color] tab.</p> <p>(6) After setting all the attributes, click on <input type="button" value="Place"/>.</p> <p>The frame of the File Name Display size will be displayed in the drawing area.</p>	

PROCEDURE	REMARKS
<p>(7) Click the mouse button where you want to place each attribute.</p>  <p>(8) Select the placed File Name Display. Then, select the [Edit] menu - [Ungroup] command, or click on the  icon to ungroup the File Name Display and alter each item's position and size.</p> 	<p>To cancel the placement, click on the  icon.</p> <p>The File Name Displays are grouped. To change any attribute, first ungroup the File Name Displays, and then change the attribute.</p> <p>Reference 2.4.12 <i>Group/Ungroup</i></p> <p>Reference 2.4.14 <i>Changing Attributes</i></p> <p>If the By Way Of LS area is selected, the address for the LS area can be changed after ungrouping the File Name Displays.</p>

2.1.17 Data Logging Display

Data created in the data logging settings can be displayed and edited on the GP unit.



- **After the data logging settings, place the Data Logging Display.**

Reference For registering logged data, refer to *Tag Reference Manual; 4.3 Logging Function*

- **The Data Logging Display does not operate in a window.**



- Only one Data Logging Display can be placed on each screen.
- The Data Logging Display cannot be set simultaneously with any K-tag or Keypad Input Display.
- Data that could not be logged due to a read error is identified with “***” in a cell.
- Data that is not logged is not displayed.

■ Data Logging Display [General Settings] Attributes

Enter a comment, if necessary

Specify whether the data edit function is enabled or disabled

Specify whether the interlock function is enabled or disabled

Using a word address, specify the block number of data being displayed

Using a bit address, specify the interlock address

◆ Block Number Address

On a block basis, specify the data being displayed. The logged data for the block number stored at the word address specified here will be displayed.

The block numbers that can be entered are between 0 and 2047, but the maximum of the effective range is [Number of Blocks] specified in [Trigger Settings] in the data logging settings. If [Number of Blocks] specified in [Trigger Settings] is 4, the block numbers are 0 to 3 (BIN values only).



- If any block number that does not exist is specified, no data will be displayed.
- When the loop function has been designated via [Trigger Settings] of the data logging settings, the Block Number Address will become ineffective.

◆ Data Edit

The logged data can be modified by directly touching the frame of each item in the Data Logging Display placed on the GP. If Data Edit is enabled, touching the cell of data that can be modified in the table will cause the buzzer to sound and allow you to enter data. If Data Edit is disabled, this touching will be invalid and the buzzer will not sound.

- The data that can be modified is only [Date] and [Value] that have been logged.



Note: If a block or logged data is selected by changing the block number during on-screen modification of data, the data edit mode is canceled.

- If the cell is moved beyond the display area, using the scroll keys during the data edit mode, the data edit mode is canceled.

◆ Interlock

The interlock can only be activated when the data edit capability is enabled. If the interlock is enabled, data can be modified only when the bit address for the interlock is ON. If the interlock is disabled, data can always be modified by touching it.



Note: If the bit address for the interlock is turned OFF during on-screen modification of data, the data edit mode is canceled.

■ Data Logging Display [Data Type] Attributes

Select a Border Type of the display area



Specify whether the scrolling of the totaling section is enabled or disabled

Enter the number of rows for the items displayed (0 to 40)

Enter the number of columns for the items displayed (0 to 25)

Enter a display interval (the number of dots) (0 to 10)

◆ Border Type

Select a border type of the display area from among three types, No Border, outer border  (1-dot lines), and outer border plus inner border  (the outer border and item use 2-dot lines, while the inner border uses 1-dot lines).

◆ Row

Specify the number of rows used to display logged data on the GP. A maximum of 40 rows may be specified.

◆ **Column**

Specify the number of columns used to display logged data on the GP. A maximum of 25 columns may be specified.

◆ **Spacing**

Specify spacing at which to display logged data on the GP. A maximum of 10 dots may be specified. This entry is only valid when the display area border type is specified as No. Border. Draw the border line using the drawing tool.



The gap equivalent to the specified display spacing is provided between the cell and the border line. The entire cell is filled with the clear color specified in the Data Logging Display [Color] Attributes. However, the gap is not displayed in the clear color, but its background is displayed. If No Border is selected to draw an arbitrary border, ensure that the border is drawn using the same width as the specified display interval without overlapping the cell.

<Display Spacing>

◆ **Scroll data area**

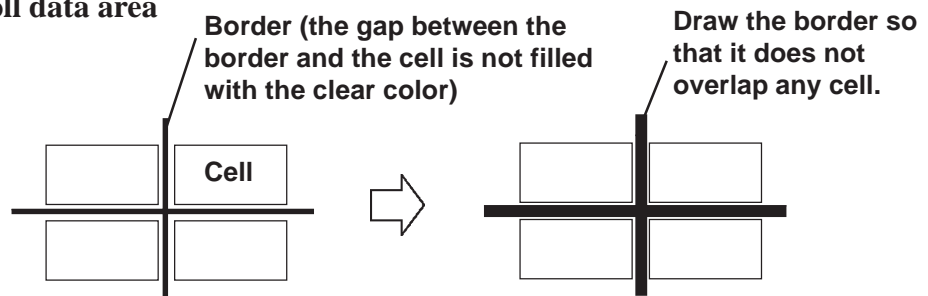

If the scroll data area is enabled, the totaling section is scrolled together with the data section. If the totaling section scroll is disabled, the totaling section always appears on the screen.

■ **Data Logging Display [Color] Attributes**

Select a color (clear color) displayed when the border of each item is cleared. **Reference** 2.1 Parts ■ *Selecting Colors*

■ Data Logging Display [Switch Settings] Attributes

The number of rows and that of columns specified in [Data type] are displayed on the Data Logging Display. If any data exceeding these numbers exists in the GP, use the function switches to scroll the data.

▼ Reference ▲ 2.1.3 Function Switches

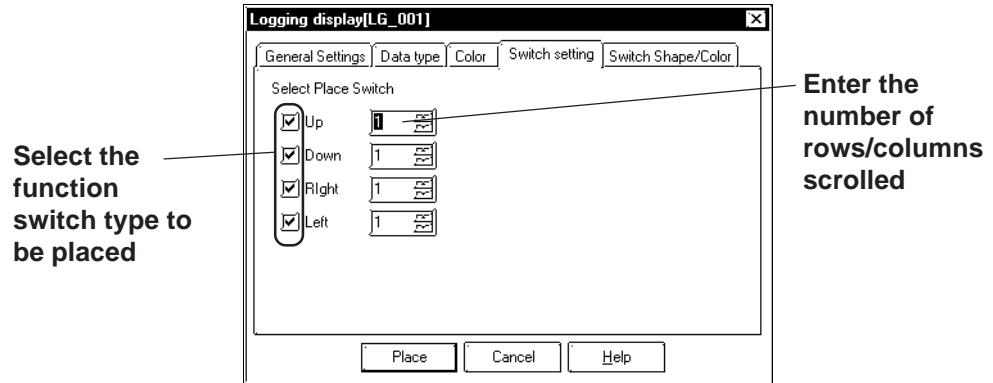

■ Data Logging Display [Switch Shape/Color] Attributes

Specify a color (border color) of each function switch.

▼ Reference ▲ 2.1 Parts ■ Selecting Colors

■ **Placing the Data Logging Display**

The procedure for setting the Data Logging Display is described below:

The logged data for the block number stored at the block number designated address is displayed.

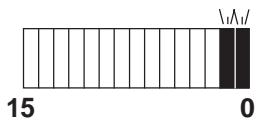

If 3 is stored at D0100.



	Date	Time	Data1	
1st	98/10/16	09:14:00	144	LP
2nd	98/10/16	09:14:00	145	EM
3rd	98/10/16	09:14:01	146	
4th	98/10/16	09:14:01	147	R
5th	98/10/16	09:14:01	148	
TOTAL			730	L

The logged data in block No. 3 will be displayed.

PROCEDURE	REMARKS
-----------	---------

(1) Select the [Parts] menu - [Data Logging Display] command, or click on the icon.

(2) In the [General Settings] tab, specify the block number designated address, data edit, and whether the interlock is enabled or disabled.
Specify D0100 for the block number designated address.

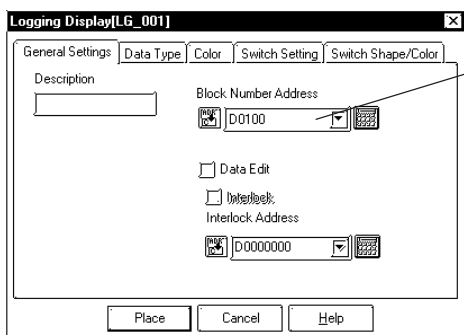

Enter D0100





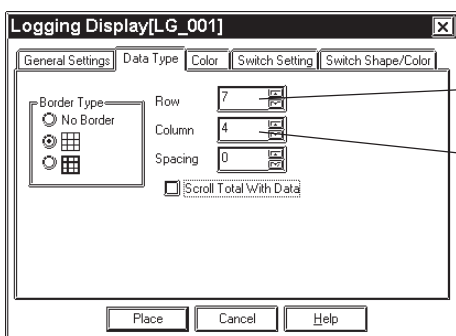

Reference 2.1.17 ■ *Data Logging Display [General Settings] Attributes* ◆ *Block Number Address*

(3) In the [Data Type] tab, specify the display settings.
If necessary, select a clear color in the [Color] tab.

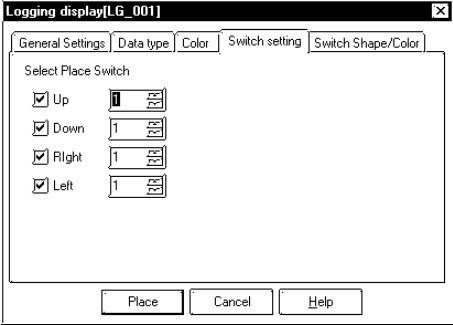

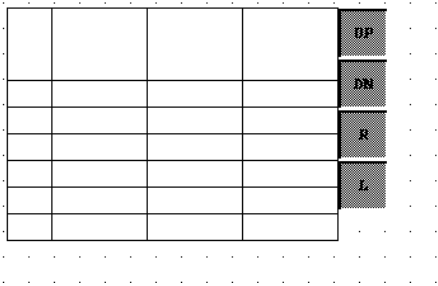
Enter 7

Enter 4

PROCEDURE	REMARKS
<p>(4) In the [Switch Settings] tab, select the function switch type that is to be placed automatically, and specify the number of rows, columns scrolled.</p> <p>If necessary, select a color for the special switch in the [Switch Shape/Color] tab.</p>  <p>(5) After entering and selecting all the attributes, click on the  button.</p> <p>The border of the Data Logging Display size will be displayed in the drawing area.</p> <p>(6) Click on the point where the function switch is to be placed.</p> 	<p>To cancel the placement, click on the  icon.</p> <p>The Data Logging Displays are grouped. To change any attribute, ungroup the Data Logging Displays by clicking on the  icon beforehand.</p> <p>Reference  2.4.12 <i>Group/Ungroup</i></p> <p>If you double-click on the function switch placed on the screen, the address confirmation screen for parts will appear, enabling you to change the address.</p> <p>Reference  2.4.14 <i>Changing Attributes</i></p>

2.1.18 Numeric Displays

This Part displays host Word Address numeric data as an absolute value.

■ Numeric Display [General Settings] Attributes

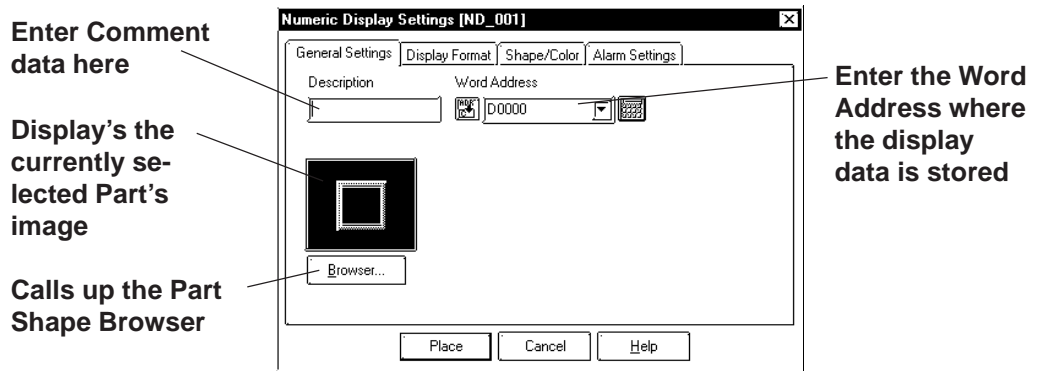

◆ Word Address

Here, input the Word Address where the display data is to be stored.

■ Numeric Display [Display Format] Attributes

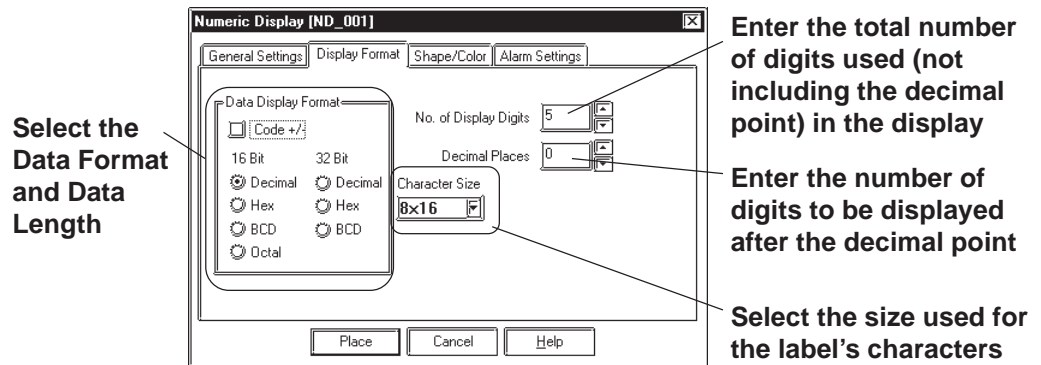

◆ Data Display Format

Here, the Data Display Format, Code, and data length are selected. Choose a data format of either Decimal (base 10), BCD, Hexadecimal (base 16), or Octal (base 8). With the Code +/- check box checked, when you select “Decimal”, negative numeric data can also be displayed.

◆ No. of Display Digits

Here, enter the total number of digits used (not including the decimal point) in the display.

Note: When the No. of Display Digits is set to 5 and the Decimal Places is set to 2, a value appears on the Numeric Display as shown below.

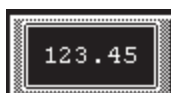

◆ Decimal Places

Here, enter the number of digits to be displayed after the decimal point

The types of numeric data that can be used with each data format are listed below.

Data Form	Code	Data Length	No. of Display Digits	Decimal Places	Alarm Range	
Dec	+/-	16 bit	1-5	0-4	+ only	0-65535
					+/-	-32768-32767
		32 bit	1-10	0-9	+ only	0-4294967295
					+/-	-2147483648-2147483647
BCD	+	16 bit	1-4	0-3	0-9999	
		32 bit	1-8	0-7	0-99999999	
Hex	+	16 bit	1-4	/	0-FFFF	
		32 bit	1-8		0-FFFFFFFF	
Oct	+	16 bit only	1-6		0-17777	

The relationship between upper and lower position Word Addresses when 32 bit data is used will differ depending on each Device/PLC Type.

▼ **Reference** ▲ *Device/PLC Connection Manual*

◆ Character Size

The label's Character Size is selected here.

▼ **Reference** ▲ *2.2.9 Text*



Note: Only when the GP type is the GP-77R, GP-377R, or GP2000 series, is the 8 x 16 setting valid. For any GP other than the GP-77R, GP-377R or GP2000 series, selecting 8 x 16 in the editor will display 16 x 16 on the GP.

■ Numeric Display [Shape/Color] Attributes

Here, the Numeric Display area's border color, value display color (Number color), and interior color (Plate color) are selected.

▼ **Reference** ▲ *2.1 Parts* ■ *Selecting Colors*

■ Numeric Display [Alarm Settings] Attributes

If desired, specify a variety of Alarm settings.



▼ **Reference** ▲ *2.1 Parts* ■ *Alarm Settings*

■ **Placing a Numeric Display**

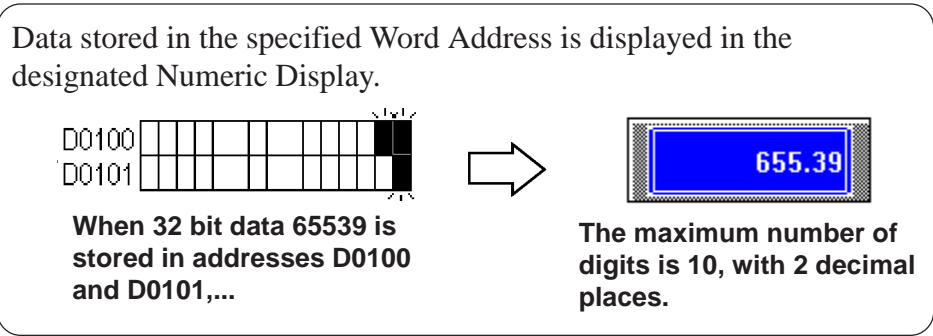
The procedure for placing a Numeric Display is shown below.

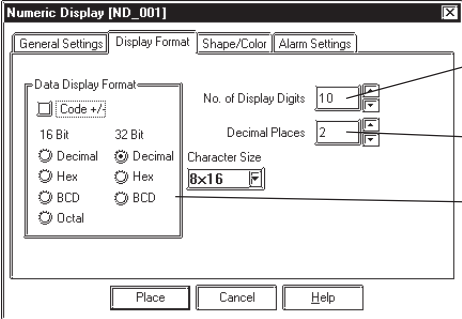

PROCEDURE	REMARKS
<p>(1) Select the [Parts] menu - [Numeric Display] command, or click on the icon.</p> <p>(2) In the [General Settings] tab, input the Word Address used to store the display data.</p> <p>(3) Select a Part Shape from the Browser. If desired, set an Alarm and Colors from the [Alarm Settings] and [Shape/Color] area.</p>	<p>Reference 2.1 Parts ■ <i>Selecting a Part Shape</i></p>

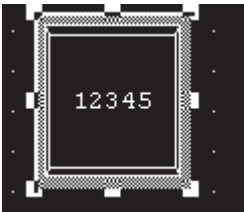
PROCEDURE	REMARKS
<p>(4) In the [Display Format] area, specify the Data Display Format, and input the No. of Display Digits and the Decimal Places. Specify the Character Size, if desired.</p>  <p>Enter 10</p> <p>Enter 2</p> <p>Select 32 bit Decimal</p>	
<p>(5) After all of the Part's attributes have been entered and selected, click on the <input type="button" value="Place"/> button. The Numeric Display's outline will appear on the Base screen, next to your cursor.</p>	
<p>(6) Click on the point where the Numeric Display's top left corner is to be placed. If necessary, use the Numeric Display's handles to alter its size after placement. Regardless of whether the numeric data display area is scaled up or down, the character size will not change. To change the character size and position, select the characters inside the border directly.</p>	<p>To cancel the placement, click on the  icon.</p> <p>Reference To change a Part's size, refer to <i>2.4.3 Scaling Up/Down</i></p>
	<p>Pressing the <input type="button" value="Ctrl"/> key while re-sizing an area's border will also re-size that area's characters.</p> <p>Double-clicking on any Part placed on the screen automatically calls up that Part's attribute settings.</p> <p>Reference <i>2.4.14 Changing Attributes</i></p>

2.1.19 Message Display

This display is used to show single-line alarm messages in response to changes in PLC Word Address data. A total of 16 messages can be displayed, in order of occurrence, in a message display area.

■ Message Display [General Settings] Attributes

The screenshot shows the 'Message Display Settings [MW_001]' dialog box. It has two tabs: 'General Settings' and 'Messages'. The 'Messages' tab is active, showing fields for 'Description', 'Address' (set to 'D0000'), 'Border Color' (with a color palette and a 'Blk' checkbox), 'Alignment' (with three icons for left, center, and right), 'Character Size' (set to '8x8'), and 'Mode' (with 'Bit' and 'Word' radio buttons). A 'Browser...' button is next to the 'Description' field. At the bottom are 'Place', 'Cancel', and 'Help' buttons. Annotations with arrows point to various elements: 'Enter Comment data here' points to the 'Description' field; 'The currently selected Part Shape is displayed here' points to a square icon in the 'Description' field; 'Calls up the Part Shape Browser; Part Shapes can be selected directly from the Browser' points to the 'Browser...' button; 'Select the Word or Bit Address to be monitored' points to the 'Address' field; 'Select a Border color' points to the 'Border Color' section; 'Select the type of alignment desired for the text of the Display' points to the 'Alignment' section; 'Select a Character Size' points to the 'Character Size' field; and 'Select the Operation Mode' points to the 'Mode' section.

◆ Address

Enter an Address to be monitored. Select either Bit Address or Word Address according to (operation) Mode.

◆ Border Color

The Message Display's Border color can be selected.

Reference [2.1 Parts](#) ■ *Selecting Colors*

◆ Alignment

Here, the text's alignment can be selected.



◆ Mode

There are two methods to change messages displayed on the Message Display, i.e. via Bit's turning ON/OFF and Word state changes. Here, select either mode.

Mode: When selecting Bit

Messages will change according to the specified Bit Address changes.

Mode: When selecting Word

Messages will change according to the state changes of the designated bits, consecutively from the specified Address's 00 bit.

According to the number of the messages (either 2, 4, 8, or 16), a bit is automatically assigned from the specified Address's 00 bit.

Numbers of Messages	Number of Bits Used
2	1
4	2
8	3
16	4

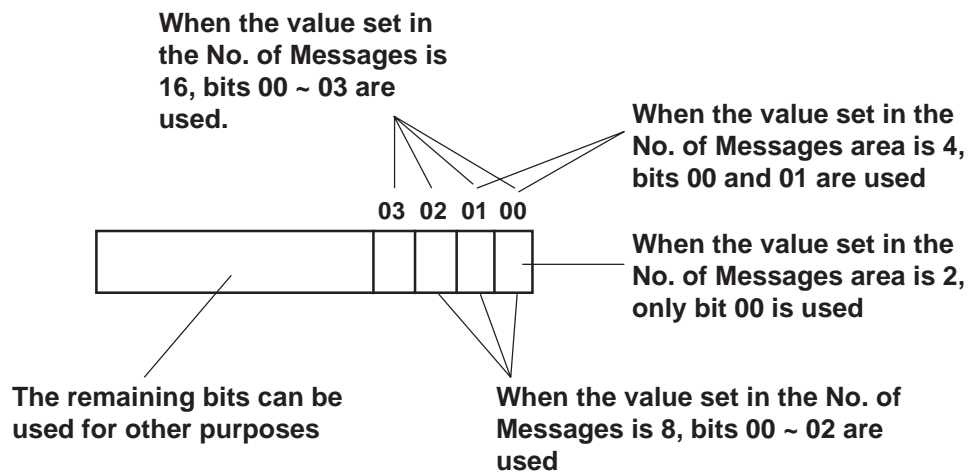

■ Message Display [Messages] Attributes

(Operation Mode example: When using Word Address)

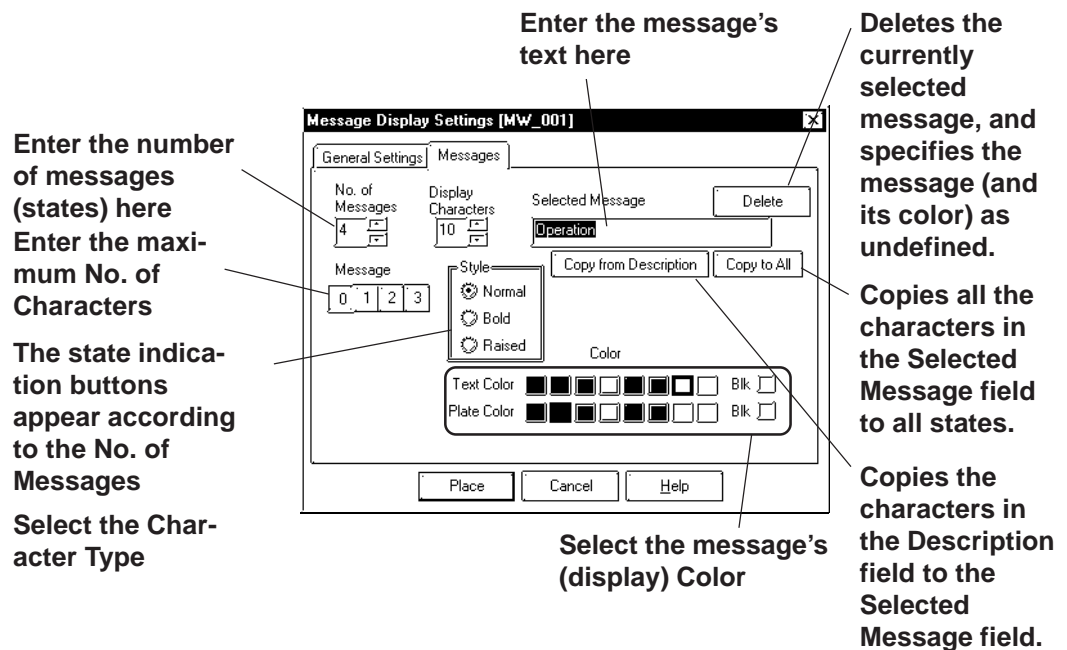

◆ No. of Messages

The number of the messages (number of states) can be selected from 2, 4, 8, and 16.

◆ Display Characters

Here, the maximum number of characters displayed in a message is selected. Up to 40 characters can be input. If the number of a message characters exceeds the specified value, characters that do not fit in the area will be truncated.

◆ Message

According to the No. of Messages, designate a message for each state.

Operation Mode: Bit Off On

Designate a message for each state (ON and OFF).

Operation Mode: Word 0 1 2 3

As many buttons as the number of the specified messages will be displayed. Designate a message for each state.

◆ Selected Message

Messages are entered here. After entering a message, the message will be displayed in the selected color(s). The default value setting is "Undefined".

◆ Color

Here, each message's display colors can be selected.

Default settings are = Char. color - White; Plate (background) color - Blue.

■ **Placing a Message Display**

The Message Display setting procedure is shown below. (When using a Word Address)

<p>Message No. 0: None Message No. 1: Signal A Operation Message No. 2: Signal B Operation Message No. 3: Signal A & B Operation</p> <p>A message from those listed above, allocated to the specified Word Address...</p>	
	<p>...displays in response to changes in the Word Address data.</p>

PROCEDURE	REMARKS
-----------	---------

(1) Select the [Parts] menu - [Message Display] command, or click on the  icon.

(2) In the [General Settings] tab, input a Word Address. Select the message's Border Color, Text Alignment and Character Size, if desired.

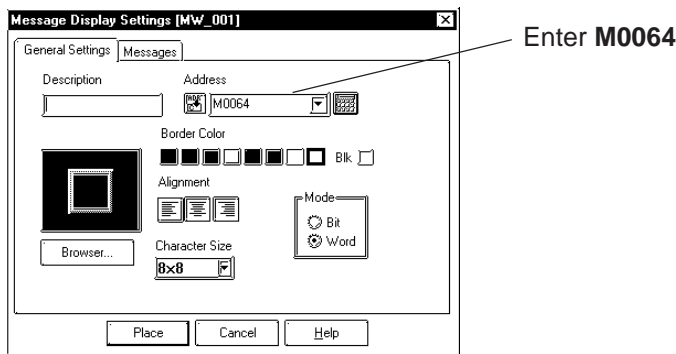

(3) Select a Part Shape from the Browser.

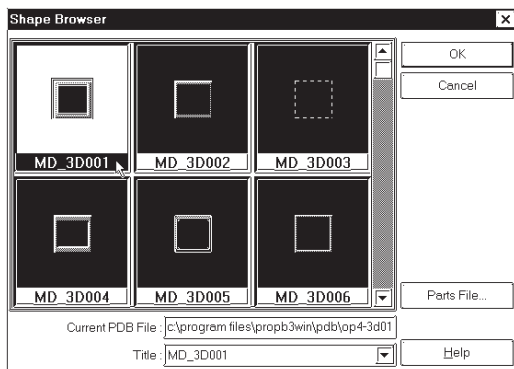

Reference 2.1 Parts ■ *Selecting a Part Shape*

PROCEDURE	REMARKS
-----------	---------

(4) In the [Messages] area, input the number of the messages and characters used.

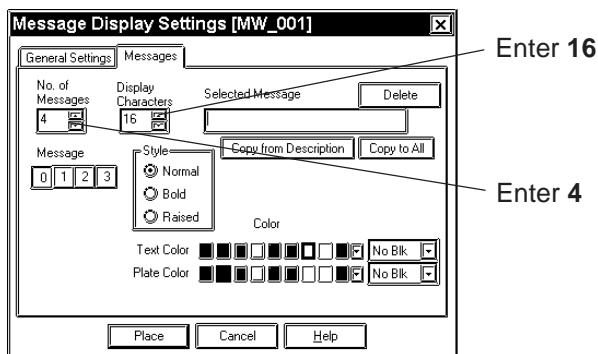

(5) Enter your Alarm Messages.

Select the message number to be registered and enter the message. When displaying a border with no message, be sure to delete the words “Undefined”. Select Colors and Character Size, if necessary.

(Example) When registering the message “A Unit Operating” as message Number 1:

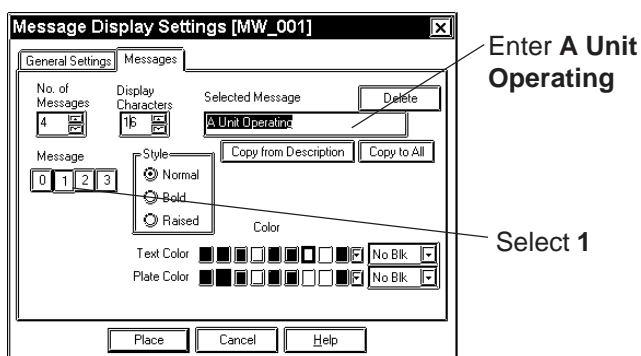

(6) After all of the Part’s attributes have been entered and selected, click on the Place button.



The Message Display’s outline will appear on the Base screen, next to your cursor.



Important

Any characters entered that are over the limit specified in step (4) will be cut from the GP’s display.

If the text “Undefined” is not deleted, it will be registered and then displayed as a message.

PROCEDURE	REMARKS
<p>(7)Click on the point where the Message Display's top left corner is to be placed on the Base Screen. If necessary, use the Message Display's handles to alter its size after placement. The message, corresponding to the message number designated in the Dialog box, is displayed on the Message Display. Regardless of whether the Message Display is scaled up or down, the character size will not change. To change the character size and position, directly select a character inside the text box.</p> 	<p>To cancel the placement, click on the  icon.</p> <p>To change the Part's size, refer to Reference 2.4.3 <i>Scaling Up/Down</i></p> <p>When the Message Display is scaled up(larger), the message characters may not be displayed in the correct position. In that case, use the pull down menu [Edit] menu's [Align...] command to adjust the position. Reference 2.4.9 <i>Align</i></p> <p>Double-clicking on any Part placed on the screen automatically calls up that Part's Attribute Settings dialog box. Also, clicking on the message numbers allows you to view the message's display status. Reference 2.4.14 <i>Changing Attributes</i></p>



- Changing the state via the Parts State Change Tool Bar after placing a Part allows you to check each state's Library display condition.
- Every time a part's screen is opened, the Part's state will be reset to 0.
- If a state which has not been defined is designated, the Message Display may show nothing. For example, when the number of messages is 16 and only states 0 to 3 actually have a message registered, designating states 4 to 15 displays only message frames.

2.1.20 Date Displays

Date display data is created using the GP's internal calendar and formatted as;

February 11th, 2001, or 01/02/11; however, the date format can be changed.

■ Date Display [General Settings] Attributes

Enter Comment data here

The currently selected Part's image is displayed here

Calls up the Part Shape Browser. Parts can be selected directly from the Browser

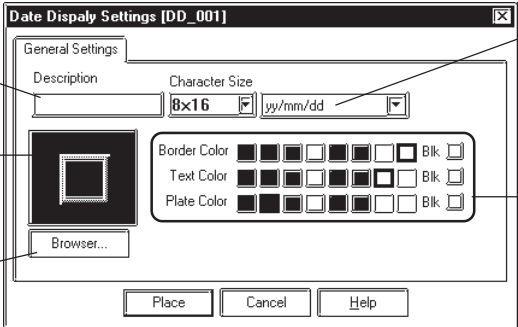

Select the Data Format

Select the Border (frame), Text and Plate (background) colors

◆ Data Format

The following display formats are available:

yy/mm/dd
 dd/mm/yy
 mm/dd/yy
 20yy/mm/dd*¹
 dd/mm/20yy*¹
 mm/dd/20yy*¹

(yy: year, mm: month, dd: day)

◆ Color

The Date Display's border color, character display color (Text), and interior color (Plate) can be selected here.

Reference 2.1 Parts ■ *Selecting Colors*

◆ Character Size

The label's Character Size is selected here.

Reference 2.2.9 *Text*

*1 The characters used for the display of 2000's first two characters ("20") are single-byte characters.

■ **Placing a Date Display**

The Date Display placement procedure is shown below.



PROCEDURE	REMARKS
-----------	---------

- (1) Select the [Parts] menu - [Date Display] command, or click on the  icon.
- (2) In the [General Settings] area, select a display format.

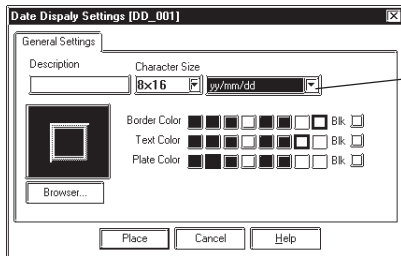

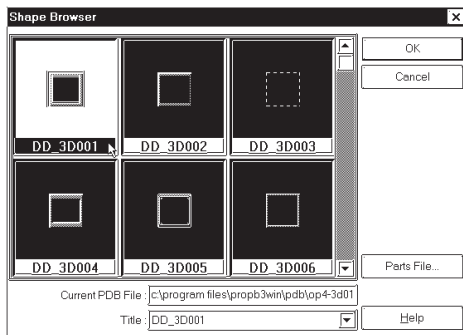

Select the **yy/mm/dd** format

- (3) Select a Part Shape from the Browser.
If desired, select Colors and Character Size.



▼ **Reference** 2.1 Parts ■ *Selecting a Part Shape*

- (4) After all of the Part's attributes have been entered and selected, click on the [Place] button.
The Date Display's outline will appear in the Base screen, next to your cursor.

PROCEDURE	REMARKS
<p>(5) Click on the point where the Date Display's top left corner is to be placed.</p> <p>If desired, use the Date Display's handles to alter its size. Regardless of whether the Date Display is scaled up or down, the character size will not change. To change the character size and position, directly select the characters inside the border.</p> 	<p>To cancel the placement, click on the  icon.</p> <p>To change a Part's size, refer to Reference 2.4.3 Scaling Up/Down</p> <p>Double-clicking on any Part placed on the screen automatically calls up that Part's attribute settings.</p> <p>Reference 2.4.14 Changing Attributes</p> <p>When scaling up or down the display area, if the  key is pressed at the same time, the characters will scale in unison with the border.</p>

2.1.21 Time Displays

Time Display areas can be created, based on the GP's internal calendar function. Time will be expressed in 24 hour format.

(E.g.) 2:25 pm > 14:25

Only one Time Display Part can be used per screen.

■ Time Display [General Settings] Attributes

Enter Comment data here

The currently selected item's image appears here

Calls up the Part Shape Browser. Part Shapes can be selected directly from the Browser

Select the Character Size

Select Border, Character, and Plate colors

◆ Color





Here, the Time Display's Border color, character display color (Text), and background color (Plate) can each be selected.

▼ **Reference** ▲ 2.1 Parts ■ *Selecting Colors*

■ **Placing a Time Display**

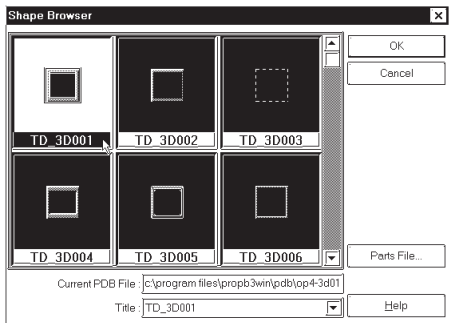
The Time Display is placed using the following procedure.

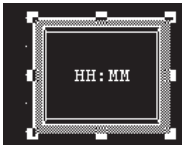

PROCEDURE	REMARKS
<p>(1) Select the [Parts] menu - [Time Display] command, or click on the  icon.</p> <p>(2) Select a Part Shape from the Browser. If desired, select Colors and Character Size.</p>  <p>(3) After all of the Part's attributes have been entered and selected, click on the  button. The Time Display Part's outline will appear on the Base screen, next to your cursor.</p> <p>(4) Click on the point where the Time Display's top left corner is to be placed. Change the size if necessary. Regardless of whether the Time Display is scaled up or down, the character size will not change. To change the character size and position, select the characters directly.</p> 	<p>Reference 2.1 Parts ■ <i>Selecting a Part Shape</i></p> <p>To cancel the placement, click on the  icon.</p> <p>Reference To change a Part's size, refer to 2.4.3 <i>Scaling Up/Down</i></p> <p>When scaling up or down the display area, if the  key is pressed simultaneously, the characters are also scaled up or down together with the border.</p> <p>Double-clicking on any Part placed on the screen automatically calls up that Part's attribute settings.</p> <p>Reference 2.4.14 <i>Changing Attributes</i></p>

2.1.22 Picture Displays

Registered Library items are displayed according to PLC Word Address changes. Parts and Tags, however, cannot be displayed in these displays. Up to 16 different kinds of Library items can be displayed on a single Picture Display.

Reference 2.5 Libraries



The Picture Displays will not be displayed on the GP when transferred, if the GP has not been connected to the PLC yet.

Picture Display [Description] Attributes.

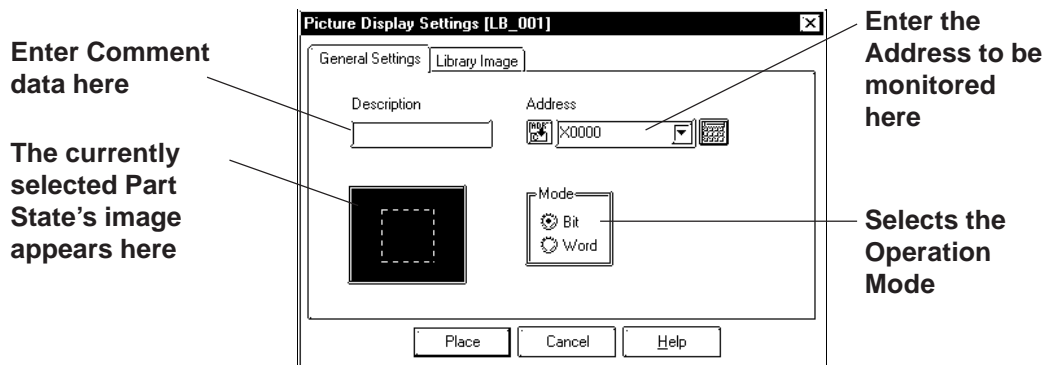

◆ Address

Here, either a Bit or Word Address is entered, after first selecting a Type (either Bit or Word).

◆ Mode

There are two methods used to switch the Library images displayed on the Picture Display; one is Bit access and the other is Word access. Select either of these.

Mode: When selecting Bit

Messages will change according to the specified Bit Address changes.

Mode: When selecting Word

Messages will change according to the state changes of the designated bits, consecutively from the specified Address's 00 bit.

According to the number of the messages (either 2, 4, 8, or 16), a bit is automatically assigned from the specified Address's 00 bit.

Numbers of Messages	Number of Bits Used
2	1
4	2
8	3
16	4

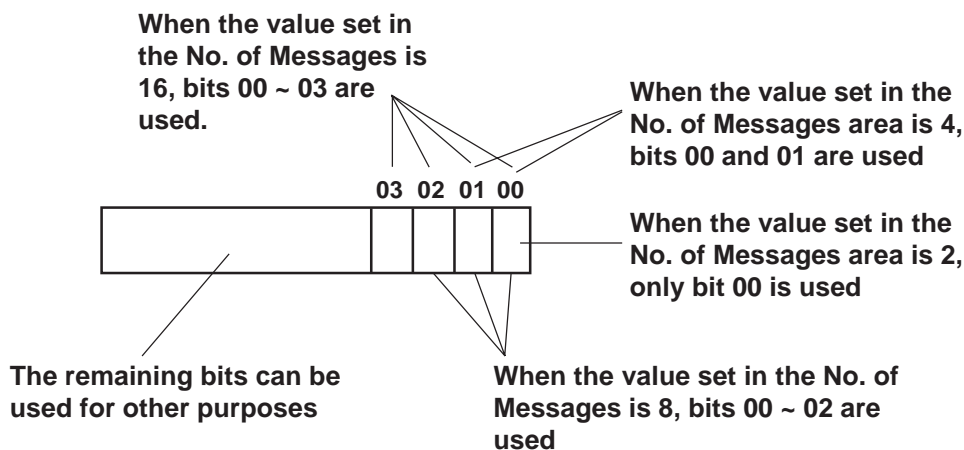

■ **Picture Display [Library Image] Attributes**

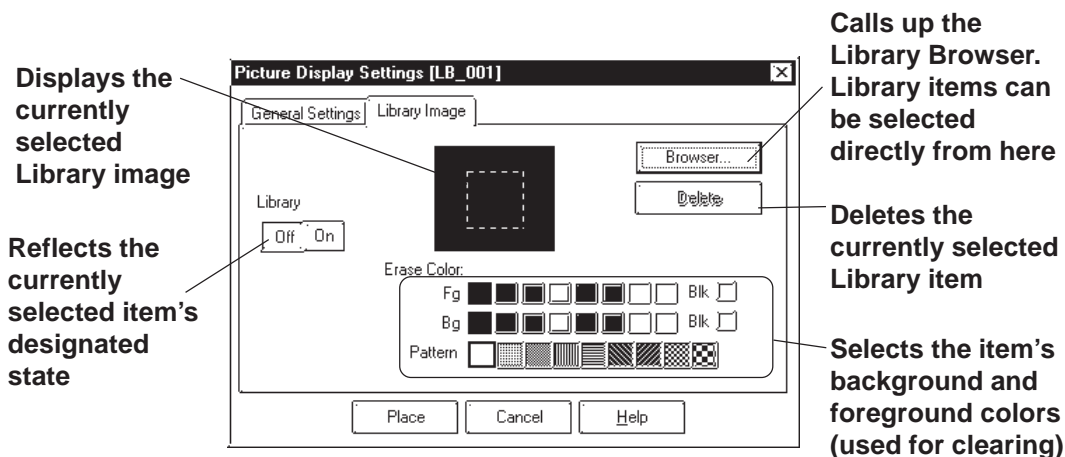

◆ **Browser**

When clicking on the button, the Library Browser (Library list) will appear. Select a desired Library from this list and drag it to the inside of the Library image display border on the Dialog box.

▼ **Reference** 2.5 Libraries

◆ **Delete**

The selected Library item is deleted and the display will disappear.

◆ **No. of Lib.**

Displays only when Type's Word is selected. The number of Library images (number of states) to be displayed on the Picture Display can then be input. Select any of 2, 4, 8, or 16.

◆ **Library**

Here, the Library item used for each state is specified. Settings will differ depending on the Type selection.

Mode: When selecting Bit

Specify a Library item's ON and OFF states, respectively.

Mode: When selecting Word

The number of buttons will match the designated number of Library items. Specify a Library item for each state.



Changing the state via the Parts State Change Tool Bar after placing a Part allows you to check each state's Library display condition.

◆ **Color**

The background square colors (Clear Fg, Clear Bg) and pattern (Pattern) are selected. The default settings are black. The square colors can be selected so as to match the Picture Display placement area background's color.

<Back Ground Square>

The Library item to be displayed while the GP is running needs the filled square for the background to be the rearmost, so that the items(images) do not overlay each other when they are switched. When designating a Library item, the GP-PRO/PBIII for Windows program will draw this colored square automatically.

Right after the Library item(s) is/are placed, the background square will match the size of the largest Library item designated. After the items are placed, it can be scaled larger or smaller, independently from the Library items.



For a state with no designated Library item, only a background square will be displayed and it will become the Library's deletion screen, i.e. it will be overlaid on top of an existing item to "delete" that item.

■ **Placing a Picture Display**

The Picture Display's creation procedure is shown below.

The 3 pictures registered as libraries, as illustrated above, will change in response to changes in the state of Word Address D00250.

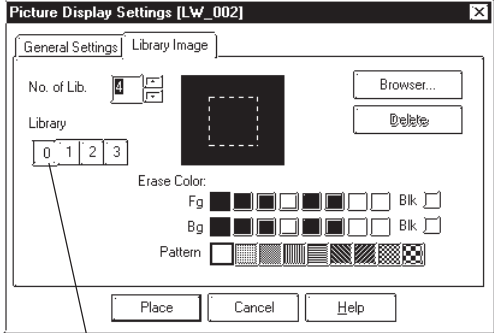
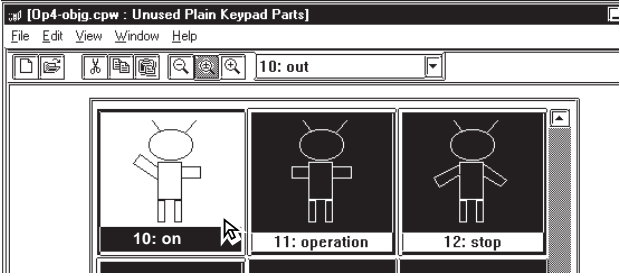
PROCEDURE	REMARKS
<p>(1) Select the [Parts] menu - [Picture Display] command, or click on the icon.</p> <p>(2) In the [General Settings] area, enter an Address and select a Mode.</p> <p>(3) In the [Library Image] area, input the No. of library items (No. of Lib.) used.</p>	

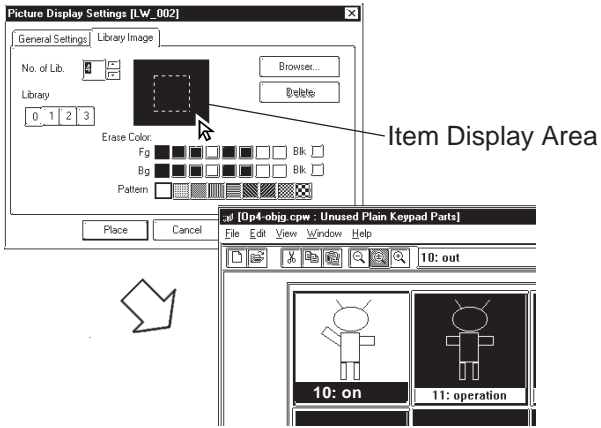
PROCEDURE	REMARKS
<p>(4) Select a state (to register an item as), and then click on the  button. Here, perform settings for state 0.</p>  <p>Select 0</p> <p>(5) Select a Library to be displayed for state 0 from the Browser.</p>  <p>(6) Drag the selected item to the Dialog box's black item display area. Select foreground or background Colors, if desired.</p> 	<p>Reference 2.5 Libraries</p> <p>To select a Library from a file different from the currently displayed one, click on the Library Browser's  icon.</p> <p>Reference 2.5 Libraries</p>

PROCEDURE	REMARKS
<div data-bbox="395 235 464 297" style="text-align: center;">↓</div> <div data-bbox="250 313 663 593"> </div> <p data-bbox="204 616 949 734">(7) For States 1 and 2, repeat steps (4) ~ (7). Since State 3 is used to delete Library item from the screen, nothing is specified for it.</p> <p data-bbox="204 779 949 936">(8) After all of the item's attributes have been entered and selected, click on the Place button. The Picture Display's outline will appear on the Base screen, next to your cursor.</p> <p data-bbox="204 981 949 1429">(9) Click on the point where the Picture Display's top left corner is to be placed. Here, the Picture Display's border (dotted line or filled square) and the Library item will appear. At this time, the Library item corresponding to the state currently selected in the Dialog box is displayed on the Picture Display. Regardless of whether the Picture Display's border is scaled up or down, the Library item's size will not change. The border size is common through all the Libraries. The Library item's size and position can be altered by clicking directly on its inside border.</p> <div data-bbox="250 1467 502 1680" style="text-align: center;"> </div>	<p data-bbox="997 616 1436 694">To delete a Library item, click on the Delete button.</p> <p data-bbox="997 981 1436 1059">To cancel the placement, click on the  icon.</p> <p data-bbox="997 1131 1436 1317">Double-clicking on any Part placed on the screen automatically calls up that Part's attribute settings. Also, switching the states allows you to view the Library display status.</p> <p data-bbox="997 1321 1436 1400">▼ Reference ▼ 2.4.14 Changing Attributes</p> <p data-bbox="997 1467 1436 1624">Changing the state via the Parts State Change Tool Bar after placing a Part allows you to check each state's Library display condition.</p>



- Every time the screen is opened, the state will be reset to 0.
- If a state with no Library registered is designated, nothing will be displayed on the Picture Display. For example, when the number of messages is 16 and only states 0 to 3 actually have a message registered, designating states 4 to 15 displays only background square frames.

2.1.23 Window Parts

Calls up the window onto the Base Screen (B). Register the windows to the Window Registration via the Window Screen (U). This operation is easier than using the U-tag.

■ Window Parts Attributes

Enter comment data here.

This displays the Window Number of the window registered on the Window Screen (U).

Select the Window Number you want to call up onto the Base Screen (B).

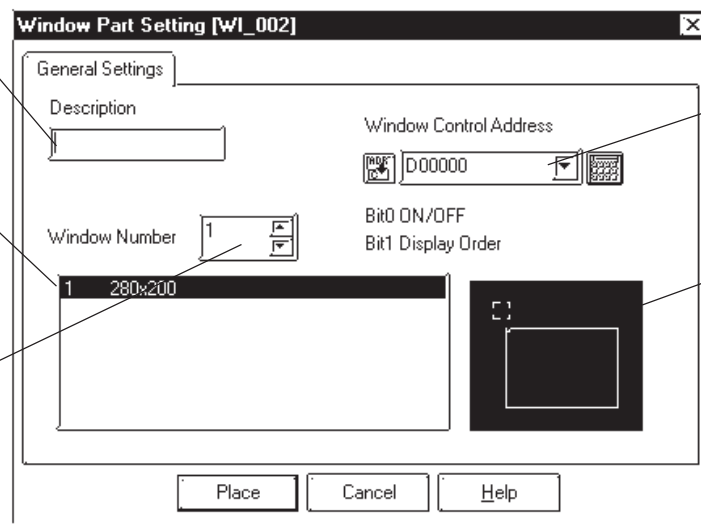

Specify the Window Control Address.

Preview the window associated with the selected Window Number in this area.

◆ Window Control Address

Enter the address to control the Hide/Show status of the windows.

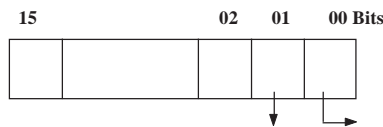

Changing the order of window layer

Show [0]: Hide the window
[1]: Show the window

[0]: Touching the window will change the order of the layer.



[1]: Touching the window will NOT change the order of the layer.

Reference 3.7.1 Overview of Window Display, 3.7.2 Window Registration on the U Screen

■ **Placing Window Parts**

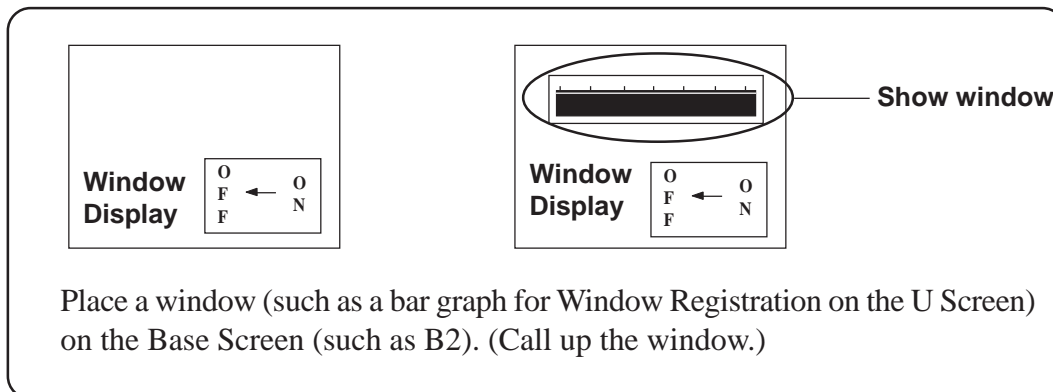
Procedure for placing Window Parts will be shown below.

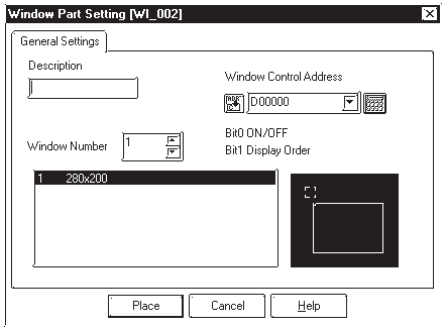

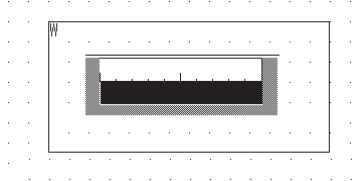
PROCEDURE	REMARKS
<p>(1) Select [Window Parts] from the [Parts] menu or click the  icon.</p> <p>(2) Select the window to be displayed on the Base Screen (B) from the "Window Number" field. Specify the Window Control Address as well.</p>  <p>(3) Click the  button after setting all attributes. The border of the window area is displayed on the drawing area.</p> <p>(4) Click on the point where the Window Part is to be placed.</p> 	<p>For Window Registration of parts on the Window Screen (U)</p> <p>Reference 3.7.2 <i>Window Registration on the U Screen</i></p> <p>When the specified area is overlapped by objects on the Base Screen, the object will be hidden while the window is displayed.</p>

2.2 Drawing

Straight lines, rectangles, and oval objects can be drawn, using drawing tools.

An object's attributes such as line types and colors are designated in its dialog box. After designating the object's attributes, move the cursor and start to draw the object directly in the drawing area.

Note: These objects can also be drawn via the Keypad and Trend Graph screens.

Usage Pattern			
[Draw]	→	Select a drawing command	→ Set any attributes → Draw the object
or			
Select a desired drawing icon from the Draw Tool Bar.			

■ Drawing Tools

Icons contained in the Draw Tool Bar and their corresponding drawing objects are as follows:

Icon	Object Types	Icon	Object Types
	Dot		Filled Polygon
	Line/Poly-line		Scale
	Square/Rectangle		Text
	Circle/Oval		Load Screen
	Arc/Pie		Load Mark
	Fill	/	

■ Selecting Line Types

10 selections are available for straight and poly-lines, and for graph divisions. 6 selections are available for rectangles, circles, arcs and pie sections.

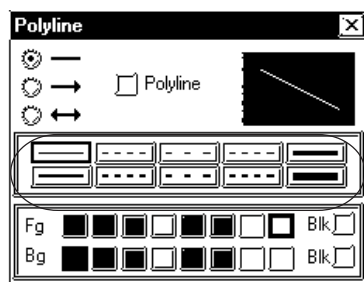

Select one of these patterns

■ **Selecting Colors**

For color and blink attribute settings, use the procedure same as for Parts.

▼ **Reference** 2.1 Parts ■ *Part Attributes - Selecting Colors*

■ **Tiling Patterns**

Nine different tiling patterns are available. These patterns can be selected for squares, circles, filled squares and polygonal objects. When combining foreground (Fg) and background (Bg) colors, a variety of filled patterns can be drawn.

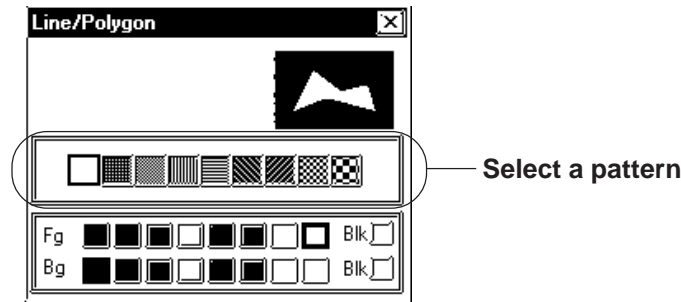

When a square or circle is drawn, only the line type will be displayed initially. To display the pattern selections, check the Fill check box. (check mark will appear)

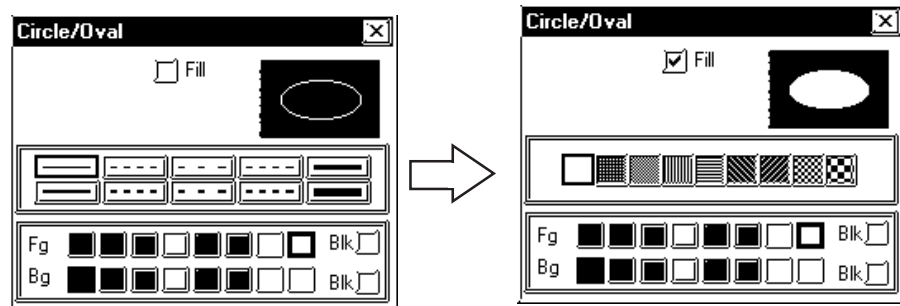



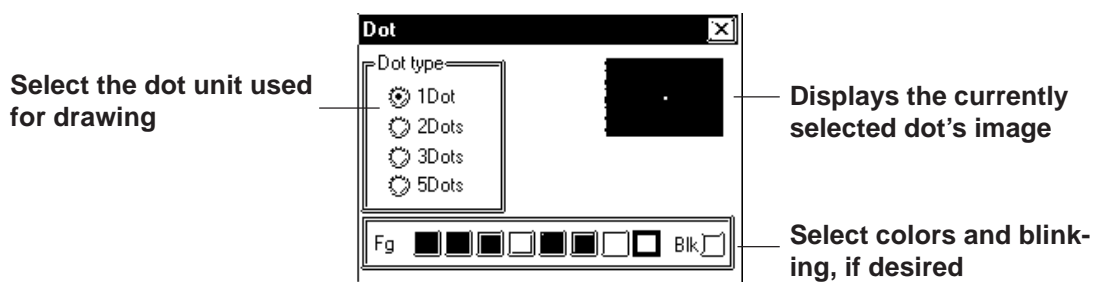

2.2.1 Dot

Dots can be drawn in 1, 2, 3, and 5 dot units. To draw a dot, simply click on the desired point.

■ **Dot Attributes**

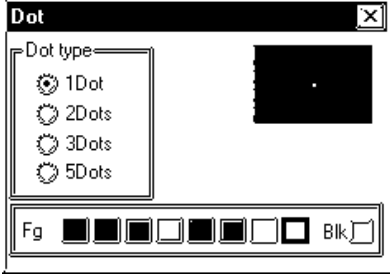
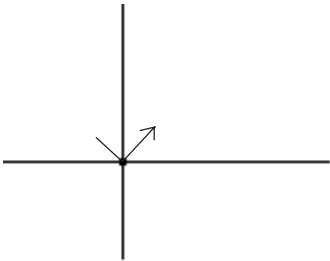

■ Creating a Dot

PROCEDURE	REMARKS
<p>(1) Select the [Draw] menu - [Dot] command, or click on the  icon.</p> <p>(2) Set the attributes of a dot to be drawn. Select a dot type and colors, if desired.</p>  <p>(3) Move the cursor to the drawing area. A dot will be drawn at the point clicked on.</p> 	<p>If an arrow () is selected, the line's end point will become an arrow.</p> <p>When using the keyboard to draw a dot, move the cursor to the desired point and press the  key.</p> <p>To cancel/delete the dot, click on the  icon.</p> <p>Double-clicking on any object drawn on the screen automatically calls up that object's Attribute Settings dialog box.</p> <p>Reference  2.4.14 <i>Changing Attributes</i></p>

2.2.2 Line/Poly-line

In order to draw a line, simply click to designate the line's start and end points. A continuous straight line can also be drawn; holding down the key allows you to draw lines at precisely 0°, 45°, or 90° angles.

Line/Polyline Attributes

When drawing a polyline, check this box

Selects a line type (with or without arrows)

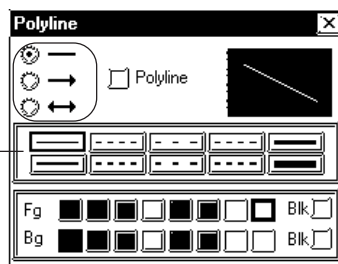

Selects a line type



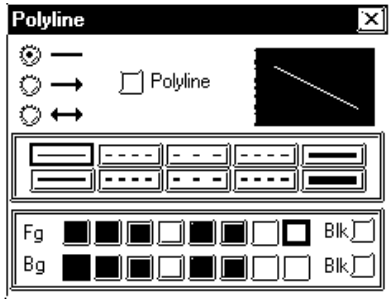
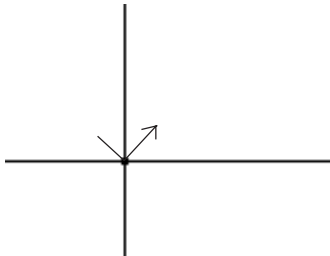

The currently selected line's image appears here

Select a color, and blinking, if desired

Drawing a (Straight) Line

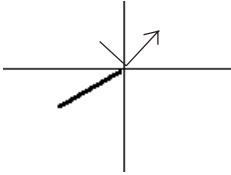
PROCEDURE	REMARKS
<p>(1) Select the [Draw] menu - [Line/Poly-line] command, or click on the  icon.</p> <p>(2) Set the attributes of a straight line to be drawn. If necessary, select the color and line type.</p>  <p>(3) Move the cursor to the drawing area, click on the line's starting point and drag the mouse to the end point.</p> 	<p>In step (4), while holding the  key down, a straight line at an angle of either 0, 45, or 90 degrees can also be drawn.</p> <p>When using the keyboard to draw a straight line, use the arrow keys to move the cursor to the start and end points and press the  key, to start and finish the line.</p>

PROCEDURE	REMARKS
<p>(4) Click again; a straight line is drawn (registered).</p> 	<p>To cancel the placement, click on the  icon.</p> <p>Double-clicking on any object drawn on the screen automatically calls up that object's attribute settings.</p> <p>Reference 2.4.14 <i>Changing Attributes</i></p>

■ Drawing Polylines

When the Polyline check box is checked, Polylines can be drawn. Click on the starting point then drag the mouse, clicking the left mouse button at each point of the desired directional change of the line; and, click on the right mouse button at the end point of the line.



- When drawing, if the Keyboard's  key is pressed instead of clicking on the mouse right button, the start and end points of a polyline object will be automatically connected.
- You can draw a line that looks hand-drawn by holding down the mouse's left button when drawing a polyline.

2.2.3 Square/Rectangle

To draw a square, click on and designate the diagonal two points.

To draw a regular square, perform this operation while holding down the **Ctrl** key. By selecting a pattern before drawing, a filled square also can be drawn. Both normal (non-filled) and filled squares can be beveled.

■ Square Attributes

Check this check box when drawing a filled Square/Rectangle

Selects the type of Square/Rectangle

Selects a line (border) type

Select a Color and blinking, if desired

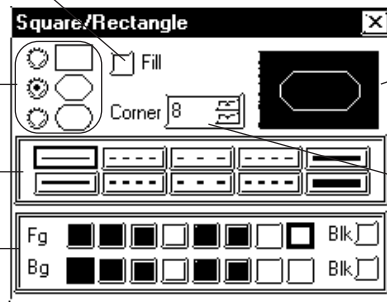

Displays the currently selected Square/Rectangle type

When selecting Corner, this number designates the number of dots used

<Filled Square/Rectangle Setting Screen>

Select one of the tiling patterns

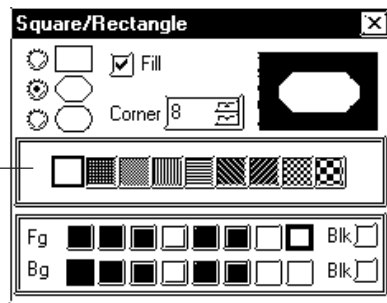

◆ Square Shapes and Beveling types



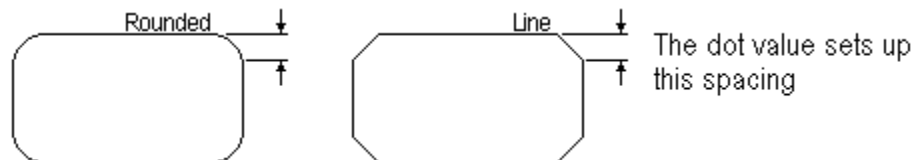

Square shapes and beveling types are as shown below.

- Not beveled.
- All corners are beveled with straight lines.
- All corners are beveled with arcs.

When selecting Beveling, input a bevel dot number.

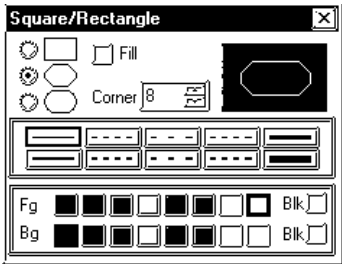
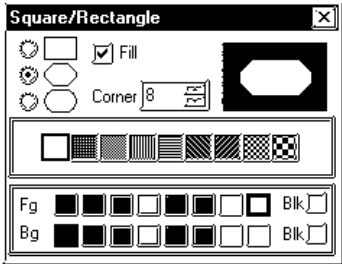
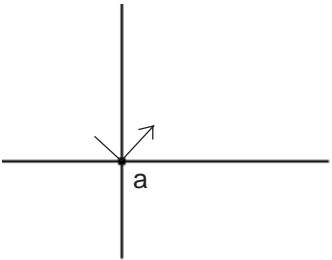
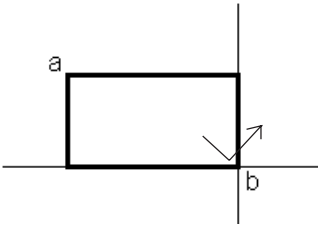

■ Drawing a Square/Rectangle

PROCEDURE	REMARKS
<p>(1) Select the [Draw] menu - [Square/Rectangle] command, or click on the  icon.</p> <p>(2) Set the attributes of the square/rectangle to be drawn. If desired, select the colors, line types, beveling type and dot. When drawing a filled square, check the Fill check box, instead of selecting line types.</p>  <p style="text-align: center;">↓ Select a pattern</p>  <p>(3) Move the cursor to the drawing area and click on the first of the diagonal's points, "a".</p>  <p>(4) Click on the diagonal's other point "b". The rectangle is automatically drawn (registered).</p> 	<p>Reference 2.2.3 ■ Square Attributes, ◆ Square Shapes and Beveling types</p> <p>In step (4), hold down the  key to draw a square.</p> <p>When using the keyboard to draw a square, use the arrow keys to move the cursor to the rectangle's two diagonal points and press the  key to start and finish the rectangle.</p> <p>To cancel the placement, click on the  icon.</p> <p>Double-clicking on any object drawn on the screen automatically calls up that object's attribute settings.</p> <p>Reference 2.4.14 Changing Attributes</p>

2.2.4 Circle/Oval

To draw a circle or an oval, click on its center point and drag the mouse to the circumference point, and click again. Holding down the **[Ctrl]** key draws a perfect circle. To draw a filled circle or oval, select the desired pattern.

Circle/Oval Attributes

Check this check box, if a filled Circle/Oval is desired

Select a Line/Border type

Select a Fg and Bg color, and blinking, if desired

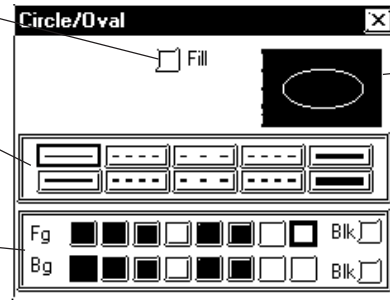

Displays the currently selected Circle/Oval image

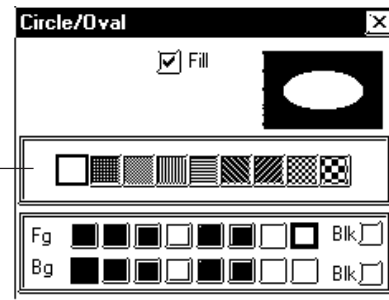

<Filled Circle/Oval Setting Screen>

Select one of the Tiling patterns

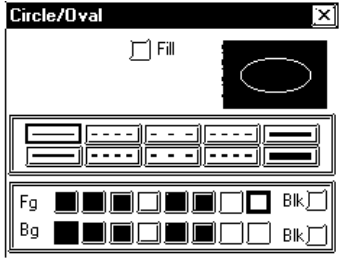

Drawing a Circle/Oval

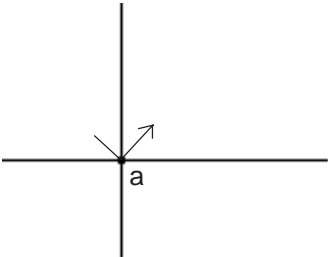
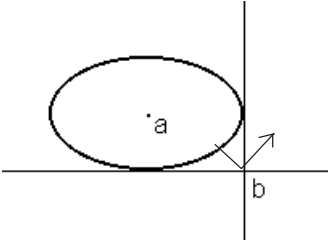
PROCEDURE	REMARKS
<p>(1) Select the [Draw] menu - [Circle/Oval] command, or click on the  icon.</p> <p>(2) Set attributes of an oval to be drawn. Select colors and a line type, if desired. To draw a filled oval, check the Fill check box and select a pattern, instead of selecting a line type.</p> <div style="text-align: center;">  <p>Select a Pattern</p> </div>	

PROCEDURE	REMARKS
<p style="text-align: center;">↓</p>  <p>(3) Move the cursor over the drawing area, and click on the center point, shown here by “a”.</p>  <p>(4) As the cursor is moved, the oval will expand or contract. Click on the point shown by b. The drawn oval will be registered.</p> 	<p>In step (3), if the [Shift] key is held down, you can draw an oval which contacts a specified area (i.e. the side(s) of a square). This function is useful when drawing an inscribed circle and can also be used in step (4), together with the [Ctrl] key.</p> <p>To draw a regular circle, hold the [Ctrl] key down in step (4).</p> <p>When using the keyboard to draw an oval, use the arrow keys to move the cursor to the center point and then, to the point which defines its circumference (radius point), pressing the [↵] key each time.</p> <p>To cancel a drawing action, click on the  icon.</p> <p>Double-clicking on any object drawn on the screen automatically calls up that object’s attribute settings.</p> <p>Reference 2.4.14 <i>Changing Attributes</i></p>

2.2.5 Arc/Pie

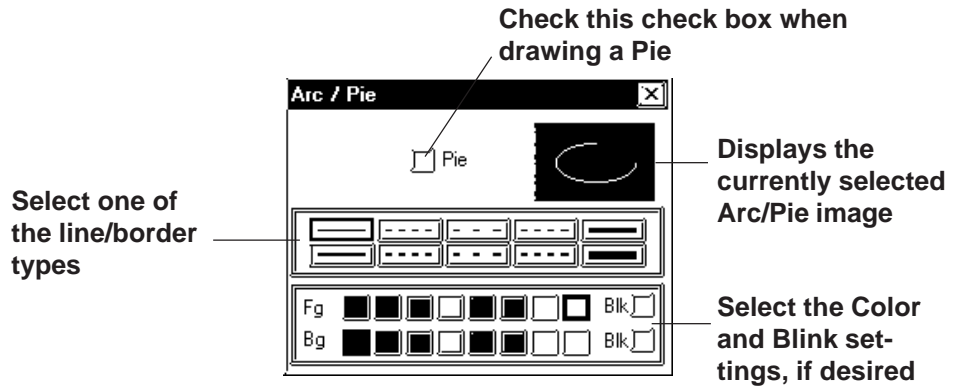

To draw an arc or pie, a portion of a circle must be selected. You will need to first draw a circle, and then, click on the arc's beginning and end points.

■ Arc/Pie Attributes

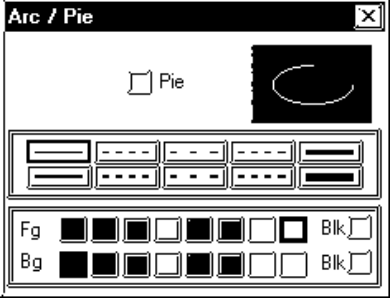
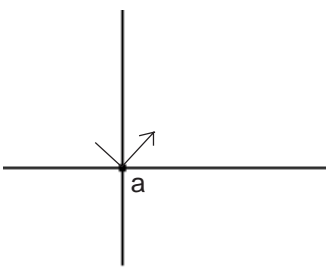

■ Drawing an Arc

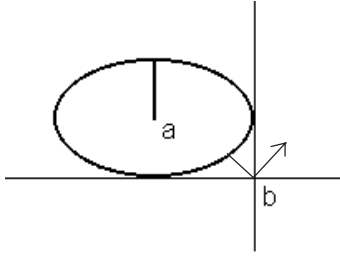
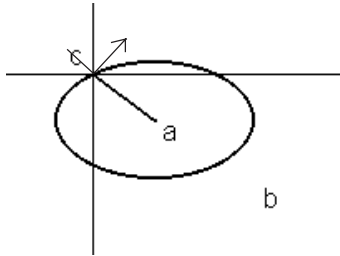
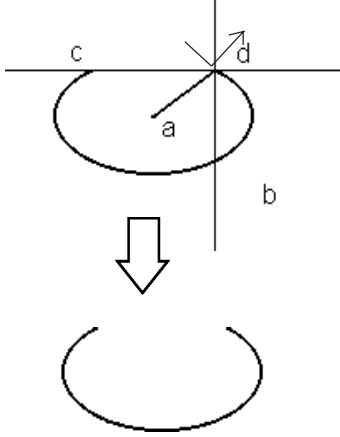
PROCEDURE	REMARKS
<p>(1) Select the [Draw] menu - [Arc/Pie] command, or click on the  icon.</p> <p>(2) Set the Arc's attributes. Select Colors and line type, if desired.</p>  <p>(3) Move the cursor to the drawing area and click on the oval's center point "a".</p> 	<p>In step (3), if the [Shift] key is held down, you can draw an oval which contacts a specified area (i.e. the side(s) of a square). This function is useful when drawing an inscribed circle and can also be used in step (4), together with the [Ctrl] key.</p>

PROCEDURE	REMARKS
<p>(4)Click on the oval’s radius point “b”. An oval will appear and the arc’s base line will be displayed.</p>  <p>(5)Click on the arc’s start point “c” or on its elongation.</p>  <p>(6)Click on the arc’s end point “d”. The arc will be drawn (registered).</p> 	<p>In step (4), holding down the Ctrl key draws a circular arc.</p> <p>When using the keyboard to draw an arc, use the arrow keys to move the cursor first, to its center point, then, to another point on its circumference (radius point), and then, to its start and end points. Press the  key after specifying each of these points.</p> <p>To cancel the drawing action, click on the  icon.</p> <p>Double-clicking on any object drawn on the screen automatically calls up that object’s attribute settings.</p> <p>Reference 2.4.14 <i>Changing Attributes</i></p>

■ Drawing a Pie (Sector)

Follow the same steps used for the drawing of Arcs.

When using the same procedure to draw an Arc:

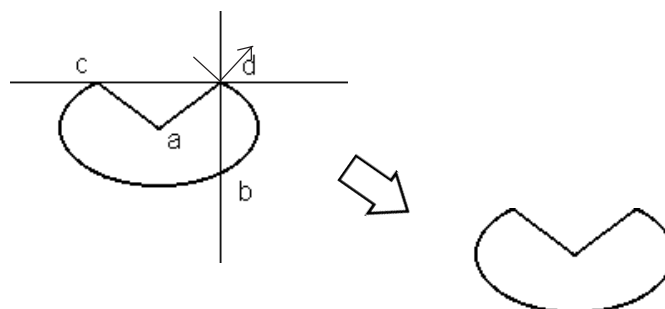

2.2.6 Fill

To use the Fill command, simply left-click your cursor on top of an object's enclosed area. The selected Fill pattern will then spread outward until it reaches a boundary. A boundary can be any line or Fill that is the same color as that chosen for the Fill's foreground, background, or border.



<Cautions when Filling an Object>

- **Be sure that the area to be filled is completely enclosed with solid lines. Dotted lines can not be used as an enclosure.**
- **A space of only one dot on the border of an enclosed area is enough to allow Fill to leak into other areas of the screen. Be especially careful when drawing polygon vertexes and filling an object while the display is set to 50%.**
- **DO NOT attempt to fill objects that have been designated as blinking.**
- **When filling an image that uses an arc, Fill may leak when that image is actually displayed on the GP panel display. To prevent this, use a line to connect any gaps in the image.**

■ Fill Attributes

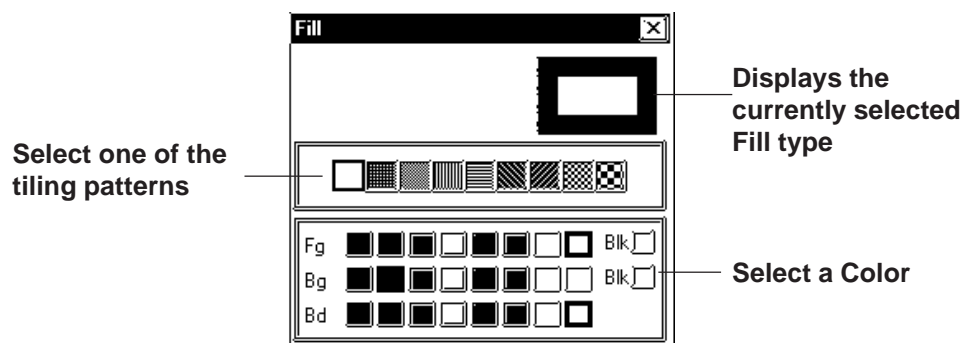





- To select the background color for all the screens used, use the [Option] menu's [Screen Settings] command.

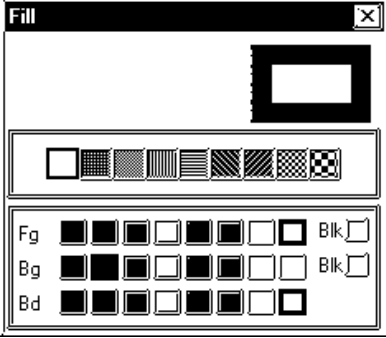
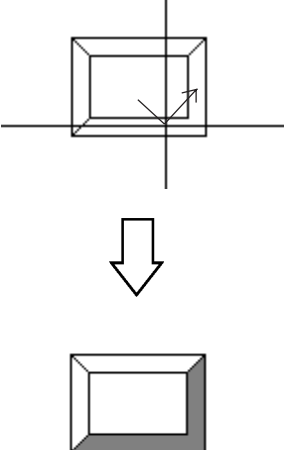
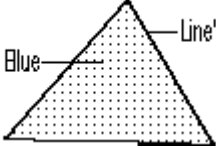

▼ **Reference** ▲ 2.8.2 ■ *Setting Screen Property - [Color]*

- To cancel the application of a Fill due to a mistake, such as having designated the wrong Fill point, press the Esc key.

■ Filling an Object

PROCEDURE	REMARKS
<p>(1) Select the [Draw] menu - [Fill] command, or click on the  icon.</p> <p>(2) Set the attributes. Select Colors and Tiling Patterns, if desired.</p>  <p>(3) Move the cursor to the drawing area and click on the area to be filled. The designated area will be filled in.</p> 	<p>Fill spreads outward from the selected point until it reaches a border with one of the colors (Fg, Bg, Bd) selected in step (2).</p> <p>Select the same color for the Bd (border) Color and boundary Fg (foreground) Color.</p> <p>E.g.</p>  <p>Left-clicking on a line will not cause it to be filled. Be sure to only click in an area enclosed by lines.</p> <p>When drawing via the PC's keyboard, press the  button to indicate a fill point. Fills and fill points can be specified to either display or not display via the drawing board.</p> <p>Reference 2.8.2 <i>Screen Property Settings</i></p> <p>To cancel Fill due to a mistake, such as designating a wrong Fill point, press the  key.</p> <p>To cancel the filling, click on the  icon.</p> <p>Double-clicking on a filling point of any filled object drawn on the screen automatically calls up that filled object's attribute settings.</p> <p>Reference 2.4.14 <i>Changing Attributes</i></p>

2.2.7 Line / Polygon

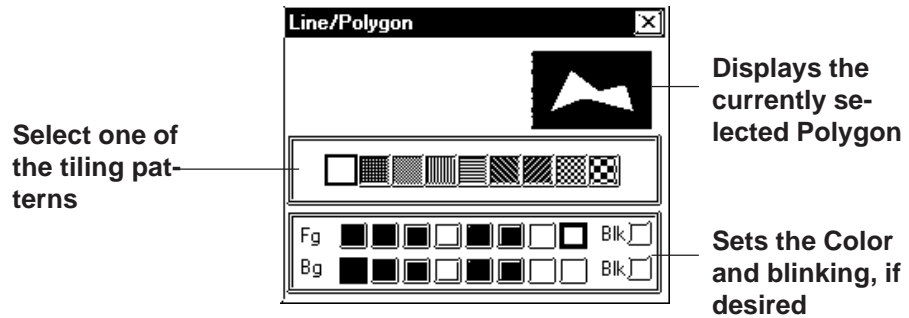

To draw a Polygon, either Left-click or press the  key to indicate the Polygon's vertices. To complete the Polygon, either right-click or press the  to automatically connect the beginning and end points. Holding down the  key while drawing a Polygon will snap the polygon's segments to 45 degree angles.

■ Polygon Attributes

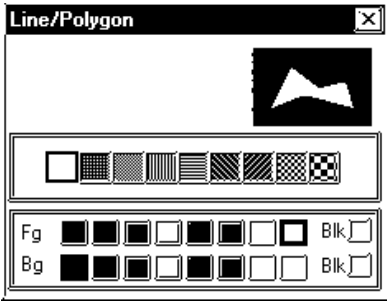
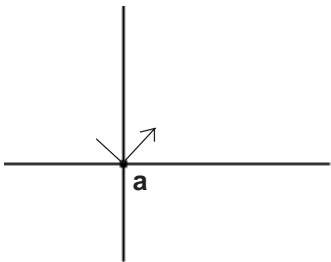

■ Drawing a Polygon

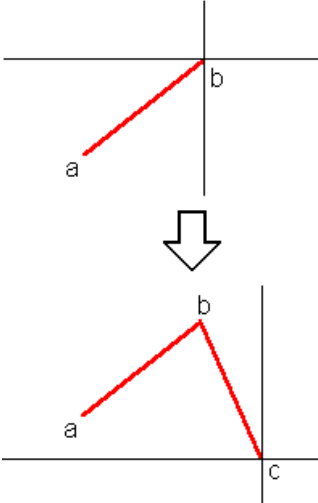
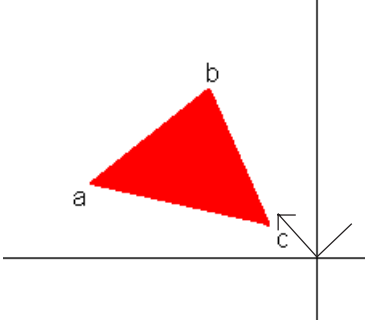
PROCEDURE	REMARKS
<p>(1) Select the [Draw] menu - [Filled Polygon] command, or click on the  icon.</p> <p>(2) Set attributes of a polygon to be drawn. Select Colors and Tiling Pattern, if desired.</p>  <p>(3) Move the cursor to the drawing area and click on the start point "a".</p> 	

PROCEDURE	REMARKS
<p>(4) Left-click to designate the positions of the Polygon's vertices. Repeat this for as many vertices as needed. Here, points b and c are also shown.</p> 	<p>Up to 100 corners (faces) can be created.</p> <p>In step (4), holding the Ctrl key causes lines to be drawn at exactly 0, 45, or 90 degree angles.</p>
<p>(5) After defining the final vertex, c, right-click or press C to complete and fill the Polygon. Points a and c are joined and the object is filled.</p> 	<p>To cancel the drawing, click on the  icon.</p> <p>Double-clicking on any object drawn on the screen automatically calls up that object's attribute settings.</p> <p>Reference 2.4.14 <i>Changing Attributes</i></p>



Note: • About Filling a Polygon

When a polygon's segments overlap, the filling alternates, so that areas next to each other do not display the same pattern. As a result, areas without any fill (white) may develop inside the polygon. If fill is desired in these areas as well, click on the  icon.

E.g.



2.2.8 Scale



To draw or create a Scale, input the number of divisions desired and then left-click the mouse's cursor to designate the scale's beginning and end points. Scales can be either horizontal or vertical, linear (straight line) or curved (semi-circle).

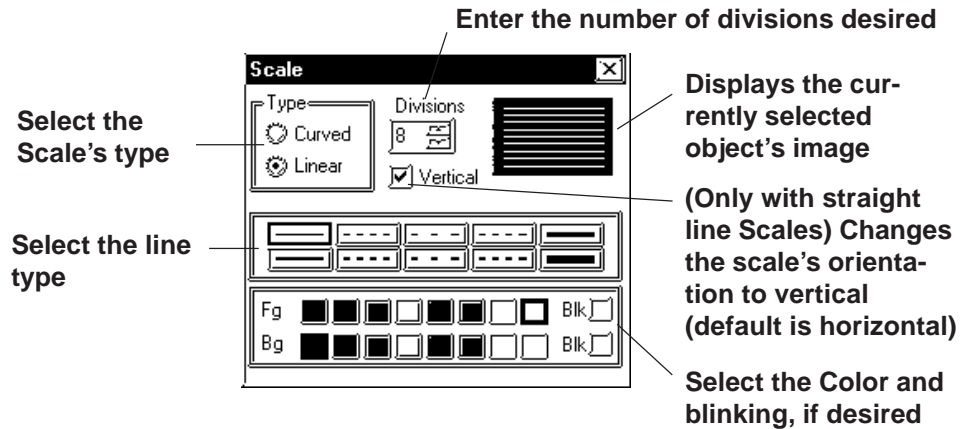

Scale Attributes

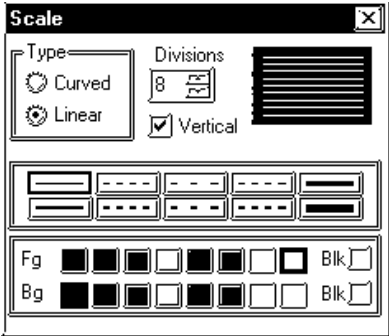

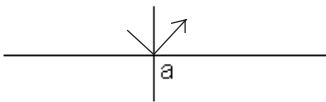
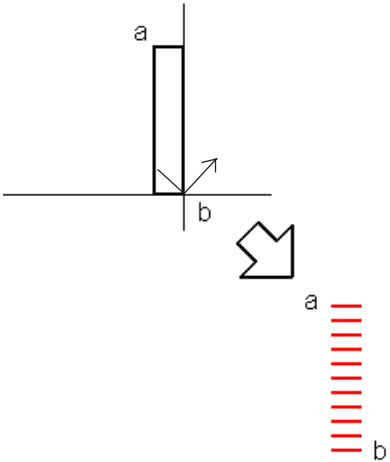
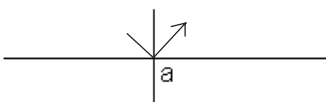
Drawing a Scale

PROCEDURE	REMARKS
<p>(1) Select the [Draw] menu - [Scale] command, or click on the  icon.</p> <p>(2) Set the attributes of the divisions to be marked. Select the Scale's colors, line type, and Scale type, and input the number of scale divisions. If "Linear" is selected as the type, select the orientation direction by clicking on the Vertical check box. (Unchecked means Horizontal)</p> 	<p><Number of Divisions></p> <p>When the number of the divisions is specified as 8, a total of 9 division lines will be displayed. (i.e. the number entered + 1)</p>

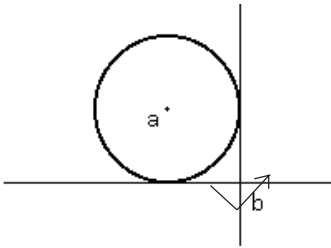
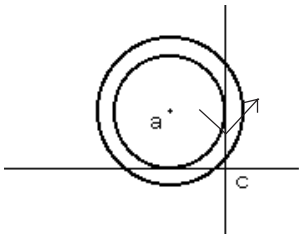
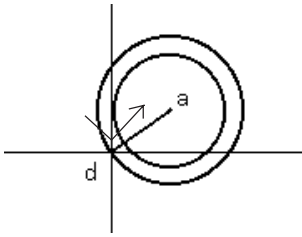
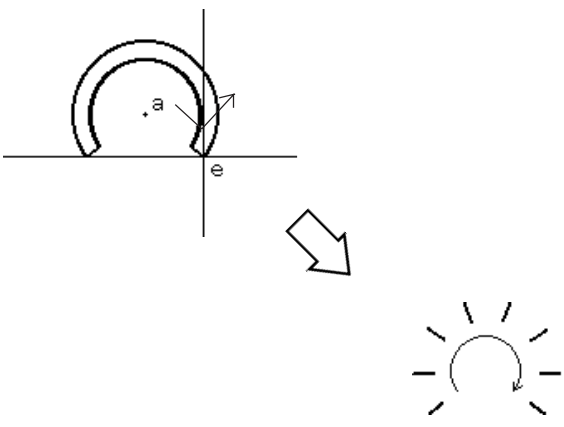
PROCEDURE	REMARKS
<p>The following explanation is divided into two parts; first, when creating a linear type scale, and second, when creating a curved type scale.</p> <p>[Creating a Linear type scale- (Vertical, with 8 divisions)] Specify the area of division lines by a rectangle.</p> <p>(3) Use the mouse's cursor to create a rectangle in the drawing area, i.e. left-click to indicate the linear scale's start point, a.</p>  <p>(4) Complete the rectangle by left-clicking on the Scale's end point, b. The rectangle shape will disappear, and be replaced by division lines.</p>  <p>[Creating a Curved type scale- (8 divisions)] Specify the area of division lines, using double circles.</p> <p>(3) Use the mouse's cursor to create a circle on the drawing area, i.e. left-click to indicate the curved scale's start point, a.</p> 	<p>Holding down the Ctrl key while performing step (4) will draw a perfect square.</p> <p>When using the keyboard to perform drawing, press the Enter key to designate the start and finish points.</p> <p>To cancel the drawing, click on the  icon.</p>

PROCEDURE	REMARKS
<p>(4) Click on the radius point “b”, which is of a scale’s outer circle.</p>  <p>(5) Draw another circle inside the circle drawn in step (4) to decide the width of the scale. Click on this inner circle’s radius point “c”.</p>  <p>(6) Rotate the displayed segment and click on the scale start point “d” or on its elongation.</p>  <p>(7) Then, rotate the segment again until you reach the desired end point e, and click to designate the end of the scale’s divisions.</p> <p>Division lines appear inside the area surrounded with the double circles and the two segments. They will be drawn clockwise from the start point to the end point.</p> 	<p>When using the keyboard to draw divisions, press the  key after moving the cursor to the division circle’s center point, to the other point on its circumference (radius point), and then to the divisions’ start and end points.</p> <p>To cancel the drawing, click on the  icon.</p> <p>Double-clicking on any object drawn on the screen automatically calls up that object’s attribute settings.</p> <p>Reference 2.4.14 <i>Changing Attributes</i></p>

2.2.9 Text

From the keyboard enter the text and then place it on the screen. This software has two methods of placing text on the screen. The first method defines the placement point, and the second defines the area where the text will be centered.

■ **Text Attributes**

Select the type of text.

Enter the text used as direct text.

Select the style of the text. (This feature is not available with Image Font.)

Specify the character size.

Image text is compressed when this option is selected.

Select the desired font when using Image Font for Direct Text.

Displays a sample of the current text's attributes.

Select the text's display direction. (This feature is not available with Image Font.)

Select the Fg and Bg colors, and blinking.

◆ **Direct Text**

The text entered in the text entry field is placed directly as a fixed text string. A maximum of 100 characters can be entered per line, and 100 lines per screen.

◆ **Index Text**

Select and add the Index Text.

Reference 4.6.3 ■ *Selecting the index character string* ◆ *Entering the index character string*

◆ **Image Font**

Note: Text using Windows fonts is displayed in bitmap format. This feature is enabled only when "Direct Text" mode is selected.

• Image Font is supported by the GP-2000 series only.

Click the [Select Font] button and specify the Font, Style and Size settings.

Displays a sample of the current text's attributes



- When Image Font is selected, the [Style] and "Vertical" text ("Vertical" under the "Direction" setting) cannot be specified.
- Image Font increases the size of the Project file. We recommend that the "Compress" setting be enabled.
- The maximum capacity of one text string is 50KB when Image Font is used.

Capacity of text with Image Font (Bytes)	=	(Number of dots for text width/8)	X	Number of dots for text height
--	---	--------------------------------------	---	-----------------------------------

◆ **Compress**

This feature is enabled only when the Image Font option is selected. The Image Font is compressed to one-half its original size. (The compressed size may vary depending on the text.)

◆ **Character Size**

Clicking on the font size display area, displays the current character size (used after text is placed on the drawing area). Move the cursor to where the X and Y axis lines cross, and drag the cursor. As the axis lines move, the character size will change. Click on the text block again, or press the  key to register (enter) the change.

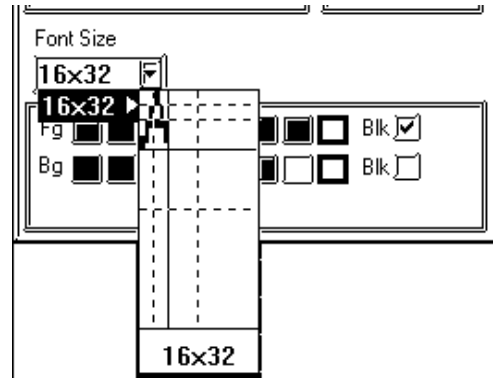

		Single Byte Font		Double Byte Font	
Character Size	1 x 1	8 x 8	16 x 16	16 x 8	16 x 16
	2 x 2	16 x 16	32 x 32	32 x 16	32 x 32
	4 x 2	32 x 32	64 x 64	64 x 32	64 x 64



- Specify the point size when the Image Font option is selected. You can also specify the point size by clicking the [Select Font] button and selecting the font size in the [Size] field.
- When the text is zoomed in or zoomed out while the **Ctrl** key is pressed under Image Font mode, the text may exceed the frame of the system part.

◆ **Style**

Characters can be either Normal, Bold, or Raised.

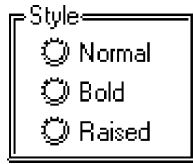

- When text character backgrounds (Bg) is specified to Black + Blk (Blink), transparent mode is used, thereby displaying that area as transparent. For 256-color mode, select the last (255th) color, which is "Clr". However, for the GP unit with three blink speeds, this mode can be specified only when the "Mid" speed is selected. If an object has been drawn underneath these characters, they (the characters) will appear transparent, showing the object behind. This function is useful when overlaying text on objects, i.e., over the face of Switches and Lamps.

▼ **Reference** ▲ 2.2 ■ *Selecting Colors*

- You cannot specify the style when Image font is selected.

■ **Changing to a New Text Line and Line Settings**

When entering characters, simply press the  key to move to a new line. When there are 2 or more lines of text, icons will appear to allow adjustments in line spacing, and justification.

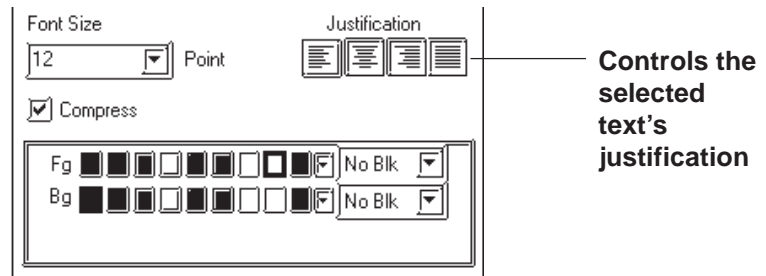





Controls the selected text's justification

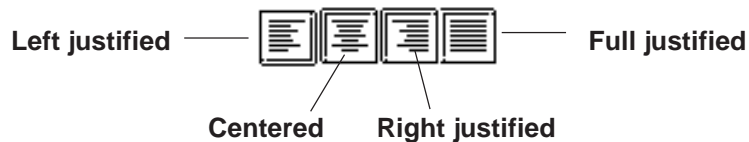

◆ **Justification**

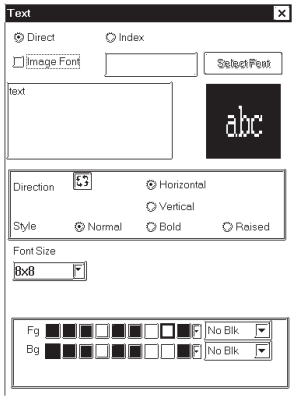
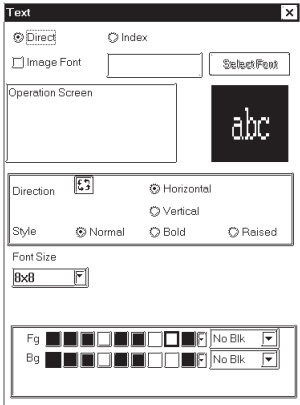
Horizontal text's alignment can be changed to either Left, Center, Right or Full justified.

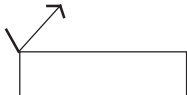

■ Entering Text

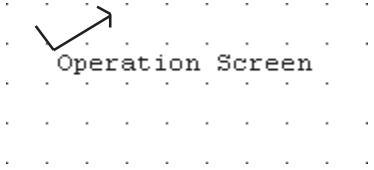
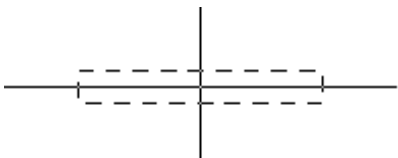
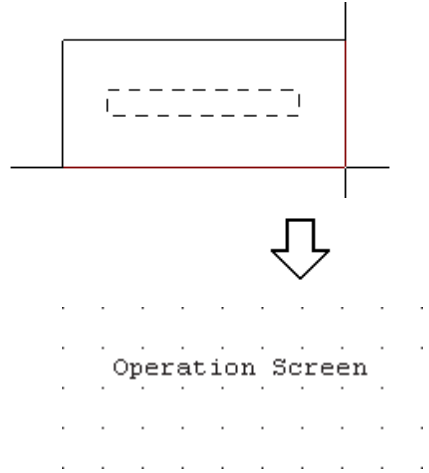
PROCEDURE	REMARKS
<p>(1) Select the [Draw] menu - [Text] command, or click on the  icon.</p> <p>(2) Set the attributes of the characters to be input. Select Colors and Character Size, if desired.</p> 	<p>When selecting [Index]:</p> <p>Reference 4.6.3 ■ <i>Select the index character string</i> ◆ <i>Entering the index character string</i></p> <p>The attributes can also be entered and selected after entering text.</p> <p>When “Raised” is selected for Character Type, the border color (Bd) will become shadowed (i.e. 3-D).</p>
<p>(3) Click on the text field to input characters, via your PC’s keyboard, when selecting [Direct]. Simply clicking on the text field allows you to input characters there.</p> 	<div style="text-align: center;">  <p>important</p> </div> <p>·When the Image Font is selected, the "Direction" (Vertical/Horizontal) and "Style" text settings are disabled.</p>
<p>Hereafter, two text alignment cases will be explained, one not using and one using the Centering function:</p> <p><When Centering function is NOT used></p> <p>(4) Move the cursor to the drawing area and click on any desired point.</p> <p>After clicking on a point in the drawing area, a text box the size of the selected character will appear on the screen. The top left corner of the text box is the base point used for positioning.</p> 	<p>When using your PC’s keyboard to enter text, press the  key to designate a position.</p>

PROCEDURE	REMARKS
<p>(5) Move the cursor to the desired position and left-click the mouse to place it on the screen.</p>  <p><When the Centering function IS used></p> <p>(4) Move the cursor over the desired placement area and, while holding down the Shift key, click on any desired point. After clicking on a point in the drawing area, the text box will appear on the screen in dotted line.</p>  <p>(5) Select a centering area that is the same size or larger than the previously selected text area. The designated size's text box will appear in the center of the selected area.</p> 	<p>To cancel the placement, click on the  icon.</p> <p>Double-clicking on any object drawn on the screen automatically calls up that object's attribute settings.</p> <p>Reference 2.4.14 <i>Changing Attributes</i></p> <p>To cancel the designated area, click the right mouse button.</p>



- **GP-PRO/PBIII for Windows uses the PC's font. As a result, the text that you see on the GP display and that shown on the PC may differ.**
- **In both GP-PROIII and GP-PRO/PBIII (DOS Ver.), when an object is overlaid on a text block, the text block will be displayed in the foreground. With GP-PRO/PBIII for Windows, however, the text block will be placed behind the object. When the GP-PROIII and GP-PRO/PBIII (DOS Ver.)'s data is used in the GP-PRO/PBIII for Windows, the text block will be displayed in the foreground.**

2.2.10 Load Screens

Graphics created on screens in a project can be loaded and used repeatedly on others with GP-PRO/PB III for Windows. Thus, a single screen's contents can be used repeatedly elsewhere. The Load Screen function is also a good way to cut down on your screen's actual size, since you only need to call up items to your screen, not save them on it.

■ Screens that can be loaded to other screens

Current Screen	Loadable Screens
B (Base) screen	B (Base) screen
	T (Trend graph) screen
	K (Keypad) screen
	I (Image) screen
	I (Image) screen-CF card
T (Trend graph) screen	B (Base) screen
	I (Image) screen
	I (Image) screen-CF card
K (Keypad) screen	B (Base) screen
	I (Image) screen
	I (Image) screen-CF card
U (Window) screen	B (Base) screen
	I (Image) screen
	I (Image) screen-CF card

Only one (1) Keypad can be loaded onto a Base screen. The screen currently being edited cannot be loaded on to itself.



If any portion of a Trend Graph screen extends over a Base screen's border, the Trend Graph screen will not display correctly on the GP screen.



If a portion of an Image screen extends over a Base screen's Y axis border, that portion will not be displayed on the GP screen. When the Image screen is placed over the Base screen laterally, however, any part that extends over the Base screen X axis border will be squeezed onto the GP screen.(i.e. not cut)

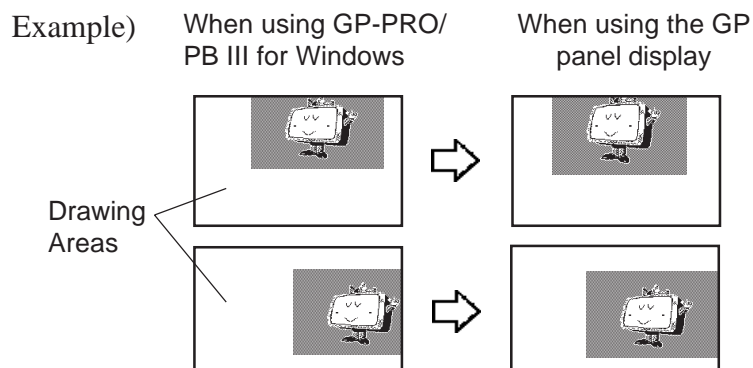

■ Nesting

Screens can be nested up to 10 times (11 layers). However, if your PC's system memory is low, a loaded screen/object may not be displayed. Later, however, when the data is transferred to the GP, the display will appear normally.

E.g.) Nesting Objects Twice (3 layers)

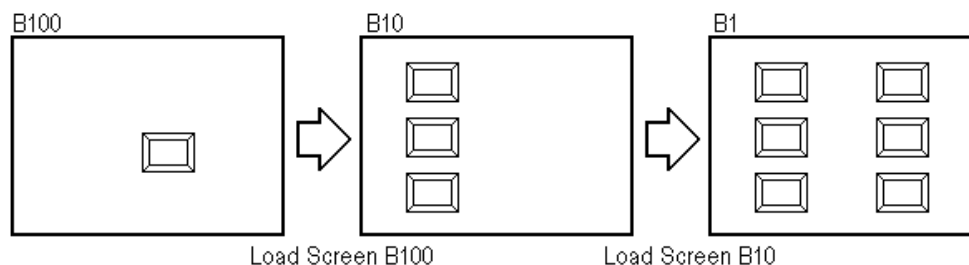



Note: The load screen nesting condition can be viewed via the load screen nesting display function.

Reference 2.8.9 Display of Screen Level Change Structure

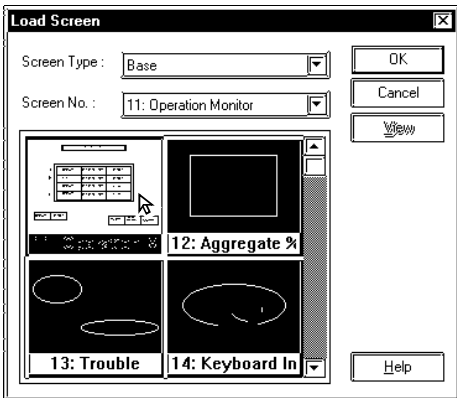
■ Loading a Screen

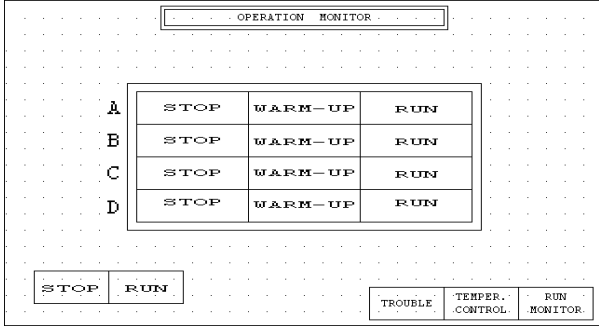
PROCEDURE	REMARKS
<p>(1) Select the [Draw] menu - [Load Screen] command, or click on the  icon.</p> <p>(2) Select a desired screen from the list or enter that screen's number directly on the [Screen No.] field via the keyboard, and then click on the <input type="button" value="OK"/> button. Then, the screen's outline and center point will appear in the drawing area, next to your cursor.</p> 	<p>Only screens in the currently used Project file can be loaded. Screens in other project files can not be loaded.</p> <p>The current (selected) Screen cannot be loaded on to itself.</p>

PROCEDURE	REMARKS
<p>(3) Click on the point where the Screen's top left corner is to be placed. The image's center point is left top corner of its border, and for other objects, the screen center mark will be the placement point.</p> 	<p>A loaded screen cannot be edited while it is being used on a different (i.e. loaded) screen. You will need to open the original screen to perform any editing.</p> <p>To cancel the loading, click on the  icon.</p>



Note: When calling up a filled object:

When the current screen's graphics overlap loaded filled (painted) graphics, depending on the color used, unfilled areas may be created. To correct this, add a fill to the current screen's unfilled area.

Reference 2.2.6 Fill

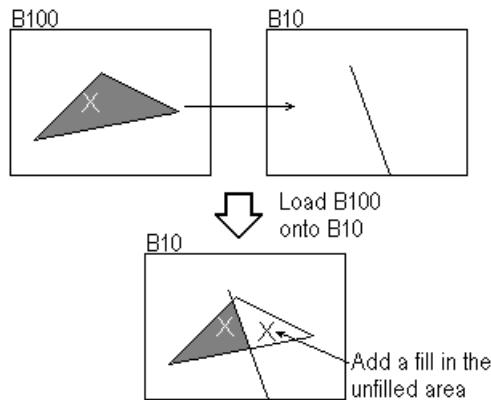



- If a background color is selected for the screen used for screen call-up, the object placed on the screen will not be displayed on the GP.
- To call up the screen for which a background color has been selected, specify the center of the screen as the call-up position and then place the screen.

2.2.11 Load Mark

Marks (dot images) created in a Mark screen can be loaded and used repeatedly on Base/Trend Graph/Keypad/Window screens.

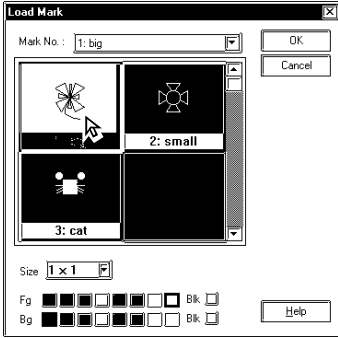
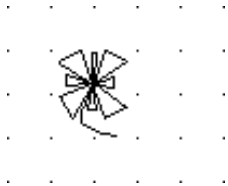
■ Loading a Mark Screen



PROCEDURE	REMARKS
<p>(1) Select the [Draw] menu - [Load Mark] command, or click on the  icon.</p> <p>(2) Select a desired Mark screen from the list or enter that screen's number directly on the [Screen No.] field via the keyboard, and then click on the <input type="button" value="OK"/> button.</p> <p>The Mark's outline will appear in the drawing area, next to your cursor.</p> <p>Designate its color and size before clicking on the [OK] button, if desired.</p>  <p>(3) Click on the point where the Mark's top left corner is to be placed.</p> <p>If desired, use the Mark's handles to alter its size.</p> 	<p>Only Mark screens in the current project can be loaded. Mark screens in other projects are not available.</p> <p>When the screen display size is 50%, the loaded Mark may not be displayed correctly on the GP-PRO/PB III for Windows software.</p> <p>To cancel the loading, click on the  icon.</p> <p>To change the Mark's size, refer to Reference 2.4.3 Scaling Up/Down</p> <p>Double-clicking on any Mark loaded on the screen automatically calls up that Mark's attribute settings.</p> <p>Reference 2.4.14 Changing Attributes</p>



2.2.12 Convert (Import) Image

This section describes how to convert image data (bitmap: BMP file and JPEG: JPEG file), created from other drawing software or imported from a scanner, for use on a GP Image (I) screen.

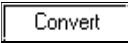
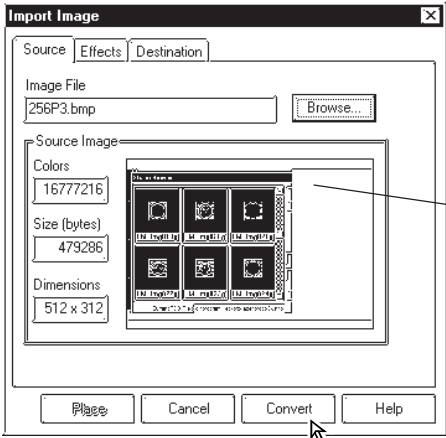
Reference For Image Conversion data, refer to *3.5 Creating an Image: the Image Screen*

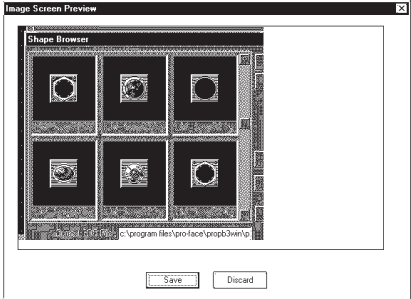
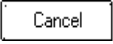
■ Converting and Placing an Image

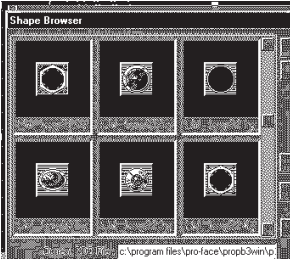
PROCEDURE	REMARKS
<p>(1) From the menu bar of the screen editor [Draw] menu's [Convert Image...] command.</p> <p>(2) Set all conversion settings and click on the  button.</p>  <p>(3) Click on the  button. The data is then saved as an Image screen.</p> 	<p>Once an image has been converted, it can be placed on a screen using the Load Screen function.</p> <p>Reference 2.2.10 Load Screens</p> <p>For each setting item,</p> <p>Reference 3.5 Creating an Image: the Image screen</p> <p>Before conversion, the image displayed in the Import Image dialog box is still compressed and may appear different from the actual display (after conversion).</p> <p>To cancel the conversion, simply click on the  button.</p>

PROCEDURE	REMARKS
<p>(4) Click on the  button. The Image screen's border will appear on the current screen.</p>  <p>(5) Click on the point where the Image screen is to be placed. The Image screen will appear on your screen.</p>	<p>To cancel the placement, click on the  icon.</p>



Note: If the Image screen(I) is placed outside the drawing area vertically, the portion of the image that does not fit in the drawing area will not be displayed on the GP screen. However, if the Image screen is placed outside the drawing area horizontally, the portion that does not fit will be squeezed so that it is displayed on the GP screen.

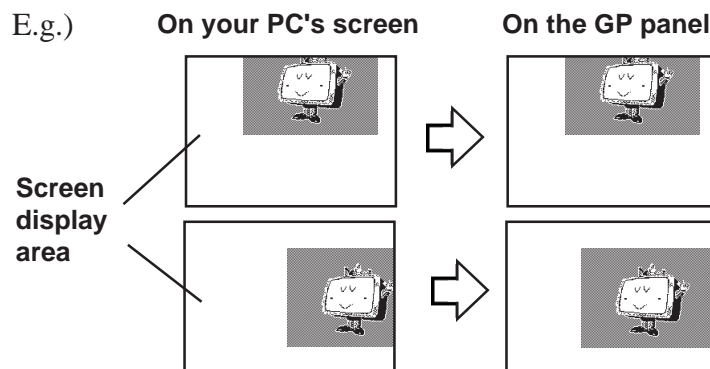

■ Pasting images with other file formats

The paste function can be used for images copied onto the Clipboard*¹. Executing the [Paste] command from screen editor while a copied image is in the clipboard will display the "Paste Image" dialog box on the screen. The "Source" tab will not be displayed on the screen. When images cannot be pasted with this procedure, convert the images into bitmap files or JPEG files with other image processing software before copying and pasting it to the screen editor.

*1 The clipboard is a storage location where copied or cut data is temporarily stored. The data stored on the clipboard can be copied or moved by pasting it.

2.3 Tags

Tags are one of the GP-PRO/PBIII for Windows program’s many powerful features. When you create a Tag, you can transform a square on the screen into a switch, or create an animated display that changes according to data from the Host PLC. Tags are created and placed on the screen where you want a function to be; and, while most of the applications for Tags are on a Base screen, they can be used with Keypad screens, as well as a variety of other screens.

Here, topics such as Previously Created Tags, Changing of Tags, and Deleting Tags, are discussed.

For further details of tags, refer to the Tag Reference Manual.

■ Points to Consider when Creating Tags

When creating a Tag, please be aware of the following points:

- ◆ When creating a number of tags on identical screens, if one Tag’s position overlaps that of another Tag, the Tags will overlap when they are called up and may not be displayed correctly. Please be aware of this when loading (calling up) multiple Tags.
- ◆ Using the Copy or Paste functions to place Tags with the same name on similar screens can make identifying Tags difficult. It is suggested that you either change the Tag’s attributes (i.e. name) directly, or use the Tag Summary to change the name. When 2 or more K Tags have been used to operate a common Trigger Bit, it is especially important that the Tag names used are different.

▼ Reference ▲ *Tag Reference Manual 2.12 K-tag (Key Input)*

- ◆ The maximum number of tags designated on the same screen is as follows. This total includes tags on any screens that have been called up, or are included in a window that is used. The figure below, however, does not include any k tags or R tags.

GP Series	GP-470 GP-570 GP-675	GP-270 GP-370 GP-H70	GP-377 GP77R GP2000
Number of tags	256	128	384

Refer to the figure below for the enabled tags.

<Example: when using GP-470>

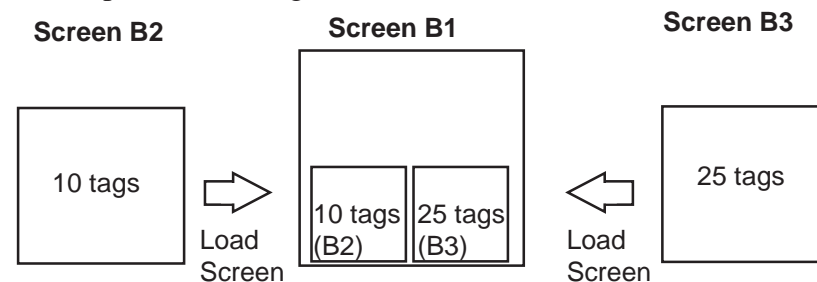

Combined number of Tags = 10(B2) + 25 (B3) + 30(B1) = **65** ≤ 256

Number of tags can be viewed from the Screen Information in GP-PRO/PBIII.

- ◆ Though all of a Tag's identifying marks, lines, etc. can be seen on the screen that it was created on, after that Tag's screen is called up to a Base screen, those Marks can no longer be seen and it can not be edited. In example 1 above, even though screen tags B2 and B3 are added to B1's total tag count, their identification data is not displayed on B1 (Drawing area, Tag List, etc.) and can not be edited from that screen. To edit these Marks, call up the Base screen on which each Tag was specified.
- ◆ The order in which each Tag is created is recorded, and when the total tag count for that screen exceeds 256 (Digital's GP-H70, GP-270 and GP-370 count up to 128 tags. GP-377, GP37W2, GP-377R, GP77R and GP2000 can use up to 384 tags.), those excess tags are ineffective. When the tags used on a screen have been called up from a window, those tags are added to the total, in the order that the window was called up. Thus, when calling up multiple windows for use on a screen, be sure that the total number of tags used in all the windows does not exceed the above limit, or certain tags will become invalid.
- ◆ Approximately 90 reserved tags are used for the Device Monitor function. When using Device Monitor together with regular screen tags, they must be added to the screen's total tag count. Thus, be sure that the tags used for the Device Monitor are included in your tag count calculation. If the total becomes greater than that screen's limit, the message "Total No. of Tags is over limit." will appear. Until the number of tags is reduced, there is a possibility that the Device Monitor function will not work correctly. If using the Device Monitor function will cause a screen's total tag count to exceed its limit, you should not use Device Monitor function on that screen.

Reference  **4.8 Device Monitor**

- ◆ The actual amount of space required (in bytes) for each tag will vary. When placing tags on a screen, please consider the number of tags that have already been created, the size of each tag, and the panel's tag limit. Information such as the current screen capacity and number of tags used can be viewed in the [Screen Information] dialog box.

Reference  **4.5.2 Screen Information**

For each tag size, refer to the following table.

<Tag Size List>

Tag Name	Function	Tag Size (Byte)
A	Alarm Summary Text Display	56
a	Alarm Summary Display	34
C	Clock Display	28
D	Statistic Graph Display	48
d	Statistic Data Display	74
E	Numeric Data Display extended function	32 to 122
F	Free Library Display	42
G	Graph Display	40
g	Graph Display extended function	38 to 158
H	Drawing Object Display	42
J	Moving Mark Display	38
K	Key Input	46, 58
k	Keypad Setup	28
L	Library Display	34
I	Library State Display	40 to 102
M	Mark Display	34
N	Numeric Data Display	36
n	Alarm Boundary Display	30
P	Numeric Display in Predefined Format	118
Q	Alarm Summary Display extended function	46, 66, 98
R	Rail Settings	20
S	String Display	32
T (including Tih, Tiw)	Touch Panel Input	36
t	Selector Switch Input	56
U	Window Display	34
V	Video Window Display	30
v	Video Window Extended Features	42
W	Write to a Device	32
X	Text Data Display	40

Be aware of the following points:

- The total number of t-tags that can be used on the GP-470, 570, 571, 675 and 870 is 128; with the GP-270, 370, and H70, it is 64; with the GP-377, GP-37W2, GP77R and GP2000 series, it is 192.
- Only one (1) A, a, and C- tag can be used per screen.
- A total of 30 R tags are possible on one screen. The total number of points used for R-tag data can be up to 406 per screen. However, when calling up multiple screens, the total points allowable is 512.
- The number of windows that can be displayed on one screen at one time is up to 3, i.e. one global window and two local windows via the U-tag.
- Tih, and Tiw tags cannot be used on the GP-H70, GP-270, GP-370, GP-57J, GP-377, GP-37W2, GP-377R and GP2000 series units, since they do not have AUX I/F Touch Switch output (TSW0 to 7).

2.3.1 Designating Tags

The tag setting items will differ depending on each tag type. Here, the basic setting procedures are described.

After a Tag is selected, that tag's dialog box will appear. Here all the tag's attribute data, such as the setting address, are entered. After all of the Tag's attributes have been entered, click on the button and designate the point or area on the screen where the Tag will function.

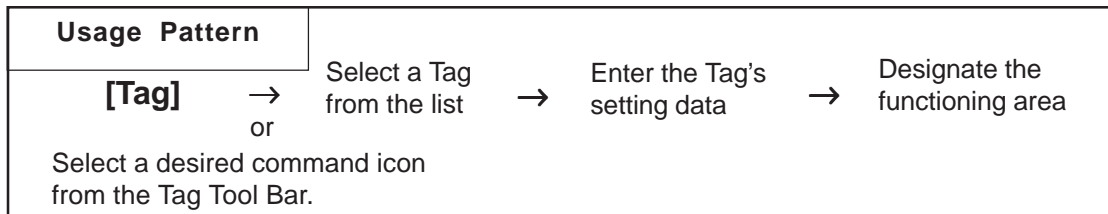

■ Tag Settings

An example of a Tag's dialog box is shown below.

In the [General Info] area, the Tag's name and description data are entered. Also, the Tag's general settings are displayed.



E.g.) L Tag

The actual setting items displayed will differ, depending on the tag.

▼ Reference ▲ *Tag Reference Manual*

■ Setting up Tags

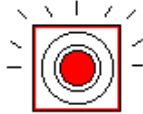

An example of an L tag's setting procedure is shown below.

GP-PRO/PBIII Tag Settings	PLC	GP Display
Tag Name	Lamp L1	
Display Mode		
Bit Address	M0016	
Designated Screen	Direct: 300 When M0016 is on...	the Lamp is on.
Erase Mode	Yes	(When M0016 is off, the Lamp is off)

In order to show a Lamp's ON and OFF states on the screen, the above mentioned settings will be used to create a lamp and its ON image.

- (1) In preparation, draw a lamp on the screen where the Tag will be positioned.
- (2) Draw an image of the lamp's lighting area on screen B300 (This image will be loaded onto the screen's center point. Create the image based on this center mark)

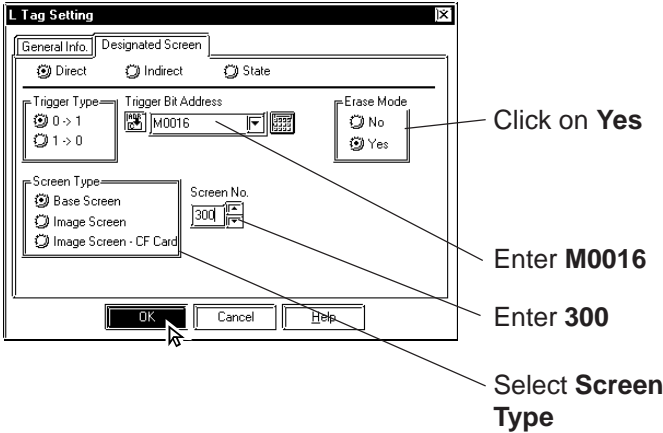
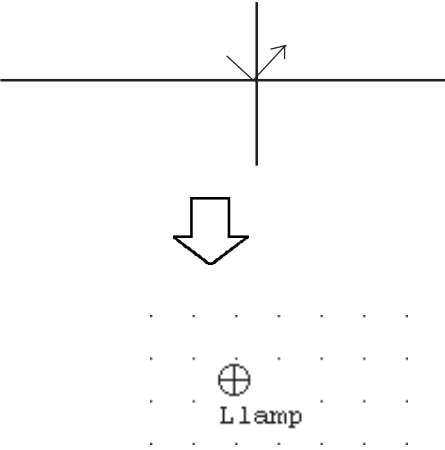
PROCEDURE	REMARKS
<p>(1) Select the [Tag] menu - [L-tag] command, or click on the  icon.</p> <p>(2) Enter the tag's name. If desired, enter a description.</p> <div style="display: flex; align-items: center;"> <div style="border: 1px solid black; padding: 5px; margin-right: 10px;"> <p>L Tag Setting</p> <p>General Screen Access</p> <p>Tag Name: L lamp 1</p> <p>Description: set up now lamp</p> <hr/> <p>Word Address: ----</p> <p>Bit Address: X00000</p> <p>Trigger Mode: 0 -> 1</p> <p>Screen Access: Direct</p> <p>Screen No.: Base : 1</p> <hr/> <p>Erase Mode: No</p> <p>OK Cancel Help</p> </div> <div> <p>Enter lamp 1</p> <p>Enter set up now lamp</p> </div> </div>	<p>A Tag name should be 5 characters or less.</p> <p>Reference <i>Tag Reference Manual; 2.14 L-tag (Library Display)</i></p>

PROCEDURE	REMARKS
<p>(3) Enter the required data in the [Designated Screen] area and click on the  button to register it.</p>  <p>(4) Click on the point where the tag is to be used. How this point is designated will differ depending on each Tag type.</p> 	<p>If your GP type is the GP77R or GP2000 series, [Image Screen - CF Card] can be selected in the [Screen Type] section.</p> <p>Use the pull down menu [Option]'s [Screen Property] command to change the Tag name, setting address, and Tag mark display state (i.e. displayed or not displayed). (However, these settings will not be displayed on the GP screen.)</p> <p>Reference 2.8.2 Screen Property Settings</p> <p>To cancel the placement, click on the  icon.</p> <p>Double-clicking on any Tab registered on the screen automatically calls up that Tag's attribute settings.</p> <p>Reference 2.4.14 Changing Attributes</p>





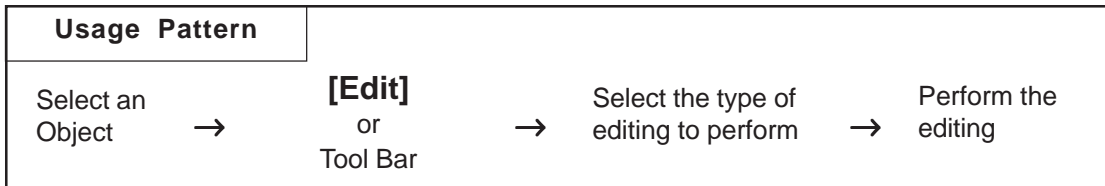











2.4 Object Editing

Parts, objects, text, and Tags previously placed or drawn (hereafter called “Objects”), can be edited using various functions, such as Copy and Delete. To edit an object, first, use the cursor to select the object, and then select the type of edit operation.



■ Types of Editing Functions

Icons contained in the Edit Tool Bar and their corresponding edit operation are as follows:

Icon	Edit Type	Icon	Edit Type
	Undo		Group
	Redo		Ungroup
	Cut		Bring to Front
	Copy		Send to Back
	Paste		Change Attribute
	Command Data Paste ^{*1}		Change Coordinates
	Duplicate		Vertex Editing
	Delete		Transferring Screen to Clipboard
	Align		Converting Screen to Bitmap File
	Rotate Left		Redraw Screen
	Rotate Right		Select All
	Mirror X-axis		Select
	Mirror Y-axis		



Some of the editing tools listed above can be selected from the menu displayed on the screen by right-clicking the mouse.

**1 This function is enabled only when GP Type selection is a GLC series unit.*

Reference Pro-Control Editor Operation Manual

2.4.1 **Selecting Objects**

Two methods are available for selecting objects: 1) clicking on an object directly, or 2) dragging the mouse to enclose and select single or multiple objects.

Also, you can select individual objects that have other objects either on top of, or overlapping them.

When the tool bar's  icon is clicked on (active), an object can be selected. To activate this icon, click on it directly, or select the pull down [Edit] menu's [Select] command. Also, while drawing objects, right-clicking anywhere on a desired object allows you to select it.

Either a or a mark will be displayed on the sides of the selected object. These square marks are called "handles".

Handle Types

There are two types of handles, those that can be used to scale the object and those that can not. Refer to 2.4.3 Scaling Up/Down

- : Can be used to scale the object
- : Cannot be used to scale

When an object has been selected, the Selection Tool box will automatically appear. When multiple objects are selected, all the selection Tool box's functions are available.

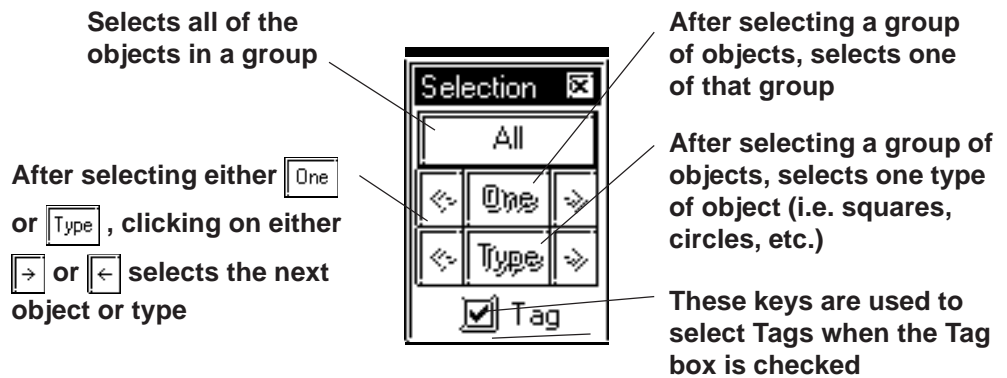

The diagram shows a 'Selection' tool box with the following callouts:

- Selects all of the objects in a group**: points to the 'All' button.
- After selecting either One or Type, clicking on either or selects the next object or type**: points to the 'One' and 'Type' buttons and their respective left and right arrow buttons.
- After selecting a group of objects, selects one of that group**: points to the 'All' button.
- After selecting a group of objects, selects one type of object (i.e. squares, circles, etc.)**: points to the 'One' and 'Type' buttons.
- These keys are used to select Tags when the Tag box is checked**: points to the 'Tag' checkbox.

Note: Objects may be selected using the Screen Data List, instead of selecting them on the screen.

Reference 2.8.4 Screen Data List

- When the tag check box for the selection tool box is marked with a check, tags can be selected even if the tag names and marks are hidden.

■ **How to Select a Single Object**

Here, the procedure for selecting an object is explained.

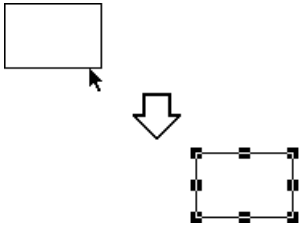
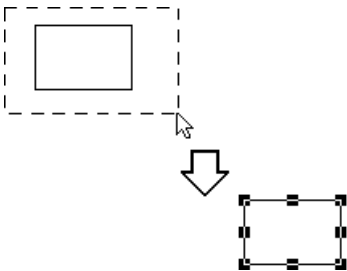
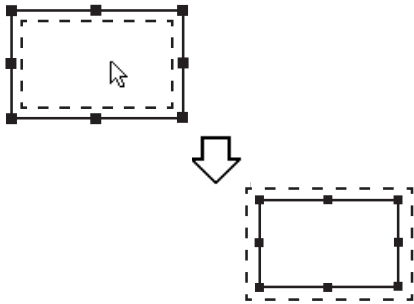

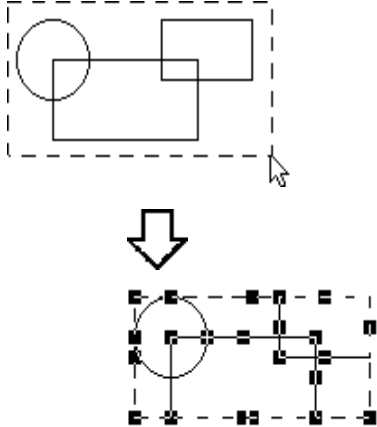
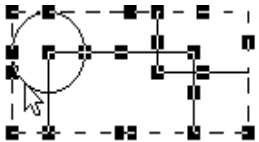

PROCEDURE	REMARKS
<p>[Selecting an Object Directly]</p> <p>(1) Move the cursor over the object, and left-click. Handles display on the object to show that it is selected.</p> 	<p>To select a Tag, check the [Option] menu's [Screen Property] command's Tag Mark check box beforehand.</p> <p>When selecting grouped objects, click on any one of the objects in a group to select the group.</p>
<p>[Selecting an Object by Dragging]</p> <p>(1) Position the cursor near the object and hold the button down, then drag(this is called "Left-dragging") the mouse over the object. As you do so, a "box" formed by a dotted line will expand to enclose the object. When the entire object is enclosed within the "box", release the mouse button; handles display on the object to show that it has been selected. You must position the cursor relative to the object so that when you Left-drag over it, the entire object will be enclosed within the "box"; if it is not, then the object will not be selected. This method is most useful when selecting multiple objects, described below.</p> 	<p>A Part's Label can be selected independently from the Part.</p> <p>Click on a Part to display its handles and then on its Label to display the Label's handles. After selecting the Label, it can be moved or scaled independently from the Part.</p> <p>Numeric Display and text can also be selected using the above-mentioned steps.</p>
<p>[Selecting an Object from Overlapped Objects]</p> <p>(1) While holding down the [Ctrl] key, click on an Object to be selected. That Object's handles will appear to reveal it has been selected.</p> 	<p>Left-dragging over only a part of the object will not select it. The entire object must be enclosed to select it.</p> <p>When you wish to select another object without de-selecting the previous one, hold down the [Shift] key while making the next selection. This can also be done continually to select multiple objects.</p>

■ How to Select Multiple Objects

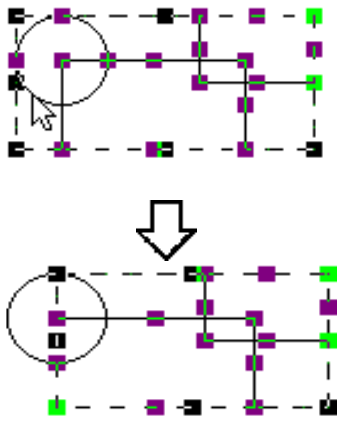
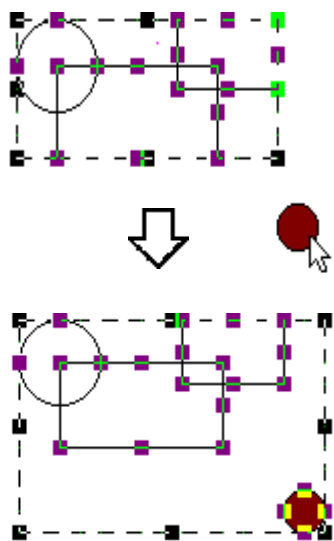
Use this operation to select multiple objects. All the objects in a designated area or on the entire screen can be selected. Also, if necessary, some of these objects can be de-selected.

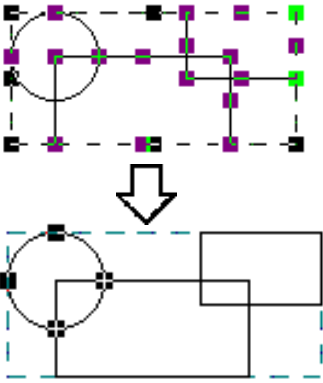
PROCEDURE	REMARKS
<p>[Selecting Multiple Objects by Dragging]</p> <p>(1) Left-drag over objects as described in Selecting an Object by Dragging (see above). Be sure to enclose all of the objects to be selected completely; if part of an object is not enclosed within the “box”, it will not be included in the multiple selection. Handles will display on the objects that have been selected.</p>  <p>[Selecting All the Objects on a Screen]</p> <p>(1) Select the pull down [Edit] menu’s [Select All Objects] command. All object handles will appear, to show that they have been selected.</p> 	<p>To select a Tag, check the [Option] menu’s [Screen Property] command’s Tag Mark check box beforehand.</p> <p>Left-dragging over only a part of an object will not select it. The entire object must be specified to make selection possible.</p> <p>When two or more objects are selected, the [Change Attributes] command cannot be used.</p> <p>The editing commands available depend on what objects have been selected.</p>

PROCEDURE	REMARKS
<p>[Excluding Objects From A Multiple Selection]</p> <p>(2) When multiple objects are selected, to de-select an object while preserving the selection of the other objects, first move the cursor over the object; then, while holding down the Shift key, left-click on the object. When the object's handles disappear, that object is no longer selected. Repeat this process as many times as desired.</p>  <p>[Adding Objects To A Multiple Selection]</p> <p>(2) When multiple objects are selected, to add an object, either left-click on the object or Left-drag over it, while holding down the Shift key. The imaginary “box” that encloses the multiple selection (represented by its own handles) will expand to include the added object, which now has handles. Using this process, you can add as many objects to the multiple selection as you want.</p> 	

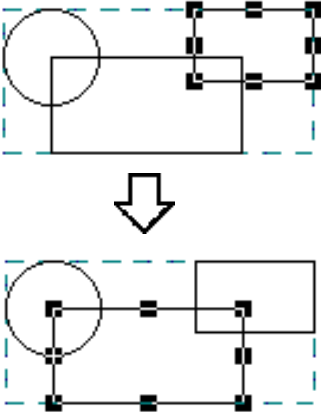
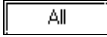

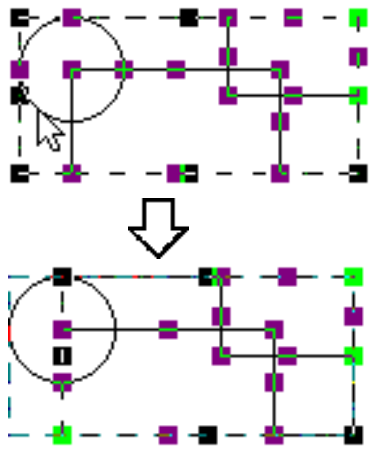
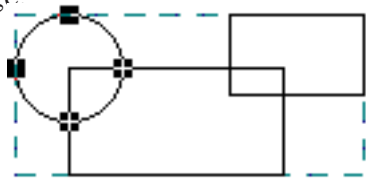



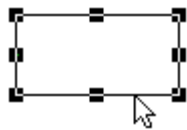

PROCEDURE	REMARKS
<p>[Selecting One Object in a Multiple Selection]</p> <p>(2) First, make a multiple selection; then, click on the Selection Tool box's  icon. All the objects in the multiple selection will become de-selected, except for one.</p>  <p>(3) Use the  and  icons to “scroll” through all the objects originally in the multiple selection; clicking on these arrow keys will change the selected item, one at a time. Clicking on the  icon will select the next object, and clicking on the  icon will select the previous object, in the order that they were drawn.</p> 	<p>If you wish to re-select all the objects originally in the multiple selection, click on the Selection Tool box's  button.</p> <p>To select an Object from overlapped Objects.</p> <p>▼ Reference ▲ ■ How to Select a Single Object</p>

PROCEDURE	REMARKS
<p>[Selecting Objects by Type from a Multiple Selection]</p> <p>(2) First, make a multiple selection; then, click on the Selection Tool box's <input type="text" value="Type"/> icon.</p> <p>Selection handles will appear for only one type of object (here, only square objects are selected), while an outline remains around them all. This will effectively de-select any objects that are not the currently selected type.</p>  <p>(3) Use the <input type="text" value="←"/> and <input type="text" value="→"/> icons to select a different object type.</p> <p>As you press either arrow key, the selected object type will change.</p> 	<p>Objects are classified as follows: Parts: by each type, Objects: by each type, Tags: All as one type, Loaded Screens and Marks: All as one type, respectively.</p> <p>To re-select all the objects originally in the multiple selection, click on the Selection Tool box's <input type="text" value="All"/> button.</p>

2.4.2 Moving Objects

In this section, the procedures for moving objects are described.

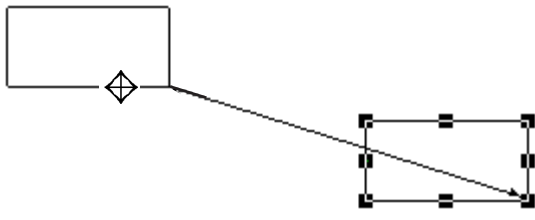
■ How to Move an Object

PROCEDURE	REMARKS
<p>(1) Click on the desired object. The object's handles will appear, showing that it has been selected.</p> 	<p>Reference 2.4.1 <i>Selecting Objects</i></p> <p>The keyboard's , , , and  keys can also be used when the object's handles are displayed.</p>
<p>(2) Place the cursor over the object, away from the handles, and after the cursor changes to , drag it to the desired location.</p> 	<p>If an object is too small to select and move (i.e. it is only scaled up or down), click on and drag the object while holding down the  key.</p> <p>Also, you can move the object by zooming out the screen or using the keyboard.</p> <p>Reference 1.3.2 <i>Display Area (50%, 100%, 200%)</i></p> <p>To cancel the movement, click on the  icon.</p>





- To move an object horizontally or vertically, do so while holding the [Shift] key down. In this case, the object will be moved in either the horizontal or vertical direction where the moving distance is greater.
- To move and scale up/down an object, designating its coordinates can be used.

Reference 2.4.15 *Changing Coordinates*

2.4.3 Scaling Up/Down

Scaling means changing the size and proportion of an object. This function allows you to easily scale an object up (larger) or down (smaller). Be sure the object's handles are displayed as (■).

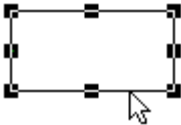
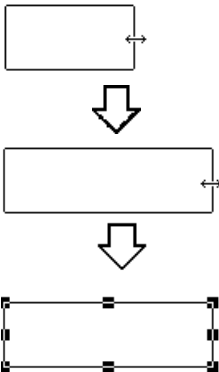
■ **Scaling An Object**

PROCEDURE	REMARKS
<p>(1) Click on the object to select it. The object's handles will appear to show that it is selected.</p>  <p>(2) Place the cursor on an object's handle, and after the double arrow cursor appears, drag the handle to re-size the object.</p> 	<p>Reference 2.4.1 <i>Selecting Objects</i></p> <p>Re-sizing will depend on which handle is dragged:</p> <p>Ex. To scale a square up or down: Corner Handles = proportionally Top/Bottom handles = vertically Right/Left handles = horizontally</p> <p>Place the cursor on one of the handles of the object. When the cursor becomes ↔, use the keyboard's either ↑, →, ←, or ↓ key to scale the object up or down in the unit of dot.</p> <p>To cancel the re-sizing, click on the  icon.</p>







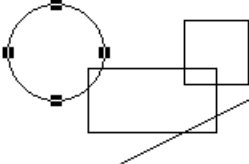

- When re-sizing an object while holding down the **[Ctrl]** key, lines will snap to 45 degree intervals, Rectangular and Scale (Linear) objects will become square-shaped objects, and ovals will become circles. Also, if the **[Shift]** key is held down, all selected Lines, Rectangles, Ovals, Scales, Text and loaded Marks will scale up or down proportionately.
- When scaling a Part with a Label, holding down the **[Ctrl]** key causes the Label to scale up or down together with the Part.
- When selecting an oblique line, 8 handles will be displayed. Click on the line again and 8 handles will change to 2 handles, one at either end. Clicking and then dragging on one end's handle "fixes" the opposite end in place, and "releases" the dragged end, and allowing the line to pivot freely.
- Multiple parts may be selected and then scaled up/down. However, the following parts are not scaled up/down, but their positions are moved:
- Half-pie Graphs, Pie Graphs, Meters, Trend Graphs, Alarms, Keypads, and Picture Displays.
- To move and scale up/down an object, designating its coordinates can be used. **Reference** 2.4.15 *Changing Coordinates*
- When scaling the text with the Image Font, the text alone may exceed the scaling range.

2.4.4 **Cut**

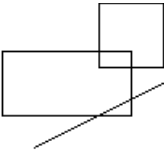
Here, the procedure for “cutting” an object (deleting it) and placing it on another screen, is explained. The object can also be placed elsewhere on the same screen, instead of using the Move procedure described in section 2.4.2. In addition, an object can simply be “cut” (deleted), and not placed anywhere. (When an object is “cut”, it is stored in the Clipboard*1.)

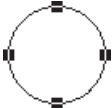
■ Cutting (Moving) an Object





PROCEDURE	REMARKS
<p>(1) Select an object.</p> 	<p>Reference 2.4.1 <i>Selecting Objects</i></p>
<p>(2) Select the [Edit] menu - [Cut] command, or click on the  icon.</p> <p>Then, the selected object will be cut.</p> 	<p>To cancel the Cutting, click on the  icon.</p>
<p>(3) Open the object’s destination screen, and select the [Edit] menu - [Paste] command, or click on the  icon.</p> <p>Then, the outline of the object cut from the previous screen will appear.</p>	
<p>(4) Position the cursor and click on the point where the object is to be placed.</p> <p>The object that had been Cut from the previous screen will be “pasted” at the new location.</p> 	<p>To cancel the pasting, click on the  icon.</p>

*1 An area where text, graphics, or both, that have been Cut or Copied, are temporarily stored. The contents of the Clipboard can be “pasted” (copied from the Clipboard) using the Paste function. However, once the Copy/Cut command is executed, the data stored in the Clipboard is replaced; therefore, only the data from the most recent Copy/Cut command can be pasted.

2.4.5 Copy

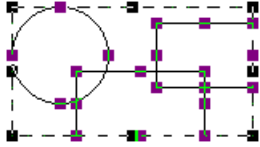
Here, the procedure for “copying” an object (without deleting it) and placing it elsewhere, is explained. (When an object is “copied”, it is stored in the Clipboard*1.)

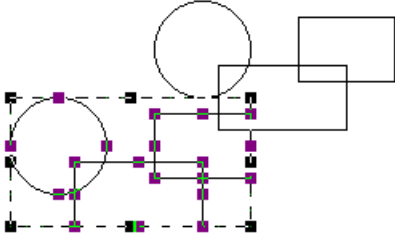
■ Copying an Object





PROCEDURE	REMARKS
<p>(1) Select the desired object(s).</p>  <p>(2) Select the [Edit] menu - [Copy] command, or click on the  icon. The selected object(s) will be Copied to the Clipboard.</p> <p>(3) Select the [Edit] menu - [Paste] command, or click on the  icon. Then, the outline of the object copied from the previous screen to the Clipboard will appear.</p> <p>(4) Position the cursor and click on the point where the object is to be placed. The object stored in the Clipboard will be Copied to the specified location.</p> 	<p>Reference 2.4.1 <i>Selecting Objects</i></p> <p>To cancel the Copying, click on the  icon.</p> <p>When “pasting” the Copied object on another screen, be sure to open that screen first.</p> <p>Selecting and dragging an object to another screen while holding down the [Esc] key can also be used to copy the object.</p> <p>To cancel the pasting, click on the  icon.</p>

*1 An area where text, graphics, or both, that have been Cut or Copied, are temporarily stored. The contents of the Clipboard can be “pasted” (copied from the Clipboard) using the Paste function. However, once the Copy/Cut command is executed, the data stored in the Clipboard is replaced; therefore, only the data from the most recent Copy/Cut command can be pasted.

2.4.6 Paste

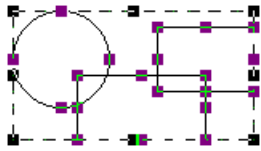
Here, the procedure for “pasting” an object, that has been Copied (or Cut) to the Clipboard*1, is explained.

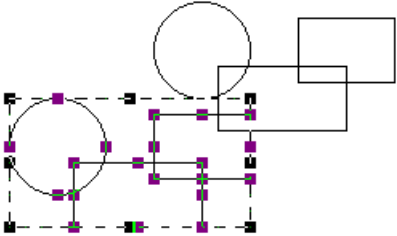
■ Pasting an Object

PROCEDURE	REMARKS
<p>(1)First, Copy (or Cut) an object.</p>  <p>(2)Select the [Edit] menu - [Paste] command, or click on the  icon.</p> <p>Then, the outline of the object copied from the previous screen to the Clipboard will appear.</p> <p>(3)Position the cursor and click on the point where the object is to be Pasted.</p> <p>The object stored in the Clipboard will be Pasted to the new location.</p> 	<p>Reference 2.4.5 Copy</p> <p>To cancel the paste, click on the  icon.</p> <p>When an object is copied from another screen, it will be automatically placed at the same coordinates as its original ones. To place the object at different coordinates, move it after this automatic placement.</p>

*1 An area where text, graphics, or both, that have been Cut or Copied, are temporarily stored. The contents of the Clipboard can be “pasted” (copied from the Clipboard) using the Paste function. However, once the Copy/Cut command is executed, the data stored in the Clipboard is replaced; therefore, only the data from the most recent Copy/Cut command can be pasted.

2.4.7 Duplicate

This command allows you to easily make multiple copies of any object. The address of the copies can be set up so as to increment automatically from copy to copy, or simply reuse the address of the original object.

■ Duplicate Setting Dialog Box

When this command is used, the Duplicate dialog box for entering the copy specifications, will appear as shown below.

The screenshot shows the 'Duplicate' dialog box with the following fields and options:

- Number of Copy:** Includes checkboxes for 'Columns' (set to 4) and 'Rows' (set to 3).
- Spacing:** Includes input fields for 'Horizontal' and 'Vertical' spacing, both set to 0, with '(Pixels)' labels.
- Address Increment:** Includes a checked 'Address Increment' checkbox, radio buttons for 'X-Direction' and 'Y-Direction', an 'Add Offset' field set to 1, and an 'Apply Device Comment' checkbox.
- Buttons:** 'OK', 'Cancel', and 'Help' buttons are present.

Annotations point to specific fields:

- 'Enter the number of copies in the X and Y directions' points to the 'Columns' and 'Rows' fields.
- 'Enter the line spacing, in dot units' points to the 'Horizontal' and 'Vertical' spacing fields.
- 'When copying Parts or Tags that require addresses, clicking here will automatically assign new, incremented addresses for each copy' points to the 'Apply Device Comment' checkbox.
- 'The device comment corresponding to an address assigned by the automatic address increment is reflected in the Description field.' points to the 'Apply Device Comment' checkbox.

◆ Number of Copies

Here, how many times an object will be copied in the X and Y directions is entered. When "1" is entered for either direction, copying will not be performed in that direction.

The number of copies is also limited by the copied object's location, size, the Duplicate dialog box's Spacing settings, and any other related settings.

◆ Spacing

Enter the spacing interval of dot (screen pixel) units to be used when the object is copied for both the Horizontal and Vertical directions.



Note: When Duplicating an object, its positioning will be decided based on the top left handle of the copied (master) object. However, if a Bar Graph's handles are located in a graph display area, the object will be placed based on the graph display area, not the graph's border. Therefore, when setting the spacing, be sure to not overlap any of the graphs' borders.

◆ Address Increment

To copy multiple tags and parts, specify the direction of the automatic address increment. According to the automatic address increment, consecutive Addresses will be assigned in the designated direction. When the original object's Address is a Bit Address, the automatic address increment is performed in the unit of bit, and when it is a Word Address, the automatic address increment is performed in the unit of word.

If the automatic address increment is not used, tags and parts will be copied using the same address as their original ones.

E.g.) When duplicating with the settings shown below:

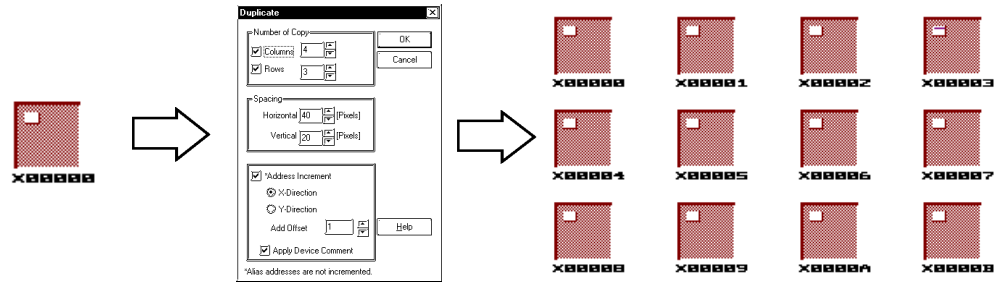



◆ Reflection of Device Comments

When the [Apply Device Comment] check box is marked with a check, the device comment corresponding to an address assigned by the automatic address increment will be reflected in the Description Field. For tags designating multiple Addresses and Parts, however, the device comment corresponding to an Address designated as the Reflected Description Address is reflected. The Reflected Description Addresses for different tags and parts are shown in the table below:

<Reflected Description Address Table>

Object name	Automatic input address	Object name	Automatic input address	Object name	Automatic input address
A-tag	Monitor word address	P-tag	Word address	Bit Switch	Operation bit address
a-tag	Monitor word address	Q-tag		Word Switch	Word address
C-tag		R-tag		Function Switch	
D-tag	Word address	S-tag	Word address	Toggle Switch	Operation bit address
d-tag	Word address	T-tag (bit)	Bit address	Lamp	Bit address
E-tag	Word address	T-tag (word)	Word address	4-state Lamp	Lamp Address 1
F-tag	Word address	T-tag (special)		Bar Graph	Word address
G-tag	Word address	t-tag	Bit address	Pie Graph	Word address
g-tag	Word address	Tih-tag		Half-pie Graph	Word address
H-tag	Start bit address	Tiw-tag		Tank Graph	Word address
J-tag	Word address	U-tag	Word address	Meter Graph	Word address
K-tag	Word address	U-tag (high-speed)	Bit address	Trend Graph	Channel 0 word address
k-tag		V-tag		Keyboard	
L-tag (direct/indirect)	Start bit address	v-tag		Keypad Input Display	Word address
L-tag (without indirect start bit)	Word address	W-tag (bit)	Bit address	Alarm	Word address
L-tag (state)	Word address	W-tag (word)	Word address	File Name Display	
1-tag	Word address	W-tag (special)	Start bit address	Data Logging Display	Block number designated address
M-tag	Start bit address	X-tag (bit)	Bit address	Numeric Display	Word address
M-tag (without start bit)	Word address	X-tag (word)	Text screen word address	Message Display	Word address
N-tag	Word address	Trend channel	Word address	Date Display	
n-tag		Data sampling	Sampling address	Time Display	
				Graphic Display	Bit address
				Window Parts	Word address

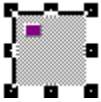
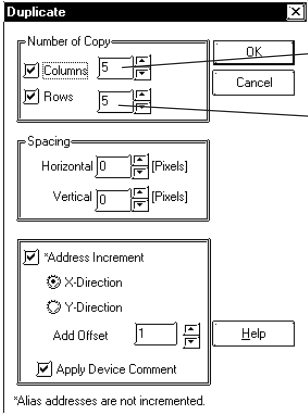
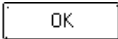
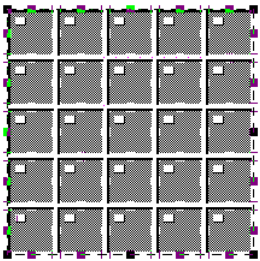

■ Duplicating

PROCEDURE	REMARKS
<p><When Duplicating a Switch 5 times in both the X and Y directions></p> <p>(1) Select the desired object.</p>  <p>(2) Select the pull down [Edit] menu's [Duplicate] command.</p> <p>(3) Enter the number of copies to make in the X and Y directions, spacing between copies. If desired, click on the Address Increment check box, to increment addresses automatically.</p>  <p>(4) Click on the  button to duplicate the object.</p> 	<p>When duplicating an object, positioning will be decided based on the top left handle of the copied (master) object.</p> <p>To cancel the duplication, click on the  icon.</p> <p>To stop duplicating, press the  key.</p>

2.4.8 Delete

Here, the procedure for deleting an object is explained.

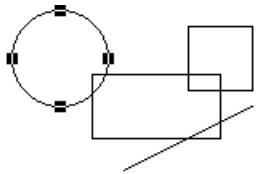
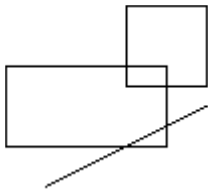
■ **Deleting an Object**

PROCEDURE	REMARKS
<p>(1) Select an object.</p>  <p>(2) Select the pull down [Edit] menu's [Delete] command.</p> 	<p>Instead of selecting the [Delete] command, the computer keyboard's Delete key can also be used.</p> <p>To cancel the deletion, click on the  icon.</p>



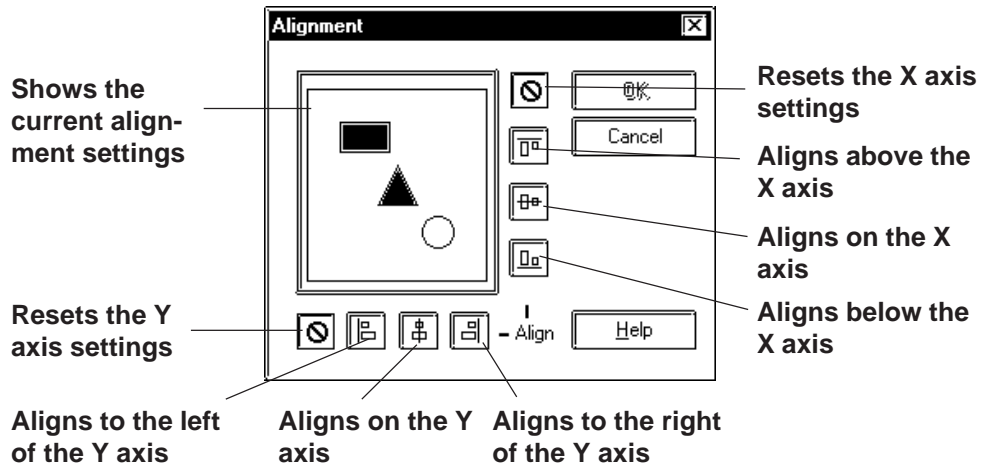

2.4.9 **Align**

Here, the procedure for aligning and centering object(s) are explained.

■ **Alignment Dialog Box**

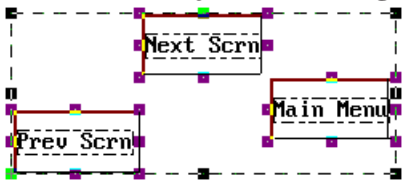

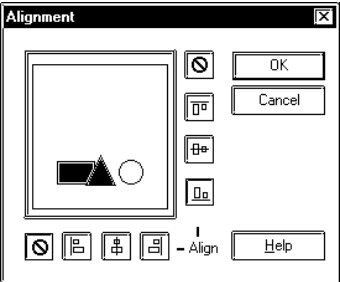
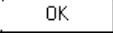
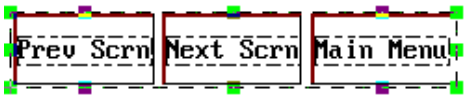



■ **Aligning Object Positions**

PROCEDURE	REMARKS
<p>(1) Select all the desired objects to be aligned.</p>  <p>(2) Select the [Edit] menu - [Align] command, or click on the  icon.</p> <p>(3) Select the type of alignment from the Alignment dialog box. In this example, select the  icon (X-axis: Bottom) and do not select any vertical (Y-axis) position.</p>  <p>(4) Click on the  button to align the objects.</p> 	<p>Reference 2.4.1 <i>Selecting Objects</i></p> <p>While an individual label can be aligned, groups of labels cannot. (Click on an object to select its handles and then click on its Label to select the Label's handles.) Text characters on both Numeric or other types of Displays can be aligned in the same manner.</p> <p>To align objects, combine the selections shown below:</p> <p>Horizontal position: Up, Center, Bottom</p> <p>Vertical position: Left, Center, Right</p> <p>To cancel the alignment, click on the  icon.</p>



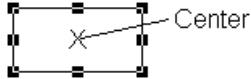

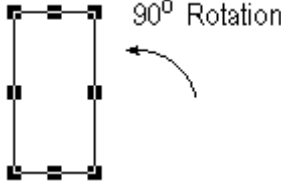
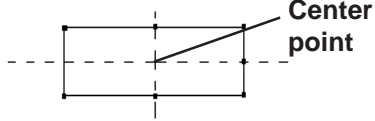
2.4.10 Rotate Left/ Rotate Right

With this command, an object can be rotated in 90° increments. However, loaded Screens and Marks, some Tags, and grouped objects cannot be rotated.

■ Rotating an Object Counterclockwise (Left)

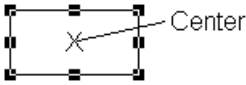
PROCEDURE	REMARKS
<p>(1) Select an object.</p>  <p>(2) Select the [Edit] menu - [Rotate Left] command, or click on the  icon.</p> <p>The object will be rotated counterclockwise 90 degrees, relative to its center point; if necessary, repeat the command.</p> 	<p>Reference 2.4.1 <i>Selecting Objects</i></p> <p>The center point of the object is where two lines, connecting the opposite handles (other than the corner handles), cross.</p>  <p>To cancel the rotation, click on the  icon. (Clicking on the  icon one time reverses one 90 degree rotation.)</p> <p>If an object is moved outside the drawing area by rotating, the object will not be displayed on the GP screen.</p>

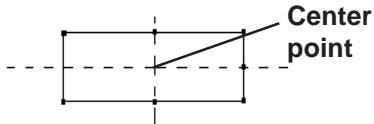





■ Rotating an Object Clockwise (Right)

PROCEDURE	REMARKS
<p>(1) Select a desired object.</p>  <p>(2) Select the [Edit] menu - [Rotate Right] command, or click on the  icon.</p> <p>The object will be rotated clockwise 90 degrees, relative to its center point. If necessary, repeat the command.</p> 	<p>Reference 2.4.1 <i>Selecting Objects</i></p> <p>The center point of the object is where two lines, connecting the opposite handles (other than the corner handles), cross.</p>  <p>To cancel the rotation, click on the  icon. (Clicking on the  icon once reverses one 90 degree rotation.)</p> <p>If an object is moved outside the drawing area by rotating, the object will not be displayed on the GP screen.</p>

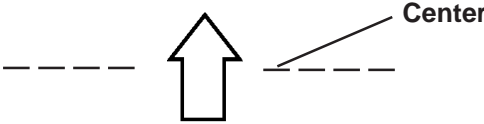

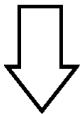
2.4.11 Mirror X/ Mirror Y

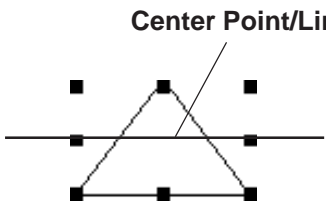
An object can be moved symmetrically around its center line with respect to the X or Y axis. The display position of Tags, Parts, Text, Load Screens, and Load Marks can only be moved symmetrically.

■ Moving Symmetrically along the X-axis

PROCEDURE	REMARKS
<p>(1) Select an object.</p>  <p>(2) Select the [Edit] menu - [Mirror X-axis] command, or click on the  icon.</p> <p>The object will move symmetrically with respect to the X-axis.</p> 	<p>Reference  2.4.1 <i>Selecting Objects</i></p> <p>The center point of the object is where two lines, connecting the opposite handles (other than the corner handles), cross.</p>  <p>If an object is moved outside of the drawing area by using the Mirror X function, the part of the object outside the drawing area will not be displayed on the GP screen.</p> <p>To cancel the change, click on the  icon.</p>

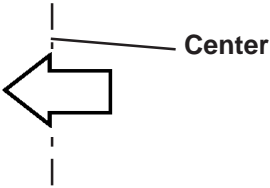

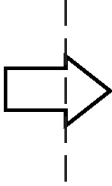
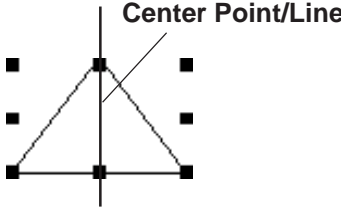
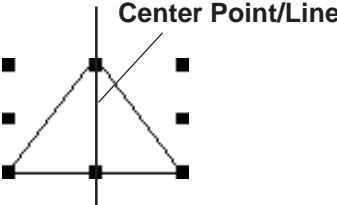

■ Moving Symmetrically along the Y-axis

PROCEDURE	REMARKS
<p>(1) Select an object.</p>  <p>(2) Select the [Edit] menu - [Mirror Y-axis] command, or click on the  icon.</p> <p>The object will move symmetrically around the Y axis.</p> 	<p>Reference 2.4.1 <i>Selecting Objects</i></p> <p>The center point of the object is where two lines, connecting the opposite handles (other than the corner handles), cross.</p>  <p>If an object is moved outside of the drawing area by using the Mirror Y function, the overflowing part of the object will not be displayed on the GP screen.</p> <p>To cancel the change, click on the  icon.</p>

2.4.12 Group/Ungroup

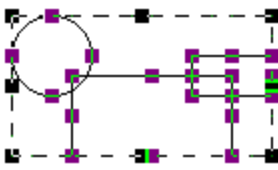
This function can be used to “group” multiple objects, enabling you to manipulate the “group” as a single object, even after changing screens or using a different editing function.

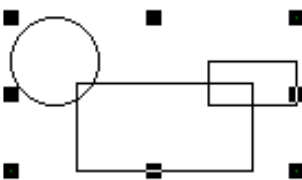
■ Grouping Objects





PROCEDURE	REMARKS
<p>(1) Select the objects to be Grouped.</p>  <p>(2) Select the [Edit] menu - [Group] command, or click on the  icon.</p> 	<p>Reference  2.4.1 <i>Selecting Objects</i></p> <p>To cancel the Grouping, click on the  icon.</p>

- Note:**
- When a Part is included in a group, its handles appear as , so that the individual Part cannot be scaled up/down independent of the group. Thus, you must first ungroup the objects in order to scale any individual object.
 - When a Part is included in a group, double click on the group to bring up the Confirm Device Address dialog box, where address changes can be made.

Reference  2.4.14 *Changing Attributes*

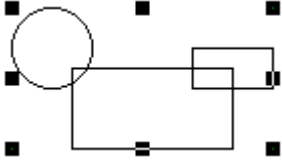
■ **Ungrouping Objects**

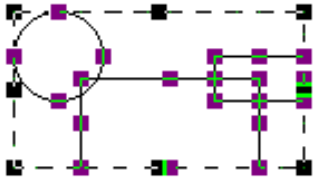







This function changes a Group of objects to a selection of multiple objects.

PROCEDURE	REMARKS
<p>(1) Select a group of objects.</p>  <p>(2) Select the [Edit] menu - [Ungroup] command, or click on the  icon.</p> 	<p>Reference 2.4.1 <i>Selecting Objects</i></p> <p>To select a group including tags, place a check mark in the Tag check box in the Select Tool Box.</p> <p>To cancel the ungrouping, click on the  icon.</p>

2.4.13 Bring to Front/ Send to Back

When graphics and Parts overlap each other, you can change the order of the layers with these two commands.







■ Changing the Order of Overlapping Objects

PROCEDURE	REMARKS
<p>In this example, you will move the oval, partially hidden by the rectangle, to the front.</p> <p>[Bringing an Object Forward]</p> <p>(1) Use the cursor to select the filled oval.</p>  <p>(2) Select the [Edit] menu - [Bring to Front] command, or click on the  icon.</p>  <p>[Sending an Object Behind]</p> <p>(1) Use the cursor to select the black rectangle.</p>  <p>(2) Select the [Edit] menu - [Send to Back] command, or click on the  icon.</p> 	<p>Reference 2.4.1 <i>Selecting Objects</i></p> <p>To cancel the movement, click on the  icon.</p> <p>To cancel the movement, click on the  icon.</p>

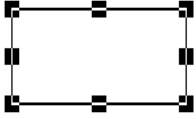
2.4.14 Changing Attributes

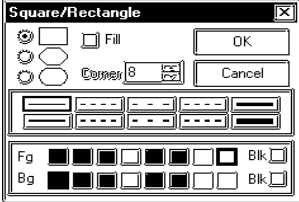
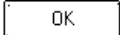
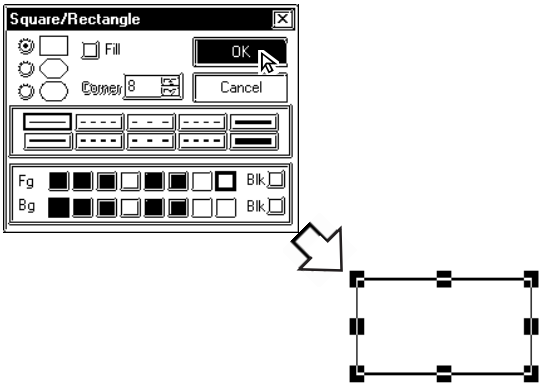
Here, you can change any of an object's attributes, i.e. its color, address, etc. Also, with objects of the same type, you can change the same attribute of all the objects of that type at the same time.

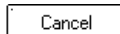
■ Changing Attributes

PROCEDURE	REMARKS
<p>(1)First, select an object, to change its' attributes. In this case, an unfilled rectangle drawn with a solid line.</p>  <p>(2)Select the [Edit] menu - [Change Attribute] command, or click on the  icon.</p> <p>(3)Select a new attribute from the dialog box. Here, a dotted line is selected.</p>  <p>(4)Click on the  button to register your change.</p> 	<p>Reference 2.4.1 <i>Selecting Objects</i></p> <p>While the attributes of Grouped objects generally, cannot be changed, the same type objects can be changed at the same time. When Grouped Parts have been selected, only their addresses can be changed.</p> <p>Reference ■ <i>Confirming Addresses</i></p> <p>Instead of clicking on the  icon, simply double-click on the object when selecting it, to display the Attribute Settings dialog box (skip step {2}).</p> <p>To cancel the attribute changes, click on the  button in the dialog box.</p> <p>Even after clicking on the , you can reverse the attributes changes (only for the most recent change) by clicking on the  icon.</p>

Note: You can select more than one object of the same type and change the attributes of each, at the same time. With all the desired objects selected, click on the Tool box's  button; then, proceed with step (2).

Reference 2.4.1 *Selecting Objects*, ■ *How to Select Multiple Objects*, [*Selecting Objects by Type from a Multiple Selection*]

■ **Confirming Addresses**

If a Part that requires an address has been grouped, the Confirm Device Address dialog box shown below will appear whenever its attributes are changed; the Part addresses are changed here.

Allows you to view either the Bit or Word Addresses of all the Parts in the currently selected group of objects

Part Addresses are displayed here

Check this box to automatically change all the addresses of the Parts in this group that have the same Device Address

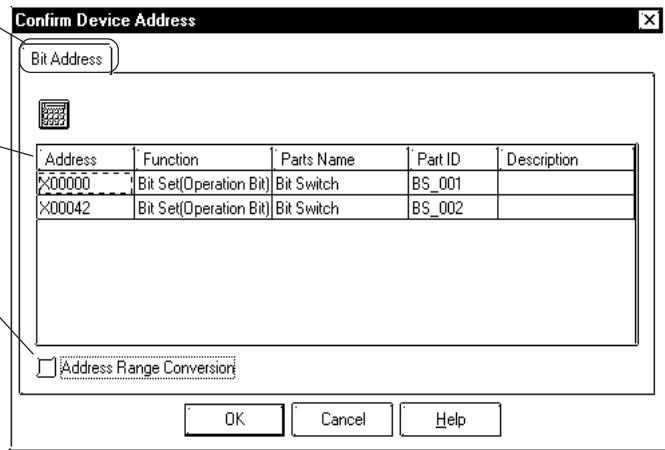

◆ **Bit and Word Addresses**

Each Part's address is displayed. To change an address, click on the inside of each cell. As shown above, any Switches selected that have state changes will have both their Operation Bit and their Monitor Bit addresses displayed.

◆ **Address Range Conversion**

When an address is changed and this check box is checked, any other Part with the same device address will be automatically changed.

In the example above, if the first bit address is changed from X00000 to X00010, the following bit addresses will be changed as below.

Clicking on any cell other than the changed one will show the changed address

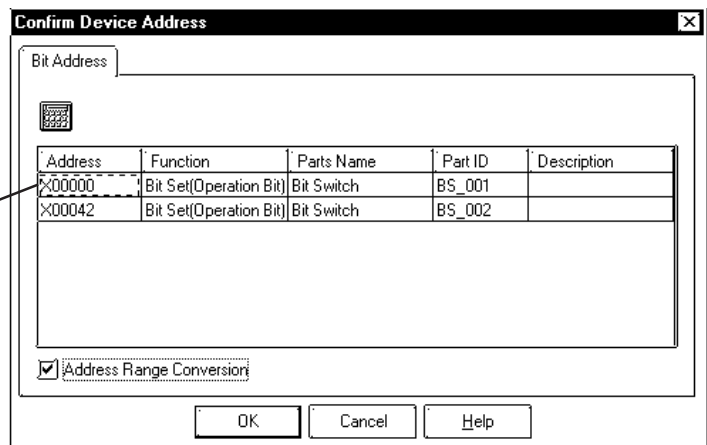

2.4.15 Changing Coordinates

Object positions and sizes can be changed by specifying their coordinates.

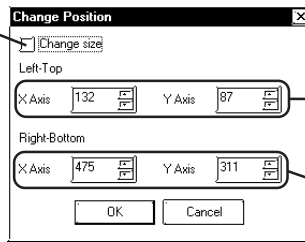

Check this check box to change the size.



Enter the object's left top coordinates.

Enter the object's right bottom coordinates.

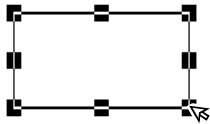
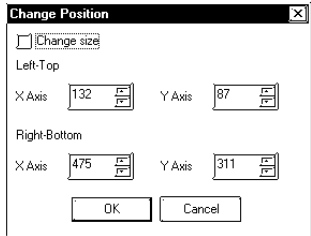
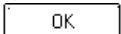
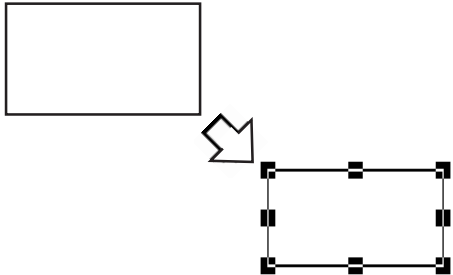
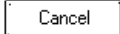
■ Using Coordinates to Change an Object's Position

PROCEDURE	REMARKS
<p>(1) Select a desired object.</p>  <p>(2) Select the [Edit] menu - [Change Coordinates] command.</p> <p>(3) Enter the object's left top and right bottom coordinates.</p>  <p>(4) Click on the  button to execute the command.</p> 	<p>Reference 2.4.1 <i>Selecting Objects</i></p> <p>To change the size, check the Change size check box in step (3).</p> <p>To cancel the coordinates change, click on the  button.</p> <p>To undo the coordinates change, click on the  icon.</p>

2.4.16 Editing the Node of a Multi-segment Line

Creating, Editing, or deleting a node can be performed on a multi-segment line and a filled polygon.

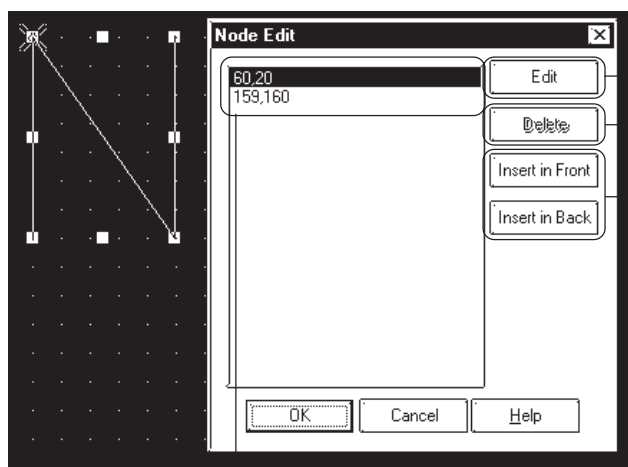

The [Node Edit] dialog displays.
 Deletes the selected peak.
 Adds a node. The added node is the same as the selected node. If the screen capacity is exceeded by the added value, the [Insert in Front] and [Insert in Back] buttons are highlighted and cannot be specified.

If the node edit is selected, the selected point in the displayed dialog is marked with a cross.

■ Editing a Node on a Continuous Line

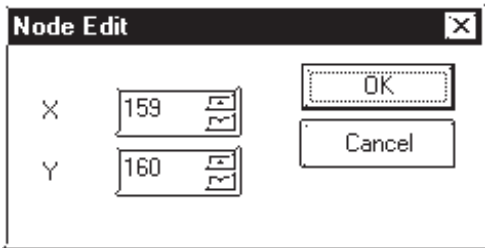
PROCEDURE	REMARKS
<p>(1) Select the desired continuous line.</p> <p>(2) Select [Node Edit(K)] from [Edit(E)].</p> <p>(3) Select the coordinate value that you want to edit.</p> <p>(4) Click on the <input type="button" value="Edit"/> button.</p> <p>(5) Enter the X/Y coordinate values in the coordinate change dialogs.</p>  <p>(6) Click on the <input type="button" value="OK"/> button to run the coordinate change.</p>	<p>Reference 2.4.1 <i>Selecting Objects</i></p> <p>To cancel the coordinate change, Click on the <input type="button" value="Cancel"/> button.</p>

2.4.17 Transferring a Screen to the Clipboard

The current screen is transferred as an image to the clipboard*1. The transferred screen can be utilized by pasting it to other drawing software. The screen types that can be transferred to the clipboard are the Base (B) screen, Mark (M) screen, Trend Graph (T) screen, Keypad (K) and Window (U) screen.

■ Transferring a Screen to the Clipboard

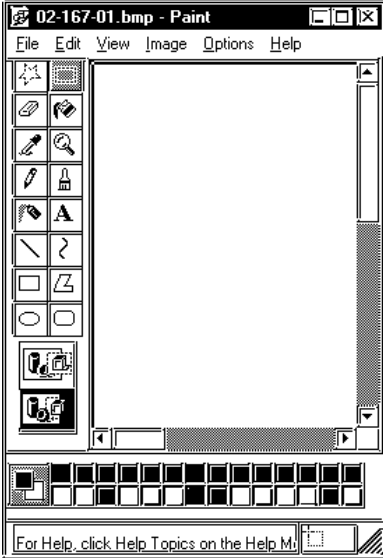
PROCEDURE	REMARKS
<p>(1) Select the [Screen to clipboard] command from the [Edit] menu. The current screen will be transferred to the clipboard.</p> <p>(2) Paste the screen to other drawing software.</p> 	

*1 The clipboard is a storage location where copied or cut data is temporarily stored. The data stored on the clipboard can be copied or moved by pasting it.

2.4.18 Converting a Screen to a Bitmap File

The current screen is converted into a bitmap file, and then saved. The screen types that can be converted are the Base (B) screen, Mark (M) screen, Trend Graph (T) screen, Keyboard (K) and Window (U) screen.

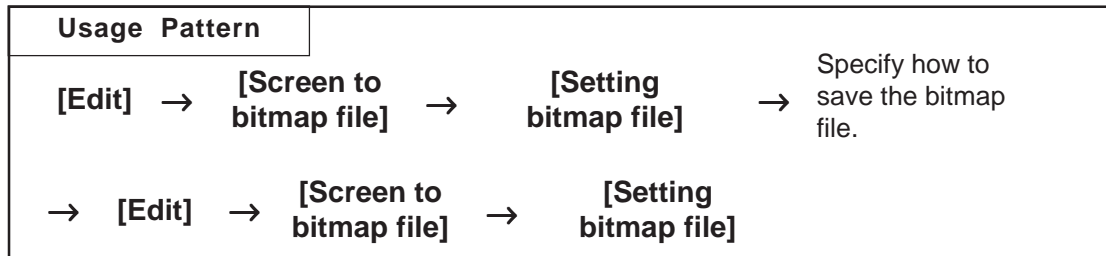

■ Designating a Bitmap's File Name

Before converting the screen to a bitmap file, specify how to save the bitmap file.

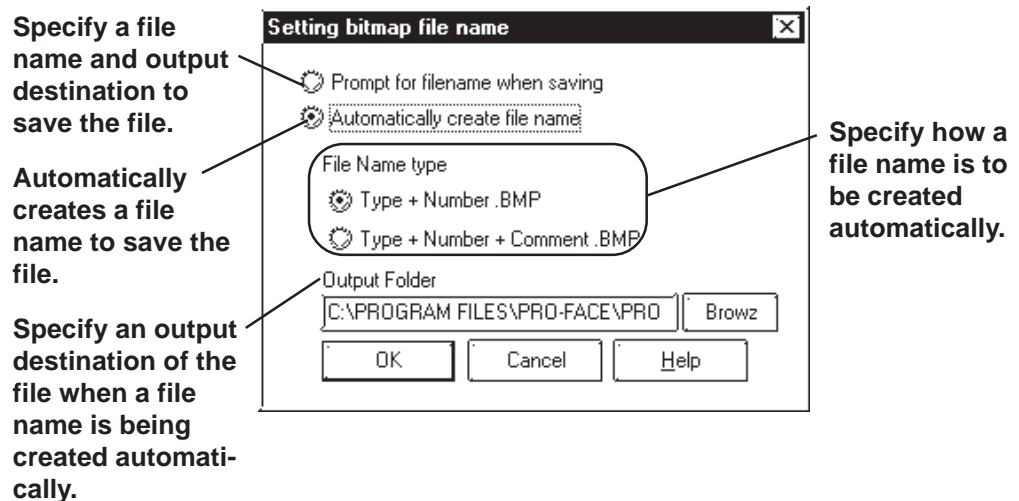

◆ Prompt for filename when saving

When the [Screen to bitmap file] command is executed, the Save As dialog box will appear, where you can specify the location and name of the file to be saved.

◆ Automatically create file name

When the [Screen to bitmap file] command is executed, a file name will be created automatically, and the file saved in a previously specified location.

Example: If the No. 1 screen of the Base (B) screen named "Menu" is converted into a bitmap file:

Screen type + number.BMP → B1.BMP

Screen type + number + screen title.BMP → B1 Menu.BMP

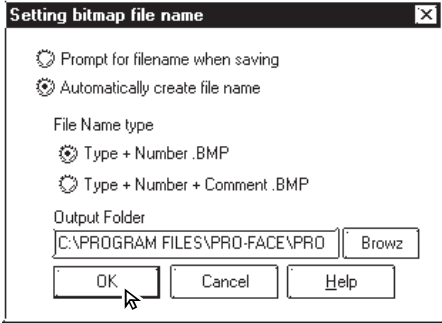
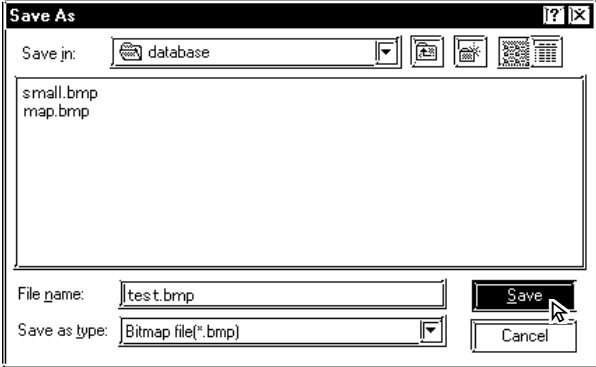

■ Converting a Screen into a Bitmap File

PROCEDURE	REMARKS
<p>(1) Select the [Setting bitmap file] option for the [Screen to bitmap file] command from the [Edit] menu.</p> <p>(2) Select a method for saving the bitmap file, and establish it by clicking on the <input type="button" value="OK"/> button.</p>  <p>(3) Select the [Screen to bitmap file] option for the [Screen to bitmap file] command from the [Edit] menu. When a file name is created automatically, the bitmap file is saved now.</p> <p>(4) If [Prompt for filename when saving] was selected in step (2), specify a file name and output destination, and then click on the <input type="button" value="Save"/> button.</p> 	<p>Save the source screen before performing the conversion. If the source image has not been saved, the bitmap file cannot be created automatically.</p>

2.4.19 Redraw Screen

This command updates the current drawing area display to reflect the latest drawing data. When the Auto Redraw feature is not used, filling and editing objects can cause after-images to remain on the screen. Use this function to remove these images and show the screen as it will appear on the actual GP display.

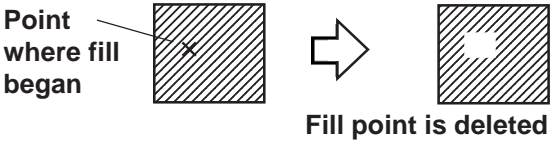
■ Redrawing a Screen

PROCEDURE	REMARKS
<p>Sometimes, when removing an object's filled color, only the fill point area's color will be removed, resulting in a small, non-colored square.</p>  <p>(1) Select the [Edit] menu - [Redraw] command, or click on the  icon.</p> <p>The screen will automatically be refreshed and all the fill color will be removed.</p> 	



2.4.20 Undo

With this function, an operation can be “undone” and the screen display returned to the previous condition. Every time the  icon is clicked on, depending on memory, previous operations will be undone, in succession.



The Redraw Screen function cannot be undone.

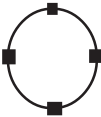

■ Canceling an Action

PROCEDURE	REMARKS
<p>In this example, a circle has been accidentally deleted.</p> <p>(1)Select the [Edit] menu - [Undo] command, or click on the  icon.</p> <p>The circle will reappear and the screen is displayed as it was prior to the deletion.</p> 	<p>To cancel the Undo operation, click on the  icon.</p> <p>Reference 2.4.21 Redo</p>

2.4.21 Redo

With this function, an operation previously undone with the Undo command can be “redone”, if performed immediately after the Undo command is used.

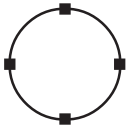
■ Redoing the Previous Undo Command

PROCEDURE	REMARKS
<p>In this example, the undone circle deletion will be redone (i.e. deleted again).</p> <p>(1)Select the [Edit] menu - [Undo] command, or click on the  icon.</p> <p>The circle will reappear.</p>  <p>(2)Select the [Edit] menu - [Redo] command, or click on the  icon.</p> <p>The circle will disappear.</p>	<p>To cancel the Redo operation, click on the  icon.</p> <p>Reference 2.4.20 Undo</p>

2.5 Libraries

The objects you created can be registered. These registered objects are called “Libraries”. You can call up and use the registered Libraries, whenever necessary. Like a pre-made Part Shape, the objects registered in these libraries can be viewed and selected using the Browser function. Multiple objects can be combined and registered, and Marks created on Mark screens can also be registered.

▼ Reference ▲ 3.1 Creating a Mark: the Mark Screen

These items are stored in a Library file (CPW file), separate from Project (PRW) files. When library data is a Mark, it will be saved in a Mark Library (MRK) file. Moving from one Library file to the other allows objects to be called up that were previously used in a variety of screens and Project files.

To call up an item from a Library, or save an item to a Library, either select one of the tool bar’s icons  or use the pull down menu’s [Library] commands.



Note: With both Base and Mark screens open, when the Base screen where the Library Browser is remained open is changed to the Mark screen, the Mark Library Browser cannot be open on the Mark screen. When changing the screen, first close the Library Browser and change the screen, and then open the Library Browser on the newly opened screen.

Objects called up via the [Load Screen], [Load Mark] or [Window Parts (W)] command, as well as D-script cannot be registered.

■ Library Browser

When either  or  icon is clicked on, the Library Browser will appear.

Displays the currently selected item’s registration number and title; clicking on the triangle brings up a list of the items in the current library

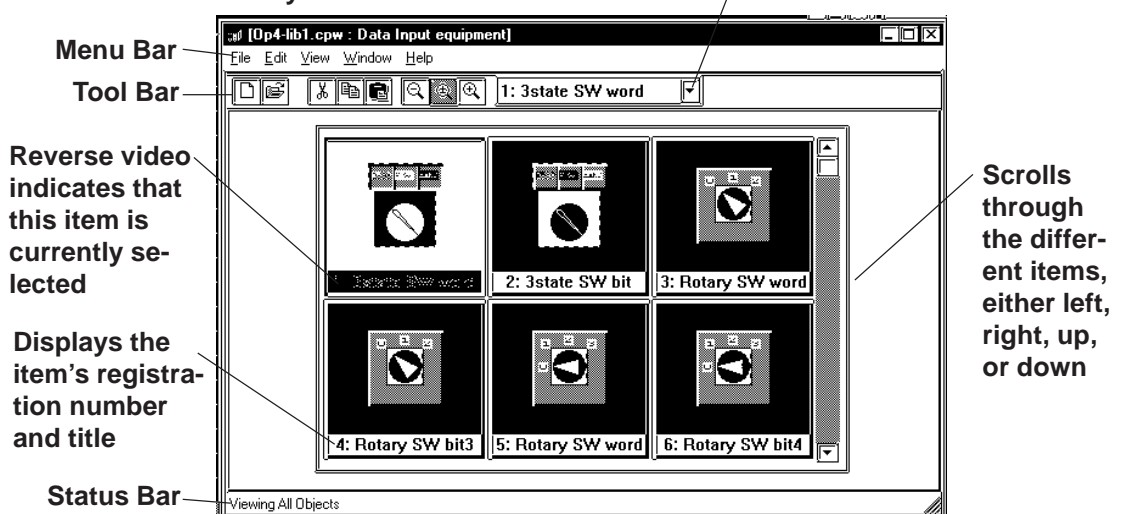

■ Editing Library Items

Three Library Item editing functions are available.



Cuts a Library item (which is then moved to the Clipboard); the Library item can then be moved to another screen using the [Paste] function.



Copies the selected Library item to the Clipboard.



Pastes the Library item Cut or Copied, and temporarily stored in the Clipboard, to another screen. The Library item can also be Pasted to another Library file.



You can remove a Library item using the Delete function. To do so, select the [Delete] command from the Library dialog box's pull down [Edit] menu.

▼ Reference ▲ 2.5.3 Editing Library Items

■ Changing the Library's Display

The Library's image display size and type can be changed. Also, you can change from one Library file to another.

◆ Library Size

When either the , , or  icon is clicked on, or the pull down [View] menu's either [Normal], [Adjust to Fit], or [Full Screen] command is selected, and the Library display size can be changed. When Normal is selected, each Library size will be displayed relatively, allowing you to check the relationship between Libraries for their size. When the Adjust to Fit function is selected, the Library item will be enlarged until it fits inside the Library window's borders. When Full Screen is selected, the Library item will be displayed in its actual (GP) screen size.

◆ Library Type

When the pull down [View] menu's [All Objects], [Part & Tag Objects], or [Graphic Objects] is selected, the Library type(s) shown on the Browser can be selected.

[All Objects]	Displays all the Library items in the selected Library file.
[Part & Tag Objects]	Displays only those items that are either Parts or Tags.
[Graphic Objects]	Displays only those items which are neither Parts nor Tags (i.e. drawn objects).

■ **Switching Library Files**

◆ **Creating a New Library File**

When the  icon is clicked on, or the pull down [File] menu's [New] command is selected, the Dialog box shown below will appear. When a Description is input and the button is clicked on, a new Library file will appear.

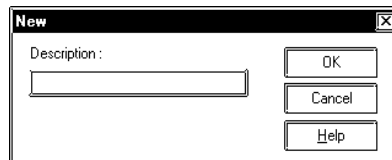

◆ **Selecting (Calling Up) another Library File**

When the  icon is clicked on, or the pull down [File] menu's [Select File] command is selected, the Library file list will appear. By selecting (dragging) the desired Library file from this list, other Library files can be called up.

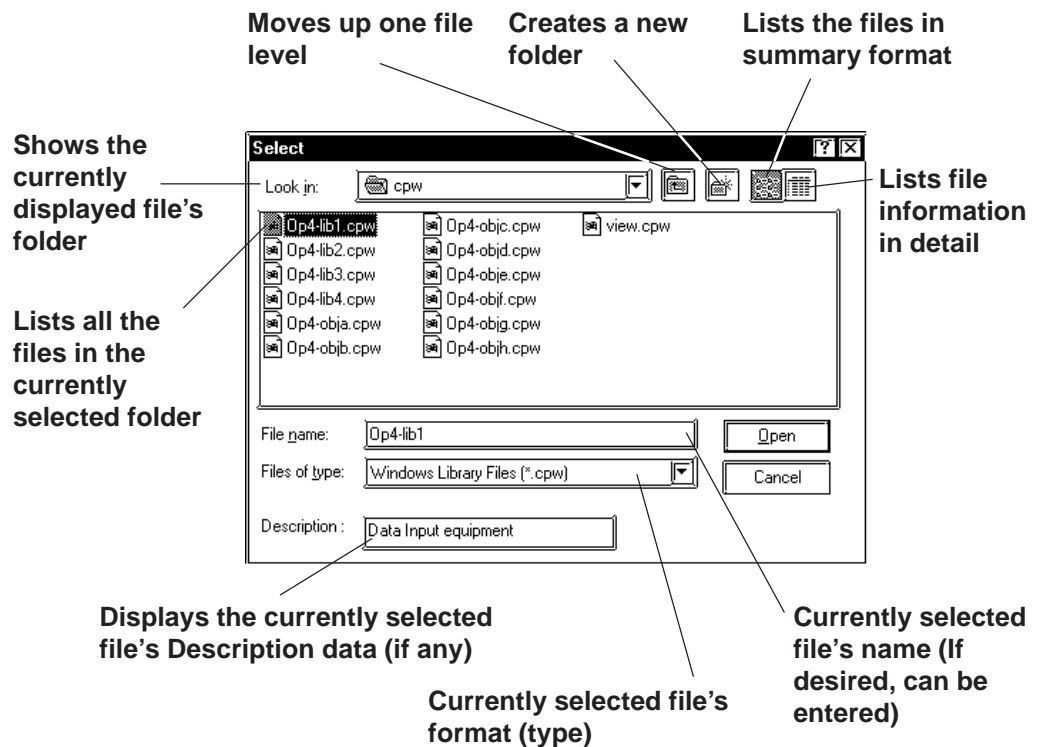

Two types of Library files are available; the Library files created using the GP-PRO/PBIII (DOS Version) (DOS Library file: *. CPL), and the Library files created using GP-PRO/PBIII (Windows® Version) (Windows Library file: *. CPW and *.MRK). Select either one.

Files created using Parts Box (*. CPL) can be converted into GP-PRO/PBIII for Windows format (*. CPW).

▼ **Reference** ▲ *12.1 File Converter*

■ Modifying Library File Names (Titles)

Library filenames can also be changed. Simply select a library from the file list, then select [Property] from the [Edit] menu, and the Property screen will appear. Type in the filename (title) that you wish to use and click on OK.

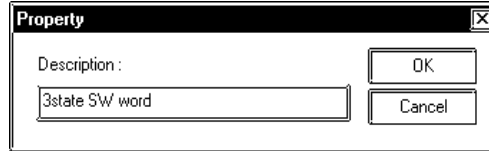









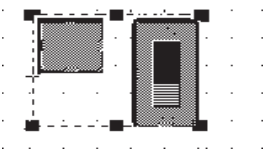

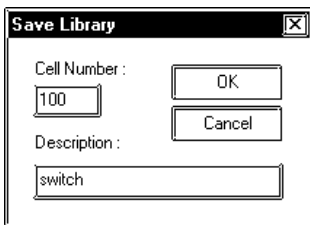
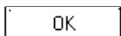
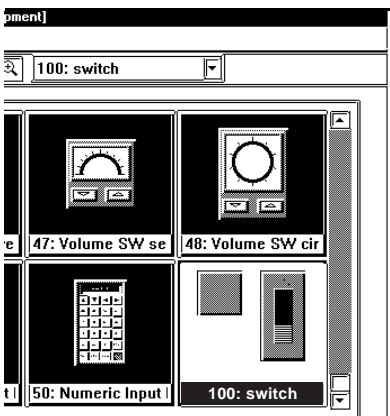
■ Displaying the Browser at the Top of the Normal Screen



If the [Always on Top] option is selected from the [Window] menu, whenever the Library Browser is called up, it will be placed at the top of the current window. If this option is not selected, selecting another screen will place that screen over the Library screen, hiding it from view.

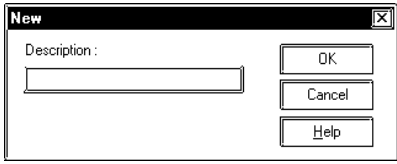
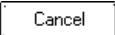
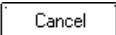
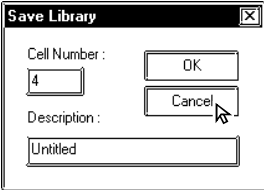

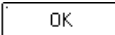
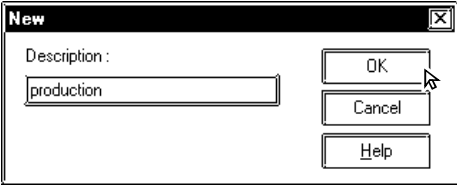
2.5.1 Registering Library Items

Here, the procedure for registering a Library is explained.

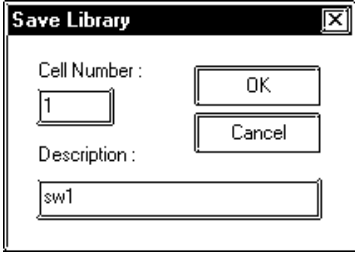
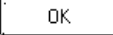
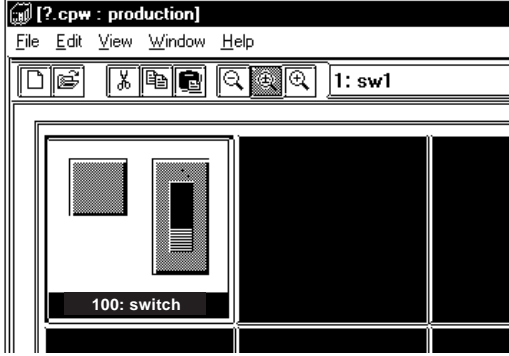
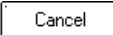
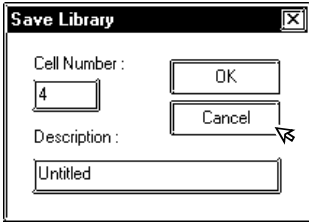
PROCEDURE	REMARKS
<p>(1) Select objects to be registered as Library items.</p>  <p>(2) Select the [Library] menu - [Register Library] command, or click on the  icon.</p> <p><A. When registering a new Library item to the currently open Library file:></p> <p>(3) Enter the Library's registration number and description.</p> <p>In the Cell Number area, the smallest of the currently open Library file's unused numbers will be automatically displayed. To change it, simply enter the desired number.</p>  <p>(4) Click on the  button to register the number.</p> <p>The registered Library will then be displayed in the Browser.</p> 	<p>Reference 2.4.1 <i>Selecting Objects</i></p> <p>D-scripts as well as objects called up via the [Load Screen (O)], [Load Mark (M)] and [Window Parts (W)] commands cannot be registered.</p> <p>If the Library Browser is already showing, click on either  or  icon in the screen editor drawing area, and the  icon in the Library Browser, which will perform the function of step (2).</p> <p>The following procedures will differ depending on the Library file registered.</p> <ul style="list-style-type: none"> • When registering a new Library item to the currently open Library file: • When no Library file is displayed: • When registering a Library item to a new Library file: • When registering a Library item to a Library file other than the currently open one: <p>Up to 200 Library items can be registered in one file.</p>

PROCEDURE	REMARKS
<p><B. When no Library file is displayed:></p> <p>(3) The “New” dialog box will appear.</p>  <p>When registering a Library item to a new Library file. <C. When registering a Library to a new Library file>'s step (5)</p> <p>When registering a Library item to an existing Library file: Click on the  button.</p> <p><D. When registering a Library item to a Library file other than the currently open one>'s step (4)</p> <p><C. When registering a Library item to a new Library file:></p> <p>(3) Click on the  button.</p>  <p>(4) Via the Library Browser, select the [File] menu - [New] command, or click on the  icon.</p> <p>(5) Enter a comment and click on the  button.</p>  <p>(6) Via the Screen Editor, select the [Library] menu - [Register Library] command, or click on the  icon.</p>	<p>Enter the file name when the Library file is saved.</p> <p>▼ Reference ▲ 2.5.4 Saving Libraries and Quitting ■ Saving a Library File Under Another Name</p> <p>A comment of up to 60 characters can be entered.</p> <p>Enter a description up to 60 characters.</p> <p>Enter the file name when the Library file is saved.</p> <p>▼ Reference ▲ 2.5.4 Saving Libraries and Quitting ■ Saving a Library File Under Another Name</p>

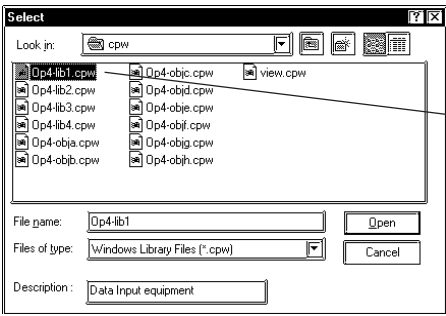
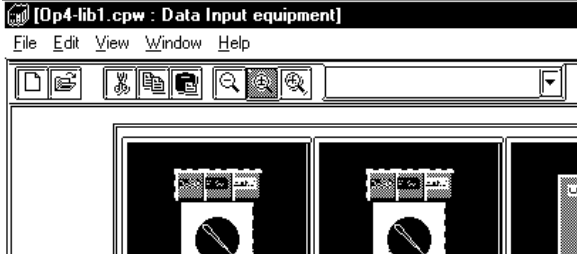
PROCEDURE	REMARKS
<p>(7) Enter a Cell Number and Description.</p>  <p>(8) Click on the  button. The newly registered Library item will appear in the Browser.</p>  <p><D. When registering a Library item to a Library file other than the currently open one.</p> <p>(3) Click on the  button.</p>  <p>(4) Via the Library Browser, select the [File] menu - [Select File] command, or click on the  icon.</p>	<p>A maximum of 200 Library items can be registered in each Library file.</p> <p>After creating a new Library item, if you attempt to create or select another Library file without first saving the item via the [Save As...] function, a prompt will appear, asking whether the newly created Library item should be saved or not.</p> <p>Reference For the procedures for saving a Library item, refer to 2.5.4 Saving Libraries and Quitting ■ Saving a Library File</p>

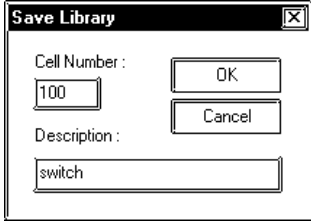
PROCEDURE	REMARKS
<p>(5) Select the desired Library file from the list, or input the Library file name in the file name area.</p>  <p>(6) Click on the <input type="button" value="Open"/> button to display the selected Library file.</p>  <p>(7) Via the Screen Editor, select the [Library] menu - [Register Library] command, or click on the  icon on the Draw Tool Bar.</p> <p>(8) Input a Cell Number and Description. In the Cell Number area, the smallest of the currently open Library file's unused numbers will be automatically displayed. To change it, enter the desired number.</p> 	<p>Reference 2.5 Libraries ■ <i>Switching Library Files</i></p> <p>When selecting a Library file in another directory, use the [Look in:] window.</p> <p>In step (5), simply move the cursor to the desired Library file name and double-click on it to open it. By doing so, the <input type="button" value="Open"/> (Step 6) button does not need to be used.</p>

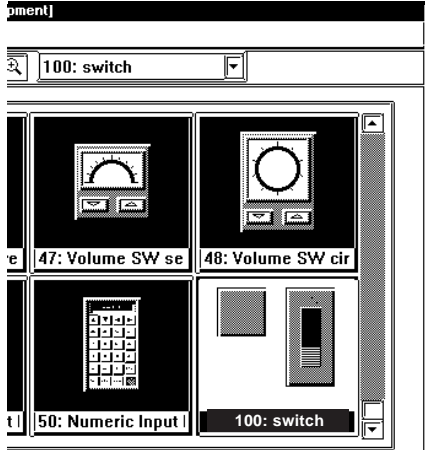



PROCEDURE	REMARKS
<p>(9) Click on the <input type="button" value="OK"/> button to register the item. The registered Library item will appear in the Browser.</p> 	<p>Up to 200 libraries can be registered in one file.</p>

■ Using the Cut, Copy, and Paste Functions

Library items can be Cut, Copied and Pasted from the screen drawing area to Browser. First, select the desired Library item in the drawing area, and then either Cut or Copy it; then, Paste it to the current Library Browser.

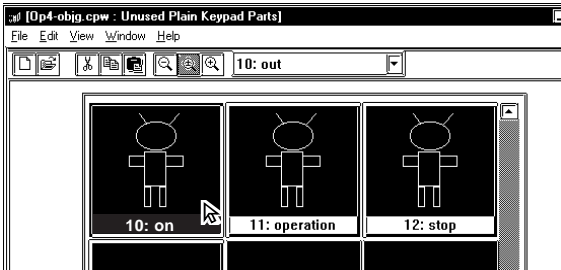
2.5.2 Placing Library Items

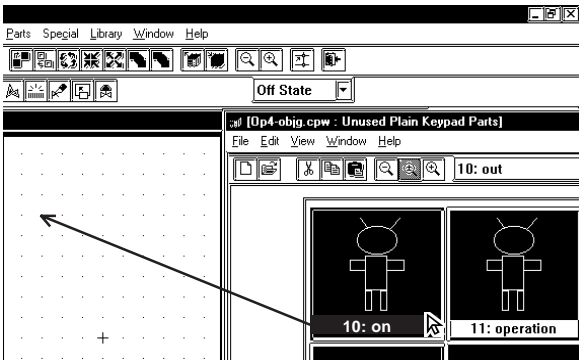
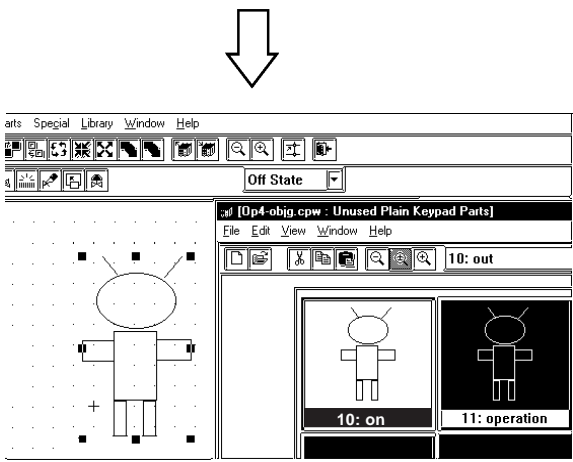
Here, items registered in a Library file are placed on a drawing area.

PROCEDURE	REMARKS
<p>(1) Via the Screen Editor, select the [Library] menu - [Call Up Library] command, or click on the  icon on the Draw Tool Bar.</p>	
<p>(2) Select a Library Item to be read out from the Browser.</p> 	<p>Library items Cut, Copied, or Pasted between the screen and the Browser. Simply select the desired Library item and perform the command.</p> <p>When calling up an item from a file different than the currently displayed file, click on the  icon to bring up a file list.</p>
<p>(3) Drag the Library item to the desired position in the drawing area.</p> <p>The Library item can be placed on any open screens, and will be displayed in the drawing area. If desired use the sizing handles to alter the item's size.</p>	<p>Reference 2.5 Libraries Switching Library Files</p>
	<p>The Library item's top left corner is the placement point.</p>
	<p>To cancel the placement, click on the screen editor's  icon.</p> <p>Reference To change a Library item's size, refer to 2.4.3 Scaling Up/Down</p> <p>Items called up are automatically grouped. They can be freely edited after ungrouping them by clicking on the  icon.</p> <p>Reference 2.4.12 Group/Ungroup</p> <p>Grouped library items containing Parts cannot be scaled up or down.</p>

When a Library that contains Parts is called up, the Confirm Device Address screen will appear. After entering each Part's address, click on the button. To cancel these settings, click on the button.

▼ Reference ▲ 2.4.14 Changing Attributes, ■ Confirming Addresses

When the Library placed on the screen is double-clicked on, the Confirm Device Address dialog box shown below will appear, allowing you to change the Part's previously entered addresses.

Address	Function	Parts Name	Part ID	Description
X00010	Bit Set (C)	Bit Switch	BS_012	
X00042	Bit Set (C)	Bit Switch	BS_013	



After a Tag is registered in a Library, if multiple identical libraries are then placed on the screen, their Tag names will be duplicated. After placing them, be sure to change their Tag names via either their attribute dialog boxes, or the Tag List; especially if a common start up bit has been created for a K-tag.

▼ Reference ▲ For Changing Attributes, refer to 2.4.14 Changing Attributes
 For Tag List, refer to 2.8.6 Tag List
 For K-tags, refer to *Tag Reference Manual, 2. 11 K-Tag (Keypad Input)*

■ Using the Cut, Copy, and Paste Functions







Library items can be Cut, Copied, and Pasted from the screen drawing area to the Browser. First, select the desired Library item in the drawing area and Cut or Copy it; then, Paste it to the Library Browser.

2.5.3 Editing Library Items

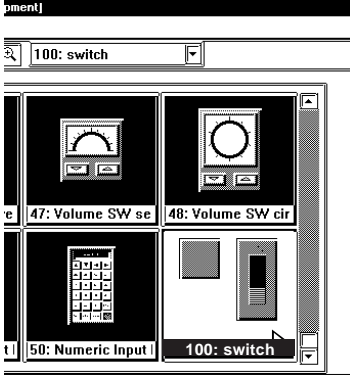
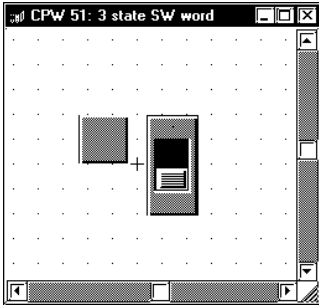
Library Items can be edited, Deleted, Copied, Cut, or Pasted.

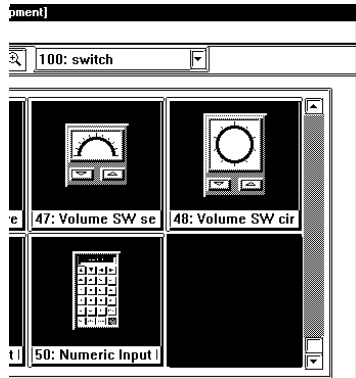

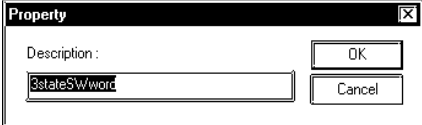
■ Editing a Library Item

Here, a registered Library item is edited.

PROCEDURE	REMARKS
<p>(1) Select and double-click the Library item to be edited from the Browser.</p>  <p>(2) Edit that Library item.</p>  <p>(3) Via the Screen Editor, select the [Screen] menu - [Save] command, or click on the  icon on the Main Tool Bar.</p> 	<p>In order to call up a Library item from a Library file which is different from the currently displayed file, click on the  icon.</p> <p>▼ Reference 2.5 Libraries ■ Switching Library Files</p> <p>When double-clicking on a Library item's title, the title editing screen will appear. (Title Change Screen)</p>  <p> Important Once an item is edited, it cannot be Undone.</p>



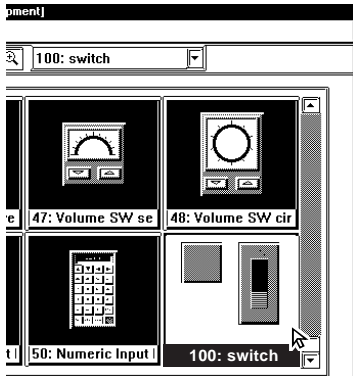
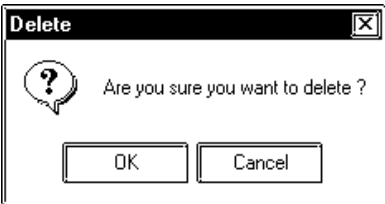
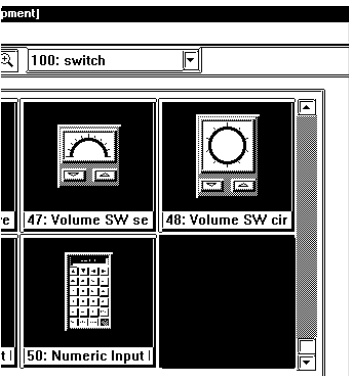



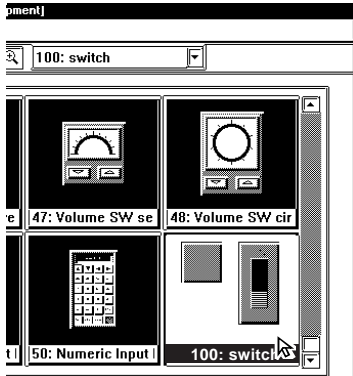

■ **Deleting a Library Item**

Here, a registered Library item is deleted.

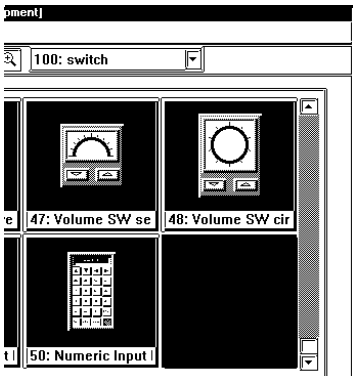
PROCEDURE	REMARKS
<p>(1) Select the Library item to be deleted from the Browser.</p>  <p>(2) Select the [Delete] command from the Library Browser's [Edit] menu. A dialog box appears to confirm your command.</p>  <p>(3) Click on the <input type="button" value="OK"/> button, and the Library item will be deleted.</p> 	<p>In order to call up a Library item from a Library file which is different from the currently displayed file, click on the  icon.</p> <p>▼ Reference ▲ 2.5 Libraries ■ Switching Library Files</p> <p> Important <i>Once an item is deleted, it cannot be Undone.</i></p>

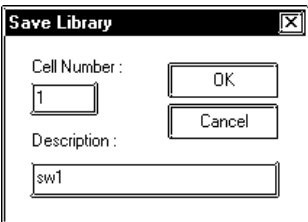
■ Cutting a Library Item (from a Library File) and Pasting





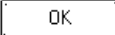
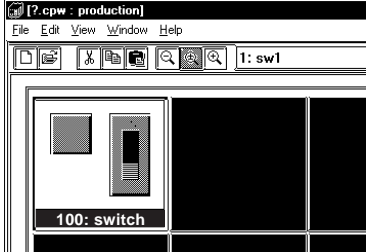

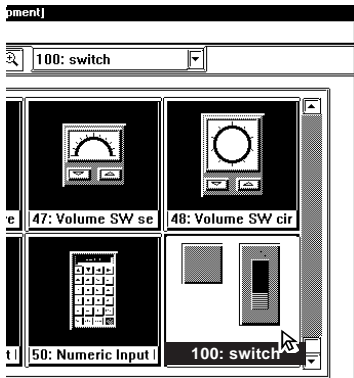

Here, a registered Library item is Cut and Pasted.

PROCEDURE	REMARKS
<p>(1) Select a Library item to be cut (out) from the Browser.</p>  <p>(2) Via the Library Browser, select the [Edit] menu - [Cut] command, or click on the  icon. The selected Library will be cut.</p>  <p>(3) Open a desired Library file and, via the Library Browser, select the [Edit] menu - [Paste] command, or click on the  icon.</p> <p>The following steps are the same as those used for a Library Item registration.</p> <p>(4) Input the Item's Cell Number and Description.</p> <p>In the Register Number area, the smallest number in the currently open Library file's empty numbers will be automatically displayed. To change it, input the desired number.</p> 	<p>In order to call up a Library item from a Library file different than the currently displayed Library file, click on the  icon.</p> <p>Reference 2.5 Libraries ■ Switching Library Files</p> <p>To register the Library item to a new Library file, click on the  icon.</p> <p>To register the Library item to a Library file different from the currently displayed one, click on the  icon.</p> <p>Reference 2.5 Libraries ■ Switching Library Files</p>

PROCEDURE	REMARKS
<p>(5) Click on the  button to register the Library Item.</p> <p>The registered Library will be displayed on the Browser.</p> 	

■ Copying a Library Item

Here, a previously registered Library item will be copied.

PROCEDURE	REMARKS
<p>(1) Open the desired Library Item's Library file and select the Library item from the Browser.</p>  <p>(2) Via the Library Browser, select the [Edit] menu - [Copy] command, or click on the  icon.</p> <p>The Library item will be copied to the Clipboard.</p> <p>(3) Open the destination Library file and select the [Edit] menu - [Paste] command, or click on the Library Browser's  icon.</p>	<p>In order to call up a Library item from a Library file different than the currently displayed Library file, click on the  icon.</p> <p>Reference  <i>2.5 Libraries</i> ■ Switching Library Files</p> <p>To register the Library item to a new Library file, click on the  icon.</p> <p>To register the Library item to a Library file different than the current one, click on the  icon to call up a list of Library files.</p> <p>Reference  <i>2.5 Libraries</i> ■ Switching Library Files</p>

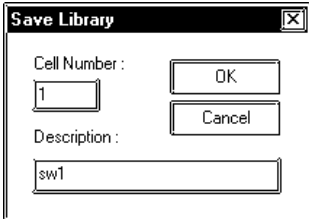
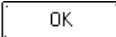
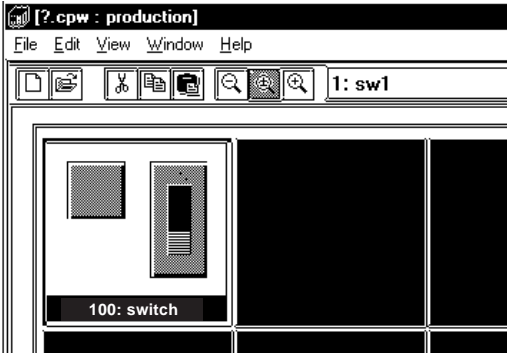
PROCEDURE	REMARKS
<p>Hereafter, steps are the same as Library Item Registration.</p> <p>(4) Input the Item's Cell Number and Description. In the Register Number area, the smallest of the currently open Library file's unused numbers will be automatically displayed. To change it, enter the desired number.</p>  <p>(5) Click on the  button to register the Item. The registered Item will appear in the Browser.</p> 	

2.5.4 Saving Libraries and Quitting

■ Saving a Library File

When a Library file’s contents are changed, the changed data will automatically overwrite the old data and be saved. However, if the Library file has been newly created, when you attempt to create or select another Library file, a prompt will appear asking if whether the new file is to be saved or not. When Yes is clicked on, the [Save As...] Dialog box will appear.

▼ Reference ▲ 2.5.4 ■ Saving a Library File Under Another Name

■ Saving a Library File Under Another Name

Here, the Library File will be saved under a different name.

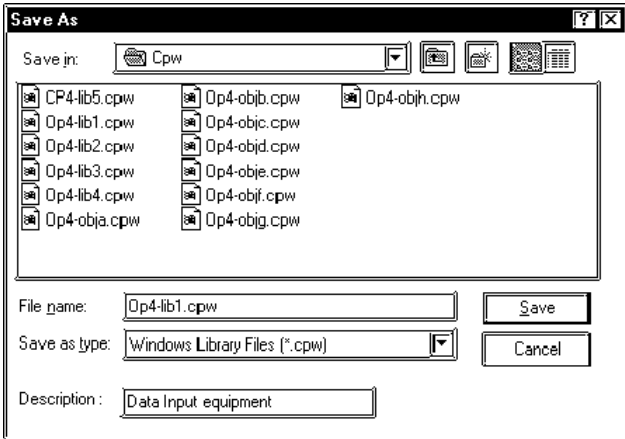
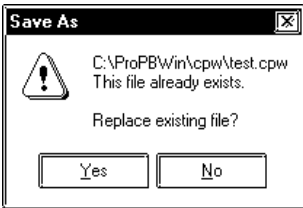
PROCEDURE	REMARKS
<p>(1) Select the [Save As...] command from the Library Browser’s [File] menu.</p> <p>(2) The currently selected Library file name and its comment data, if any, will appear. Input a new file name and change the desired settings.</p>  <p>(3) Click on the <input type="button" value="Save"/> button to save the Library.</p> <p>When a project with the same name already exists, a prompt asking whether the new name should overwrite the old name will appear; to do so, click on the <input type="button" value="Yes"/> button. When you do not want to overwrite, click on the <input type="button" value="No"/> button.</p> 	<p>The file name can be input within 255 characters, including a path and extension.</p>

■ Quitting the Library Browser

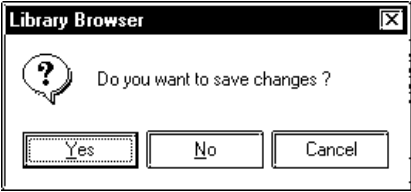
PROCEDURE	REMARKS
<p>(1) Select the pull down menu [File]’s [Exit] command. If a newly created Library file has not been saved yet, a prompt asking whether the new Library file should be saved, will appear. When the <input type="button" value="Yes"/> button is clicked, the “Save As..” dialog box will appear, and when the <input type="button" value="No"/> button is clicked, the Library file will not be saved and the Library Browser will quit. Then, a Library file creation or selection screen will appear.</p> 	<p>Clicking on the Library Browser’s top right mark <input type="button" value="X"/> can also be used to quit.</p> <p>Reference ■ <i>Saving a Library File Under Another Name</i></p>

2.6 D-Script/Global D-Script

The GP-PRO/PB III provides a special feature that enables you to create a program to execute functions, in addition to tags. This feature is given by D-Scripts/Global D-Scripts. The display load on the PLC can be reduced significantly by creating and registering a program with D-Scripts/Global D-Scripts. D-Scripts are used on each screen and serve as programs that are only effective on that screen. Global D-Scripts serve as programs that are effective on all the screens.

Using D-Script, you can program separately the trigger used and the action it performs. Then, when the trigger conditions are satisfied, the script is performed. The procedures for writing a program with Global D-Scripts are the same as those for writing a program with D-Scripts.

For more detailed information about D-script and Global D-script, refer to the Tag Reference Manual.

Reference *Tag Reference Manual, 3.1 D-Script/Global D-Script*

D-Scripts and Global D-Scripts cannot be registered as Library items.



- **D-script and Global D-script cannot be registered as Libraries.**
- **To select [Global D-Script], open any Base screen in advance.**

Usage Pattern
<p>[Special] → [D-Script] or [Global D-Script] → Add, Modify, or Delete → Close or the Esc key</p>

An example of the D-Script dialog box (the initial screen) is shown below.

Adds a D-Script

Deletes a registered D-Script

Allows you to edit the contents of a D-Script

Copies the contents of a D-Script

Pastes the copied contents of a D-Script

Lists the D-Script ID numbers and descriptions

■ Registering D-Script Settings

Here, additional D-Scripts can be registered. When the button is clicked on, the D-Script Editor will appear.

Enter the D-Script's ID No. (from 00000 to 99999)

Annotations for the D-Script Editor window:

- Enter a description here
- Displays the D-Script's command tool box
- The programmed "actions" of the D-Script
- Message area (window)
- Enter the D-Script's ID No. (from 00000 to 99999)
- Trigger area
- Displays defined function names

■ D-Script Tool Box

The D-Script tool box contains icons for D-Script commands and Statements and constant input icons.

Reference *Tag Reference Manual, 3.1 D-Script/Global D-Script*

When the tool box check box is checked, the following tool box will appear.

■ **Definition of Functions**

Programs to be used for D-Script are defined as functions. The defined functions can be called up to the activated program and used. Also these functions can be nested up to 10 layers. When the  icon is clicked on in the D-Script Editor, the D-Script function setting screen will appear.

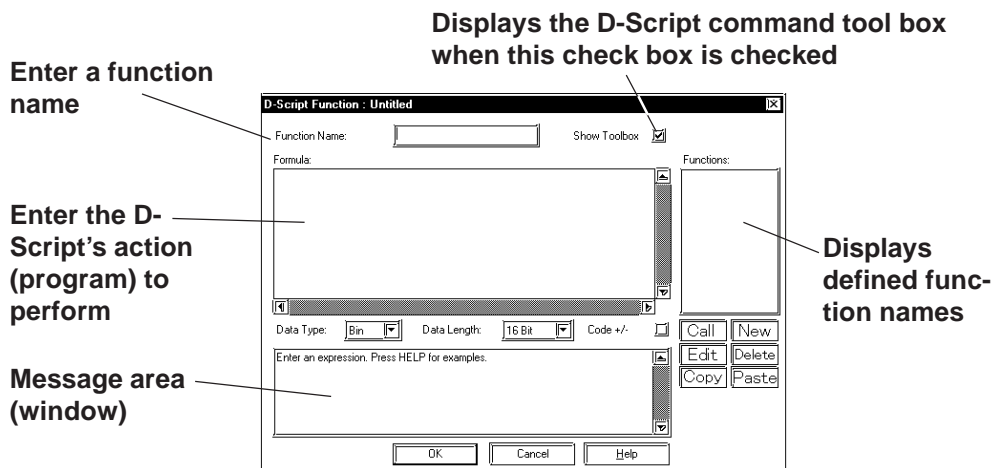

Note: Only alphanumeric and the “_ (under bar)” can be used for function names; up to 20 characters can be entered.

■ **Deleting D-Script Settings**

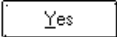
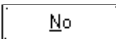
Here, existing D-Script settings can be deleted. After selecting the D-Script settings to be deleted from the listing, and clicking on the  button, the Confirm Script Delete dialog box will appear. When the  button is clicked on, the D-Script settings will be deleted. When the  button is clicked on, the deletion command will be canceled.

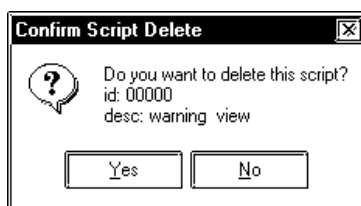

■ Editing D-Script Settings

Here, registered D-Script settings are changed. After selecting the D-Script settings to be changed from the D-Script list and clicking on the button, an additional registration screen will appear. Click on the button to change the D-Script settings. To cancel the Change command, click on the button.



- ***It is not possible to use the Project Manager [Utility]'s [Convert Address] area to modify addresses used in a D-Script. Any D-Script program that requires address conversion will need to be edited manually.***
- ***If the [Save As..] function has been used to change a project file's Device/PLC Type, the D-Script program will not be able to automatically change those addresses.***
- ***Be sure to not use D-Script to perform any life-threatening, or possibly damaging actions!***

■ D-Script Settings: Copy and Paste

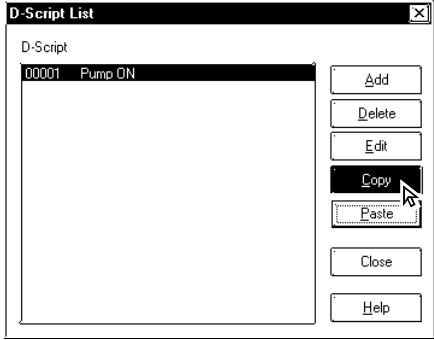
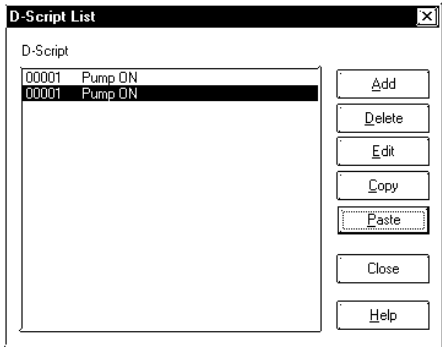
PROCEDURE	REMARKS
<p>(1) Select the pull down [Special] menu's [D-Script] command.</p> <p>(2) Click on the <input type="button" value="Copy"/> button.</p>  <p>(3) When the <input type="button" value="Paste"/> button is clicked on, the D-Script copied in step (2) will be added. The D-Script's ID number will automatically be assigned to the smallest number currently available.</p> 	<p>This D-Script can also be copied to another screen.</p>

■ Registering D-Script settings

The method for registering D-Script settings is shown below.

For a temperature controller, D-Script detects the PLC’s error bit and displays alarm messages when the temperature rises to 70 °C or above, or has fallen lower than 30°C. Also, the number of the errors detected are counted.

When error bit M0001 turns ON...

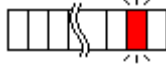

If the temperature has risen to higher than 70°C, screen B100 is displayed.

ALARM
Over 70 deg. !!

If the temperature has fallen to lower than 30°C, screen B101 is displayed.

ALARM
Under 30 deg. !!

Also, the number of occurrences is counted.

Above 70

Below 30

- Temperature data is stored in D200.
- When the temperature is 70 °C or more, the number of Alarms is stored in LS300.
- When the temperature is 30 °C or less, the number of Alarms is stored in LS301.
- The alarm display screen number is stored in LS302.

To display the above mentioned alarm messages, L and N-tags are used as follows:

- (1) Create the alarm message screens, B100 and B101.
- (2) Set up an L Tag to display the Alarm message screen. (Direct designation, word address: LS302)
- (3) Set up an N-tag to display the number of the errors counted when the temperature rises to 70 °C or more. (Word address: LS300)
- (4) Set up an N-tag to display the number of the errors counted when the temperature falls to 30 °C or less. (Word address: LS301)

▼ **Reference** ◀ For details concerning each Tag, refer to the *Tag Reference Manual, 1.3 Tag List.*

PROCEDURE	REMARKS
<p>(1) Select the pull down [Special] menu’s [D-Script] command.</p> <p>(2) Click on the <input type="button" value="Add..."/> button.</p>	<p>The number of D-script registrations will be limited depending on each GP memory capacity.</p> <p>▼ Reference ◀ <i>Tag Reference Manual 3.1.4 D-Script/Global D-Script Limitations</i></p>

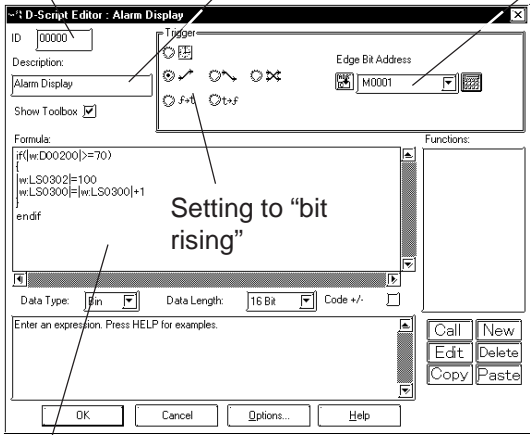
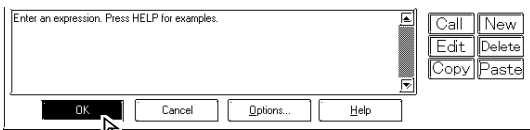
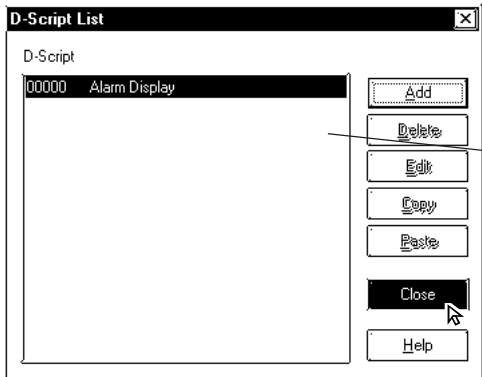
PROCEDURE	REMARKS
<p>(3) Perform settings for each item such as ID, Trigger, Formula, etc.</p> <p>Enter 00000 Enter Alarm Display Enter M0001</p>  <p>Program</p> <pre> if ([W:D00200] >=70) { //When the temperature is 70°C or higher: [W:LS0302] =100 //Assign screen No. 100 for the "Over 70°C" alarm message. [W:LS0300] =[W:LS0300] +1 //The number of errors counted increases. } endif if ([W:D00200] <=30) { //When the temperature is 30°C or lower: [W:LS0302] =101 //Assign screen No. 101 for the "Under 30°C" Alarm message. [W:LS0301] =[W:LS0301] +1 //The number of errors counted increases. } endif </pre> <p>(4) Click on the <input type="button" value="OK"/> button.</p>  <p>(5) Click on the <input type="button" value="Close"/> button to quit registration.</p>  <p>The current registration information is shown here.</p>	<p>A description can be entered of up to 20 characters.</p> <p>Reference <i>Tag Reference Manual, 3.1 D-Script/Global D-Script</i></p>

2.7 Data Sampling

Address data designated in the PLC is sampled and stored (backed up) in the GP unit. When using this function for a graph (Tag or Part)'s channel, Trend graph data can also be stored (backed up).

Up to 20 sets of Data Sampling can be entered, including the number of channels; the setting attributes can also be confirmed in the Tag List (Data Sampling).

For more detailed information about data sampling, refer to the Tag Reference Manual.

Reference *Tag Reference Manual, 3.2 Data Sampling Settings*



An example of the Data Sampling Setting dialog box is shown below.

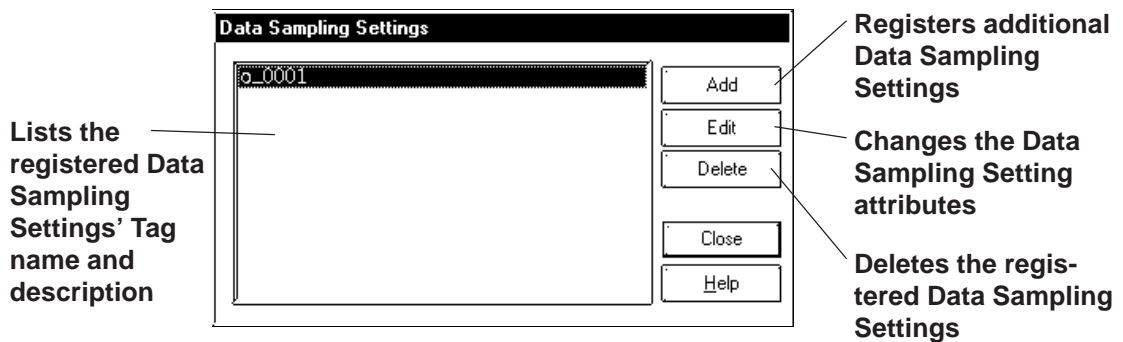

■ Registering Data Sampling Settings

Additional Data Sampling Settings are registered.

When the button is clicked on, the Data Sampling Setting screen will appear. For each item's setting, refer to Tag Reference Manual.

▼ **Reference** ▲ *Tag Reference Manual, 3.2 Data Sampling Settings*

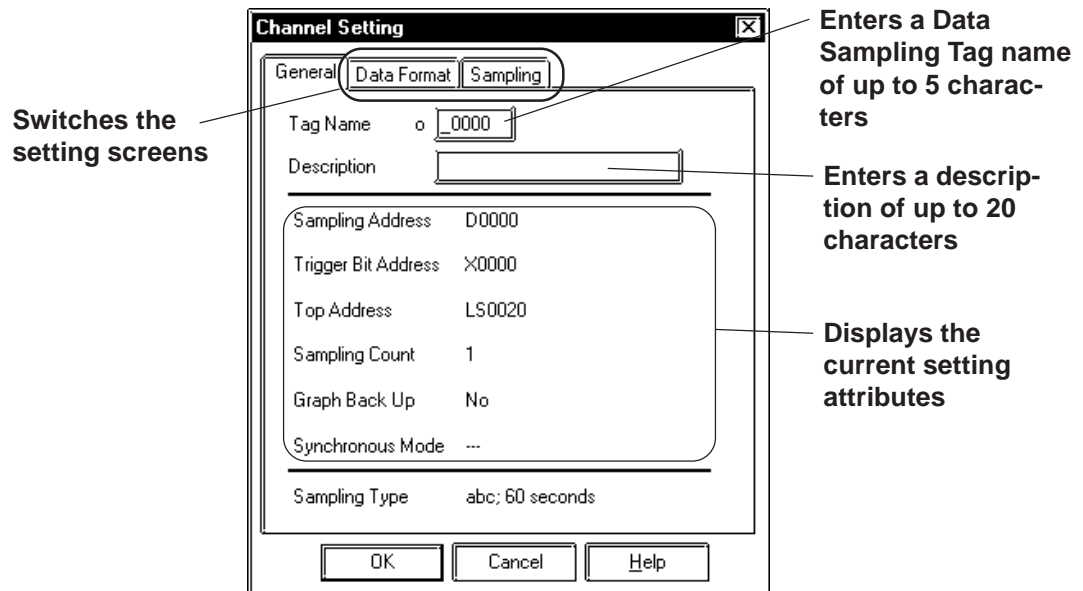

■ Deleting Data Sampling Settings

Here, the registered Data Sampling Settings can be deleted. Select a Data Sampling to be deleted from the list. When the button is clicked on, a dialog box will appear to confirm your command. If you click on the

button, the Data Sampling will be deleted; if you click on the button, the deletion will be canceled.

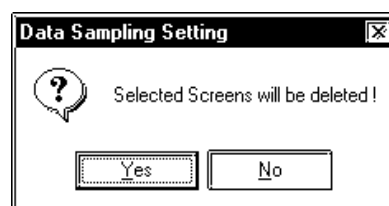

■ Editing Data Sampling Settings

Here, the registered Data Sampling Setting attributes can be changed. Select a Data Sampling to be changed from the list. When the button is clicked on, the Add (registration) dialog box will appear. If you click on the

button, the D-Script setting attributes will be changed, and if you click on the button, editing will be canceled.

■ **Setting Up Data Sampling**

The Data Sampling setting method is shown below.

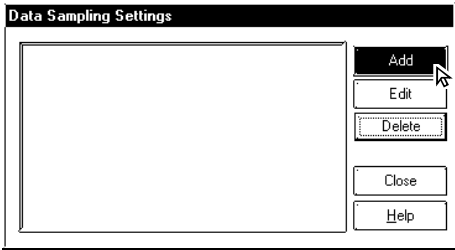
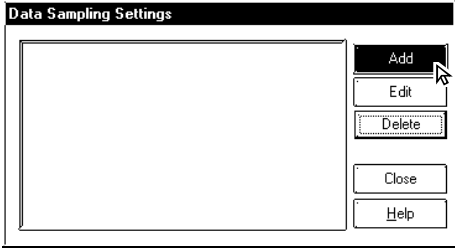
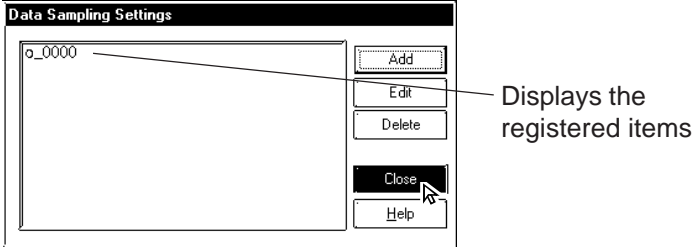
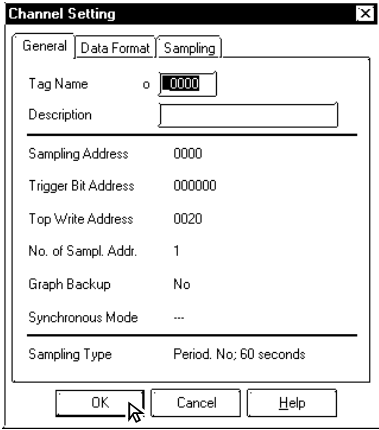
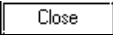
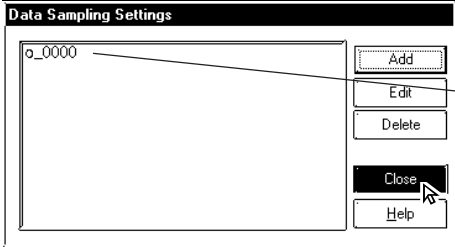
PROCEDURE	REMARKS
<p>(1) Select [Data Sampling] from the [Special] pull down menu.</p> <p>(2) Click on the  button.</p>  <p>(3) Perform the data sampling settings. After the settings are all completed, click on the  button.</p>  <p>(4) Click on the  button to quit the registration.</p>  <p style="margin-left: 400px;">Displays the registered items</p>	<p>Up to 20 Data Sampling sets, including Trend graph channels, can be entered.</p> <p>Enter a Tag name of up to 5 characters.</p> <p>Reference <i>Tag Reference Manual, 3.2 Data Sampling Settings</i></p>

2.8 Efficient Drawing Techniques

This section explains how the use of grids, changing display states, and the help function can all help to increase your drawing efficiency.

2.8.1 Grid/Snap

Grid Points are placed at regular intervals on your screen and divide the drawing area into a coordinate “grid” pattern; when the Snap to Grid function is enabled, objects that are drawn will automatically “snap” (be aligned) on this “grid” pattern. Use the Grid Point Spacing command to adjust the density of the Grid points, and to display the grid or not. Also, grid points can be displayed as grid lines, not as dots. Grid Points are not shown on the GP unit’s display.

Select the pull down menu [Option]’s [Grid/Snap] command.

■ Grid/Snap Settings dialog box

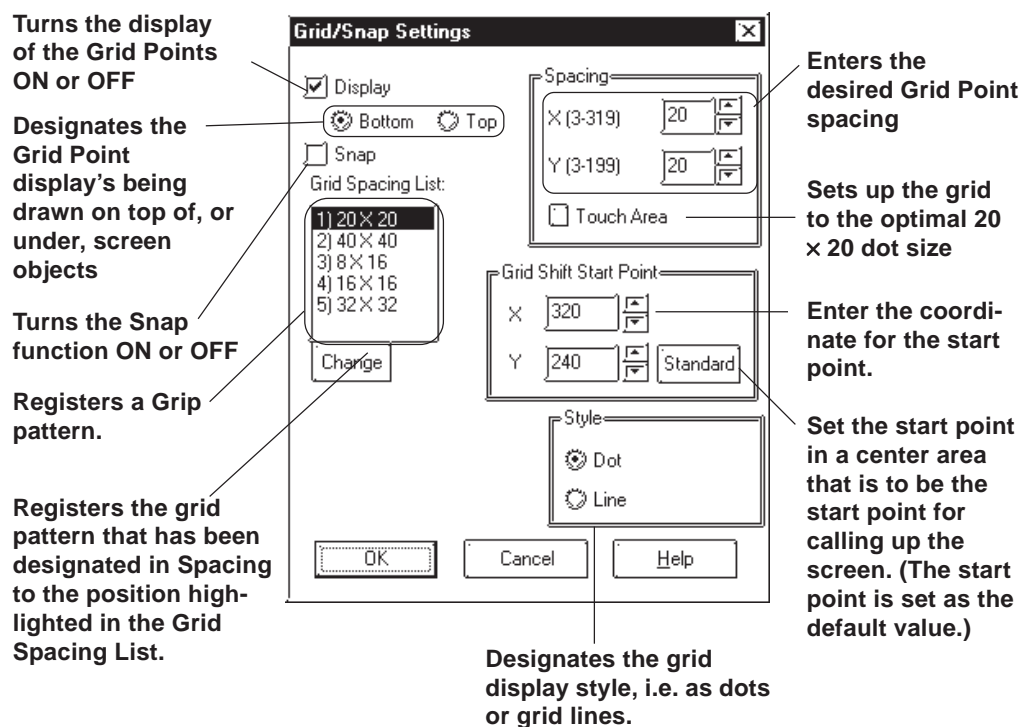

◆ Display

Sets the Grid Point display state (displayed or not displayed).

Grid pattern display can also be changed in the Grid Tool Bar’s grid pattern selection list box.

◆ Snap

When the Snap check box is checked, the cursor will “snap” to the grid; objects can only be drawn on points (start & end) along the grid.



Turning the Snap function ON or OFF can also be performed via the Grid/Snap Tool Bar's icons  and .

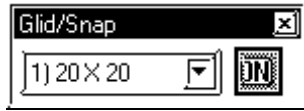

◆ Spacing

The Grid Point intervals are entered here. The unit is a dot. Input the interval value for the X and Y axes, respectively. The default value is 20 dots.

When clicking on [Touch Area], a 20 x 20 dot spacing will be automatically designated, which is most suitable for the touch panel.

Select a desired grid pattern in Spacing and click on the button. Then, the selected grid pattern will be reflected to the current screen and will also be displayed as the 6th selection of the Grid Tool Bar's grid pattern selection list.

◆ Grid Spacing List

Clicking on the button changes Grid Spacing List's highlighted set value to Spacing's set value and registers it.

The grid patterns registered here will be displayed on the Grid Tool Bar's grid pattern selection list box. A grid pattern selected from the grid pattern selection list box will be reflected to the current screen.

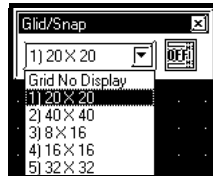

◆ Start Point

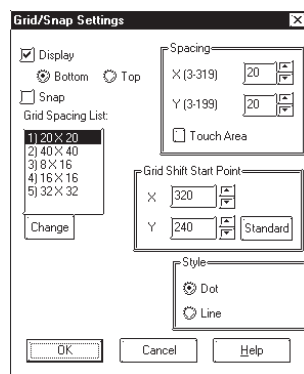

When the GP type is changed to a model that has a different screen size, the start point of the grid is the start point that is set in a center area

◆ Style

Select grid pattern display style from “Dot” and “Line”.

<When selecting Dot:>

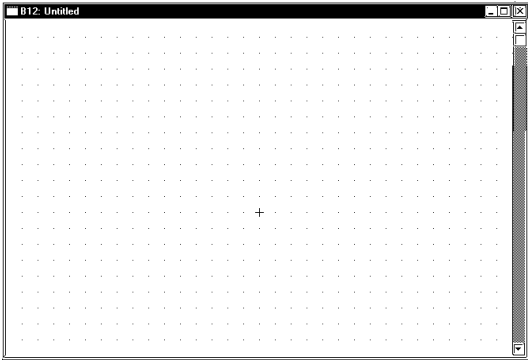

<When selecting Line:>

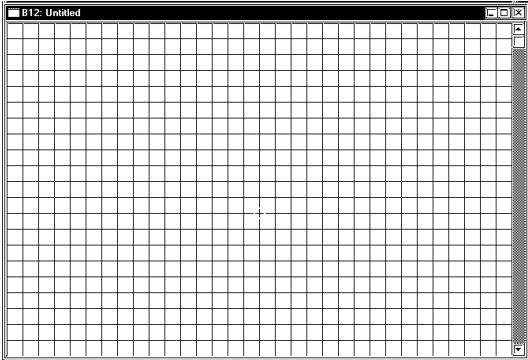

2.8.2 Screen Property Settings

Here, the screen display's environment is set up, which effects both the method used to draw screens and displaying the Part and Tag addresses. The user's work environment can be modified whenever necessary, helping to reduce the time required for drawing.

Select the pull down menu [Option]'s [Screen Property] command.

■ Setting Screen Property - [Display]

The display state (displayed or not) of the items such as object Fill, Window Mark, Tag Mark, and setting information on Tags and Parts can be selected. Check the box of the items to be displayed. When a box is not checked, that item will not be displayed.

The settings on this screen will be applied to all the screens. Properties cannot be set up for individual screens.

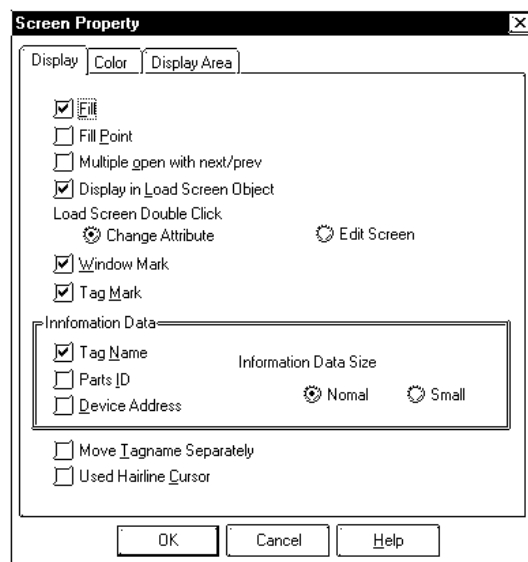

Note: The display state of ID numbers, Tag Names, Addresses, and Tag Marks can also be changed via the [Option] tool bar icons.



◆ Fill

When creating a screen, the drawing can be controlled so that any Fills used will either be displayed or not. If the "Fill" check box is not checked, all Fills are not shown. Using this feature will help you to speed up screen redrawing time, and thus speed up screen creation.



When the "Fill" check box is not checked, the actual screen shown on the GP unit may differ from the screen shown on your PC. To be sure the display is correct, check the "Fill" check box ON at least once, to verify the screen, before sending screen data to the GP.

◆ **Fill Point**

When this feature is selected, specified Fill points will appear with an “X” mark, which is especially useful when selecting Fill points.
If the Fill Points are not displayed, Fill cannot be performed while editing.



Note: The X (cursor position) mark’s color can be designated in the system’s [Color] area.

◆ **Multiple Open with Next/Prev**

When selecting [Previous Screen]/[Next Screen] from the [Screen] menu, or opening a screen with the Open Screen switch , specify whether the next screen is opened with the currently active screen open or after that active screen is closed. Up to 20 screens may be opened continuously.

◆ **Display in Load Screen Object**

You can specify whether tag and part addresses, ID numbers, tag names, and tag marks on a screen which has been called up using the [Load Screen] command are displayed or hidden.

◆ **Load Screen Double Click**

Specify an edit method for editing a screen that has been called up on another screen where the [Load Screen] command was executed, or for editing a screen on the Screen List.

If [Change Attribute] is specified, the Load Screen dialog box will be opened, enabling you to select a screen to be called up (screen number).

If [Edit Screen] is specified, the screen that has been called up will be opened, allowing you to edit the data.

◆ **Window Mark**

Designates the window mark display state, i.e. displayed or not displayed. The window mark shows an area that has been registered as a window.

 **Reference** 3.7 *Window Display, Window(U) Screen and Base(B) Screen*

◆ Tag Mark

Designates whether or not the Tag Mark is displayed while a screen is being drawn. Tag Marks show the point or area specified for a Tag. However, a/A/D-tag marks and G/g-tag's Pie/Half-Pie/Meter Tag marks will always be displayed, no matter what this setting is.

<Example>

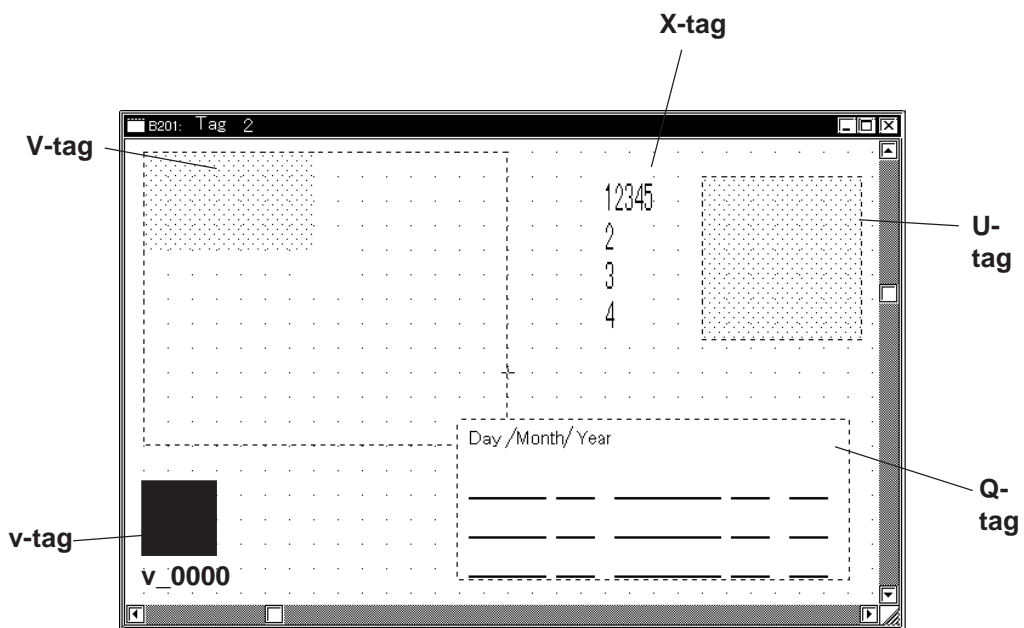
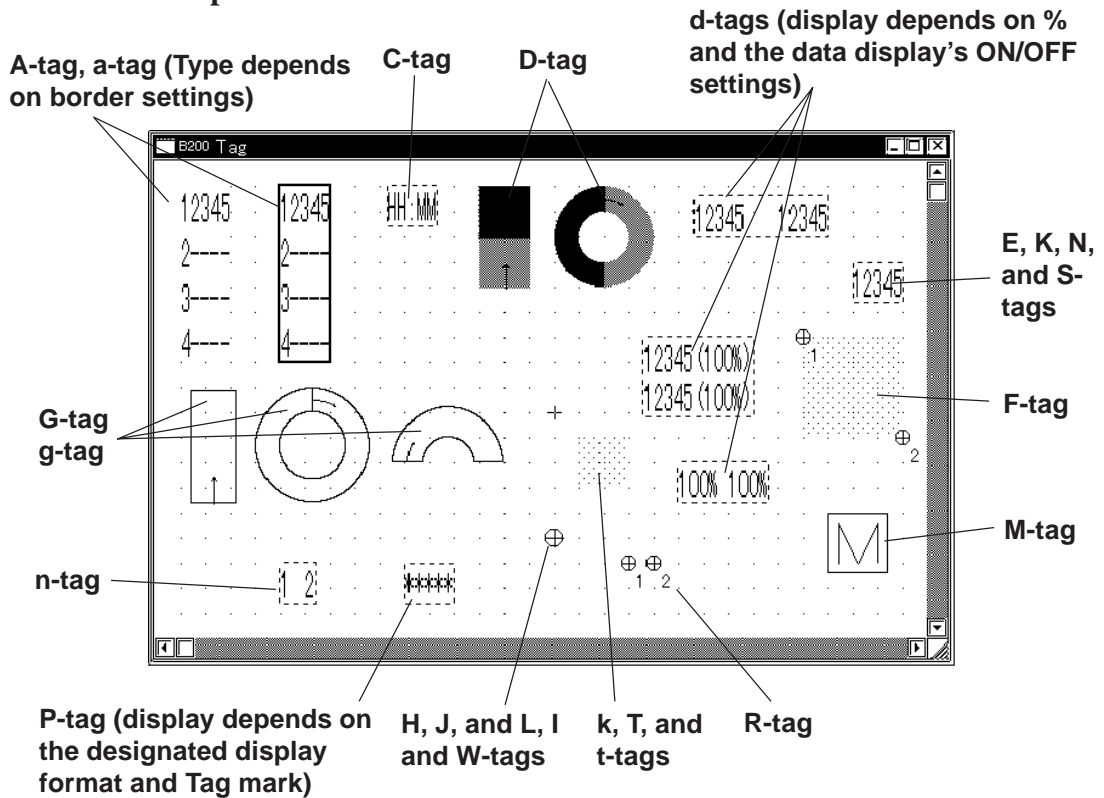

◆ **Tag Name**

Designates whether or not the Tag Name is displayed while a screen is being drawn.

◆ **Parts ID**

Designates whether or not a Part's ID number is displayed on the Base screen.

◆ **Device Address**

Designates whether or not Part and Tag Addresses are displayed on the Base screen. Part Addresses appear below the ID number, and on Tags, below the Tag Name.

◆ **Information Data Size**

Selects the character size displayed from Standard (half size) and Minimized (1/4 size) for ID No., Tag names, and Address.

◆ **Move Tagname Separately**

Whether or not the Tag Name and Address display position is also moved when Tag Marks are moved is designated during screen creation. If this function is selected, when Tag Marks are moved, Tag Names and Addresses will be not moved.

◆ **Used Hairline Cursor**

Changes the arrow cursor to the hairline cursor.

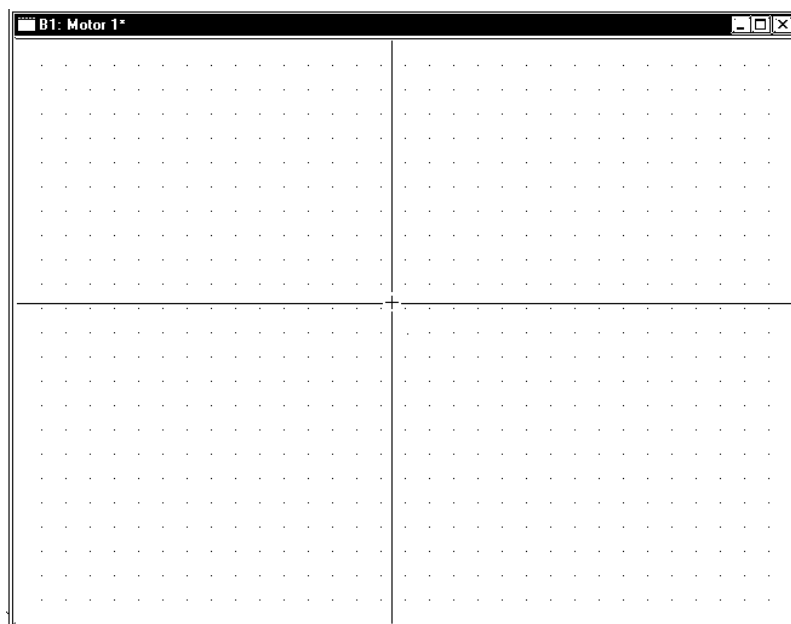

■ Setting Screen Property - [Color]

Select the Grid, Fill Point, and Screen Background colors here. When the drawn image data's and system's colors are the same, the screens will be hard to see. Here, these colors can be changed to remedy that.

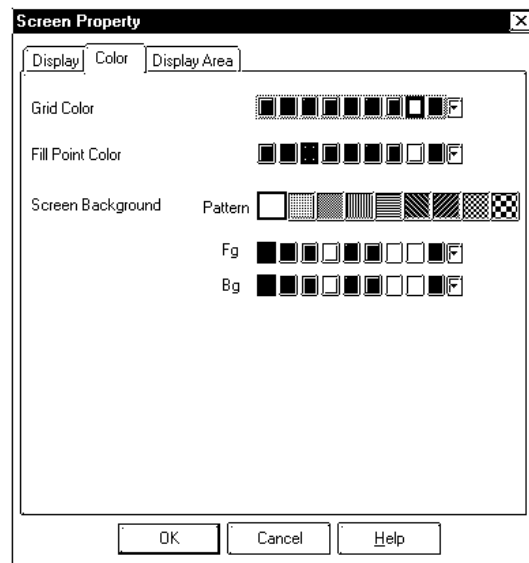

◆ Grid Color

Selects the grid point's color.

◆ Fill Point Color

Fill Points designate the point where a fill will begin; this setting determines the color of the fill point.

◆ Screen Background

Select the Base screen's background color; the color selected here is also displayed on the GP.



- ***If any background color is specified for the screen to be loaded, no on-screen object will be displayed on the GP unit.***
- ***To load a screen whose background color was specified, specify the loading position at the center of the screen.***

■ **Setting Screen Property - [Display Area]**

Select a GP unit with a lower level of resolution than the current one. If the screen display area is different between GP units with different resolution levels, part of the screen may become invalid. With this function, you can confirm the screen area that can be displayed on a different resolution GP unit beforehand.

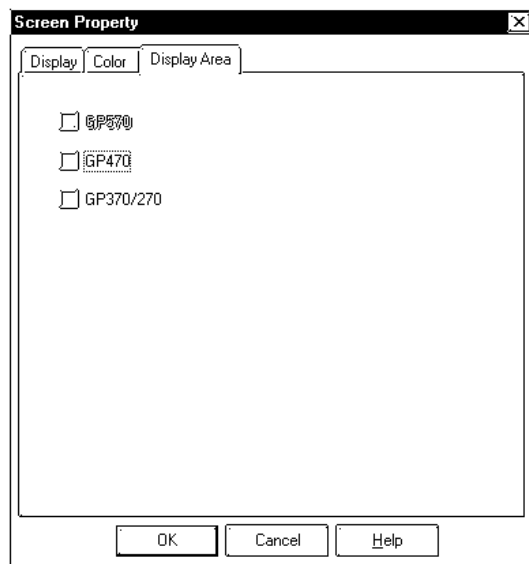

<List of Resolutions>

Display Area Size	Models with the Same Resolution
GP570	GP-570, GP-571, GP-870, GP-577R, GP-2401H, GP-2400, GP-2500, GP-2501
GP470	GP-470, GP-477R
GP370/270	GP-H70, GP-270, GP-370, GP-377, GP-377R, GP-2301H, GP-2300, GP-2301

2.8.3 Preview Screen

With this feature, you can confirm how an image will appear on the GP unit. This image will differ depending on each GP display device type. Select the [Preview] from the [View].

Select the type of display used

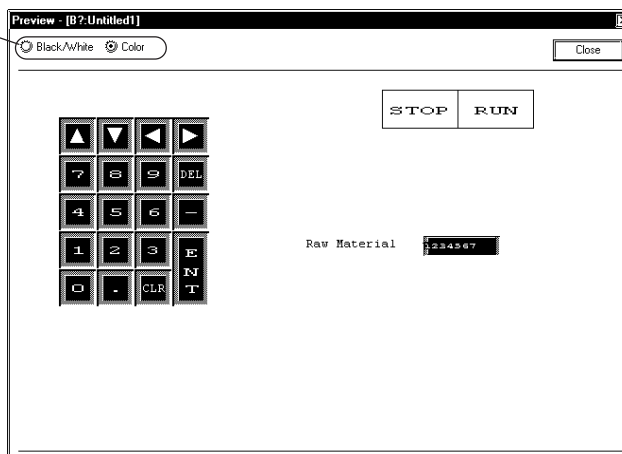

2.8.4 **Screen Data List**

The currently displayed screen’s object locations and setting attributes are listed in the Screen Data List.

■ **Screen Data List**

An example of the Screen Data List is shown below.

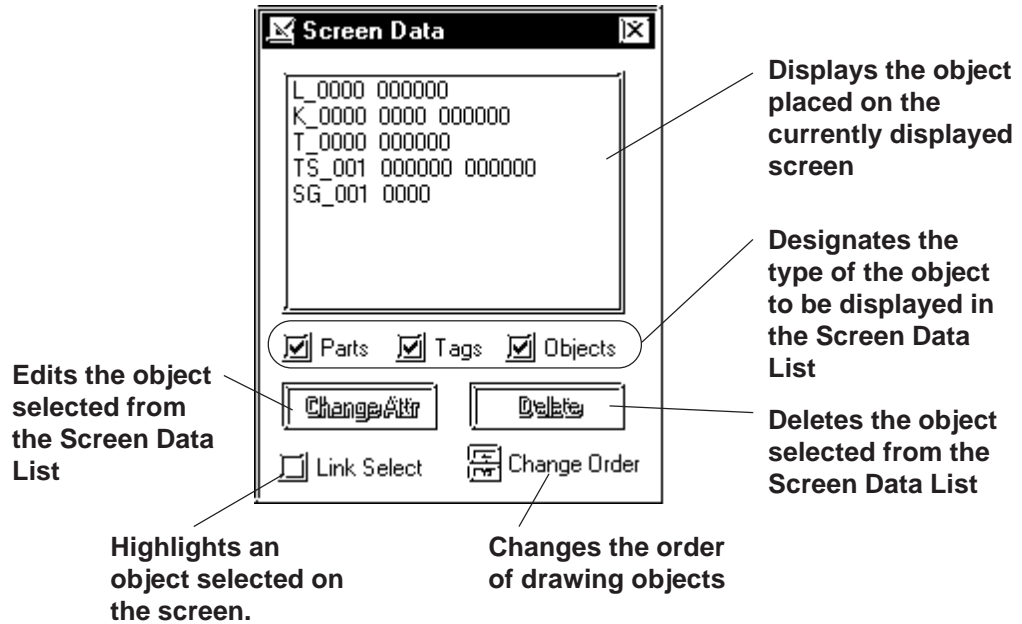

■ **Screen Data Display**

The designated type of object(s) data is displayed. If a grouped object contains at least one object whose type has been designated, it is displayed as an grouped object.

The Screen Data List displays the following information:

- Drawing Type and coordinates of a drawing object
- Tag Tag Name and Address
- Part ID Number and Address
- Grouped object Grouped object’s coordinates and each grouped object’s information

Note: D-Scripts are displayed as tags. Each D-Script shows ID and description information.

■ **Selecting an Object**

The object selected from the list will be displayed with handles (i.e. selected) in the Screen Editor. To select multiple objects from the list, Left-drag them, or hold the [Shift] or [Ctrl] key down and click on desired ones.

◆ **Link Select**

Normally, when any object is selected with the Screen Editor, it will not be displayed on the list. If the check box for [Link Select] is marked, an object selected with the Screen Editor will also be selected (highlighted) on the list.

■ Editing an Object

To edit an object, select it from the list and click on the button; or simply double-click on the object.

If the object is D-Script, D-Script Editor will be actuated.

Clicking on the button deletes the selected object.

◆ Change Order

Objects are displayed on the list in the order where they have been drawn. If the order of objects on the list is changed, the overlapping order of drawn objects and the executing order of tags and parts can also be changed.

◆ Copying

Any object on the list can be copied by pressing the + key, or pasted by pressing the + keys. Multiple objects can be copied at a time by selecting them.

2.8.5 Part Reference List

The settings for each Part placed on the currently edited screen are listed here, for each Part type. Part settings can also be changed on the Part Reference List.

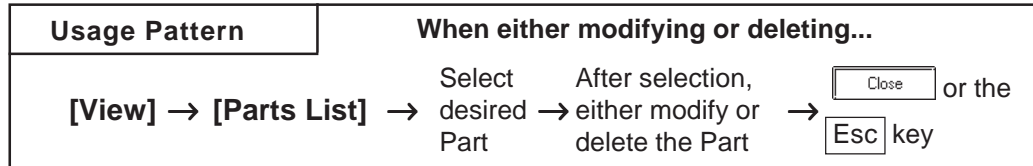

An example of the Part Reference List on a screen is shown below.

Reflection of device comment
The device comment corresponding to an entered device address overwrites the Description field.

Shows a list of the Parts on the currently selected screen. Simply click on the desired Part

Changes Part's settings

Deletes the selected Part

Copies a part

Pastes a part

Stores the Parts list information as a CSV file.

Use this scroll bar to view all the data on a long screen

Closes the current screen. (The **Esc key can also be used)**

Part ID	Description	Data Address	Display M.	Data Format	Bit Length	Input Code	Min. Value	Max. Value	Edit
1	BA_001	Run Test	000000	+	Abs. Bin
2	BA_001	Run Test	000000	+	Abs. Bin
3	BA_001	Run Test	000000	+	Abs. Bin



Note: The tab width for each item can be adjusted by placing the mouse pointer on the border between items and then dragging it.

■ Editing Items on the Part Reference List

Part setting data can be changed directly on the Part Reference List. Click on the left-most number of a Part to be changed, and it will be highlighted; then, click on the button, and the Part's Dialog box will appear and its settings can be changed. Setting items, such as the Description and Address areas, can be changed via the Part Reference List. Also, items displayed in gray can be changed in the dialog box by double-clicking on the inside of their border.

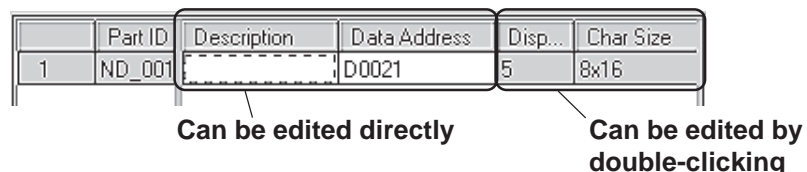



Note: For the labels and messages of more than one line, use “\” as the carriage return.

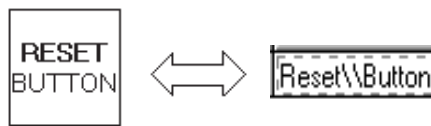

■ Deleting Items from the Part Reference List

Parts can be deleted directly from the Part Reference List.

Click in the middle of a Part to be deleted, and it will be highlighted. Then, click on the button, and a dialog box will appear. Clicking on the button will delete the Part from the Part Reference List. To close the box without deleting the Part, click on the button. When multiple Parts are selected, all the Parts will be deleted by clicking on the button, and by clicking on the button, the box will be closed.

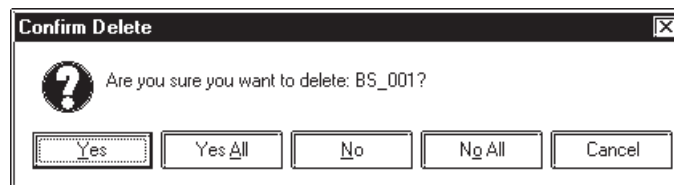

■ Copying a Part on the Parts List

Any part can be copied on the parts list.

Select the left-most number for the part being copied by clicking on that number. The selected part will be highlighted. After this selection, click on the button and then the button. The part will be copied to the bottom line of the list.

■ Reflecting a Device Comment on the Parts List

The device comment corresponding to an entered device address can be entered on the parts list by clicking on a specified button. This can be done in either of the following two ways:

1. Select the address setting field and click on the [Apply Device Comment] button.

The device comment corresponding to the selected address will be reflected in the Description field.

2. Select a part by its line and click on the [Apply Device Comment] button.

If there are multiple address setting items for that part, the description corresponding to the address specified in the [Address Table for Automatic Input of Device comment] will be reflected in the Description field.

▼ Reference 2.4.7 ◆ Reflection of Device Comments

■ Exporting a CSV File

The Parts list information can be saved as a CSV file.

You can also select whether the currently selected page (tab)'s information will be exported or the entire page will be exported.

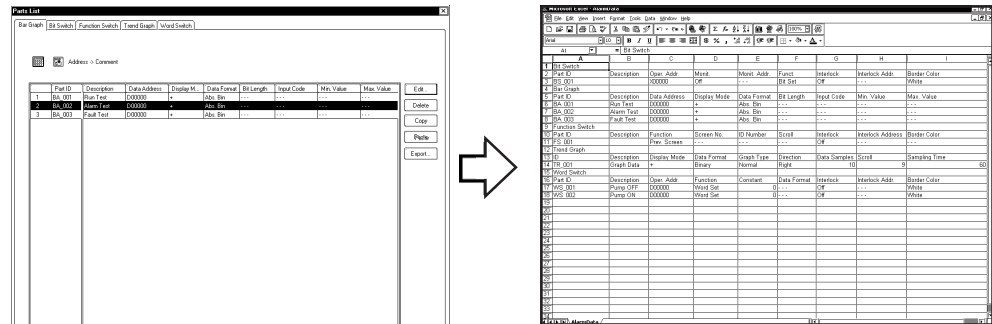

2.8.6 Tag List

Tags and their setting attributes (type of data) specified on the current screen or in a Project File can be listed; the setting attributes can also be changed on the Tag List. The Tag List will be displayed separately for Local Setting (Tags specified for each screen) and for Data Sampling Settings specified commonly for all the screens. When using a Handy-type GP (GP-H70/GP2000H series) unit, the Global function keys will also be displayed. The Tag List for Local Setting and Tag data setup for each screen will be displayed.

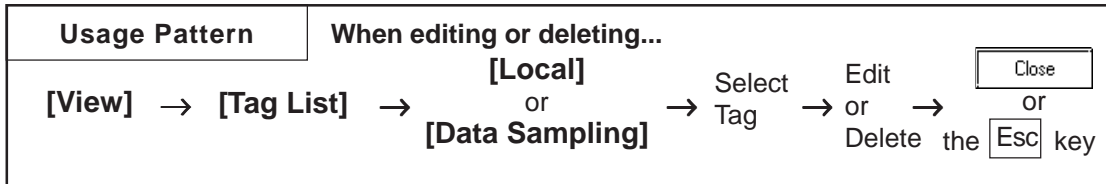

The following is the Tag list (local) screen example.

The edit method of this list is the same as that of the Parts list.

Reference 2.8.5 Part Reference List

Lists all the Tags used on the currently open screen. Select the desired Tag to list its type of data

Opens the selected Tag for editing

Deletes the selected Tag

Copies Tag

Pastes Tag

Moves Tag one position higher on the list

Moves Tag one position lower on the list

Using Device Comment
Here, the device comment that corresponds to an device address is automatically written in the Description field.

Click on [Close] to close the Tag List screen. Pressing the [Esc] key will also close the screen

If Tag has been grouped, an asterisk will appear here.

Tag	Description	Grouped	Edit
1	A_0001 Alarm Summary		
2	C_0001 Time Summary		
3	G_0001 Pump ON		
4	n_0001 Motor Test		

Reference 2.4.12 Group/Ungroup

<Individual Tag List Screen>

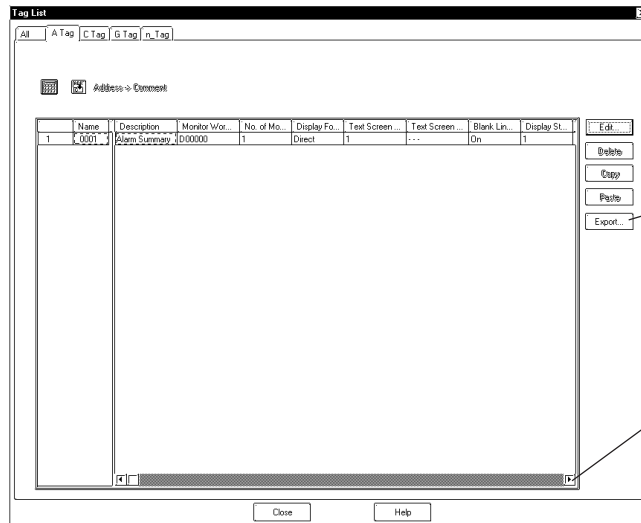

Saves the Tag List in a CSV file

Scrolls the display left, right, up and down when the Tag List is bigger than the screen size



- Note:**
- The tab width for each item can be adjusted by positioning the mouse pointer on the border between items and then dragging it.
 - For Handy-type GP (GP-H70/GP2000H Series) unit, the Tag names specified via the Local function keys will become “OP_ * _****” or “F* _ * _****”, thereby allowing you to distinguish in the Tag List whether the Tag was set up via the Local function keys or on the screen.

Reference 2.9.1 Function Keys

■ Changing the Tag Setting Order

The Tags will function in the order that they have been set up (the order displayed on all the pages of the Tag List) on the GP screen. To change this order, click on either the **Move Up** or **Move Down** key. When multiple Tags are grouped, that group will be moved up or down.

■ Exporting a CSV File

The Parts list information can be saved as a CSV file.

You can also select whether the currently selected page (tab)’s information will be exported or the entire page will be exported.

Reference 2.8.5 Part Reference List ■ Exporting a CSV File

2.8.7 Cross Reference List

The Cross Reference List feature is useful when displaying the current address condition of Tags and other items. Here, the exact address used for each Tag can be checked.

Cross reference will be displayed for local settings (each screen's Tags, D-scripts, and Parts), and data sampling and global D-scripts registered for all the screens. If you use the Handy-type GP (GP-H70/GP2000H Series) unit, the global function key settings will also be displayed. For the global cross reference, setting display will not be sorted for each functions and screens, but the address designation conditions will be displayed for the entire Project File.



- Since, to display the global cross reference, address information for all the screen will be acquired, it can take a long period of time.
- The global cross reference does not display the condition of addresses that have been designated via [GP System Settings].
- After changing the GP model (GP type), addresses specific to the previous GP model (type) may be displayed. (For example, when changing GP-H70/GP2000H Series to the other model, this may occur.)

■ Cross Reference (Local, Data Sampling, Global D-script)

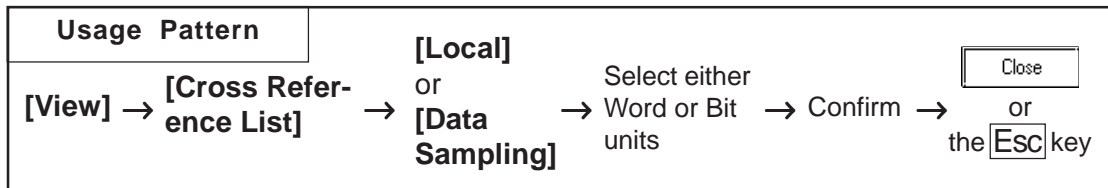

An example of the Cross Reference List dialog box (in the case of Local) is as shown below.

Select whether to display by Bit Address or Word Address

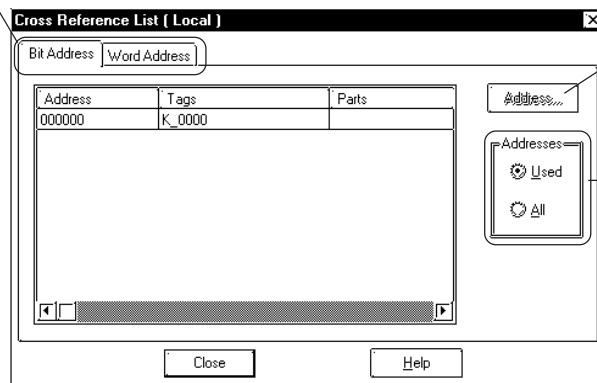

Click to change the Display Start Address

Selects the Address Display condition

■ **Global Cross Reference**

The global cross reference has two display methods, i.e. list display same as the standard cross reference and address map display.

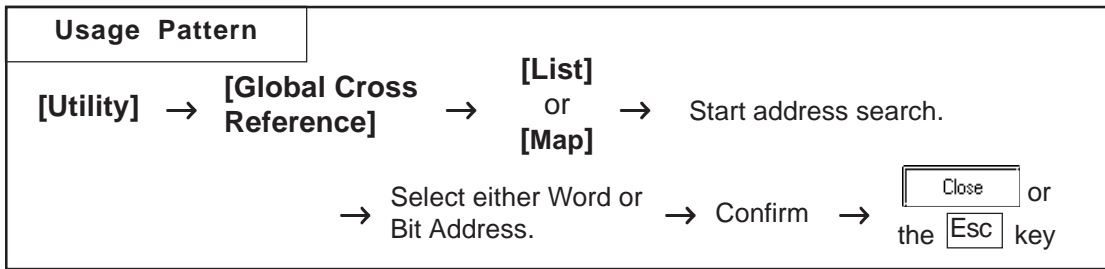

The following is the overview for the global cross reference screens.

◆ **List Display**

For local settings, which screen is used, and for global settings, function type will be displayed, respectively.

Selects whether setting conditions are displayed for Bit Addresses or for Word Addresses.

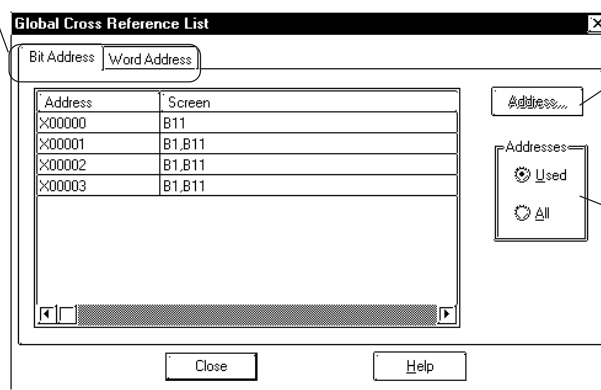

Changes the display start address to be displayed.

Selects the range of Addresses to be displayed.

◆ **Address Map Display**

When selecting Word Address, the table cells from Word Address Bits 0 to 15 (for 32 bit device, from 0 to 32) will all be filled. When selecting Bit Address, only bit cells currently used will be filled.

Selects whether setting conditions are displayed for Bit Addresses or for Word Addresses.

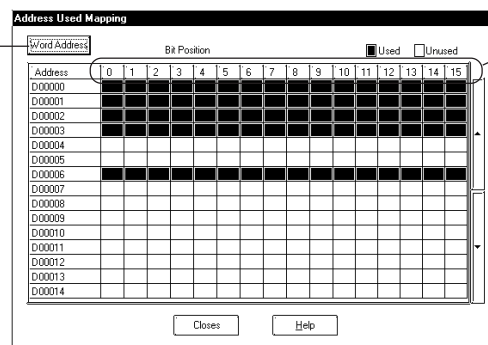

Displays the Bit location.



- Among the tags and parts, the ones corresponding to both bit addresses and word addresses are cross-referenced with both of those addresses on the Cross Reference List even if they were placed by specifying their bit addresses.

Example: A tag (part) placed at bit address, X0000F is displayed as word address, X00000.

- In the case of the Handy-type GP (GP-H70/GP2000H Series) unit, tag names on the setting list can be used to distinguish tags added with local function keys from ones added on screens. The tags added with local function keys are named as “OP_*_*_*_*” or “F*_*_*_*_*”.

▼ Reference ▲ 2.9.1 Function Keys

■ Changing Display Addresses

For cross reference and global cross reference list display, when selecting [Used], addresses that have been used for the Tags and Parts used in the currently open screen or Project will be displayed. When selecting “All Addresses”, all the addresses beginning with the Start Address will be displayed. To change the Start Address, click on the button, and the Dialog box shown below will appear. Set the Start Address and click on the button, and the display will show from that address on.

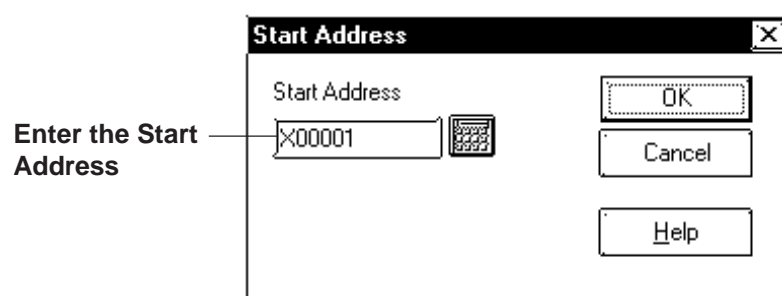

For the global cross reference’s address map display, the map display start address can be designated when toggling Bit and Word display.

When clicking on or , the following dialog box will appear. After selecting Bit or Word, designate the start address. Then, click on the button and the cross reference display will start from the designated start address.

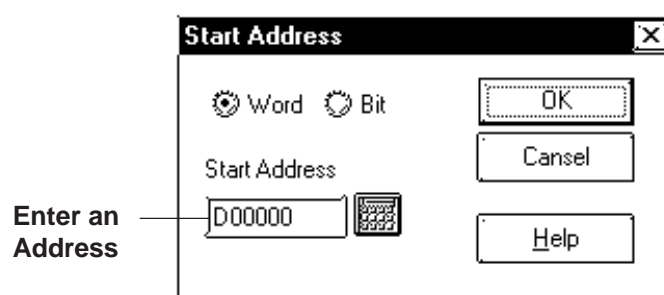

2.8.8 Load Screen List

The Load Screen List will be displayed on the currently edited screen. With this list, you can check the setting attributes of a screen to be loaded and also can change its loading location.

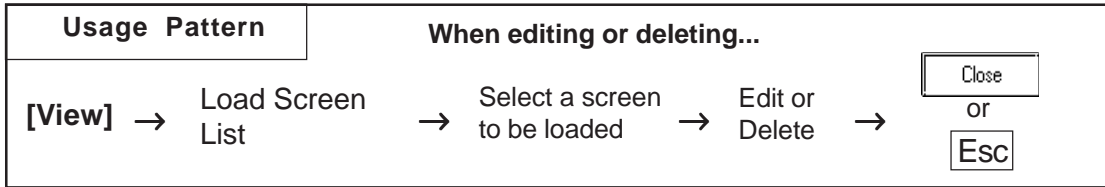

General Load Screen Summary List

Lists all the screens loaded on the currently open screen. Select the desired screen to show its setting attributes.

Click on to close the Load Screen List screen. Pressing the **ESC** key will also close the screen

Changes Load Screen List Settings

Deletes a Load Screen List

Scr.	Position X	Position Y	Title	
1	2	195	53	Line A
2	3	305	81	Statistics A
3	4	265	182	Alarm A

■ **Editing via the Load Screen List**

Screen settings can be changed using the Load Screen List. Clicking on the left-most number of a screen to be changed will select (highlight) it. Then, clicking on the [Edit] button will bring up the [Load Screen] dialog box or the currently called-up screen, allowing you to edit the screen. The procedure for calling up and then editing a screen varies depending on the settings in the [Load Screen Double Click].

▼ **Reference** 2.8.2 ■ *Setting Screen Property - [Display]*

Any coordinate setting can be changed directly via the Load Screen List.

■ Deleting from the Load Screen List

Screens can be deleted from the Load Screen List.

Clicking on the left-most number of a screen to be changed will select (highlight) it. To delete multiple Load Screen Lists simultaneously, simply drag the cursor to select the screen numbers. Then, click on the button, and the dialog box will appear to confirm the command. If you click on button, the screen will be deleted. To cancel the request, click on the button. When selecting multiple screens, click on the to delete all of them, and click on to cancel any deletions.

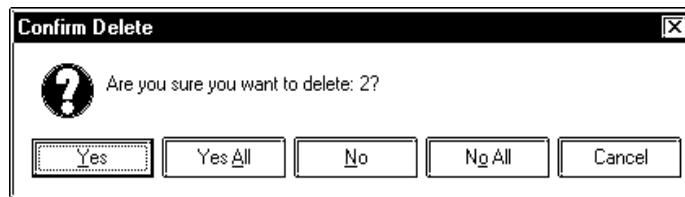

2.8.9 Display of Screen Level Change Structure

The nesting of Load Screens that have been set up on the currently edited screen is displayed. In this way, a multiple nesting condition can be viewed.

Reference 2.2.10 Load Screens ■ Nesting

Select the [View] menu - [Load Screen Nesting Display] command.

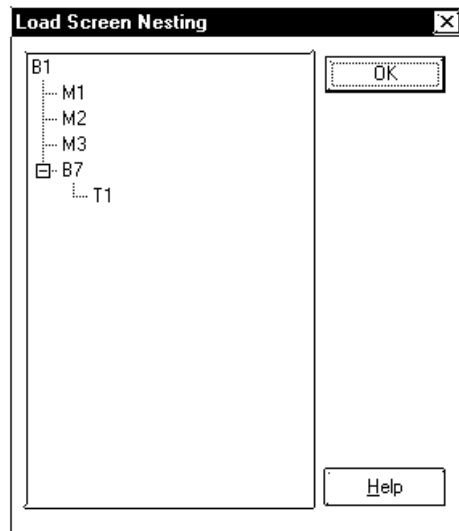

Each screen will be displayed via the following symbols:

Screen Type	Symbol
Base screen	B
Mark screen	M
Trend Graph screen	T
Keypad screen	K
Image screen	I
Image screen - CF card	I(CF)
Window screen	U

2.9 Creating Handy-type GP Screen

The following screens are for the GP-H70/GP2301H and GP2401H units.

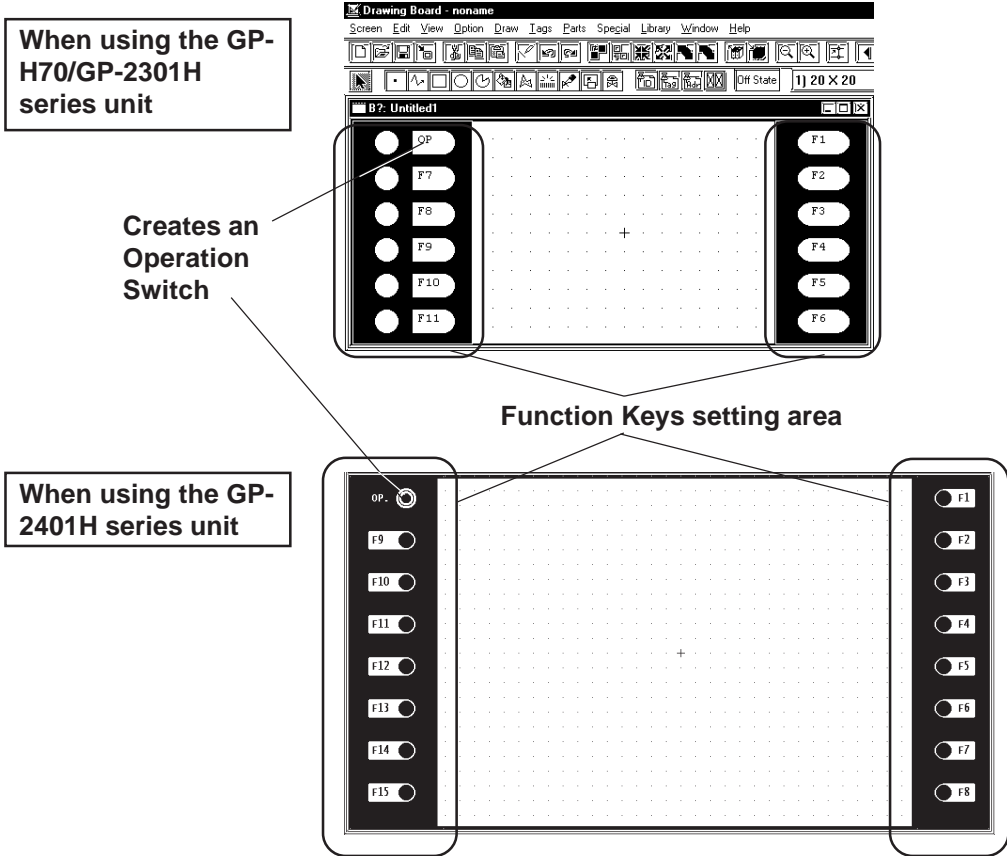

2.9.1 Function Keys

There are Function Keys on each side and you can set up each one as a Tag (T-tag, t-tag, k-tag) for touch input. GP-H70/GP-2301H series has six Function Keys and GP-2401H series has eight keys on each side.

These Function Keys can be specified for Local Use or Global Use. With the Local Function Key Setup, the Function Keys are only used by the designated screen. With the Global Function Key Setup, the Function Keys are commonly used by all screens.

The number of Tags that can be registered on a GP panel as Global Function Keys is limited to a total of 24 T, t and k-tags.

The following Tags together with other Tags designated on the screen can be used for a single screen's Local Function Keys (except the Tags designated for Function Keys).

GP-H70 series :128

GP2000H series :384

Registering a single t-tag as a Global Function Key, however, requires 2 Tags.

If a Function Key is set up for both Global and Local use, then the Tags specified as Global will be performed first.

All Tags registered as Function Keys cannot use the AUX output or Reverse Video features.

■ Function Key Settings

An example of the Function Key Setting screen is shown below.

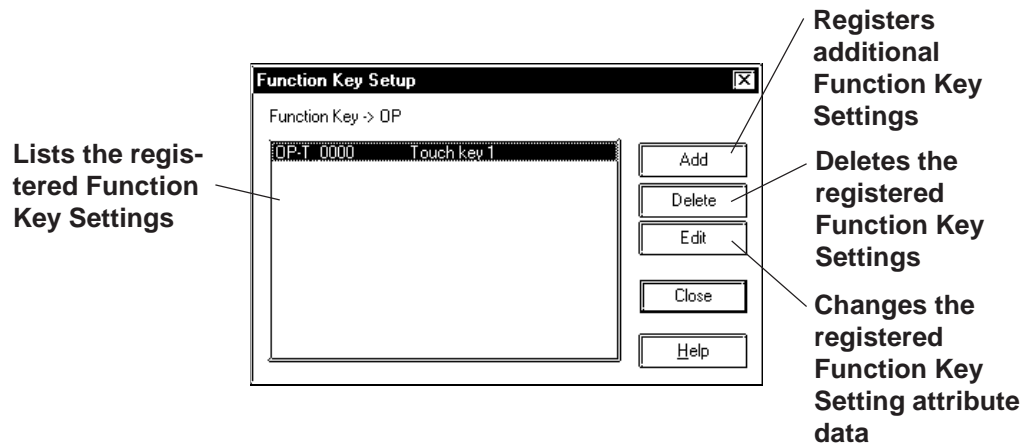

■ Setting Up Local Function Keys

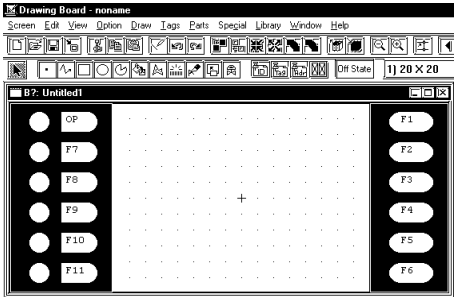
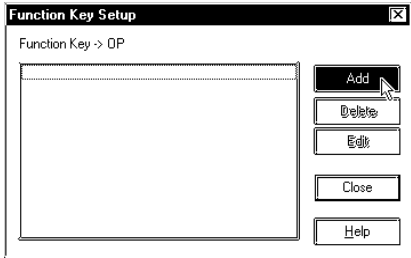
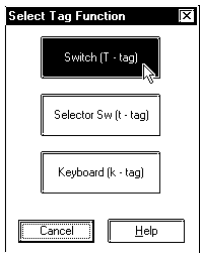
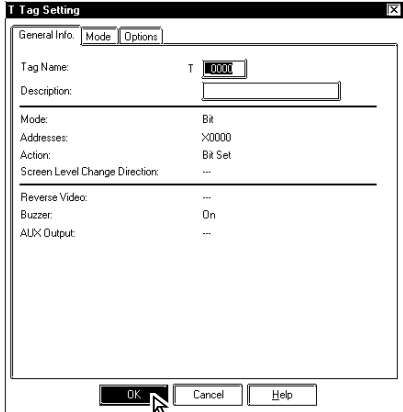

The Local Function Key Setting procedure is described. An example of using the GP2301HL/GP2301HS is as follows.

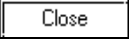
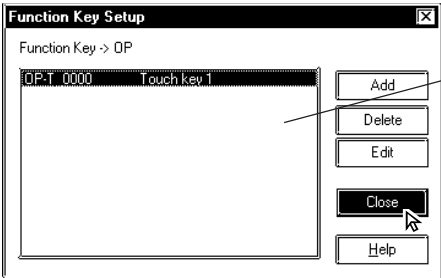
PROCEDURE	REMARKS
<p>(1) Double-click on any of the Function Keys displayed.</p>  <p>When using the GPH70L/GPH70S/GP2301HL/GP2301HS series</p> <p>(2) Click on the [Function Key Settings] screen's Add button.</p>  <p>(3) Click on the Tag Name to be used.</p>  <p>(4) Enter the Tag setting data. After all the attributes have been entered, click on the OK button to register the entered data.</p> 	<p>When using the GP-2401H series unit, there are eight Function Keys including the Operation switch on each side .</p> <p>Multiple Tags can be assigned to a Function Key; however, there is a limit to the number that can be used.</p> <p>Reference For details of each Tag's setting data, refer to the <i>Tag Reference Manual, Chapter 2 Active Image Functions</i></p>

PROCEDURE	REMARKS
<p>(5) Click on the  button to quit the Function Key registration.</p>  <p style="margin-left: 200px;">Displays the registered item</p>	<p>To register another item, DO NOT quit here, rather start again from step (2).</p>

■ Setting Up Global Function Keys

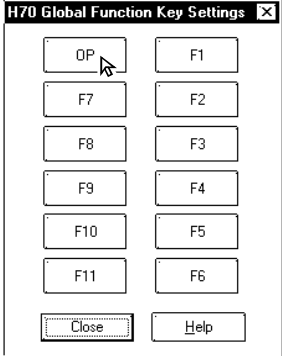
The Global Function Key Setting procedure is described. An example of using the GP-H70/GP-2301H series is as follows.

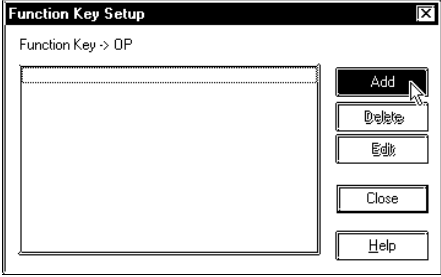
PROCEDURE	REMARKS
<p>(1) Click on the [Special] menu's [Global Fn Key].</p> <p>(2) Double-click on any of the Function Keys displayed.</p>  <p>When using the GP-H70/GP-2301H series</p> <p>(3) Click on the  button.</p> 	<p>Before this selection, open any Base screen.</p> <p>When using the GP-2401H series unit, there are eight Function Keys including the Operation switch on each side .</p>

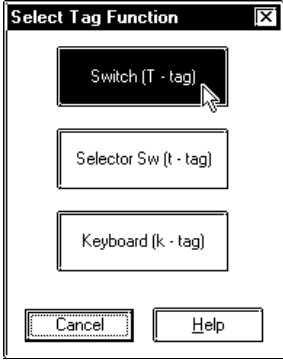
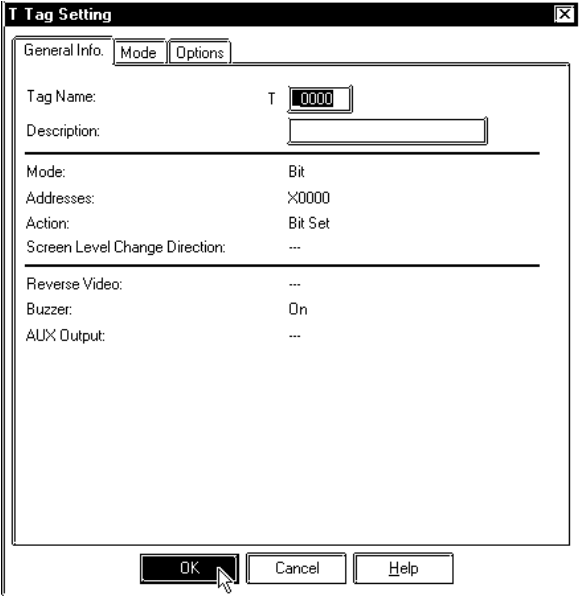
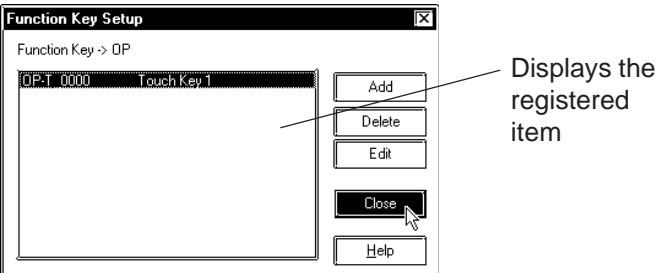
PROCEDURE	REMARKS
<p>(4) Click on the Tag Name to be used.</p>  <p>(5) Enter the Tag setting data. After all the attributes have been entered, click on the <input type="button" value="OK"/> button to register the entered data.</p>  <p>(6) Click on the <input type="button" value="Close"/> button to quit the Function Key registration.</p> 	<p>Multiple Tags can be assigned to a Function Key, however, there is a limit to the maximum number.</p> <p>Reference For details of each Tag's setting data, refer to the <i>Tag Reference Manual Chapter 2 Active Image Function</i>.</p> <p>To perform the registration continuously, DO NOT quit here, start from step (3) again.</p>

■ Notes for the Function Keys

If changing your GP type from GP-2401H series (16 Function Keys) to GP-H70/GP-2301H series (12 Function Keys) or vice versa, some keys may be shifted from the designated place due to the difference of Function Keys.

2.9.2 Setting Up the Operation Switch

This section describes the procedures for setting up the Operation Switches supported by the GP-H70/GP2000H series.

The features of the Operation Switch are as follows:

- (1) An Operation Switch can be used as a Function Switch.
- (2) An Operation Switch can be used to enable Inputs from the touch panel and Function Keys.

For details of feature (1), see the setup procedures in Section 2.9.1 "Function Keys."

Feature (2) is activated only when the Operation Switch is enabled. The procedure for enabling the Operation Switches is described below. If the Operation Switches are disabled, only feature (1) is available.

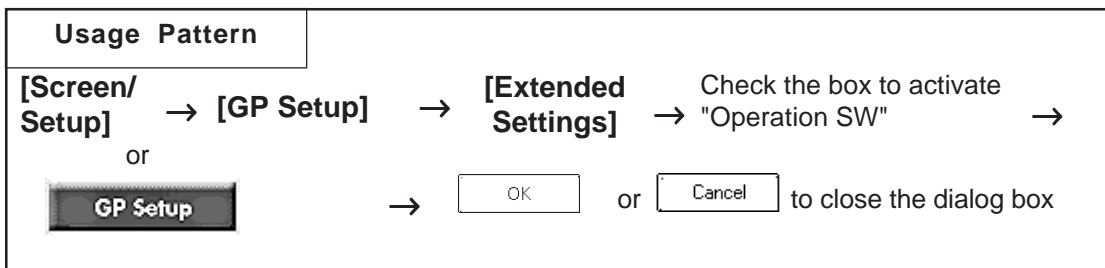

• The function of the Operation Switch can be "enabled" or "disabled" in the GP's OFF-LINE mode. Refer to GP-H70 Series User's Manual/GP2000H Series User's Manual.

■ **Setting Up the Operation Switches with the GP-H70**

◆ **The Position of the switches**

The GP-H70 has two Operation Switches; one on the front face and one on the rear face.

<Front View>

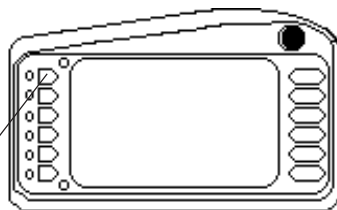

Front Face Operation Switch

<Rear View>

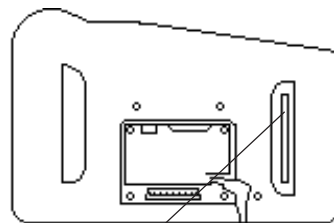

Rear Face Operation Switch

◆ **Default Settings of the switches**

According to the default settings of the GP-H70, both Operation Switches are enabled with the dialog box below.

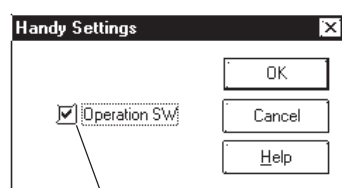

The "Operation SW" is checked by default.



- If the Operation Switches are enabled, do not hold down both the front Operation Switch and rear Operation Switch simultaneously when performing touch input. Doing so disables touch input. Make touch input while holding down only one of the switches.

■ Setting Up the Operation Switches with the GP2000H

◆ Positions of the switches

The GP2000H has one Operation Switch on the front.

<Front View>



◆ Default Setting of the switch

According to the default settings of the GP2000H, the Operation Switch is disabled. When the GP is operated under the default settings, the inputs from the touch panel and Function Keys are enabled.

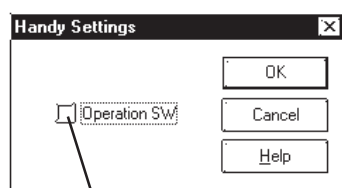

The "Operation SW" is unchecked by default



- The GP2000H and the GP-H70 differ in the number of Operation Switches and the default settings of the switches. Note this difference when switching from the GP-H70 series to the GP2000H model.

■ Settings for Using the GP2000H Series in GP-H70 Standard Mode

This setting allows you to use the switch located on the rear of the GP2000H series as an Operation Switch. Change the hardware settings of the GP2000H and select "GP-H70 Standard Mode."

Reference For detailed procedures on setting up the hardware, refer to *the GP2000H Series User's Manual*.

To ensure that inputs from the touch panel and Function Keys are entered only when the Operation Switches are being pressed, change the default setting and select the "Enable" setting option of the Operation Switch.



- The switch located on the rear of the GP2000H can be pressed down in two positions. Pressing down the switch firmly to the second position disables the touch inputs. Be sure to press down the switch to the first position only.

2.9.3 Vibration Function

This function activates the internal motor of the GP to generate a vibration. This is a global function for all screens. Up to sixteen Global Vibration settings can be set up within a single Project.

Note: · Only the GP2000H series supports the Vibration Function.

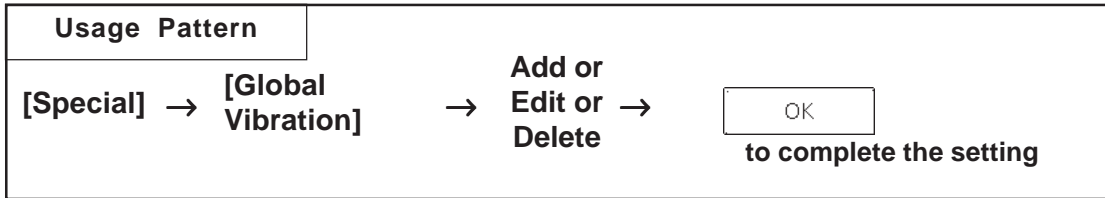

Below is a brief description of the Global Vibration Screen.

Displays the Monitor Address and Descriptions of the registered Global Vibration settings in a list.

Address	Description
X00000	X00000
X00000	D00000

Register a new Global Vibration.

Modify the settings of Global Vibration.

Copy a Global Vibration.

Paste the Global Vibration that was copied.

Delete the registered Global Vibration.

■ **Setting Up Global Vibration with the Bit Address**

This section briefly describes the Global Vibration Screen when the "Bit Address" is being designated for the monitoring function.

The screenshot shows the 'Global Vibration Setting' dialog box with the following fields and options:

- Description:** A text input field.
- Bit/Word:** Radio buttons for 'Bit' (selected) and 'Word'.
- Bit address:** A text input field containing 'X00000' and a numeric keypad icon.
- Trigger:** Radio buttons for '0->1' (selected) and '1->0'.
- Vibration pattern:** Radio buttons for 'Continuous' (selected) and 'Interval'.
- Vibration time(Auto off time):** A text input field containing '10' and a numeric keypad icon.
- Buzz:** A checkbox that is currently unchecked.
- Buttons:** 'OK', 'Cancel', and 'Help' buttons at the bottom.

Callout annotations point to the following elements:

- 'Select the address to be monitored.' points to the 'Bit address' field.
- 'Enter the bit address for activating the vibration.' points to the 'Bit address' field.
- 'Enter the vibration conditions.' points to the 'Trigger' radio buttons.
- 'Select the operation mode for the vibration.' points to the 'Vibration pattern' radio buttons.
- 'Enter a description as necessary.' points to the 'Description' field.
- 'Designate the duration of the vibration. (Available range: 1 to 60 seconds)' points to the 'Vibration time' field.
- 'Enable/Disable the buzzer.' points to the 'Buzz' checkbox.

◆ **Mode**

Select either the Bit Address or Word Address for the device to be monitored.

◆ **Address**

Enter the Bit Address used to trigger the Global Vibration here.

◆ **Trigger Type**

Designate the condition that triggers the vibration. Select "0 to 1" to trigger the vibration when the bit makes the 0-to-1 transition; select "1 to 0" for the opposite condition.

◆ **Vibration Pattern**

Select either Continuous or Interval mode for the vibration pattern.

- Continuous: The vibration continues for the period specified under the "Vibration time" option without interruption.
- Interval: The vibration repeatedly activates for 0.5 seconds followed by a 0.5 second pause for the period specified in the "Vibration time" option.

Example:
Vibration time: 3 seconds

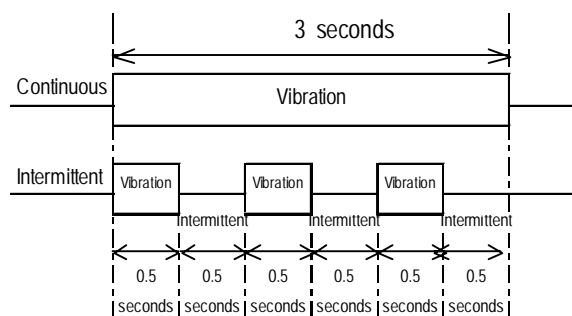

◆ **Vibration time (Auto OFF time)**

Specifies the duration of time after the vibration has been triggered.

The available range is from 1 to 60 seconds. The default setting is 10 seconds.

◆ **Buzzer**

When this option is enabled, the buzzer sounds according to the selected Vibration Pattern.

The buzzer will not sound if "Touch Buzzer Sound" is disabled in [System Setup] under the Project Manager's  window, even when the "Buzzer" function is enabled here.

■ **Setting Up Global Vibration with the Word Address**

This section briefly describes the Global Vibration Screen when the "Word Address" is being designated for the monitoring function.

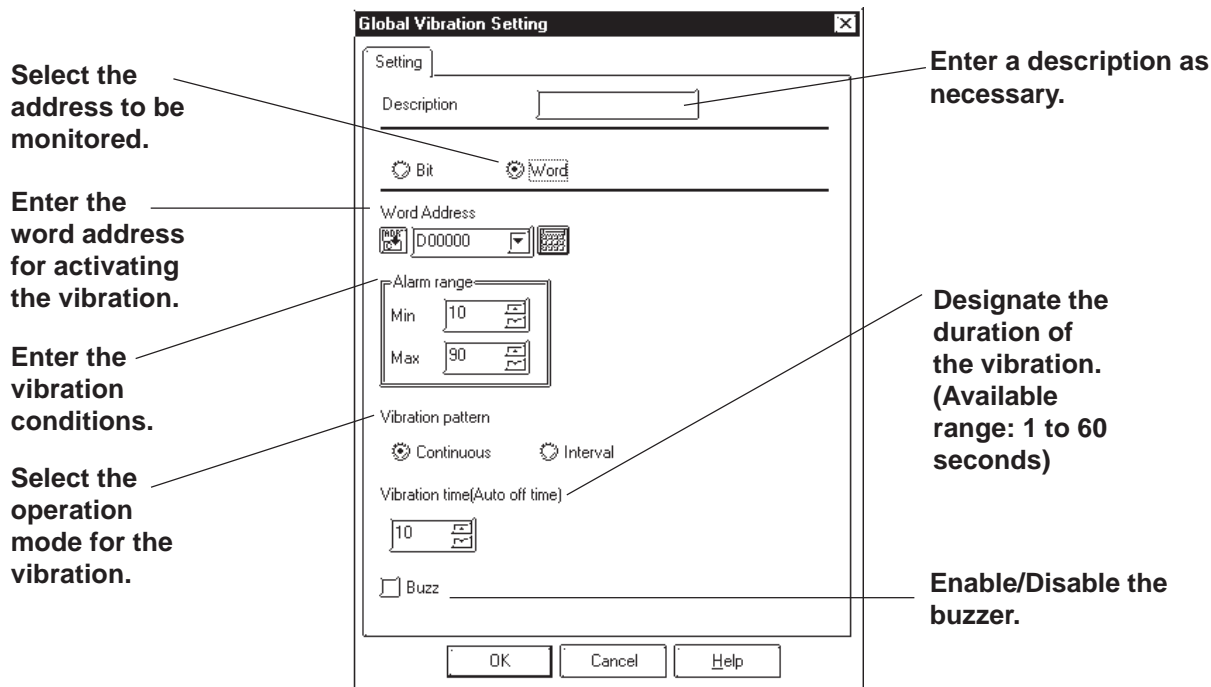

◆ **Mode**

Select either the Bit Address or Word Address for the device to be monitored.

◆ **Address**

Enter the Word Address used to trigger the Global Vibration here.

◆ **Alarm Range**

The vibration is triggered when the value of the word address being monitored exceeds the specified range. The Word Address is 16 bit, unsigned.

◆ **Vibration Pattern**

Select either Continuous or Interval mode for the vibration pattern.

- Continuous: The vibration continues for the period specified under the "Vibration Period" option without interruption.

- Interval: The vibration repeatedly activates for 0.5 seconds followed by a 0.5 second pause for the period specified in the "Vibration Time" option.

Example:
Vibration time: 3 seconds

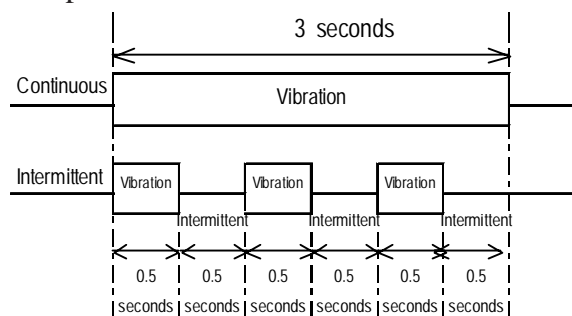

◆ **Vibration time (Auto OFF time)**

Specifies the duration of time after the vibration has been triggered.

The available range is from 1 to 60 seconds. The default setting is 10 seconds.

◆ **Buzzer**

When this option is enabled, the buzzer sounds according to the selected Vibration Pattern.

The buzzer will not sound if "Touch Buzzer Sound" is disabled in [System Setup] under the Project Manager's  window, even when the "Buzzer" function is enabled here.

■ **Vibration Modes**

Operation examples of vibration*¹ are shown below.

- 1) The vibration of the GP unit is triggered according to the settings when the specified Condition is satisfied*².

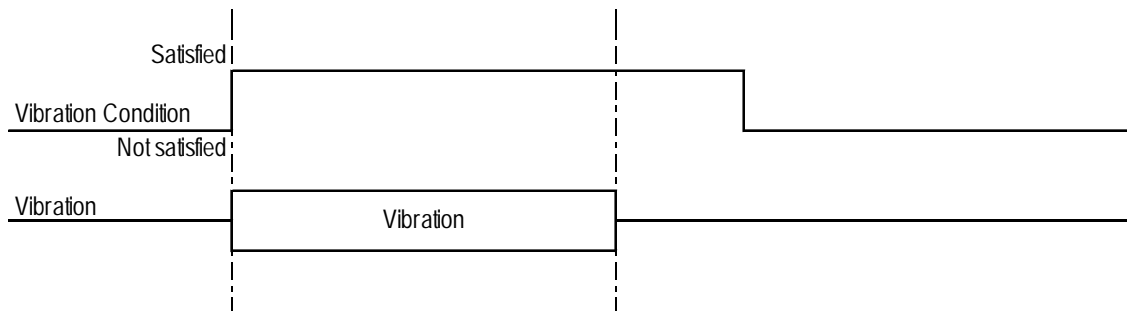

- 2) The vibration is not triggered a second time even if the Vibration Condition is satisfied again while the vibration is ON.

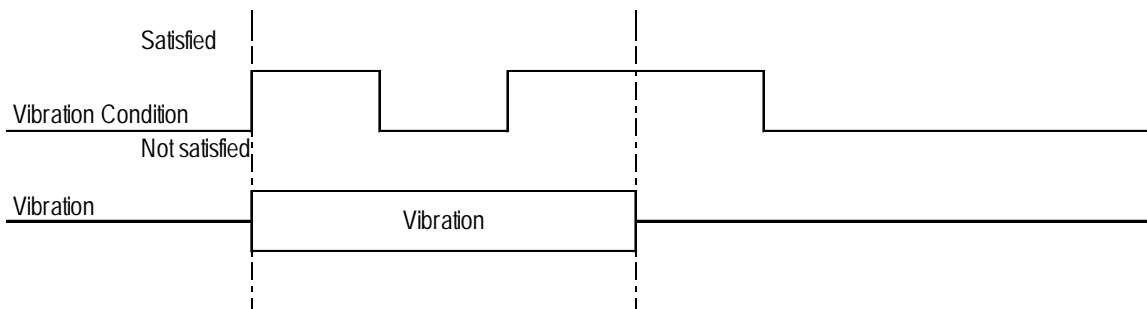

*1: The vibration continues for the period specified in the "Vibration time" option in the [Global Vibration Settings] dialog box. The vibration is triggered when the Vibration Condition is satisfied regardless of the period required for the vibration to be completed, automatically stopping after the specified period has elapsed.

*2: To trigger two consecutive vibration responses, hold the Trigger OFF time (the state in which the Vibration Condition is not satisfied) for the longer of the following two periods: the communication cycle time or the tag scan time.

3) The vibration in response to Vibration Condition (2) is triggered after the vibration in response to Vibration Condition (1) ends.

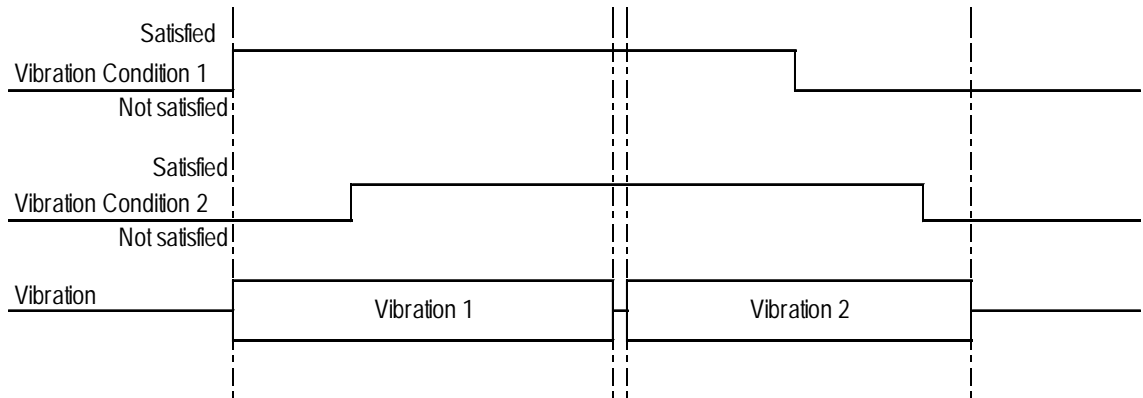

4) If Vibration Condition (2) is not satisfied, no vibration is triggered after the vibration in response to Vibration Condition (1) ends

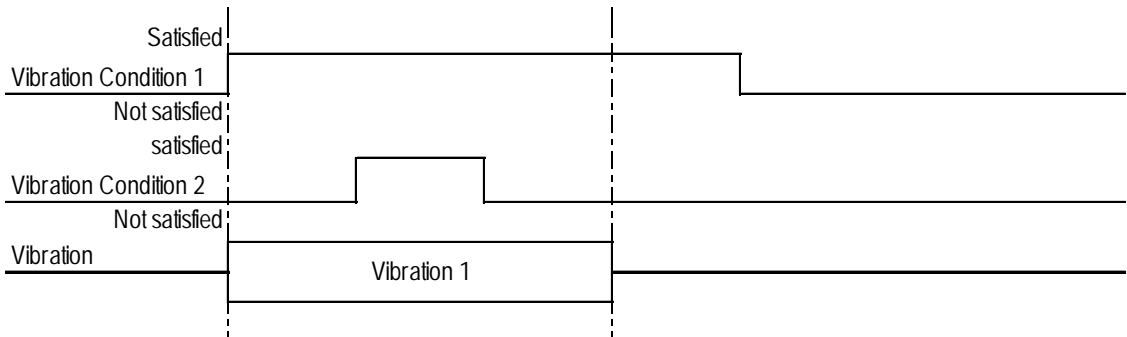



- If two or more Vibration Conditions are satisfied at one time, vibrations are triggered in the sequence specified in the settings. However, note that the vibration may not be activated in the sequence specified with the GP-PRO/PB III, as activation depends on the timing of the communication readouts and internal monitoring.

■ **Setting Up the Global Vibration Function**

The Global Vibration Function setting procedure is described below.

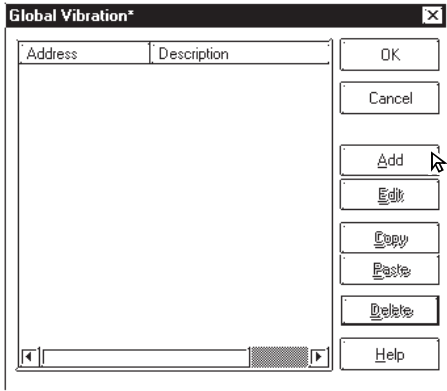
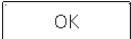
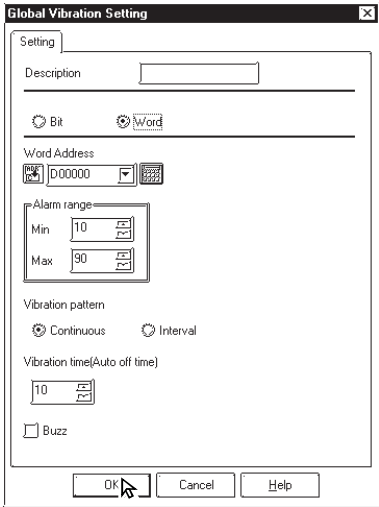
PROCEDURE	REMARKS
<p>(1) In the Screen Editor, select [Global Vibration] from the [Special] menu.</p> <p>(2) Click the  button, and set up the Global Vibration function.</p>  <p>(3) [Setting up the Global Vibration with a Bit Address] Enter the required options, and click .</p> 	

PROCEDURE	REMARKS
-----------	---------

[Setting up the Global Vibration with a Word Address]
 Enter the required options, and click .

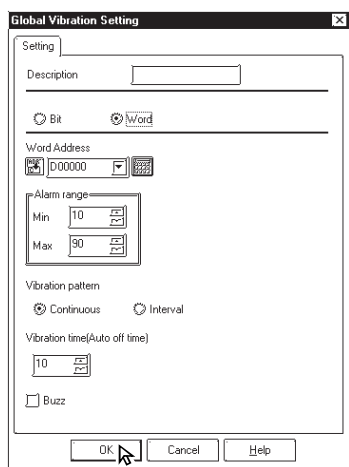

(4) Review the details of the settings in the Global Vibration window, and click to close the dialog box.

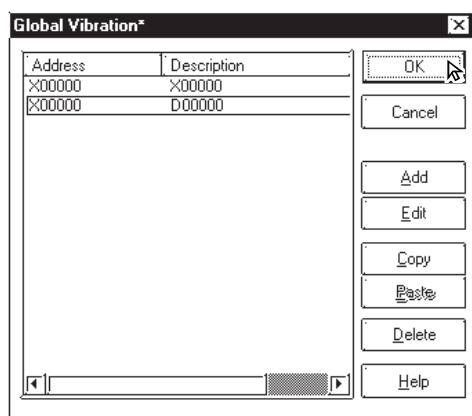

Clicking the button displays the following dialog box.

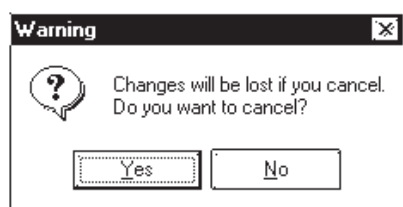

Click to close the [Global Vibration] dialog box without saving the changes you have made.

Click to return to the [Global Vibration] dialog box.

Click to complete the setup operation.

Up to sixteen Global Vibratio settings can be set up within a single Project.

When two or more trigger conditions for the Global Vibration settings are satisfied at one time, vibrations are executed in the sequence registered in the Global Vibration settings. However, note that internal conditions may prevent the vibrations from being generated in the specified sequence.

2.10 DXF Conversion

This feature allows you to convert DXF (Drawing Interchange File) file data into Base screen data, and to convert Base screen data into DXF file data. (A DXF file is on Auto Cad® drawing file)



DXF filenames must be alphanumeric.

DXF can be used for the Release 12 program. If a newer version's data is used, that data will not be converted.

When each object's coordinates are converted, errors may occur, thereby slightly changing them.

Once a DXF file data is converted into Base screen data, even if the Base screen is again converted back into the original DXF file, or vice-versa, the resulting data may be unusable.

When converting data, be sure that the screen's width and height ratio will be the same for both the Base screen and the DXF file (Screen size settings: \$LIMMAX, \$LIMMIN). If this ratio is different, after data is converted, object locations or shapes will also be different from the original.

2.10.1 Conversion from DXF File to Base Screen (DXF → PRW)

DXF file data is converted into Base screen data.

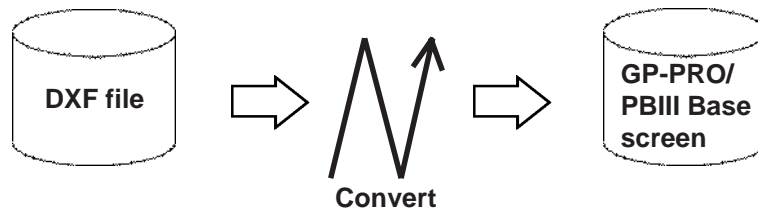

■ Requirements and Restrictions when Converting Data (DXF → PRW)

- Grouped objects (Blocks) can be nested up to 10 layers (levels deep).
- The DXF file data format is ASCII. Both “CR LF” and “LF” can be used as line feed characters and will be converted correctly.
- During conversion, when the resulting output file's size reaches 16Kbytes, the conversion will quit, and subsequent data will not be converted.
- Three dimensional data cannot be converted.
- If the X,Y coordinate screen boundaries (\$LIMMIN, \$LIMMAX) are not set up correctly in the DXF file, after the data created in the DXF file is converted into Base screen data, it may go beyond the Base screen's display area.

- After DXF file data is converted into Base screen data, the DXF file name is used as the Base screen's description.
- When a layer's attribute has been turned OFF, that layer's data will not be converted, and only ON layer data will be converted into Base screen data.
- Fill and Oval/Arc data cannot be converted.

■ Option (DXF → PRW)

Here, select and enter the color and size used when converting data. According to the specified DXF and Base screen size, data will be relatively magnified or minimized when converted.

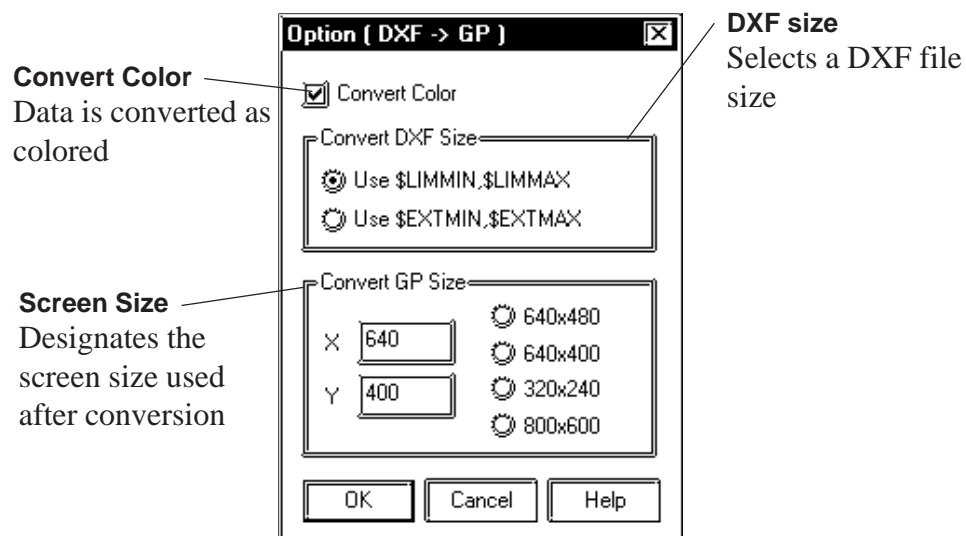

◆ Convert Color

When this box is checked, DXF file data is converted as colored. When this box is not checked, DXF file data is converted as monochrome.

Reference 2.10.1 ■ Color Conversion (DXF → PRW)

◆ Convert DXF Size

The DXF file data conversion range is selected.

When “Use \$LIMMIN, \$LIMMAX” is selected, data in the DXF file's maximum screen area (X,Y coordinate screen boundaries) will be converted. When “Use \$EXTMIN, \$EXTMAX” is selected, only data in the DXF file's object area will be converted.

◆ Convert GP Size

The Project File screen size (GP screen size) used after conversion is specified.

■ Color Conversion (DXF → PRW)

When the [Option] dialog box's [Convert Color Data] check box is checked, the DXF file's color data will be converted as follows:

DXF File Color No.	Base Screen
1 (red), 1X (red-based)	Red
2 (yellow), 5X (yellow-based)	Yellow
3 (green), 9X (green-based)	Green
4 (light blue), 13X (light blue-based)	Light blue
5 (blue), 17X (blue-based)	Blue
6 (purple), 21X (purple-based)	Purple
7 (white)	White
Other colors	White

The background color will be converted into Black.

■ Line Type Conversion (DXF → PRW)

Each DXF file's line type will be converted as follows:

DXF File	Base Screen
CONTINUOUS	——— Solid line
DASHED	- - - - Broken line
HIDDEN	- - - - Broken line
CENTER	- · - A dot-dash-line
PHANTOM	- · · - Two dot-dash-line
Other	——— Solid line

The user defined line types will be converted into solid lines.

■ Object Conversion (DXF → PRW)

The DXF file's objects will be converted as follows.

Colors and line types will be converted as shown above. Tiling patterns will be converted into solid Fill.

DXF File	Base Screen
LINE	Straight line
POINT (dot)	Straight line (The start and end are the same point)
CIRCLE	Regular circle
ARC	Arc
TRACE (thick line)	Filled polygon
SOLID (filled object)	Filled polygon
TEXT (characters and signs)	Text
DIMENSION (dimension indicator)	Straight line
INSERT (inserting object)	Conversion breaks down complex objects into component parts (objects)
ATTRIB (attribute)	Conversion breaks down complex objects into component parts (objects)
POLYLINE (polyline/donut-shaped/oval/polygon/rectangle)	Continuous straight line
VERTEX	Vertex coordinates of a continuous straight line

Objects other than the above will not be converted.

Each object's elements, other than colors and line types, will be converted as follows:

- ◆ **POINT (dot)**
 - A dot's pattern will be converted into "0" (point), and its display size will be converted into "0,0".
 - A dot will be converted to a straight line, with the start and end coordinates at the same point.
- ◆ **TEXT (characters and signs)**
 - A rotation angle will be converted into an angle closer to 90°, 180°, 270°, or 360°. (in 90° units)
 - The character size will be converted into a size closer to either 1, 2, 4, or 8 x magnification.
 - Special characters that will be converted are %%d (°), %%c (φ), and %%p (±).
 - When text contains more than 100 characters, it will be divided every 100 characters into records of data and then converted.
 - When more than 100 character text is divided into records of data, groups of overflowing characters after the first 100 characters will be dislocated toward the right bottom for a few dots.
 - Tilting angles, character fonts, and character spacing will not be converted.
 - Text will be converted based on the ASCII code; therefore, the character style (Standard, Bigfont, etc.) or font file settings will be ignored.
 - When text with half-sized and full-sized characters mixed in vertical lines is converted, the half-sized characters will be centered.
- ◆ **DIMENSION (Dimension Indicator)**
 - During conversion, the breaking down of a grouped object (Block) is performed by referring to the Block's sections, which indicate the Block's component parts (objects). However, dots will not be converted.
- ◆ **INSERT (Inserting Object)**
 - A grouped object defined in the Block section will be broken down into each drawing object and converted.
 - Up to 10 layers of nested data will be converted. However, since all the data will be converted into a single layer on a single screen, the objects over the limit (file capacity) will not be converted.
 - Although the rotating angles, and the number of lines and columns can be converted (lines and columns of the objects over the limit will not be converted), their ratio (scaling) will not be converted.
 - The grouped object created in Layer "0" will be converted based on the inserted layer's colors and line types, however, a grouped object created in an other layer level will not be converted based on the inserted layer's colors and line types. In this case, if BYBLOCK is specified to the grouped object, the inserted layer's colors and line types will be used.
 - Simulated object sectioning (hatching) data cannot be converted, since, when the Block section's hatching data pattern is converted into each drawing object, that data size can exceed the GP file capacity.
 - If another file's grouped object has been inserted or another file is referred, that grouped object will not be converted.
- ◆ **ATTRIB (attribute)**

ATTRIB (attribute) data is part of INSERT data.

 - Attribute data will be converted in the same manner as TEXT conversion.



◆ **POLYLINE (polyline/donut-shaped/oval/polygon/rectangle)**

- POLYLINE data will be converted connecting the following VERTEX's coordinates with a continuous straight line. Only data whose polyline flag is either "0 (default)", "1 (closed polyline)", "2 (adding the fit curve vertex)", or "4 (adding the spline curve vertex)" will be converted.
- When the number of vertices exceeds 100, data will be divided every 100 vertices and converted.
- When the converted data's coordinates are repeated at the same point, the following coordinates will be omitted.
- When a polyline has curved sections, they will not be converted. Therefore, donut-shaped lines and curved polylines will be converted into continuous straight lines, connecting each coordinate point.

◆ **VERTEX**

- Top coordinates of a polyline.
- A polyline's width will not be converted.

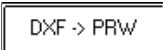
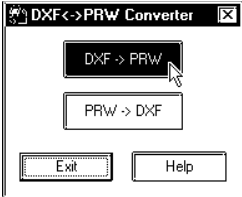
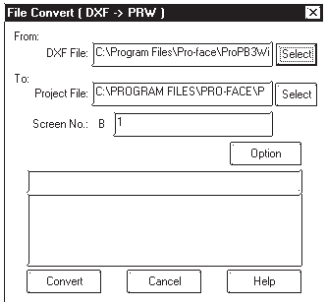
■ **Converting DXF File Data to Base Screen Data**

PROCEDURE	REMARKS
<p>(1) Select the pull down menu [Utility]'s [Convert DXF] command.</p> <p>(2) Click on the  button.</p>  <p>(3) Designate the source (DXF file) and the destination (Project File), and enter the Base screen number.</p> 	<p>To designate a folder, click on the  button.</p>

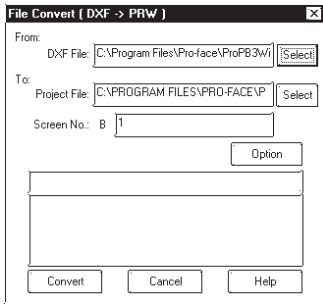
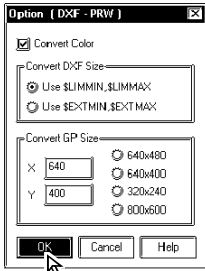
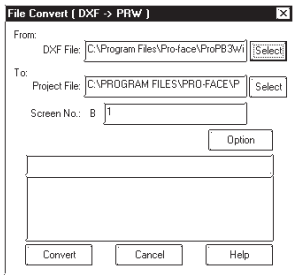
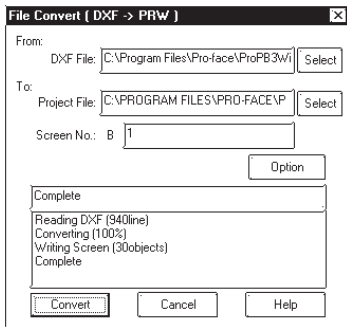
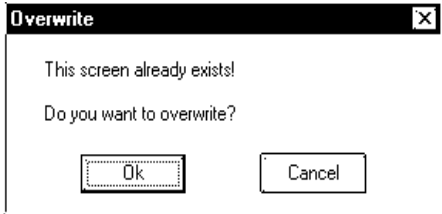
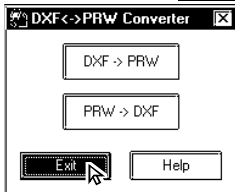
PROCEDURE	REMARKS
<p>(4) Click on the Option button and enter the conversion conditions.</p> 	
<p>(5) After all the attributes have been entered, click on the OK button to registered the entered data.</p> 	<p>Reference 2.10.1 ■ Option (DXF → PRW)</p>
<p>(6) Click on the Convert button to start conversion.</p> 	<p>If the designated screen number already exists, a prompt will appear, asking whether the new number should overwrite the old number. When the OK button is clicked on, the new number will overwrite the old one, and when the Cancel button is clicked on, the new number will not overwrite the old one.</p>
<p>(7) After the conversion is completed, click on the Cancel button. The [DXF<->PRW Converter] dialog box will reappear.</p> 	
<p>(8) Click on the Exit button to quit.</p> 	<p>To convert another DXF file, DO NOT cancel here; rather, start from step (3) again.</p>

2.10.2 Conversion from Base Screen to DXF File (PRW → DXF)

Base screen data is converted into DXF file (Drawing Interchange File) data.

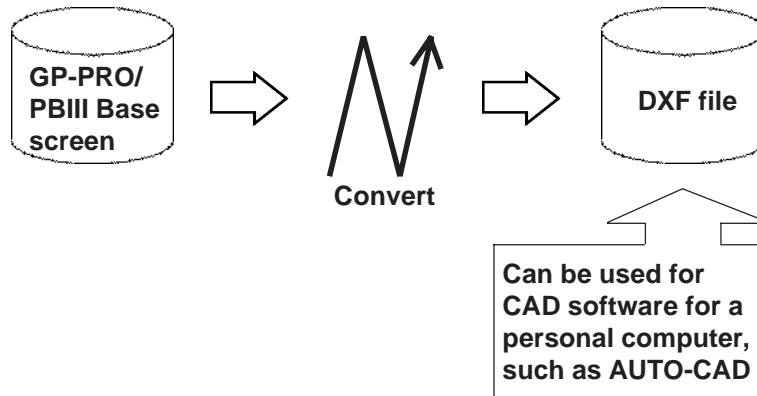

■ Requirements and Restrictions when Converting Data (PRW → DXF)

- Only Base screens can be converted.
- Image screens called up on the Base screen will not be converted.
- Tag data will not be converted, so for example, M-tag's Marks will not be displayed after conversion.
- When text is converted, the character size and position may differ from the original due to font type difference and errors created during conversion.
- Since Load Mark will be converted into a simple straight line (i.e. no width), if it has been magnified, it will be displayed differently from the original after it is converted.



If you try to convert a filled polygon that has four peaks, one of which introverts, into a DXF file, this polygon will not be converted properly.

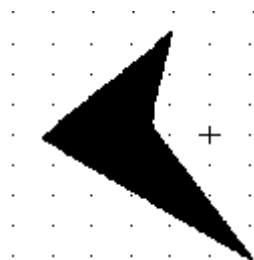

■ Option (PRW → DXF)

Here, select and enter color and size data used when performing data conversion.

Screen Size

Designates the GP screen size after conversion

DXF size

Designates the DXF screen size when Base screen data is converted into DXF file data

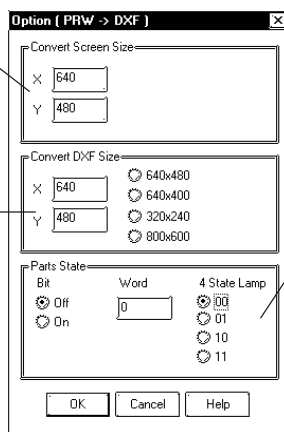

Parts State

Selects and enters the Part State when converted

◆ Convert Screen Size

The screen size of a GP unit specified in the Project File.

◆ Convert DXF Size

The DXF file size used after data is converted using data conversion is selected. The default values are the same as the Screen Size values mentioned above.

◆ Parts State

Bit When Part display states (ON/OFF) are specified, that Part will be converted for each display state.

Word .. Picture Display and Message Display will be converted with the display state specified here.

■ Color Conversion (PRW → DXF)

Base screen's drawing data colors will be converted as follows:

Base Screen	DXF File Color No.
Black	250 (gray)
Blue	5 (blue)
Green	3 (green)
Light blue	4 (light blue)
Red	1 (red)
Purple	6 (purple)
Yellow	2 (yellow)
White	7 (white)











The blink settings will not be converted.

With a 64 color GP unit, colors on the color palette will be converted as follows:

Black	Blue	Black	Black	Blue	Blue	Green	Green
Light blue	Light blue	Green	Light blue	Black	Black	Blue	Blue
Black	Black	Blue	Blue	Green	Green	Light blue	Light blue
Green	Green	Light blue	Light blue	Red	Red	Purple	Purple
Red	Red	Purple	Purple	Yellow	Yellow	White	White
Yellow	Yellow	White	White	Red	Purple	Red	Red
Purple	Purple	Yellow	Yellow	White	White	Yellow	White

■ Line Type Conversion (PRW → DXF)

Base screen's line types will be converted as follows:

Base Screen	DXF File
 1-dot solid line	CONTINUOUS
 1-dot broken line	DASHED
 1-dot one-dot-dash line	CENTER
 1-dot two-dot-dash line	PHANTOM
 2-dot solid line	CONTINUOUS
 2-dot broken line	DASHED
 2-dot one-dot-dash line	CENTER
 2-dot two-dot-dash line	PHANTOM
 3-dot solid line	CONTINUOUS
 5-dot solid line	CONTINUOUS

The line thickness will be converted in the same thickness for all the lines, regardless of the line types.

■ Object Conversion (PRW → DXF)

Base screen's drawing data will be converted as follows.

Colors and line types will be converted as shown in the previous page's table. The background colors will not be converted. Tiling patterns will be converted into solid Fill.

Base Screen	DXF File
Straight line/Continuous straight line	LINE/POLYLINE
Square/Filled Square	POLYLINE/SOLID
Regular Circle/Filled Regular Circle	CIRCLE/CIRCLE + SOLID
Oval/Filled Oval	POLYLINE/POLYLINE + SOLID
Arc/Pie	ARC/ARC + POLYLINE
Division	Collection of lines
Filled Polygon	SOLID or POLYLINE
Load Screen	Broken down into each Part object and converted
Text	TEXT
Load Mark	POLYLINE
Part	Broken down into each part and converted

Data other than the above will not be converted.

◆ Straight line/Continuous straight line



- When the number of coordinates is "2", a straight line or continuous straight line will be converted into LINE. If this number is other than 2, it will be converted into POLYLINE.
- When a line has an arrow at one end, a solid filled triangle will be drawn at the end coordinates, and when a line has arrows at both ends, solid filled triangles will be drawn at both ends.

◆ Square/Filled Square

- Any line will be converted into POLYLINE.
- Any Fill will be converted into SOLID.

- ◆ **Regular Circle/Filled Regular Circle**
 - Filled regular circle's border will be converted into CIRCLE and its filling will be converted into SOLID.
- ◆ **Oval/Filled Oval**
 - Any lines will be converted into POLYLINE.
 - Filled oval's border will be converted into CIRCLE and its filling will be converted into SOLID.
- ◆ **Arc/Pie**
 - Pie's straight line section will be converted into POLYLINE.
- ◆ **Divisions**
 - When the divisions are marked on a straight axis, their coordinates will be calculated based on their start and end coordinates, direction, and the number of divisions, and will be converted into LINE.
 - When the divisions are marked on an arc axis, their coordinates will be calculated based on their start and end angles, external circle's radius, internal circle's radius, number of divisions, and will be converted into LINE.
- ◆ **Filled Polygon**
 - Fill will be converted into SOLID. However, if the number of vertices is more than 5, Fill will not be converted and only its trace will be converted into POLYLINE (CONTINUOUS).
- ◆ **Load Screen**
 - The screen will be retrieved from its attributes, and screen number and if it exists, and each drawing data will be converted.
 - The called up screen's data will be converted in the same layer as other drawing data.
 - Only Base, Keypad, and Trend Graph screens will be converted.
- ◆ **TEXT**
 - Characters written horizontally will be converted into BIGFONT. Those written vertically will be converted into TATEGAKI (vertical type of BIGFONT).
 - 1/4-sized characters will be all converted into half-sized characters.
 - Half-sized (1/4-sized) characters written horizontally will be converted with a relative scale of 1/2 in the X direction, and other size characters will be converted with a relative scale of 1.
 - Both half and full-sized characters written vertically will be converted with a scale of 1 for their height and width. Therefore, the half-sized characters will become the same size as the full-sized characters.
 - Character types of "Bold" and "Raised" will not be converted.
 - Due to font difference and other elements, text will be different from the Base screen, after conversion.
- ◆ **Load Mark**
 - The Mark screen will be retrieved from the screen number, if that screen exists, the dot pattern will be converted into POLYLINE (CONTINUOUS).
- ◆ **Part**
 - Each Part's data will be converted into drawing data.

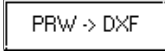
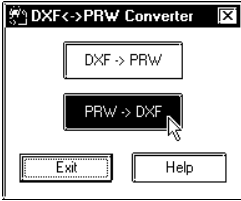
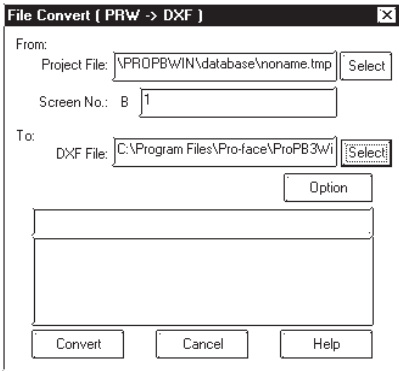
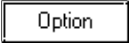
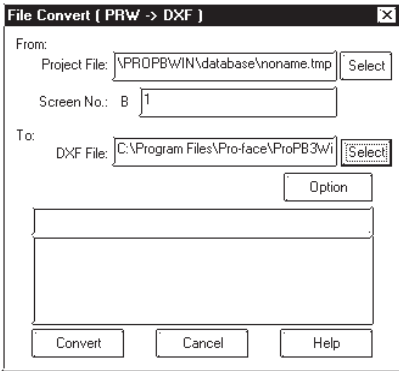
■ Converting Base Screen Data to DXF File Data

PROCEDURE	REMARKS
<p>(1) Select the pull down menu [Utility]'s [DXF Conversion] command.</p> <p>(2) Click on the  button.</p>  <p>(3) Designate the source (Project File) and Base screen number and designate the destination (DXF file).</p>  <p>(4) Click on the  button and enter the conversion conditions.</p> 	<p>To designate a folder, click on the  button.</p>

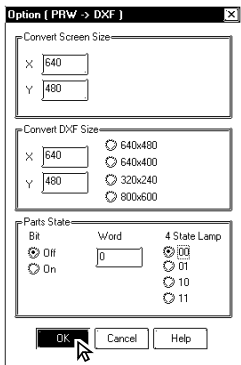
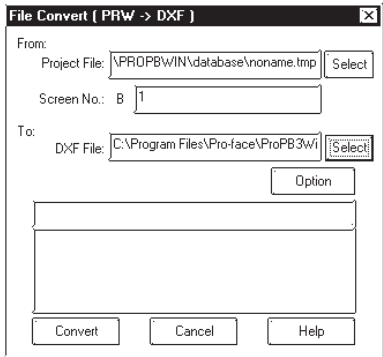
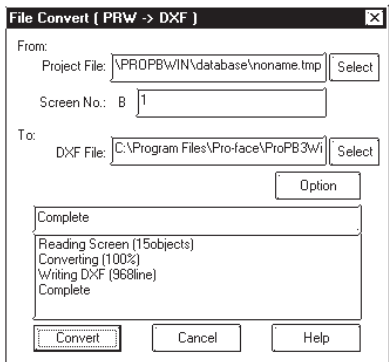
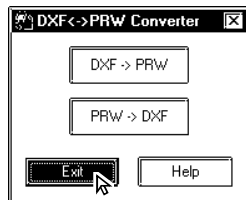
PROCEDURE	REMARKS
<p>(5) After all the attributes have been entered, click on the <input type="button" value="OK"/> button to registered the entered data.</p> 	<p>Reference 2.10.2 ■ Option (PRW → DXF)</p> <p>If the designated DXF file name already exists, a prompt will appear, asking whether the new name should overwrite the old name. When the <input type="button" value="OK"/> button is clicked on, the new name will overwrite the old one, and when the <input type="button" value="Cancel"/> button is clicked on, the new name will not overwrite the old one.</p> <p>To convert another Base screen, DO NOT stop here; rather, start again from step (3).</p>
<p>(6) Click on the <input type="button" value="Convert"/> button to start conversion.</p> 	
<p>(7) After the conversion is completed, click on the <input type="button" value="Cancel"/> button. The File Convert (GP → DXF) dialog box will reappear.</p> 	
<p>(8) Click on the <input type="button" value="Exit"/> button to quit.</p> 	

Memo

GP-PRO/PB III for Windows provides various screens for specific purposes (for example: for creating marks and messages), in addition to the Base screens which are the fundamental screen used for all drawing modes. Other screens can then be loaded onto Base screens as libraries. Also, you can load them directly onto the GP series panel using specified tags.

This chapter describes the procedure for creating these screens and their applications.

- 3.1 **Creating a Mark: the Mark Screen**
- 3.2 ... **Creating a Trend Graph: the Trend Graph Screen**
- 3.3 **Creating a Keypad: the Keypad Screen**
- 3.4 **Text Input: the Text Screen**
- 3.5 **Creating an Image: the Image Screen**
- 3.6..... **Video Data Display (V Screen)**
- 3.7..... **Window Display: Window (U) Screen
and Base (B) Screen**

3.1 Creating a Mark: the Mark Screen

Create a mark (dot pattern) on a “Mark” screen. Using the [Draw] menu - [Load Mark] command, you can load the created mark onto a Base screen, “Tend Graph” screen or “Keyboard” screen. Also, you can animate the created Mark screen by specifying the M-tag.

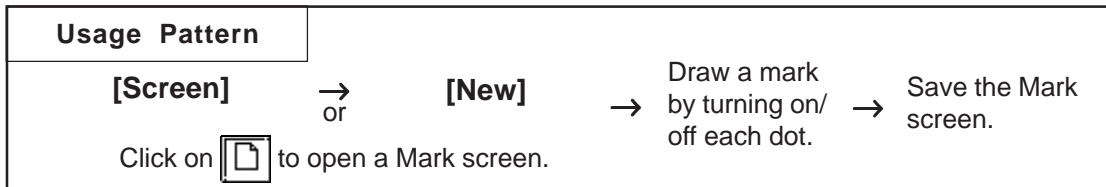



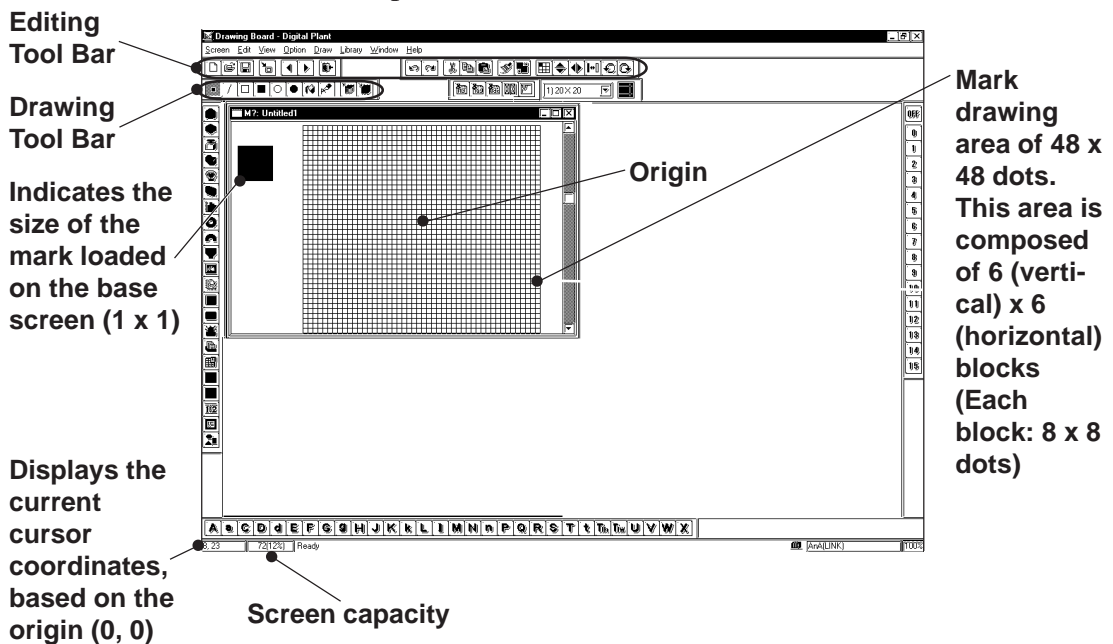







General description of the Mark screen:



■ Drawing Tools













The Drawing Tool Bar icons and their corresponding drawing objects are as follows:

Icon	Drawing Tool	Description
	Dot	Specify the ON/OFF status of each dot by clicking on each dot or dragging the mouse within a specified area.
	Line	Specify the start and end points of a line and draw a line by clicking on desired points.
	Square (Rectangle)	Draw a square or rectangle by clicking and dragging to the desired size on a diagonal axis.
	Filled square (Filled rectangle)	
	Circle/Oval	Draw a circle or oval by clicking and dragging to the desired size on a diagonal axis.
	Filled circle (Filled oval)	

Icon	Drawing Tool	Description
	Fill	Fill in an area with a desired color by clicking in the area (enclosed within lines and shapes).
	Text	Enter the text to be displayed in the mark drawing area.
	Call Up Mark Library	Select a Mark from the Mark Library
	Register Mark Library	Register a created Mark as a Mark Library.

■ Editing Tools

The Editing Tool Bar icons and their corresponding functions are as follows:

Icon	Editing Tool	Description
	Cut	Used to delete an entire Mark screen and store it in the clipboard*1. Using the [Paste] command, you can then paste the Mark screen onto another screen.
	Copy	Used to copy the data of the selected Mark screen in the clipboard.
	Paste	Used to paste the data temporarily stored in the clipboard onto a desired place.
	Duplicate	Used to duplicate a Mark screen's specified area.
	Delete	Used to delete a mark.
	Undo	Used to cancel the command executed immediately before, and return to the previous condition. (Undo)
	Redo	Used to redo the command canceled with the [Undo] command. (Redo)
	Mirror X	Used to move the dot pattern symmetrically relative to the vertical axis. The symmetry axis is the vertical line that divides the screen into two equal sections.
	Mirror Y	Used to move the dot pattern symmetrically relative to the horizontal axis. The symmetry axis is the horizontal line that divides the screen into two equal sections.
	Turn counterclockwise	Used to turn the mark counterclockwise by 90°.
	Turn clockwise	Used to turn the mark clockwise 90°.
	Reverse	Used to reverse the white/black area of a mark.
	Transparent/Background color	If no dots are turned ON in a block (8 x 8 dots), this block becomes transparent.

*1 When the [Copy] or [Cut] command is used, the copied or cut data is temporarily stored in the clipboard.

When you use the [Paste] command, the data stored in the clipboard are pasted to the selected position.

■ Mark Drawing Area Structure

The mark drawing area has the following structure. When you edit a mark, you can use this for your reference.

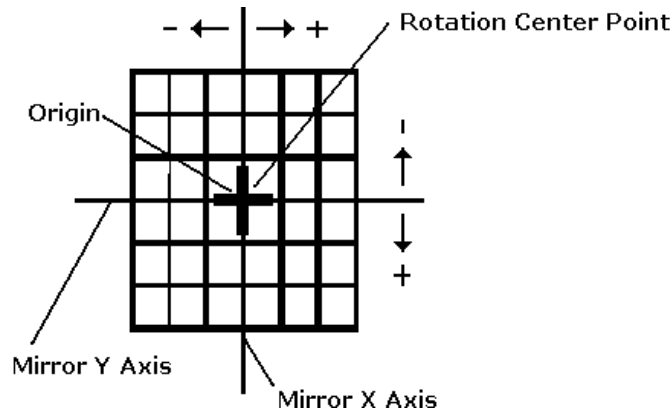

3.1.1 Drawing a Mark

When drawing a mark you can use GP-PRO/PBIII for Windows' standard drawing functions. Here, the procedures for using each function are described.

■ Drawing with Dots

You can draw a mark by turning ON/OFF each dot. When you click the left mouse button in the mark drawing area, each dot turns ON (white). When you click the right mouse button in the mark drawing area, each dot turns OFF (black).

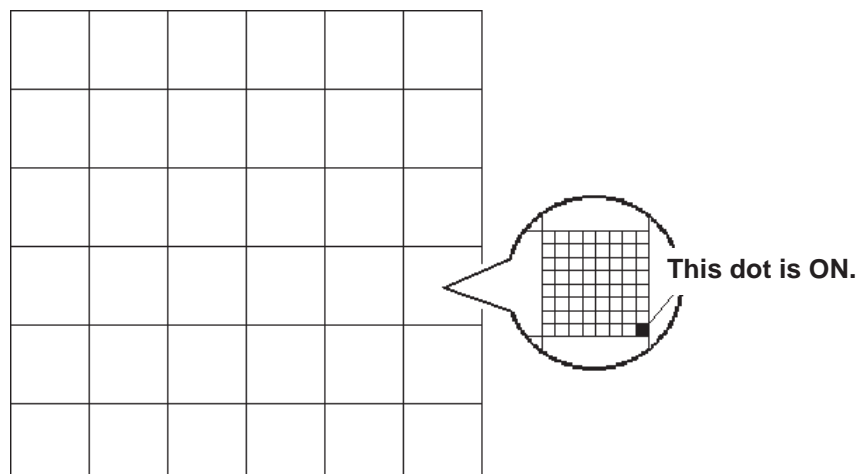

A mark is created with dots, and displayed in a block (8 x 8 dots). If at least one dot is turned ON in a block, the whole block is displayed when the Mark screen is loaded onto a Base screen. In this status, the ON dots are displayed in the current display color (Fg), and the OFF dots are displayed in the background color (Bg).



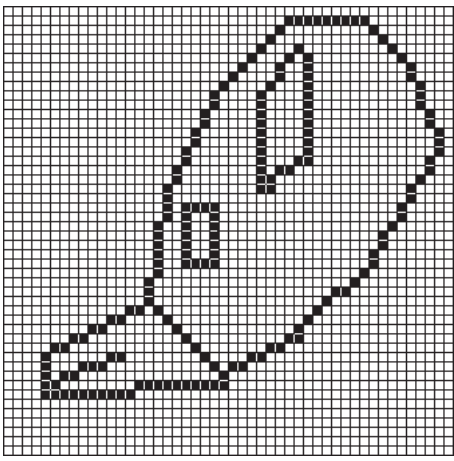

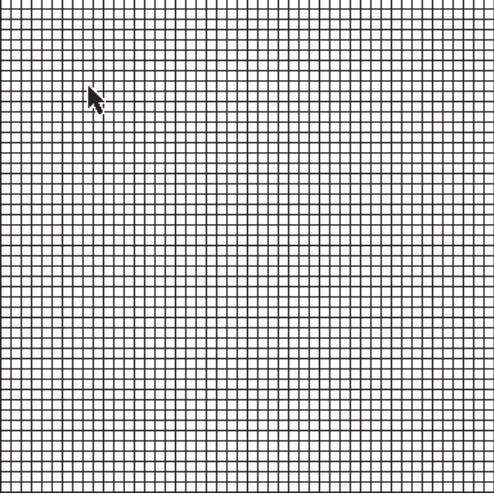
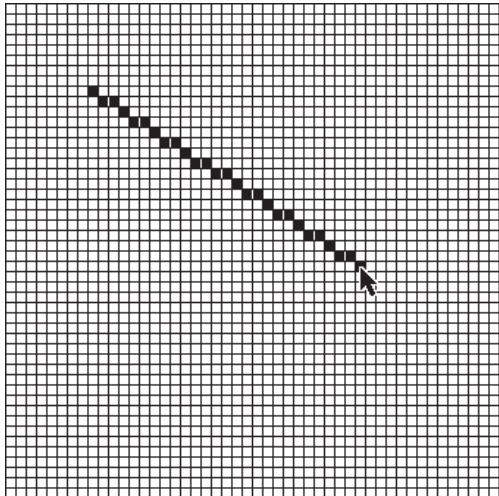

■ Freehand Drawing

PROCEDURE	REMARKS
<p>(1) Select the [Draw] menu - [Dot] command, or click on the  icon.</p> <p>(2) Draw a mark by clicking on each dot or by dragging the mouse in the mark drawing area.</p> 	



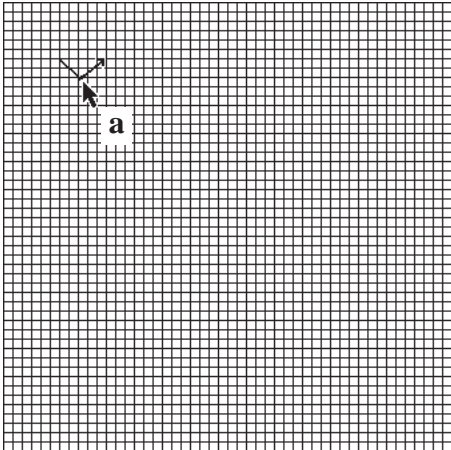
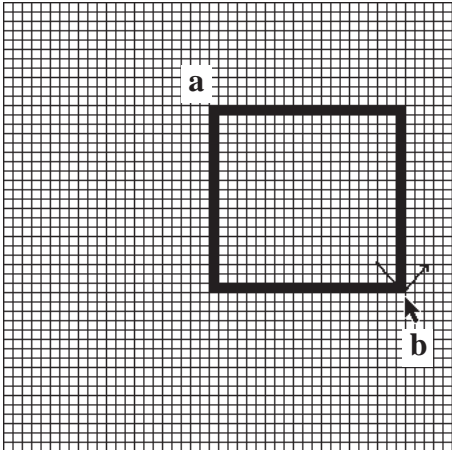

■ Drawing a Line

PROCEDURE	REMARKS
<p>(1) Select the [Draw] menu - [Line] command, or click on the  icon.</p> <p>(2) Click on a start point in the mark drawing area and drag the mouse.</p>  <p>(3) Click the end point in the mark drawing area. A line is defined.</p> 	<p>If you press and hold the  key in step (2), you can draw a line at an angle of 0°, 45°, and 90°.</p>

■ Drawing a Square (Rectangle) or Filled Square (Filled Rectangle)

PROCEDURE	REMARKS
<p>(1) Select the [Draw] menu - [Square/Rectangle] or [Filled Square/Rectangle] command, or click on the  or  icon.</p> <p>(2) Click on a point (a) and drag the mouse on a diagonal axis in the mark drawing area.</p> 	
<p>(3) Click on the end point (b). A square or rectangle is defined.</p> 	<p>If you press and hold the  key in step (2), you can draw a square.</p>

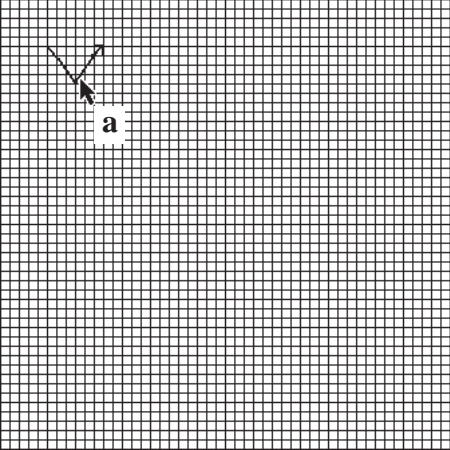
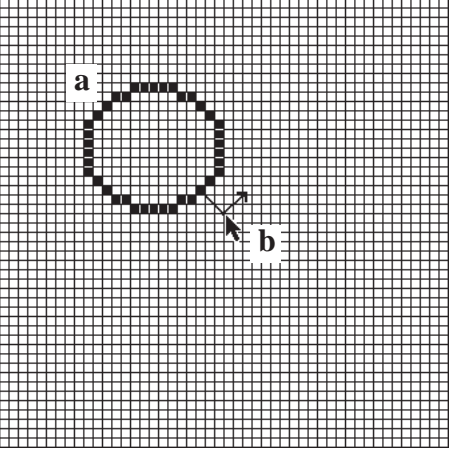
■ Drawing Circle (Oval) or Filled Circle (Filled Oval)



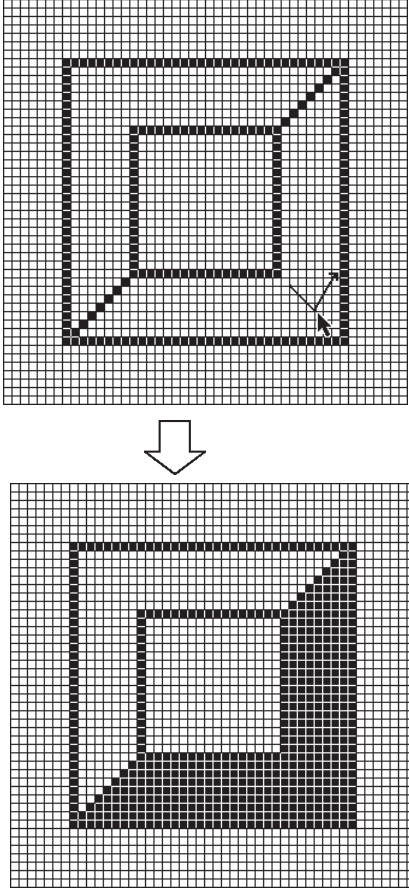

PROCEDURE	REMARKS
<p>(1) Select the [Draw] menu - [Circle/Oval] or [Filled Circle/Filled Oval] command, or click on the  or  icon.</p> <p>(2) Click on a point (a) and drag the mouse on a diagonal axis in the mark drawing area.</p>  <p>(3) Click on the end point (b). A circle or oval is defined.</p> 	<p>If you press and hold the  key in step (2), you can draw a circle.</p>

■ Filling a Mark

PROCEDURE	REMARKS
<p>(1) Select the [Draw] menu - [Fill] command, or click on the  icon.</p> <p>(2) Click inside the area to be filled. The specified area will be filled.</p> 	<p>If you click on a line, the filling mode cannot be executed. Be sure to click inside a completely enclosed area, if you do not, the entire mark screen may be filled.</p>

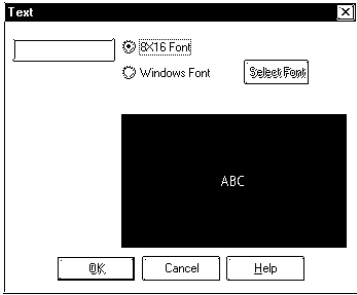
■ **Entering Text**

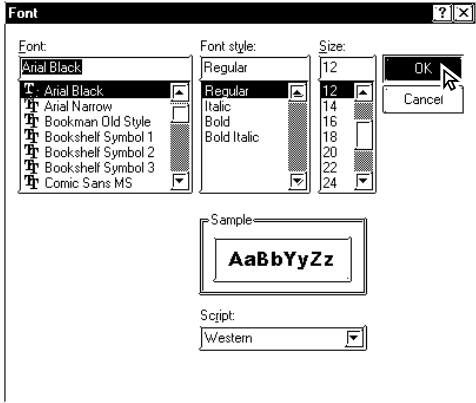
The “Text” mode allows you to enter text on a Mark screen.

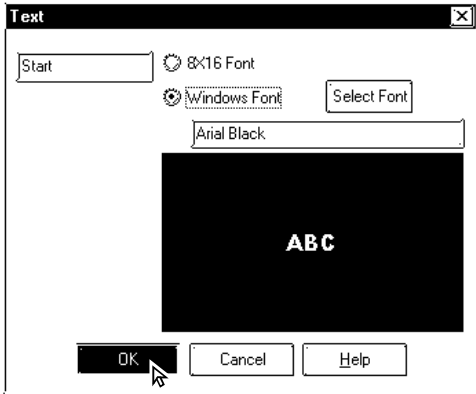
PROCEDURE	REMARKS
<p>(1) Select the [Draw] menu - [Text] command, or click on the  icon.</p> <p>(2) Enter character(s) and select either 8 x 16 dot font or Windows font.</p>  <p>(3) To use the Windows font, click on the  and click on the  button.</p>  <p>(4) Click on the  button.</p> <p>An outline corresponding to the entered character(s) will appear.</p> 	

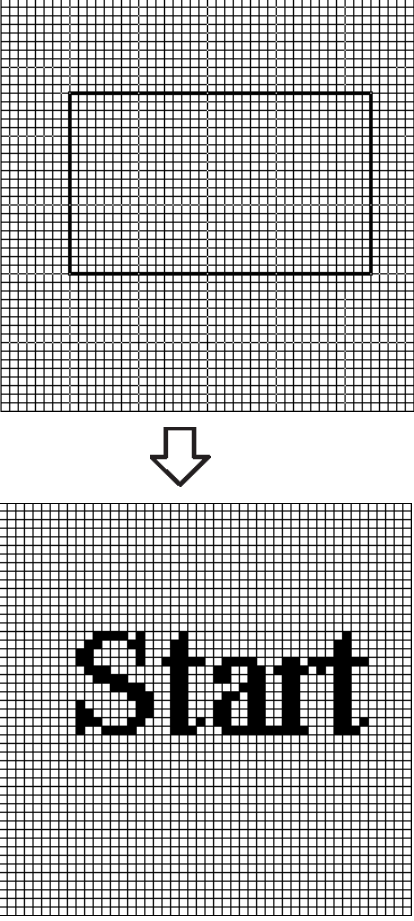
PROCEDURE	REMARKS
<p>(5) Move the box to the desired position where the character pattern will be displayed. The character pattern is displayed in the position where you click. A Mark can be created using this pattern.</p> 	<p>If you move the character pattern to a position where another character pattern has already been created, the new pattern will overwrite the existing pattern, and the existing pattern will be deleted.</p>

3.1.2 Special Mark Characters

■ Creating Special Characters on a Mark screen

When the European character set has been selected, you can register (create) any kind of the special character you wish. These special characters are handled by Mark screens M8001 to M8128, so up to 128 special characters can be created. The data (characters) on these "special" screens are can then be inserted into any text string, using special reference codes. For example, to call up Mark screen M8001's special character, we need to input the corresponding reference code 80h, and to call up screen M8002, we would enter 81h, etc. However, since these codes are in Hex format, and in GP-PRO/PBIII 's text input mode we can only enter decimal data, we need to use the Hex code's decimal equivalent, shown on the table on page 138.

When any kind of character is "registered" on Mark screens M8001 to M8128, the GP will interpret it as a "special" character. Thus, when the GP encounters one of the abovementioned special reference codes, it automatically searches for the corresponding Mark file. If the file exists (i.e. has been registered and sent to the GP), it replaces its default GP character with the special character Mark.

This feature is useful when you need to change the GP's default character font addresses to match those used by your PC's OS.



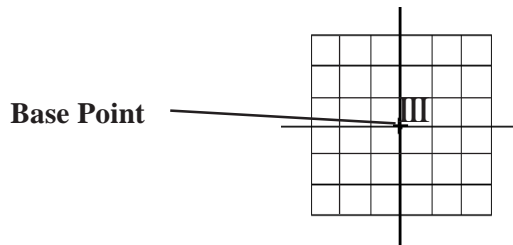

- **The number of special characters that can be used is limited to the number of Mark tags available, i.e 128.**
- **When creating a special character Mark screen, start from point 0,0 (Base point) and use only two 8x8 dot squares.**



■ Displaying (Calling up) a Special Character

The method for displaying a registered special character is as follows.

PROCEDURE	REMARKS
<p>The character "III" , previously registered in Mark screen M8010, will be displayed on the GP.</p> <p>(1) Open the Base screen where you want to display the special character, and click on the  icon.</p> 	

PROCEDURE	REMARKS
<p>(2) Hold down the [Alt] key and use your PC's numeric keypad inputting the ASCII code that corresponds to the desired Mark screen. The (ASCII) character code that corresponds to screen M8010 is 89h, however here, since the code entered must be decimal, enter the corresponding Input code, 235. This should cause the character "e" to appear. (One application of this special character could be to place it after the text "GP-PRO/PB". In that case, simply enter "GP-PRO/PB" followed immediately by the Input code)</p> <p>(3) After placing this text on the Base screen, saving the screen, and then sending the data (i.e. the Base screen and the Mark file) to the GP, instead of the "ë" character, the Mark screen's "III" will appear.</p>	<div style="text-align: center;">  </div> <p>The character displayed, since it is only for reference, will be different from the desired "III". After the Base screen and the Mark file are sent to the GP, the correct character will be automatically displayed.</p>



Characters used by the GP may sometimes differ from those used by GP-PRO/PB III for Windows. Please be sure to check all characters after they are sent to the GP.

If the corresponding Mark file is not sent with the Base screen to the GP, the GP will substitute one of its regular characters. (0x80 to 0xFF)

Special characters can not be rotated.

■ Character (Reference) Codes

The GP displays characters from the chart shown here. (Code Page 850 character codes)

	0	1	2	3	4	5	6	7	8	9	a	b	c	d	e	f
0	■	■	■	■	■	■	■	■	■	■	■	■	■	■	■	■
1	■	■	■	■	■	■	■	■	■	■	■	■	■	■	■	■
2	!	"	#	\$	%	&	'	()	*	+	,	-	.	/	
3	0	1	2	3	4	5	6	7	8	9	:	;	<	=	>	?
4	@	A	B	C	D	E	F	G	H	I	J	K	L	M	N	O
5	P	Q	R	S	T	U	V	W	X	Y	Z	[\]	^	_
6	`	a	b	c	d	e	f	g	h	i	j	k	l	m	n	o
7	p	q	r	s	t	u	v	w	x	y	z	{		}	~	■
8	Ç	ü	é	â	ä	à	å	ç	ê	ë	ï	î	í	ä	Å	■
9	È	Ë	Ê	Ë	È	Í	Î	Ï	Ï	Û	Ü	Ù	Ú	Û	Ü	■
a	á	í	ó	ú	ñ	Ñ	±	°	¿	¼	½	¾	¡	«	»	■
b	■	■	■	■	■	■	■	■	■	■	■	■	■	■	■	■
c																
d																
e																
f	-	±	=	¼	½	¾										

89h = ë

■ Hex/Decimal Corresponding Character Codes

When inputting reference codes for special Mark screens, use the chart below.



Mark Screen	Char Code Code Page 850	Input Code (ALT+code)	Char Code Code Page 850	Input Code (ALT+code)	Char Code Code Page 850	Input Code (ALT+code)
M8001	80h	0199	B0h	0130	E0h	0211
M8002	81h	0252	B1h	0131	E1h	0223
M8003	82h	0233	B2h	0132	E2h	0212
M8004	83h	0226	B3h	0133	E3h	0210
M8005	84h	0228	B4h	0134	E4h	0245
M8006	85h	0224	B5h	0193	E5h	0213
M8007	86h	0229	B6h	0194	E6h	0181
M8008	87h	0231	B7h	0192	E7h	0254
M8009	88h	0234	B8h	0169	E8h	0222
M8010	89h	0235	B9h	0135	E9h	0218
•	8Ah	0232	BAh	0136	EAh	0219
•	8Bh	0239	BBh	0137	EBh	0217
•	8Ch	0238	BCh	0138	ECh	0253
•	8Dh	0236	BDh	0162	EDh	0221
	8Eh	0196	BEh	0165	EEh	0175
	8Fh	0197	BFh	0139	EFh	0180
	90h	0201	C0h	0140	F0h	0173
	91h	0230	C1h	0141	F1h	0177
	92h	0198	C2h	0142	F2h	0159
	93h	0244	C3h	0143	F3h	0190
	94h	0246	C4h	0144	F4h	0182
	95h	0242	C5h	0145	F5h	0167
	96h	0251	C6h	0227	F6h	0215
	97h	0249	C7h	0195	F7h	0184
	98h	0255	C8h	0146	F8h	0176
	99h	0214	C9h	0147	F9h	0168
	9Ah	0220	CAh	0148	FAh	0183
	9Bh	0248	CBh	0149	FBh	0185
	9Ch	0163	CCh	0150	FCh	0179
	9Dh	0216	CDh	0151	FDh	0178
	9Eh	0128	CEh	0152	FEh	0247
	9Fh	0129	CFh	0164	FFh	0160
	A0h	0225	D0h	0240		
	A1h	0237	D1h	0208		
	A2h	0243	D2h	0202		
	A3h	0250	D3h	0203		
	A4h	0241	D4h	0200		
	A5h	0209	D5h	0153		
	A6h	0170	D6h	0205		
	A7h	0186	D7h	0206		
	A8h	0191	D8h	0207		
	A9h	0174	D9h	0154		
	AAh	0172	DAh	0155		
	ABh	0189	DBh	0156		
	ACH	0188	DCh	0157		
	ADh	0161	DDh	0166		
	Aeh	0171	DEh	0204		
	Afh	0187	DFh	0158		

3.1.3 Editing a Mark

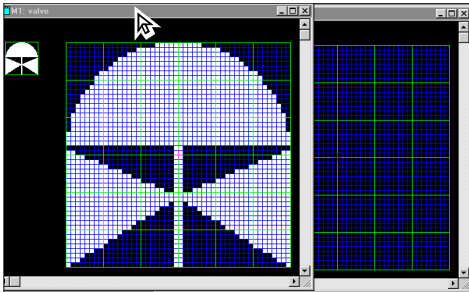

To edit a mark, you can use the following editing functions. This section describes the operating procedure for each function.

■ **Cutting a Mark**

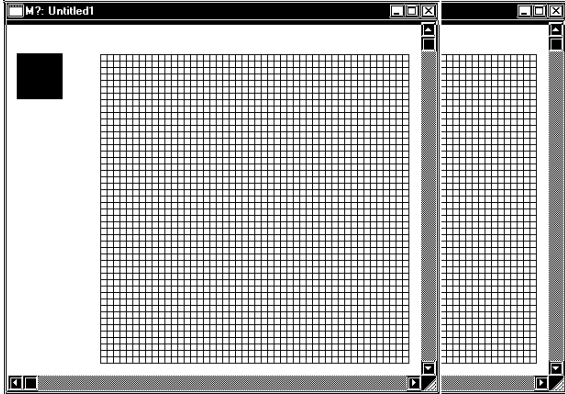
The “Cut” command deletes the data of the selected screen and stores it in the clipboard*1. (The deleted screen can be moved to another screen, but cannot be moved to the original screen.) The “Cut” command can be executed for the entire screen.

PROCEDURE	REMARKS
<p>(1) Select the original Mark screen to be cut. This description assumes that several screens have already been opened.</p>  <p>(2) Select the [Edit] menu - [Cut] command, or click on the  icon to store the Mark data in the Clipboard. Data of the original data screen will be cut.</p> 	<p>To delete the Mark screen, perform steps (1) and (2) only.</p>

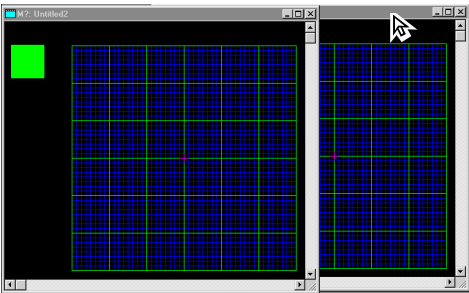
*1 When the [Copy] or [Cut] command is executed, the copied or cut data are temporarily stored in the clipboard.
 When you execute the [Paste] command, the data stored in the clipboard will be pasted to the selected position.

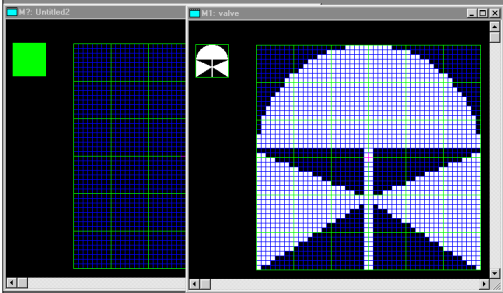



PROCEDURE	REMARKS
<p>(3) Select the mark screen (destination) to which the selected Mark screen will be pasted.</p>  <p>(4) Select the [Edit] menu - [Paste] command, or click on the  icon. Data of the Mark screen will be pasted.</p> 	

■ Copying a Screen

The selected screen data are copied in the clipboard. Unlike the [Cut] command, the original screen data will not be deleted.

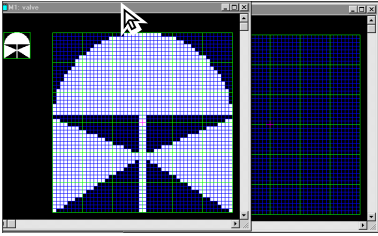

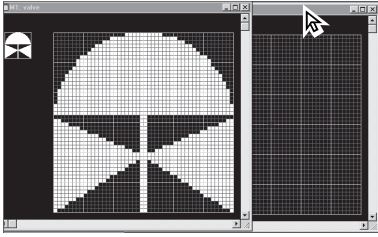

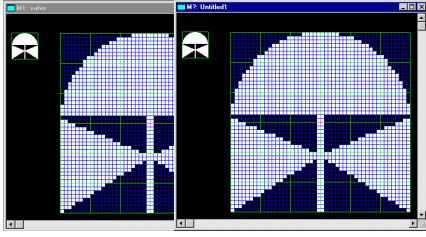
To copy a mark into the original screen, use the [Duplicate] command.

PROCEDURE	REMARKS
<p>(1) Select the original Mark screen to be copied. This description assumes that several screens have already been opened.</p>  <p>(2) Select the [Edit] menu - [Copy] command, or click on the  icon to store the mark in the Clipboard.</p> <p>(3) Select the mark screen (destination) to which the selected Mark screen will be copied.</p>  <p>(4) Select the [Edit] menu - [Paste] command, or click on the  icon. Data will be copied from the original Mark screen and pasted onto the destination Mark screen.</p> 	

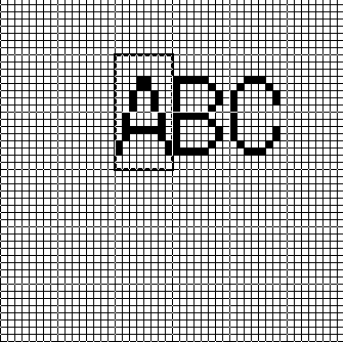
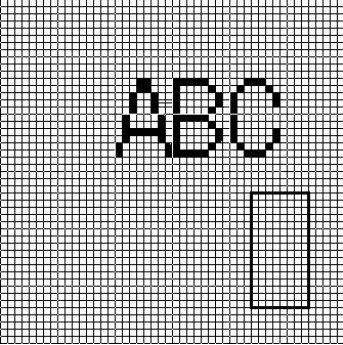

■ Copying a Specified Range : Duplication

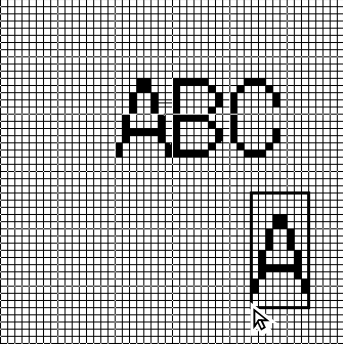
A specified range in the mark drawing area can be duplicated by dots.

PROCEDURE	REMARKS
<p>(1) Select the [Edit] menu - [Duplicate] command, or click on the  icon.</p> <p>(2) Specify the copy range in the same manner as drawing a square/rectangle. A box appears, indicating the specified copy range.</p> 	
<p>(3) Move the box to a desired position where the data in the specified range will be copied. Data in the specified range will be copied to the position where you click.</p> 	<p> Important <i>If you copy a mark into the position where another mark has already been created, the new data will overwrite the existing data, and the existing data will be deleted.</i></p> <p>You can continue the copy mode until you click the right mouse button.</p>
<p>(4) To quit the copy mode, click the right mouse button.</p> 	

■ **Deleting a Mark**

Delete the mark, a partion of it.

PROCEDURE	REMARKS
<p>(1) Select the [Edit] menu - [Delete] command, or click on the  icon.</p> <p>The procedures for deleting part of a mark or deleting a whole mark are separately described:</p> <p>[Deleting Part of a Mark]</p> <p>(2) Select [Partial Clear] and click on the  button.</p> <div data-bbox="263 734 651 987" data-label="Image"> </div> <p>(3) Specify the range to be deleted in the same manner as drawing a square/rectangle.</p> <div data-bbox="263 1128 716 1579" data-label="Image"> </div>	

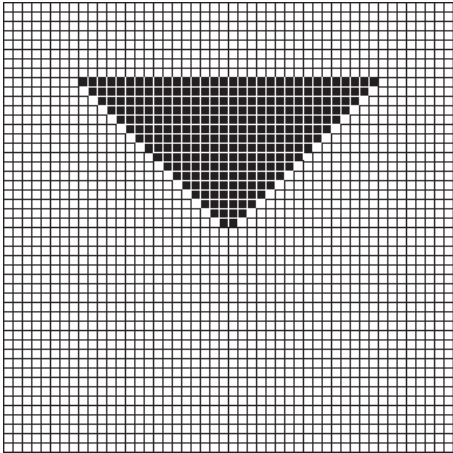
PROCEDURE	REMARKS
<p>(4) Click in the range to be deleted. The specified range will be deleted.</p> 	

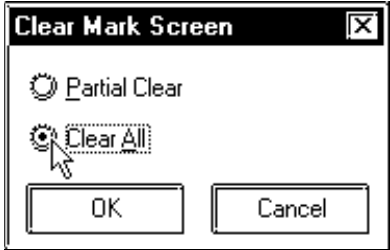
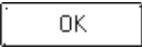
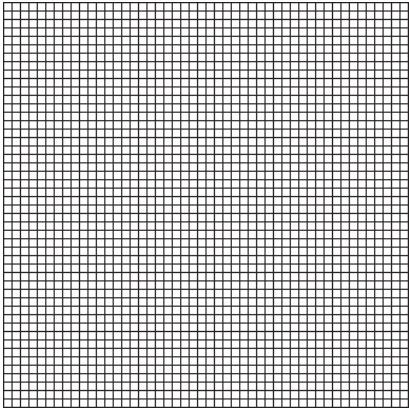
PROCEDURE	REMARKS
<p>[Deleting the Entire Mark]</p> <p>(2) Select [Clear All].</p>  <p>(3) Click on the  button to delete the entire mark. The entire mark will be deleted.</p> 	

■ **Mirror X, Mirror Y**

The “Mirror X” and “Mirror Y” functions move a mark symmetrically relative to the vertical and horizontal axis, respectively.

To execute the “Mirror X” and “Mirror Y” functions, click on the   icon, respectively.

Example) Mirror X

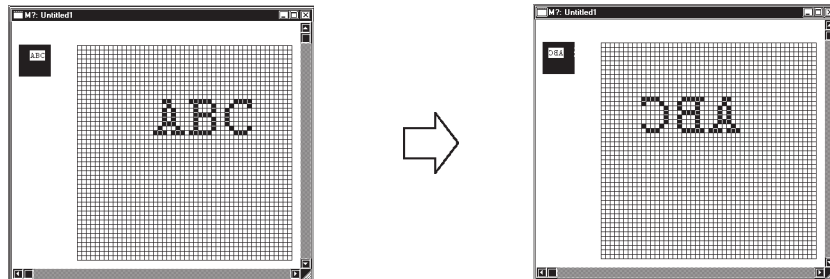

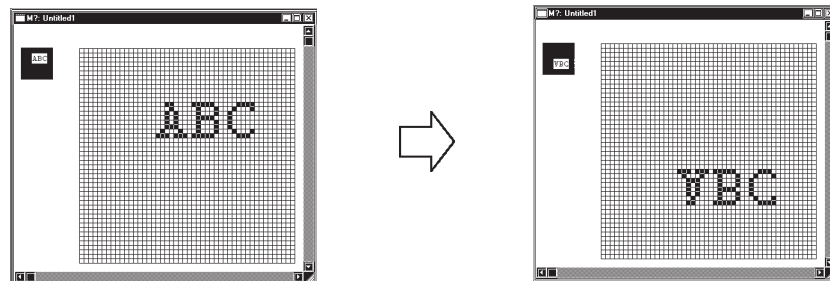

Example) Mirror Y



■ **Turn Counterclockwise [O], Turn Clockwise [N]**

The “Turn Counterclockwise”, “Turn Clockwise” functions turn the mark counterclockwise and clockwise 90°, respectively.

To execute the “Turn Counterclockwise” and “Turn Clockwise” functions, click on their respective the   icons respectively.

Example) Turn Counterclockwise

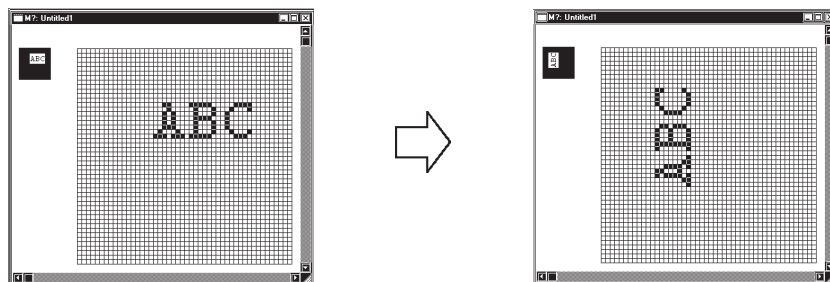

Example) Turn Clockwise

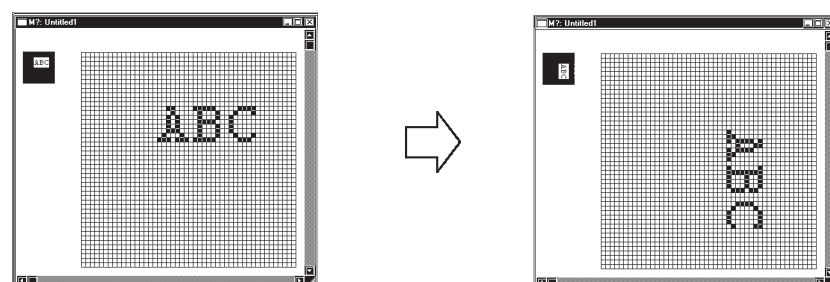

■ Reverse

This function reverses the white and black areas. In the reverse display mode, all ON dots are turned OFF, and all OFF-dots are turned ON.

To execute this function, click on the  icon.

Example)

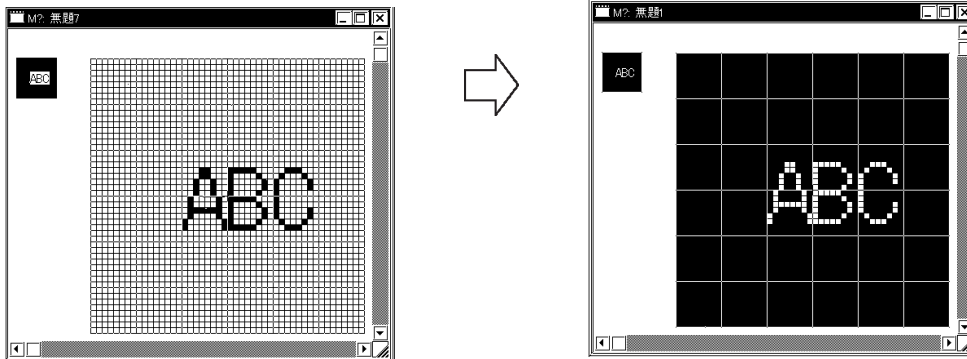

■ Transparent/Background Color

If no dots are turned ON in a block, this block becomes transparent. When this function is set to “Background color”, a block without any ON dots is displayed in the background color (Bg).

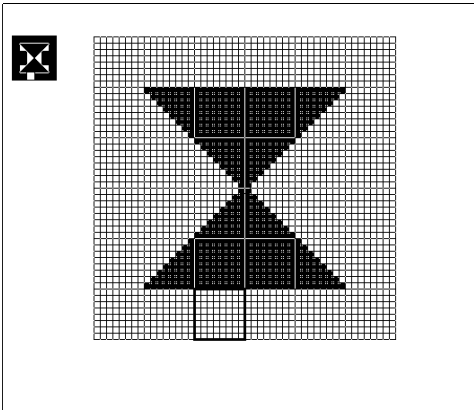
PROCEDURE	REMARKS
<p>(1) Select the [Edit] menu - [Background Color] command, or click on the  icon.</p> <p>(2) Click in the block to be displayed in the background color. The border line of the specified block is changed. Every time you click in the block, the color setting is switched.</p> <div style="border: 1px solid black; padding: 10px; margin: 10px 0;">  </div> <p>(3) Click the right mouse button to register the above setting.</p>	

■ Display When Called Up to a B (Base) Screen

When this function is set to “Transparent”:

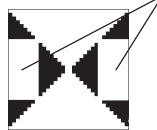
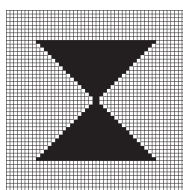

These blocks contain no ON-dots.

If at least one dot is ON in a block, this block is displayed in the background color.

The block with no ON dots becomes transparent, and you can see the objects on the base screen.

When this function is set to “Background color”:

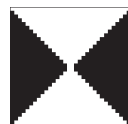
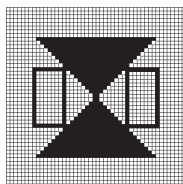

The block with no ON dots is displayed in the background color.

■ Canceling a Command: Undo

This function is used to cancel a command and return to the previous condition immediately before the command was made.

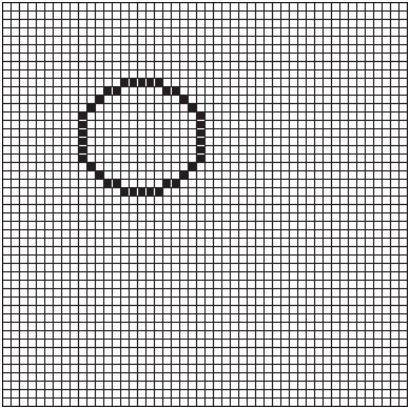

[Undo] is only effective for the command immediately before it.

PROCEDURE	REMARKS
<p>After deleting a circle unintentionally:</p> <p>(1) Select the  icon.</p> <p>The deleted circle is restored, and the screen returns to the previous condition.</p> 	

■ Redo Command

This function is used to redo the command canceled with the [Undo] command.

The [Redo] command is effective only for the command immediately before it.

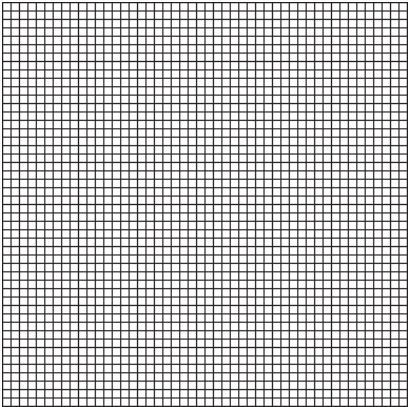
PROCEDURE	REMARKS
<p>After deleting a circle, you have selected the  icon to return to the previous condition, but you realize that actually, the circle must be deleted:</p> <p>(1) Select the  icon.</p> <p>The screen returns to the condition where the circle has been deleted and harmony is restored.</p> 	

3.1.4 Registering and Placing a Mark Library Item

You can register a mark created in the mark drawing area and the registered mark can be loaded whenever required. The Mark Library Item (mark list) can be saved as a mark library file (MRK file). The GP-PRO/PB III enables you to manage MRK files independent of project (PRW) files. This function allows you to use the same mark for several projects, since you can select a desired mark while checking the image displayed in the browser. Registration, placement, and other editing operations of Mark Library are performed in the same manners as those of the standard Libraries.

▼ **Reference** ▲ *2.5 Libraries*



Note: GP-PRO/PB III for Windows has pre-made MRK files in correspondence with the ISO7000 Series marks and symbols.

▼ **Reference** ▲ *Parts List Manual*

Drawing symbol number	MRK file name	Title
0001-0200	IS07-1	0001-0200
0201-0400	IS07-2	0201-0400
0401-0600	IS07-3	0401-0600
0601-0800	IS07-4	0601-0800
0801-1000	IS07-5	0801-1000
1001-1140	IS07-6	1001-1140



3.2 Creating a Trend Graph: the Trend Graph Screen

You can create a trend graph with the Trend Graph screen. Using the [Draw] menu - [Load Screen] command, you can load a trend graph from the Trend Graph screen onto a Base screen. The specified loading point is placed at the center of the screen. Up to eight Trend Graph screens can be loaded onto one Base screen.

Usage Pattern	
Open a Trend Graph screen by selecting the [Screen] menu [New] command, or by clicking on the icon.	Draw the graph axis and scales by using the drawing tool.
Set the screen by selecting the [Tag] menu - [Set Screen] command, or by clicking on the icon.	Set the channel by selecting the [Tag] menu - [Set Channel] command, or by clicking on the icon.
Save the Trend Graph screen.	Save the Trend Graph screen.
Open a Base screen [Draw] →	[Draw] → [Load Screen] or Click on to call up a Trend Graph.
→	→ The selected Trend Graph screen will be displayed on the Base screen.

■ Creating a Trend Graph

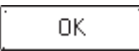
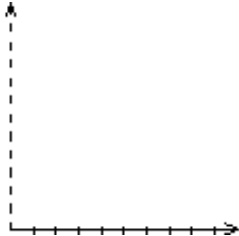
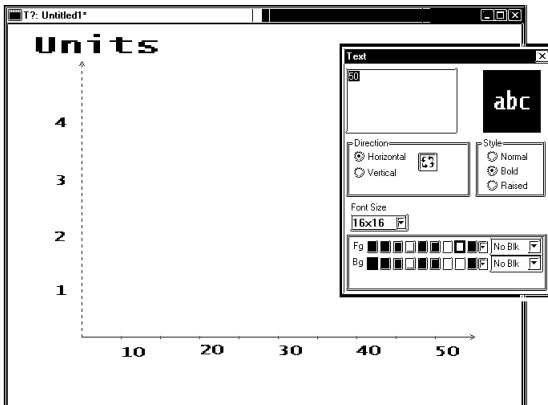
PROCEDURE	REMARKS
<p>(1) Select the [Screen] menu - [New] command, or click on the icon.</p> <p>(2) Select a Trend Graph screen.</p> <div style="border: 1px solid black; padding: 5px; width: fit-content; margin: 5px 0;"> </div> <p>(3) Select the [Tag] menu - [Set Screen] command, or click on the icon.</p> <p>(4) Set the parameters for the [Screen Settings] screen.</p> <div style="border: 1px solid black; padding: 5px; width: fit-content; margin: 5px 0;"> </div>	<p style="text-align: center;">▼ Reference ▼ 1.1.3 Opening/Closing/Saving a Screen</p> <p>The effective setting range of the “pitch”, “Number of display data” and “Scroll” parameters for the [Set Screen] command varies depending on the setting values. Be sure to set these parameters.</p> <p style="text-align: center;">▼ Reference ▼ Tag Reference Manual, 2.31 Trend Graph Display/, Setting Origin, 100% of height and pitch.</p>

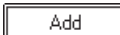
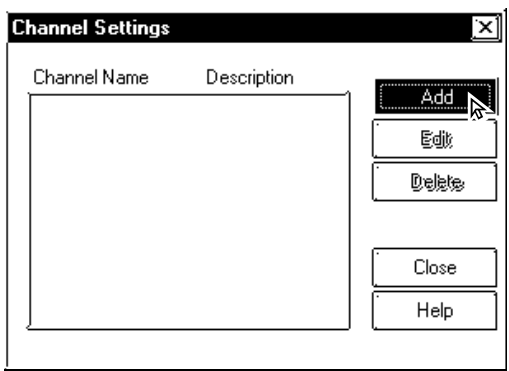
PROCEDURE	REMARKS
<p>(5) After setting all items, click on the  button to register the above settings.</p> <p>The graph display area is displayed with handles in the drawing area. Change the size and position of the graph display area, as required.</p> 	<p>Reference 2.4 Object Editing</p>
<p>(6) Draw the graph axis and scales.</p> 	<p>Reference 2.2 Drawing</p> <p>Reference 2.4 Object Editing</p> <p>Draw the graph axis and scales outside the graph display area so that they will not overlap with the graph display area. If the graph axis and scales are placed in the graph display area, they cannot be displayed when the Trend Graph screen is operated on the GP series' panel.</p>
<p>(7) Select the [Tag] menu - [Set Channel] command, or click on the  icon.</p>	<p>You can execute the same operation by selecting the [Tag] menu - [Set Channel] command, instead of clicking on the  icon.</p>
<p>(8) Click on the  button in the [Channel Settings] dialog box.</p> 	

PROCEDURE

REMARKS

(9) Designate [Channel Settings]' each item.

Each function of the trend graph display is called “Channel” instead of “Tag”.

To specify a channel name, you can use up to five characters (including alphanumeric and symbols.)

To specify a channel’s description, you can use up to twenty characters.

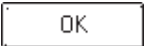
(10) After setting all items, click on the  button to register the settings.

To display several trend graphs in the same graph display area, repeat the above procedure from step (7).

Up to twenty trend graphs (including tags and parts) can be displayed for one project.

Reference *Tag Reference Manual, 2.31 Trend Graph Display*

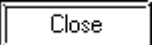
(11) Click on the  button to close the [Channel Settings] dialog box.

(12) After setting all items, save the Trend Graph screen.

Reference *1.1.3 Saving a Screen*

(13) Open a Base screen. Then, select the [Draw] menu - [Load Screen] command, or click on the  icon to call up a Trend Graph screen.



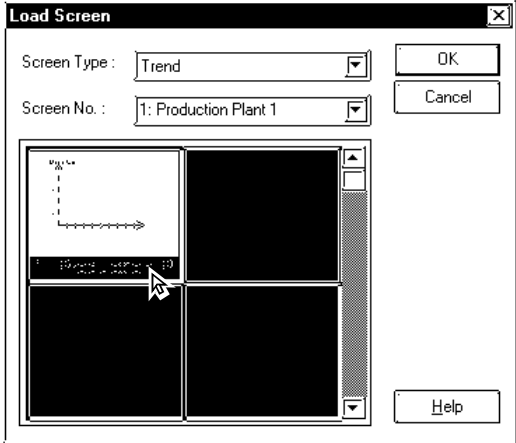
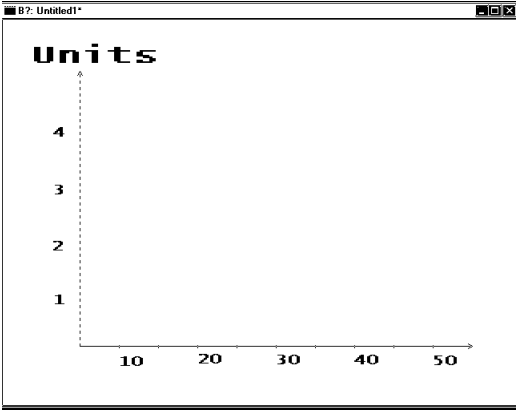

Reference *2.2.10 Load Screens*

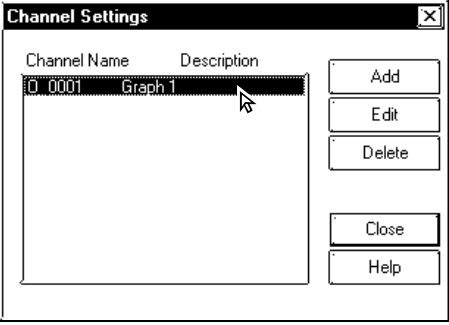
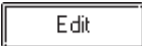
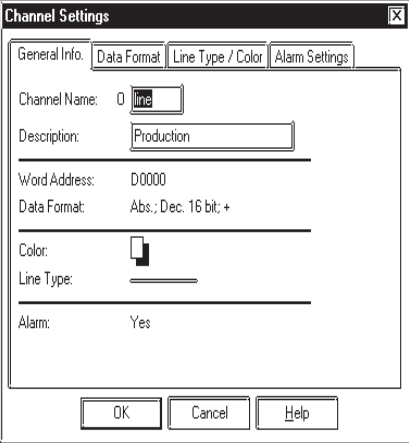
PROCEDURE	REMARKS
<p>(14) Select a screen you want to call up from the list, and then click on the <input type="button" value="OK"/> button.</p>  <p>(15) The selected screen will be placed in the position you have clicked on.</p> 	

■ Editing a Channel

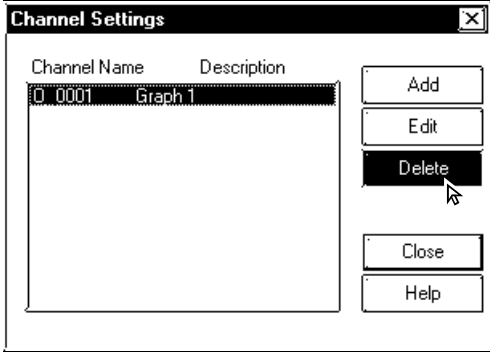
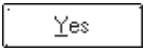
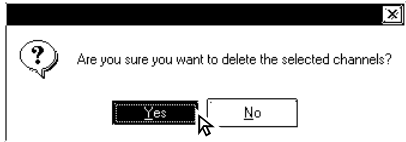
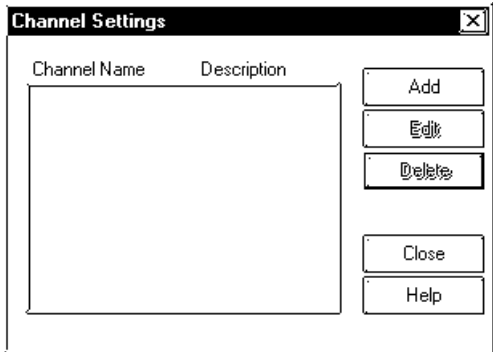
PROCEDURE	REMARKS
<p>(1) Select the channel to be edited.</p>  <p>(2) Click on the  button.</p> <p>The setting item dialog box will be opened, enabling you to edit the channel.</p> 	<p>To select several channels, click on the channel names while pressing the Shift key.</p> <p>To select an individual channel, click on the channel name while pressing the Ctrl key.</p>

■ Deleting a channel

PROCEDURE	REMARKS
<p>(1) Select a channel you wish to delete and click on the  button.</p>  <p>(2) Click on the  button.</p>  <p style="text-align: center;">↓</p> 	<p>To select several channels, click on the channel names while pressing the  key.</p> <p>To select an individual channel, click on the channel name while pressing the  key.</p> <p> Important Once the [Delete] command is executed, the deleted channel cannot be re-stored.</p>

3.3 Creating a Keypad: the Keypad Screen

You can create a keyboard with the Keypad screen. Using the [Draw] menu - [Load Screen] command, you can load a keypad from the Keypad screen onto a Base screen. When the Keypad screen is loaded, the specified loading point is placed at the center of the screen.

▼ **Reference** ▲ *2.2.10 Load Screens*

The GP-PRO/PB III provides several sample keyboards. Using the sample keyboards, there is no need to create a keyboard on each screen.

▼ **Reference** ▲ *3.3 Creating a Keypad: the Keypad Screen, ■ Application of Sample Keyboards*

To use a keypad Part, place it on a Base screen directly.

▼ **Reference** ▲ *2.1.13 Keypad Display*

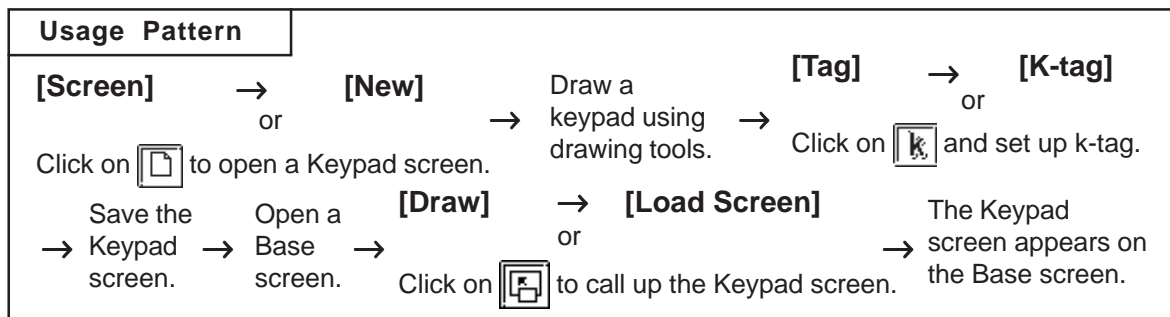

■ **Creating a Keypad**

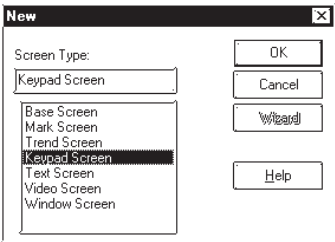
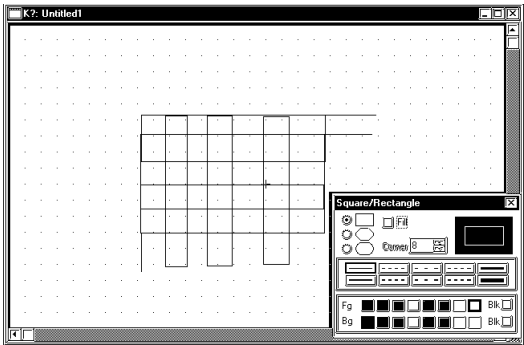
PROCEDURE	REMARKS
(1) Select the [Screen] menu - [New] command, or click on the  icon.	▼ Reference ▲ <i>1.1.3 Opening/ Closing/Saving a Screen</i>
(2) Open a Keypad screen.	
	▼ Reference ▲ <i>2.2 Drawing</i>
(3) Draw a keypad.	
	

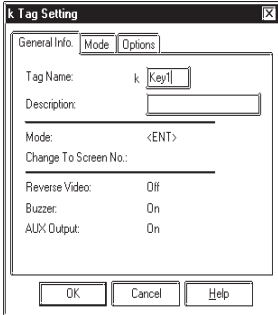
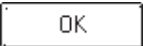
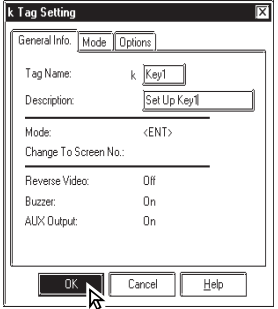
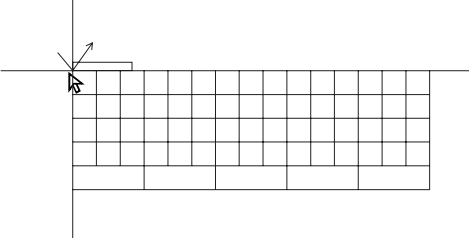
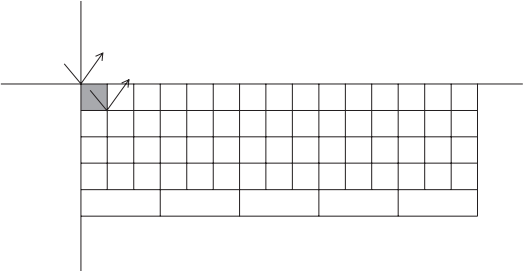
PROCEDURE	REMARKS
<p>(4) Select the [Tag] menu - [k-tag] command, or click on the  icon.</p> 	
<p>(5) Enter or designate k-tag's each setting item.</p>	
<p>(6) After setting all items, click on the  button to register the settings.</p> 	<p>To specify a tag name, you can use up to five characters (including alphanumerics, symbols and “Double-sized” characters.)</p> <p>Reference <i>Tag Reference Manual, 2.12 K-tag (Key Input)</i></p> <p>To specify a channel name, you can use up to twenty characters.</p>
<p>(7) Specify the tag name position by clicking on a desired point.</p> 	
<p>(8) Specify the touch area (where the specified tag will be activated) in the same manner as drawing a square/rectangle. Repeat steps (4) through (8) to set the k-tag for all keys.</p> 	<p>Specify the touch area so that it will not overlap with the touch area of another tag.</p>

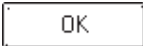
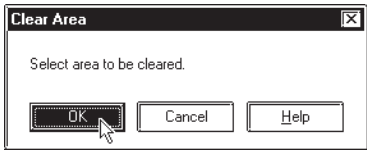
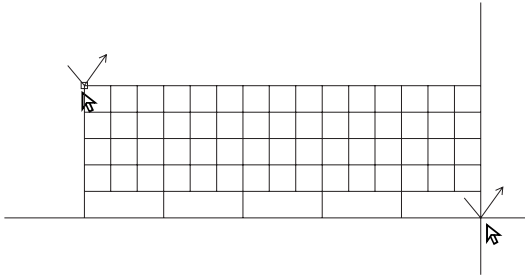
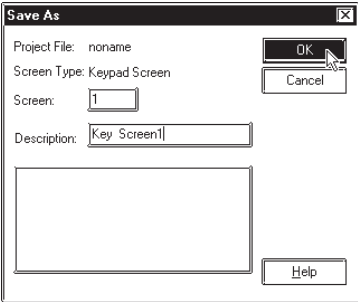
PROCEDURE	REMARKS
<p>The “screen switching function” of the k-tag enables you to replace the keypad display area with another keyboard screen.</p> <p>To use this function, set the [Clear Area].</p> <p>To replace the keyboard screen, start the procedure from step (9). Otherwise, start the procedure from step (12).</p> <p>(9) Select the [Tag] menu - [Clear Area] command, or click on the  icon.</p> <p>(10) Click on the  button.</p>  <p>(11) Specify the area to be cleared in the same manner as drawing a square/rectangle.</p> <p>Load the keypad to be replaced, and specify the display area. In this example, the entire keypad display area is specified.</p>  <p>(12) After completing the above settings, save the keypad screen.</p> 	<p style="text-align: center;">Reference <i>1.1.3 Opening/Closing/Saving a Screen</i></p>

■ Application of Sample Keypads

Several sample keypads (files created with the GP-PRO III) are provided in the “KEYLIB” folder below the folder (C:\PROPBWIN) where the GP-PRO/PB III has been installed. You can use the sample keypads, and also edit them to create a new keypad. To use the sample keypads, load the keypad screens (files created with the GP-PRO III) into the current project.



Note: Instead of the sample keypads, keypad Parts can also be used.

▼ Reference 2.1.13 Keypad Display

The following is the general procedure for using the sample keyboards:

- (1) Load a file of the memory link type (K8***.DLM) from “C:\PROPBWIN\KEYLIB” into the current project. Load the necessary keyboard screen from “C:\PROPBWIN\KEYLIB” into the current project.

▼ Reference 12.1.1 Conversion from GP-PRO II or GP-PRO III

- (2) Open a keypad screen and edit the screen, as required.

▼ Reference 1.1.3 ■ Opening a New Screen

The following sample keypads are provided:

File name	Keyboard shape and input mode
K8000.DLM	Ten-keypad, Decimal input
K8001.DLM	Ten-keypad, Hexadecimal input
K8002.DLM	Ten-keypad, Control keys, Horizontal
K8003.DLM	Full keys, Horizontal, Numbers
K8004.DLM	Full keys, Horizontal, Symbols
K8005.DLM	Full keys, Horizontal, Uppercase alphabet
K8006.DLM	Full keys, Horizontal, Lowercase alphabet
K8009.DLM	Full keys, Horizontal, Basic type
K8010.DLM	Ten-keypad, Control keys, Vertical
K8011.DLM	Full keys, Vertical, Numbers
K8012.DLM	Full keys, Vertical, Symbols
K8013.DLM	Full keys, Vertical, Uppercase alphabet
K8014.DLM	Full keys, Vertical, Lowercase alphabet
K8017.DLM	Full keys, Vertical, Basic type

Example) K8000

△	▽	←	→
7	8	9	DEL
4	5	6	-
1	2	3	E
0	.	CLR	N
			T

Ten-key pad,
Decimal input

Example) K8007

a	b	c	d	e	f	g	h	i	j	k	NUM	EU	EL	EC1	EC2
l	m	n	o	p	q	r	s	t	u	SG1	SG2	←	→	△	▽
v	w	x	y	z	-	.	,	'	/	SP	BS	DEL	CLR	ENT	

Full keys, Horizontal, Lowercase Alphabets

Example) K8013

A	B	C	D	E
F	G	H	I	J
K	L	M	N	O
P	Q	R	S	T
U	V	W	X	Y
Z	-	.	,	'
SG1	/			SP
SG2	EU	EL	EC1	EC2
NUM	←	→	△	▽
BS	DEL	CLR	ENT	

Full keys, Vertical,
Uppercase alphabets

3.4 Text Input: the Text Screen

Create text data with the Text screen. There are two methods of creating text data: Open an existing Text screen and edit this screen using the GP Text Editor, or paste the text created with another editor onto the Text screen for the GP series using the [Cut] and [Copy] command.

The created text data can also be animated; there are two methods: Displaying text by a specified number of lines (specified by X-tag), and a list with error guidance (specified by A-tag).

Reference *Tag Reference Manual, 2.1 A-tag (Alarm Summary TEXT Display)/ 2.30 X-tag (Display Text Data)*

Usage Pattern
Open a Text screen by selecting the [Screen] menu's [New] command → Enter text. → Save the Text screen. → Quit the GP Text Editor. or by clicking on the icon.

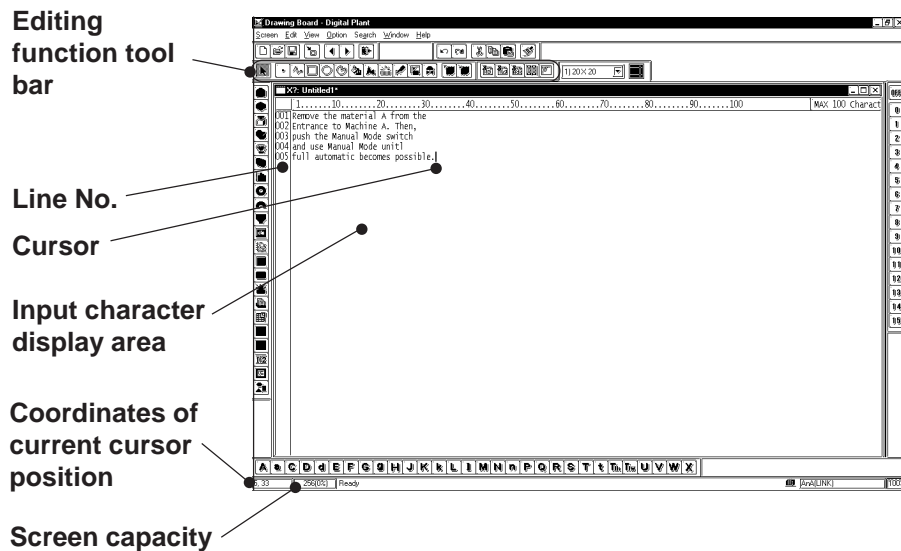

General description of the Text screen:



■ Editing Functions

The Editing Tool Bar icons and their corresponding functions are as follows:

Icon	Editing Tool	Description
	Cut	Used to delete the selected text, and store it in the clipboard. You can use this function to delete or move text.
	Copy	Used to store the selected text in the clipboard. Unlike the [Cut] command, the original text will not be deleted.
	Paste	Used to paste the data temporarily stored in the clipboard onto a desired place.
	Delete	Used to delete the selected text.



Icon	Editing Tool	Description
	Undo	Used to cancel the command executed immediately before, and return to the previous condition. (Undo)
	Redo	Used to redo the command canceled with the [Undo] command. (Redo)

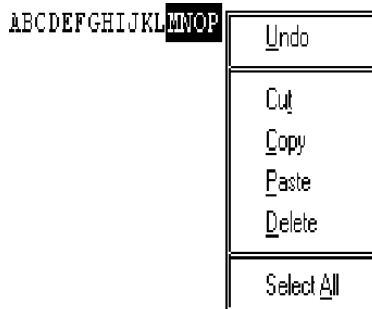

Note: When you select characters and click the right mouse button, the following shortcut menu appears.

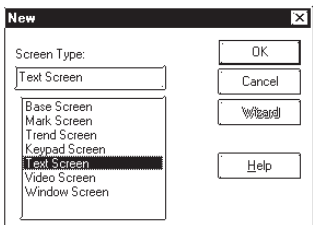

■ Input the Text

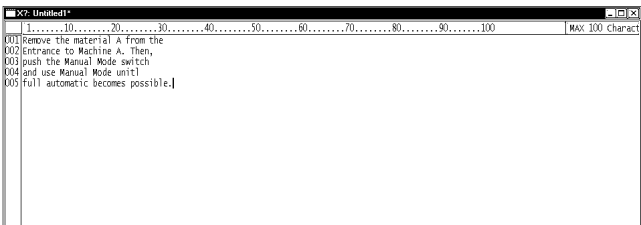
PROCEDURE	REMARKS								
<p>(1) Select the [Screen] menu - [New] command, or click on the  icon to open a Text screen.</p> <p>(2) Open a Text screen.</p>  <p>(3) Enter text in the text display area through the keyboard.</p> <p>Be sure to press the  key at the end of each line.</p> 	<p>Reference 1.1.3 ■ Opening a New Screen</p> <table border="1"> <thead> <tr> <th>Maximum number of characters</th> <th>GP type</th> </tr> </thead> <tbody> <tr> <td>40</td> <td>GP-H70, GP-270, GP-370, GP-377, GP-37W2, GP-377R, GP-2301H, GP-2300, GP-2301</td> </tr> <tr> <td>80</td> <td>GP-470, GP-570, GP-571, GP-870, GP-477R, GP-577R, GP-2401H, GP-2400, GP-2500, GP-2501</td> </tr> <tr> <td>100</td> <td>GP-675, GP-2600</td> </tr> </tbody> </table> <p>You can enter up to 512 lines on one screen. Line number 513 or subsequent lines cannot be displayed.</p>	Maximum number of characters	GP type	40	GP-H70, GP-270, GP-370, GP-377, GP-37W2, GP-377R, GP-2301H, GP-2300, GP-2301	80	GP-470, GP-570, GP-571, GP-870, GP-477R, GP-577R, GP-2401H, GP-2400, GP-2500, GP-2501	100	GP-675, GP-2600
Maximum number of characters	GP type								
40	GP-H70, GP-270, GP-370, GP-377, GP-37W2, GP-377R, GP-2301H, GP-2300, GP-2301								
80	GP-470, GP-570, GP-571, GP-870, GP-477R, GP-577R, GP-2401H, GP-2400, GP-2500, GP-2501								
100	GP-675, GP-2600								

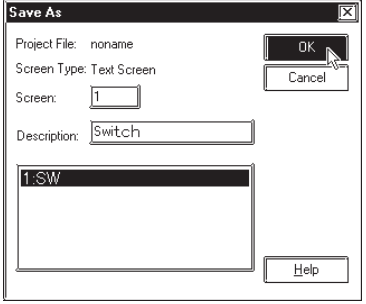

PROCEDURE	REMARKS
<p>(4)After entering text, save the Text screen.</p> 	

3.4.1 Editing Text

The GP-PRO/PB III provides the Cut, Copy, and Paste functions to edit text data. These functions improve your editing efficiency.

■ Cutting/Pasting Text

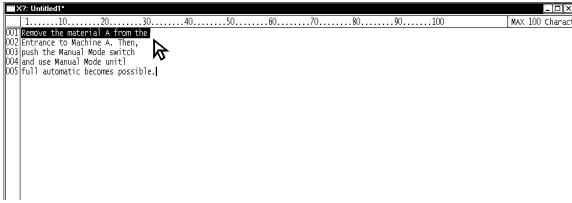
This function is used to delete selected text and store it in the clipboard^{*1}. You can copy the text onto a desired position using the [Paste] command.

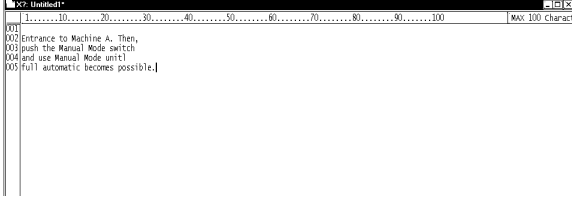

PROCEDURE	REMARKS
<p>(1)Select the text to be cut.</p>  <p>(2)Select the [Edit] menu - [Cut] command, or click on the  icon. The selected characters will be temporarily cut.</p> 	<p>To select several characters, drag the mouse within a desired text range.</p> <p>To select all the text, select the [Edit] menu - [Select All] command.</p> <p>To delete the selected data, perform steps (1) and (2) only.</p>

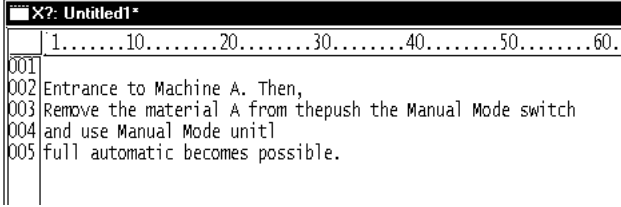
**1 When the [Copy] or [Cut] command is executed, the copied or deleted data are temporarily stored in the clipboard. When you execute the [Paste] command, the data stored in the clipboard can be pasted on a desired position.*

PROCEDURE	REMARKS
<p>(3) Move the cursor to the text's destination. Then, select the [Edit] menu - [Paste] command, or click on the  icon. The deleted characters will be pasted at the specified position.</p> 	



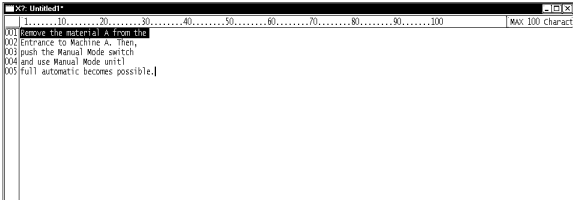

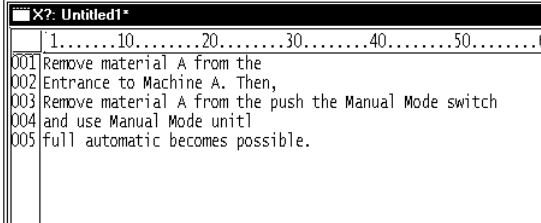
■ Copying Text

Copy selected text data, and store the text data into the clipboard.

PROCEDURE	REMARKS
<p>(1) Select the text data to be copied.</p>  <p>(2) Select the [Edit] menu - [Copy] command, or click on the  icon. The selected characters will be copied into the clipboard.</p> <p>(3) Move the cursor to the copy's destination. Then, select the [Edit] menu - [Paste] command, or click on the  icon. The text data stored in the clipboard will be pasted at the specified position.</p> 	<p>To select several characters, drag the mouse within the desired text range.</p> <p>To select all the text, select the [Edit] menu - [Select All] command.</p>

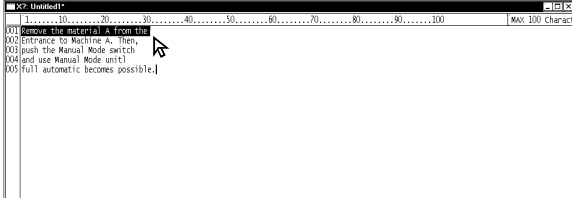

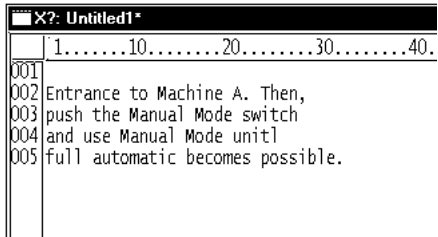
■ **Deleting Text**

Delete text data.

PROCEDURE	REMARKS
<p>(1) Select the text data to be deleted.</p> 	<p>To select several characters, drag the mouse within the desired text range.</p> <p>To select all the text, select the [Edit] menu - [Select All] command.</p>
<p>(2) Select the [Edit] menu - [Delete] command, or click on the  icon. The selected characters will be deleted.</p> 	<p>You can execute the same operation by pressing the <input type="text" value="Delete"/> key of your personal computer's keyboard, instead of clicking on the  icon.</p> <p>To cancel the [Delete] command, click on the  icon.</p>

■ **Searching for Text**

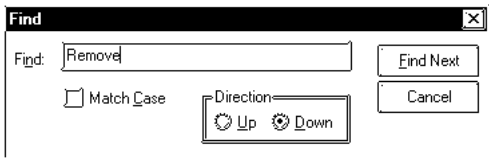
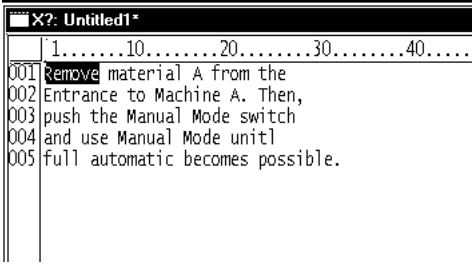
Search for a desired character string.

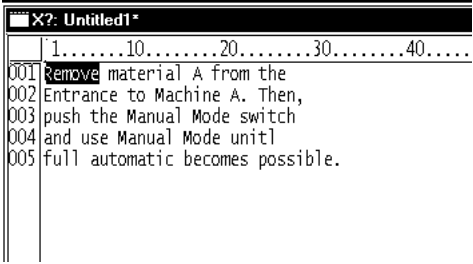
PROCEDURE	REMARKS
<p>(1) Select the [Search] menu - [Find] command.</p> <p>(2) Enter the character string to be searched for and select the search direction, i.e. upward or downward. The cursor position indicates the search start position.</p>  <p>(3) Click on the  button to execute the search operation.</p> <p>The search operation will be started in the specified direction. To continue the search operation for the same character string, click on the  button until there is no matching string. When there is no matching string, the search operation will stop.</p> 	<p>To differentiate between the uppercase and lowercase characters during the search operation, use the “Match Case” function.</p>

■ Utilizing Other Text Files

Other text files formatted for Windows can be used for the GP series. The procedure for using the Windows NotePad data for the GP series is as follows:

PROCEDURE	REMARKS
-----------	---------

(1) Start the NotePad, and open the file to be used.

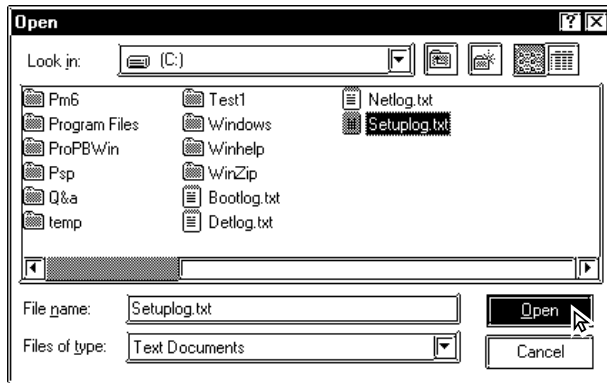

(2) Select the character strings to be used for the GP series.

```

-----
How to Use This Document
-----
To view Config.txt on screen in Notepad, maximize the Notepad window.
To print Config.txt, open it in Notepad or another word processor,
then use the Print command on the File menu.

In syntax lines, lowercase text signifies replaceable parameters and
uppercase text must be typed as it appears.
    
```

(3) Using the Notepad's [Edit] menu - [Copy] command, load the selected strings from NotePad into the clipboard.

(4) Move the cursor to the position where you wish to paste the selected text. Then, select the [Edit] menu - [Paste] command, or click on the  icon.

The strings stored in the clipboard will be pasted to the specified position.

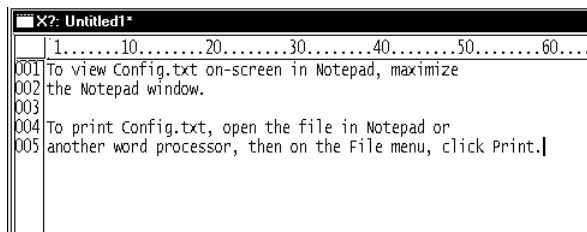

To differentiate between the uppercase and lowercase characters during the search operation, use the "Match Case" function.

Maximum number of characters	GP type
40	GP-H70, GP-270, GP-370, GP-377, GP-37W2, GP-377R, GP-2301H, GP-2300, GP-2301
80	GP-470, GP-570, GP-571, GP-870, GP-477R, GP-577R, GP-2401H, GP-2400, GP-2500, GP-2501
100	GP-675, GP-2600

■ Setting the Maximum Number of Characters per Line

You can set the maximum number of characters that can be entered per line. To set the maximum number of characters per line, move the ruler. The specified number of characters is displayed at the right of the ruler. When the input data exceeds the specified number of characters per line, the characters will be automatically entered in the next line. If you reduce the specified maximum number of characters after data input, the characters exceeding the current limit will be automatically entered in the next line.

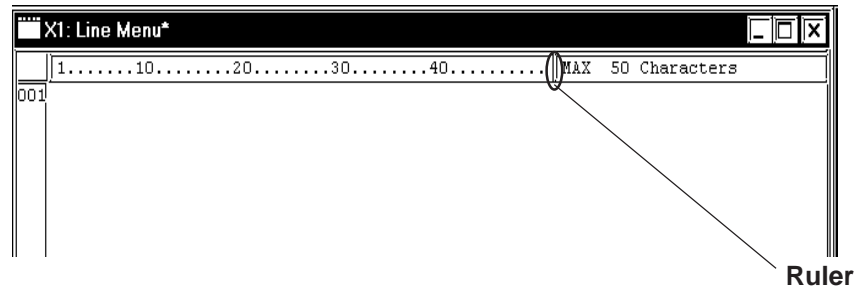

3.5 Creating an Image: the Image Screen

When converting an image data (bitmap: BMP file and JPEG: .JPG file) into an Image screen for the GP series, the image data can be displayed on the GP series panel.

You can load an Image screen onto a Base screen, Trend Graph screen, Keyboard screen or Window screen by selecting the [Draw] menu - [Load Screen] command.

Reference *2.2.10 Load Screens*

You can animate the Image screen by using the L-tag.

To convert image data into Image screen data for the GP series, use the [Utility] menu - [Convert Image] command.



- The Image Screen cannot be opened with the Screen Editor.
- You can also perform the conversion in the screen editor by selecting the [Draw] menu - [Convert/Image] command.

Reference *2.2.12 Convert (Import) Image*

- Image screens cannot be edited. To edit the image data, you must use the original file, and then convert this file into Image screen data. The Image screens can be checked on the screen list.

Reference *4.1.1 Listing/Copying/Deleting Screens*

- This command can convert image data of up to 800 x 600 dots. Note that any portion that does not fit into the GP screen will be cut off before conversion.

3.5.1 Image Conversion

Convert image data (bitmap: BMP file and JPEG: JPG file) created with other editor software or read with an image scanner into an Image (I) screen for the GP series.

Number of colors		1 bit	4 bits		8 bits		16-bit color	24-bit color	32-bit color
		2 colors (black & white)	16 colors	16-level gray scale	256 color	256-level gray scale			
Windows BMP/DIB	*.BMP	○	○	○	○	○	○	○	○
Windows BMP/DIB(RLE4)		-	○	○	-	-	-	-	-
Windows BMP/DIB (RLE8)		-	-	-	○	○	-	-	-
JPEG	*.JPG	-	-	-	-	○	-	○	-

With a color Image screen, the data volume becomes large, but the GP series' display speed is increased. With a monochrome Image screen, the GP series' display speed is slightly lowered, but the data volume can be reduced. Select a color or monochrome Image screen according to your purpose.

If the data volume is too large to be displayed on one screen, the converted data will be divided into several screens (up to nine screens).



- Make sure that the original image data's longitudinal dimension ("X" for the horizontal type, and "Y" for the vertical type in the figure below) is a multiple of "4" for color data, or a multiple of "8" for monochrome data. Otherwise the fractional data will be deleted from the right edge of the screen after conversion.

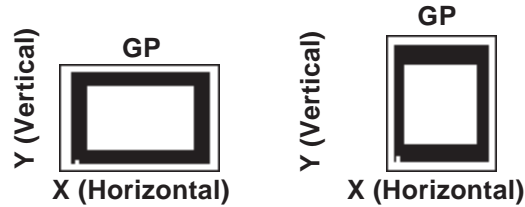

- If the longitudinal dimension of the original image data is less than "4" for color data, or less than "8" for monochrome data, the image data cannot be converted.

■ Converting/Placing an Image: [Source]

Specify the image file to be converted. The information on the specified image file will be displayed.

Enter the name of the image file to be converted, or select the image file from the file list by clicking on the [Browse] button

Displays information on data colors (e.g. 16 colors, 256 colors)

Displays the size of the image file

Displays the dimensions (horizontal x vertical) of the image data

Select the image file to be converted

Displays the image of the image file to be converted. However, this image is different from the image that will be displayed on the GP series

Register the above settings to execute the image conversion. If you save the converted image data, the image screen of the screen number specified in [Screen Setting] will be created

■ **Converting/Placing an Image: [Effects]**

Specify the brightness, resolution, blinking, compression, and mirror functions for the converted image data.

Used to set the brightness and display quality automatically

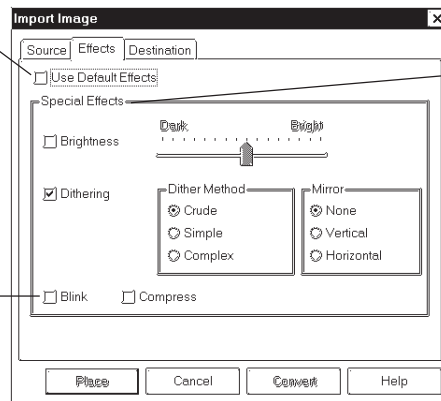

Used to manually set the individual options of the brightness and display quality

When 256-colors are selected, "Blink" cannot be selected

◆ **Use Default Effects**

When you specify Use Default Effects, the original data will be automatically converted into the image data with the optimum brightness and display quality.

◆ **Brightness**

Used to convert bitmap data according to the brightness level. The reference value can be changed between levels "0" and "15". A larger value indicates a brighter image, and a smaller value indicates a darker image.

◆ **Dithering**

Used to set the converted data's display quality.

◆ **Blink**

Used to make the converted data blink.



Blink cannot be used when the screen is displayed at 256 colors.

◆ **Compress**

Used to compress the original bitmap data during conversion.

◆ **Mirror**

Used to replace the original bitmap data symmetrically relative to the X-axis or Y-axis during conversion.

■ Converting/Placing an Image: [Destination]

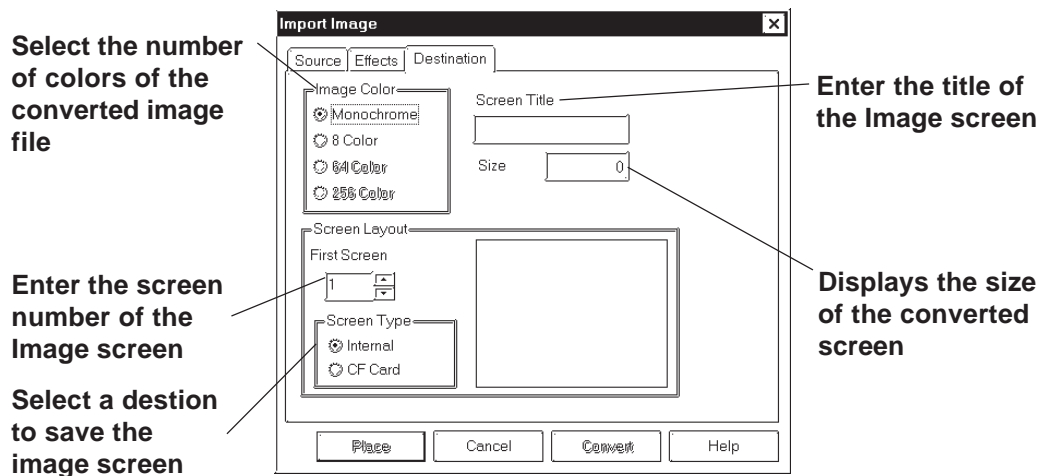

◆ Image Color

Select the type of the converted bitmap file: Monochrome, 8-colors, 64-colors or 256-colors. The screen size and the number of screen divisions vary depending on the selected type. Select "256 colors with No Blk" mode on the GP System Setup dialog box before selecting the "256 Color" option on the GP2000 (except GP-2301HL, GP-2301HS, GP-2300L, GP-2300T and GP-2501S) series.

▼ Reference ▲ 6.1 ■ Tab Setting Items ◆ Initial Screen Settings

◆ First Screen

Enter the screen number of the Image screen. If no screen number is specified, an Image screen of the currently displayed screen number will be created.

◆ Screen Type

Select whether the image screen is to be saved on the GP's internal memory or the CF card.

▼ Reference ▲ Tag Reference Manual, 4.4 Using the CF Card



- You can select the CF card if your GP is a GP77R series or a GP2000 series. Using the GP77R series requires the optional Multi Unit.
- When the CF card is specified, the drawing speed on a screen where the image screen is placed become slower than GP memory is specified.

◆ Screen Title

Enter the title of the Image screen. Even if the converted data are divided into several screens, only one title can be specified for one original file.

◆ Size

Displays the size of the converted screen.

■ **Converting an Image**

Convert an image file into Image screen data.

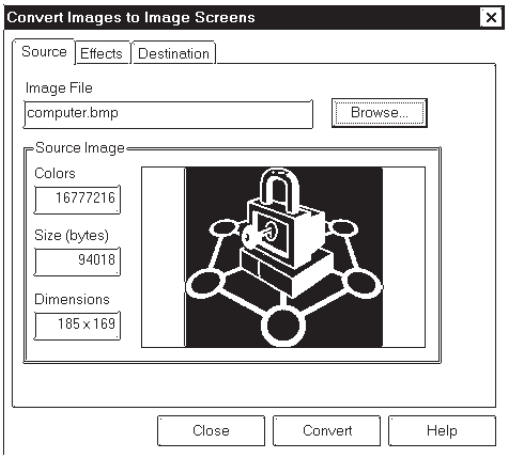
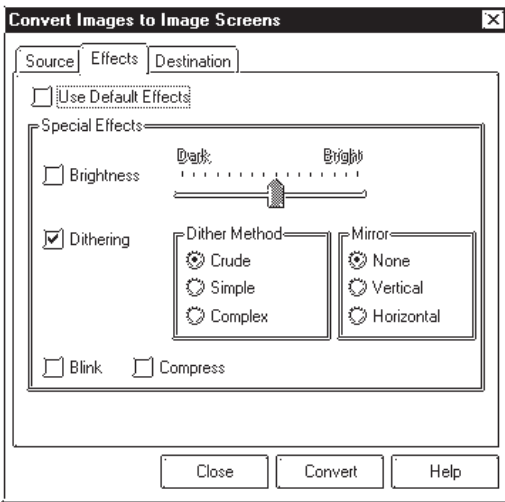
PROCEDURE	REMARKS
<p>(1) Select the [Utility] menu - [Convert Image] command of the Project Manager.</p> <p>(2) Click on the Browse... button, and select an image file to be converted. The color type, data volume, screen size and image data of the bitmap file will be displayed.</p>  <p>(3) Specify the conversion parameters. If the data volume is too large to be displayed in one screen, the image data will be divided into several Image screens.</p> 	<p>If the original data are monochrome, these conversion parameters cannot be specified.</p> <p>The “Blink” feature can be specified for the GP-571T, GP-675, GP-377S, GP-377R, GP-577R and GP2000 series units only.</p>

PROCEDURE	REMARKS
-----------	---------

(4) Enter the screen number and title of a new Image, and designate Screen Type.

If you do not set a title, the title of the original Image file will be specified.

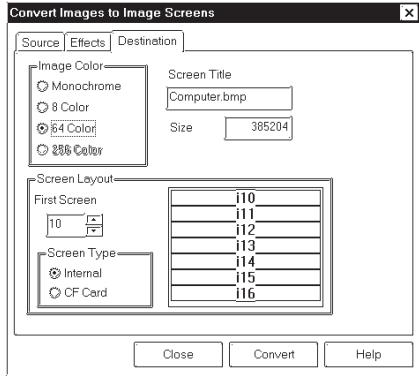

(5) Click on the Convert button to perform data conversion.

The image data conversion starts. Then, the converted image will be displayed.

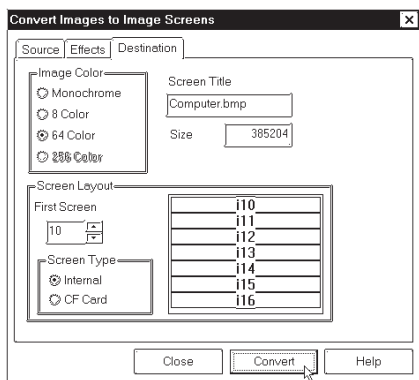

(6) If the displayed image is correct, click on the Save button.

An Image screen is created.

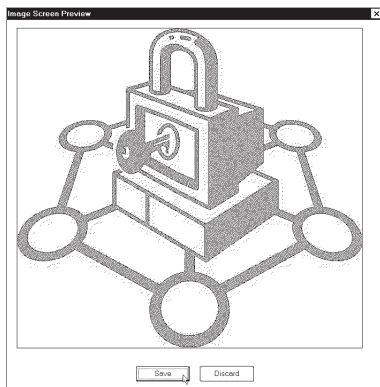

The “64-color” mode can be specified for the GP-571T, GP-675, GP-377S, GP-377R, GP-577R and GP2000 series only.

The “256-color” mode can be specified for the GP2000 (except GP-2301HL and GP-2300L) series only. **Reference** 6.1 **Initial Screen Settings**

The number of colors specified for [Screen Color] must be equal to the number of display colors supported by your GP series.

- If the number of colors is different, the display speed will be lowered.
- Any colors that are not supported with your GP series cannot be displayed.

Only when your GP type is the GR-77R or GP2000 series, the CF card can be specified in the [Screen Type] section.

Reference Tag Reference Manual, 4.4 Using the CF Card

If the same screen number already exists, the system asks if you want to replace the existing screen with the one you are attempting to save.

If so, select Yes; otherwise, select No.

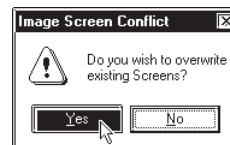

To cancel conversion, click on the Discard button.

When an image is converted by selecting the [Convert Image] command from the [Draw] menu on the Screen Editor, pressing the [Place] button allows the converted image screen to be placed.

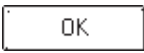
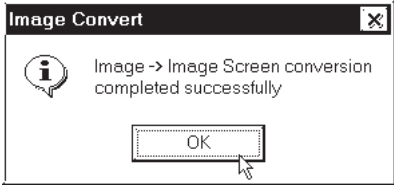
PROCEDURE	REMARKS
<p>(7) Click on the  button to quit the conversion mode.</p> 	<p>Reference 2.2.12 <i>Convert (Import) Image</i></p> <p>Select the [Load Screen] command from the [Draw] menu to place the converted image.</p> <p>Reference 2.2.10 <i>Load Screens</i></p>

3.5.2 Compressing/Decompressing an Image Screen

If the size of the Image screen is large, you can compress it to reduce the data size. The data is compressed to one-fifth the size of the source data. The compressed Image screen data can then be displayed directly to the GP series. With the compressed Image screen, however, the GP series' display speed will be slower.

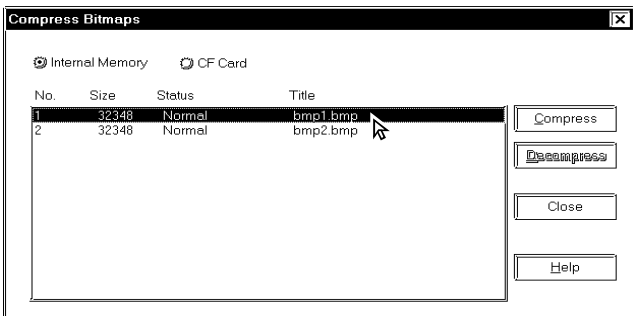
PROCEDURE	REMARKS
<p>(1) Select the [Utility] menu - [Compress Bitmap] command of the Project Manager.</p> <p>(2) Select the screen to be compressed or decompressed from the list.</p>  <p>The compression and decompression procedures are separately described as follows:</p>	<p>To compress an Image screen (bitmap data) of another project, select the project.</p> <p>Reference 1.1.2 ■ <i>Selecting an Existing Project</i></p> <p>To select several screens, click on the screen numbers while pressing the [Shift] key.</p> <p>To select a specified screen, click on the screen number while pressing the [Ctrl] key.</p> <p>If the CF card is specified in step (2) when your GP type is the GP-77R series or GP2000 series, the image screen on the CF card can be compressed.</p> <p>Reference <i>Tag Reference Manual, 4.4 Using the CF Card</i></p>

PROCEDURE	REMARKS
-----------	---------

[Compression]

(3) Click on the **Compress** button to execute data compression.

The process is finished when the word “Compressed” appears.

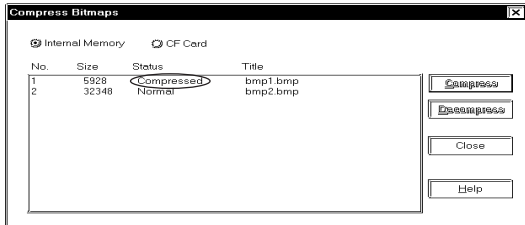

[Decompression]

(3) Click on the **Decompress** button to perform data decompression.

The process is finished when the word “Normal” appears.

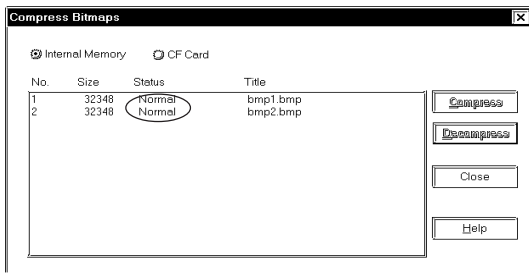

3.6 Video Data Display (V Screen)

Use a v-tag to call up the video window on the Video Screen (V file) onto the Base Screen (V file). This feature allows the video display to be displayed on the GP screen when necessary.



This feature is supported only by the GP-2500T and GP-2600T. The optional VM Unit is required.

The following two procedures can be used to display video windows: (1) Use a v-tag to display the video window on the specific Base Screen (B); or (2) display the video window as a global window for all screens.

In procedure (1), place a v-tag on the Base Screen (B). Select the [v-Tag] from the [Tag] menu to make the settings.

▼Reference▲ *Tag Reference Manual, 2.28 v-tag (Extended Video Window Display)*

A v-tag can be set up only when "Extend(small v-tag)" is enabled. Select this mode using the following procedure before setting up a v-tag. Select [GP Setup] from the Project Manager and select [Extended Settings] and [Video Settings].

(2) For details of the global display:





▼Reference▲ *3.6.2 Video Window Settings*

Select the [Video Setting] command from the [Tag] menu on the Video Screen (V) to set up a video window. If necessary, select [T-tag] from the [Tag] menu to set up a touch-switch for use in the video data display.

The environmental settings for video operation can be made by selecting [Video Setting] on [Extended Feature Settings] from the [GP Setup], or by selecting [Video Operation Settings] on the OFFLINE menu of the GP unit.



GP's screen drawing objects cannot be placed on video screens. You can check the contents of your video screens via the [Screen List] feature.

▼Reference▲ *4.1.1 Listing/Copying/Deleting Screen*

Usage Pattern	
<ul style="list-style-type: none"> To Create a Video Screen <p> [Screen] → [New] → Click on Tag menu → Click on Video Settings or Click on  icon → Click on  to set up a video screen Select "Video Screen" → Save the video screen → Click on Tag menu → Click on T-Tag → Save the video screen or Click on  to set up a touch switch </p> To Create a Base Screen <p> Open the Base screen → Click on Tag menu → Click on v-Tag → Save the Base screen or Click on  to set up video settings. </p> To use the GP Setup screen to enter video setting data. <p> → Click on Screen/Setup menu → Click on GP-Setup → Extended Settings → Video Settings Click on  to set up video settings. </p> 	

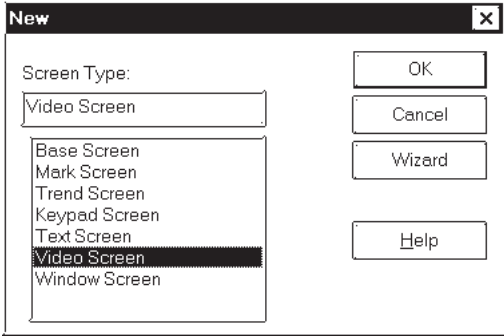

This feature is enabled by performing the above procedure.

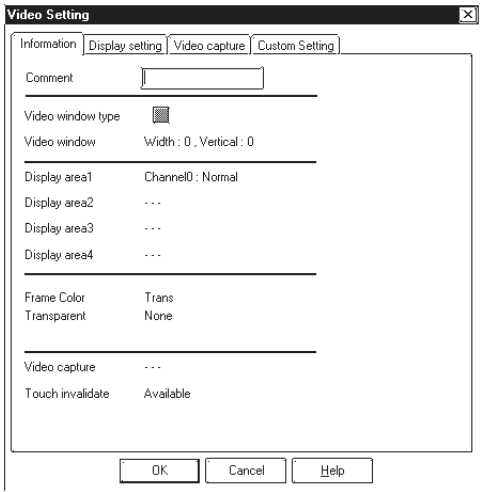
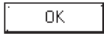
■ Entering Video Settings

PROCEDURE	REMARKS
<p>(1) From the screen editor, select the [Screen] menu - [New] command, or click on the  icon.</p> 	<p>Reference <i>1.1.3 Opening/ Closing/Saving a Screen</i></p>
<p>(2) Select the “Video Screen”.</p> <p>The “Wizard” button is enabled only when video screen is selected. Clicking on the “Wizard” button calls up a dialog box that explains the video settings. Basic settings can be made in the Wizard dialog box. For detailed settings, adjust the settings on the [Video Setting] dialog box in step (3).</p>	
<p>(3) From the [Tag] menu, select [Video Setting], or click on the  icon.</p>	
<p>(4) Enter the desired video settings in the [Video Setting] tab screens.</p> 	
<p>(5) After all settings are entered, click on the  button.</p>	<p>Reference <i>Tag Reference Manual, 2.28 v-tag (Extended Video Window Display)</i></p>
<p>(6) Place the video data display area icon where you wish to have the video display on the GP screen. Re-size the icon to reflect the actual size of the display.</p>	

■ Create a Touch Switch to Activate the Video Data

Place a touch switch with a T-tag on the video data display area. The touch switch can be used for various applications. For example, touching the video window changes the window size according to the T-tag settings.

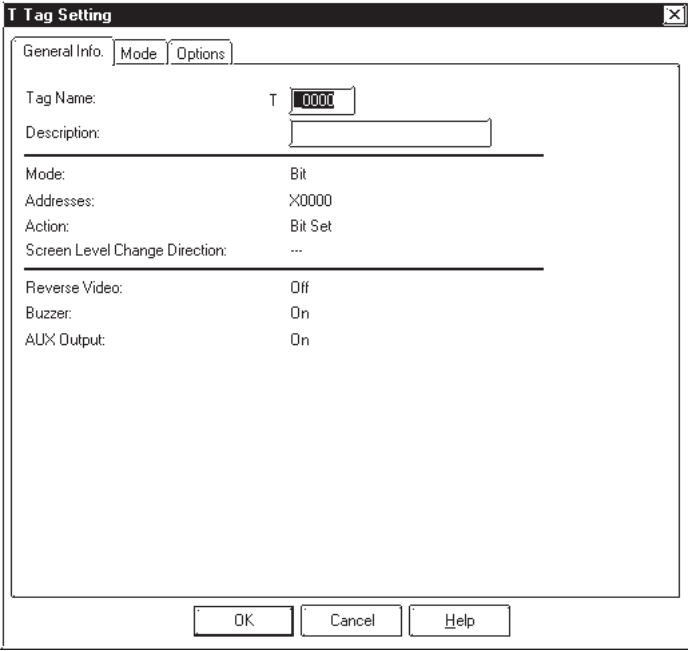
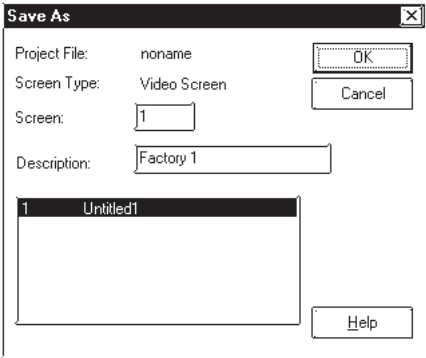
PROCEDURE	REMARKS
<p>(1) Select the [Tag] menu - [T-tag] command, or click on the  icon.</p> <p>(2) After all settings are entered, click on the  button.</p>  <p>(3) Place the tag on the video data display area.</p> <p>(4) After all settings are entered, save the video screen.</p> 	<p>▼Reference▲ Tag Reference Manual, 2.23 T-tag (Touch Panel Input)</p> <p>T-tags have the following features on a video screen.</p> <ul style="list-style-type: none"> Bit operation Set Reset Momentary Word Operation Mode Set 16 bit Set 32 bit <p><i>Interlock and Reverse display features are not available.</i></p> <p>▼Reference▲ 1.1.3 ■ Saving a Screen</p> <p>You must set at least one Video Setting tag on the video screen. If you do not, the screen cannot be saved.</p>

■ Enter v-tag Settings

PROCEDURE	REMARKS
-----------	---------

(1)Open a Base Screen.

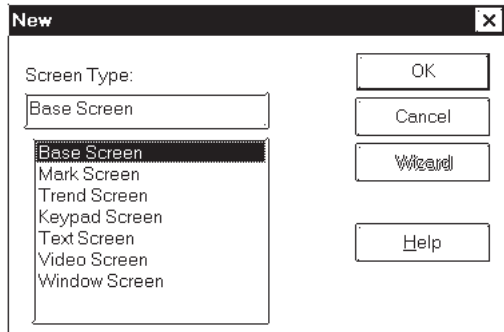

(2)Select the [Tag] menu - [v-tag] command, or click on the  icon.

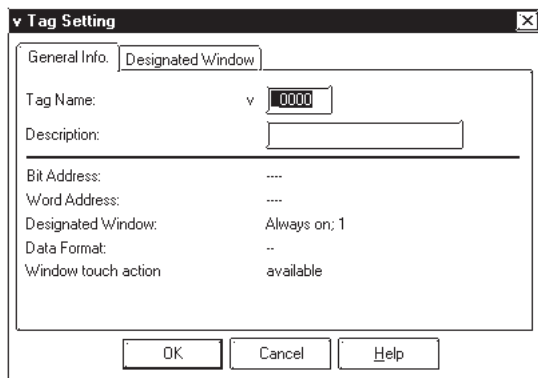

(3)After all v-tag settings are entered, click on the  button.

Reference *Tag Reference Manual, 2.28 v-tag (Extended Video Window Display)*

■ Use the [GP Setup] area's [Video Setting] selection

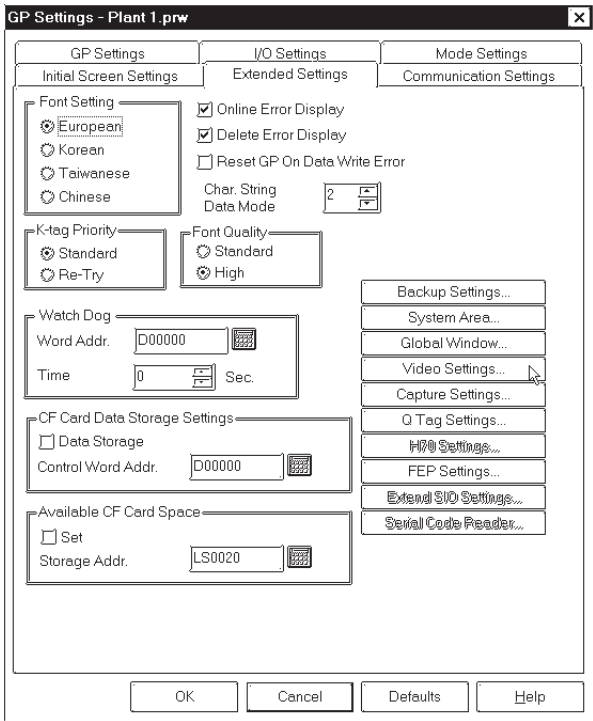
PROCEDURE	REMARKS
<p>(1) Click on the Project Manager's GP Setup icon, or click on the [Screen/Setup] menu's [GP Setup] selection.</p> 	
<p>(2) Click on the [Extended Settings] tab and then click on the [Video Settings] button.</p> 	
<p>(3) Specify settings for the parameters on [Video Setting].</p>	<p>▼ Reference 3.6.1 Video Settings</p>

3.6.1 Video Settings

This section describes the procedure for specifying the Video Setting. Select Standard or Extended Mode according to the GP Type.

Note: Only "Standard Mode" can be enabled with the GP-570VM and GP-870VM.

Used in the GP570VM and GP870VM. Cannot be used via a v-tag, only with a V-tag.

This feature is used with the GP2000 series unit's [Extend] mode. It cannot be used via a V-tag, only with a v-tag.

Designate whether a Video Control Start Address is used or not. Enabled only in [Extend] mode.

Reference Tag Reference Manual, 4.10 VM Unit Extended Features

Set when the Video Window is used as a Global Window.

Reference 3.6.2 Video Window Settings

◆ Video Control Start Address

This area (Video Control Area) is used to designate the various control features for the display of the video screen on a GP.

Reference Device/PLC Connection Manual, 1.1.2 LS Area Structure

Use the following table when setting the Video Control Area's start address.

Mode	Video Control Area Start Address
Standard	LS20 to LS2010, LS2096 to LS4072 (to LS8170 for GP2000 series units)
Extend	LS20 to LS1989, LS2096 to LS4053 (to LS8149 for GP2000 series units)

In Standard mode, 22 words are automatically allocated for the Video Control Area, starting from the Start Address. In Extend mode, 43 words are allocated.

Reference Tag Reference Manual 4.9.3 Standard Mode

Reference Tag Reference Manual 4.9.4 Extended Mode

◆ Center Zoom

Clicking on this selection, if the mode is changed from Standard to Zoom, designates that the center of standard mode's video screen will be enlarged. This selection is enabled only in Extend mode.

◆ **Video Input/Display Mode**

Used to designate the type of input signal and display mode used.



Note: Display Mode (from a PC) cannot be used if this screen is set to Extend Mode.

◆ **Brightness/Contrast/Tone/Mode**

Used to designate the GP display settings used for each input channel.

3.6.2 Video Window Settings

This selection is used when using the video window as a global window. The setting method is the same as that used for Global Window. When global mode is used, however, the local v-tag cannot be used. The control address used is the user's designated area.

■ **Absolute**

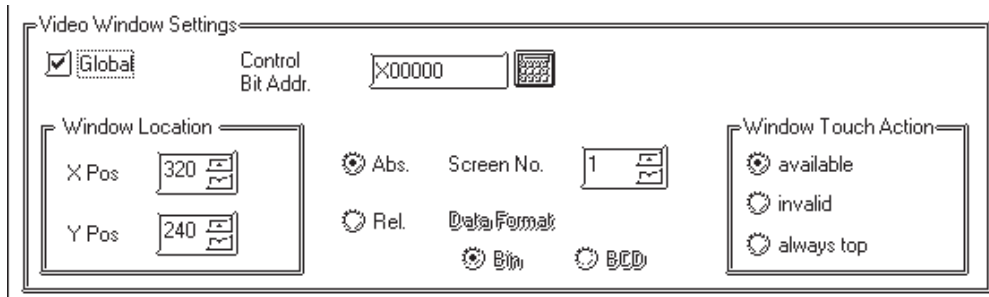

◆ **Control Bit Addr.**

When this bit is designated as “0”, the window is not displayed. When it is “1”, the window will appear.

◆ **Window Location**

This position uses the absolute value of the data entered to designate the video window's top left corner. At this time, that point becomes the video screen's zero (0,0) point.

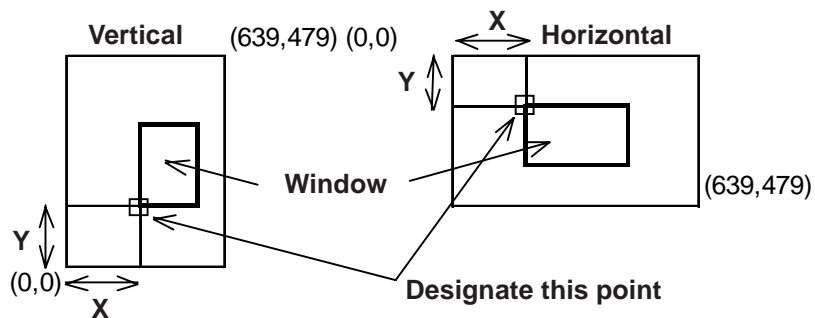

◆ **Screen No.**

Designate the screen number of the video screen to be displayed.

◆ **Window Touch Action**

- Available** If the desired window is currently behind another window, touching anywhere on the desired window will bring that window to the front.

- Invalid** If the desired window is currently behind another window, touching anywhere on the desired window will have no effect and the window will remain in its current position.

- Always top** This setting keeps the desired window always on the “top” (front most) of the display. However, if the GP unit’s system window is used (display of parameters, errors, alarm messages, etc.), this screen will be placed behind the system window

■ **Relative**

This setting uses a variable to designate the display screen and the display position. Thus, as data is saved to the designated Word Address, the display will change.

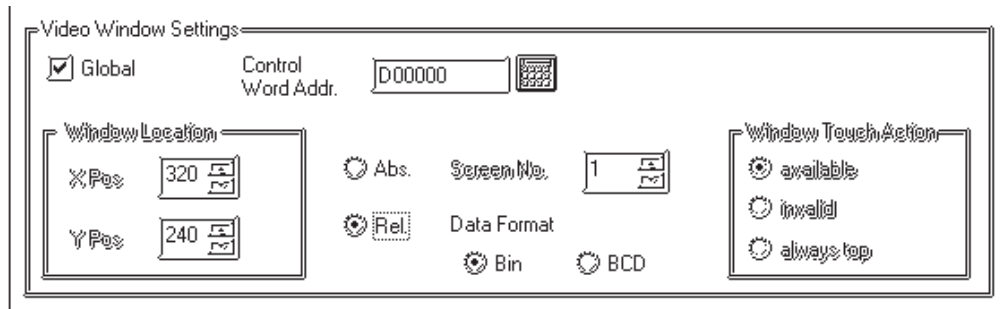

◆ **Control Word Addr.**

When this bit is designated as “0”, the window is not displayed. When it is “1”, the window will appear.

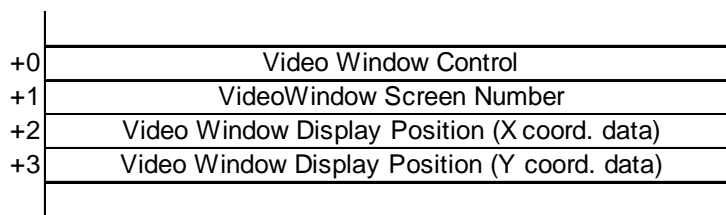

[Window Control]

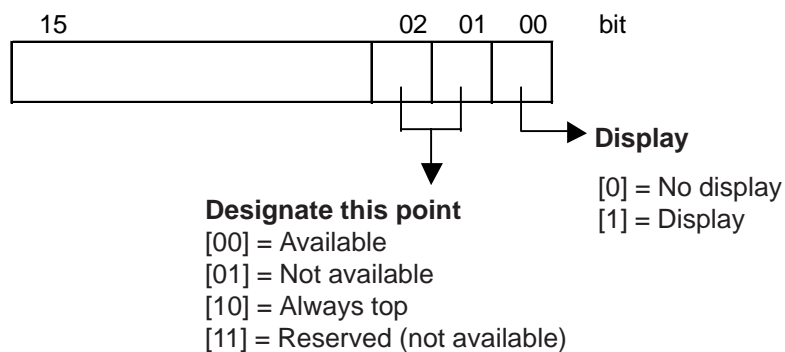

◆ **Data Format**

BIN

BCD

Designates the type of data used for the display position and window number data.

3.7 Window Display: Window (U) Screen and Base (B) Screen

3.7.1 Overview of Window Display

Call up the windows registered on the Window Screen (U) or Base Screen (B) and display them on the Base Screen (B).

Additional windows can be displayed on the GP screen when necessary.

Example: Make the settings for displaying a bar graph by turning ON the window display switch.

<GP Screen>

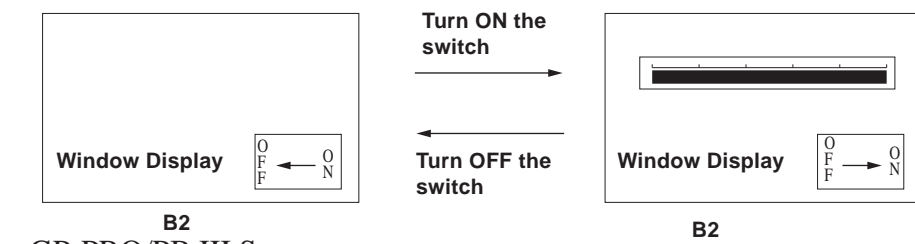

<GP-PRO/PB III Screen>

1) Registering a window on the U Screen

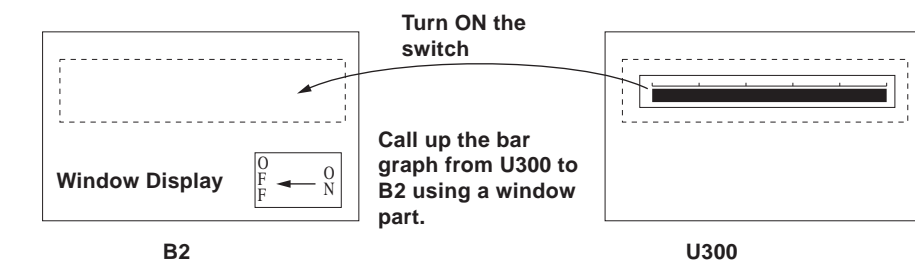

2) Registering a window on the B Screen

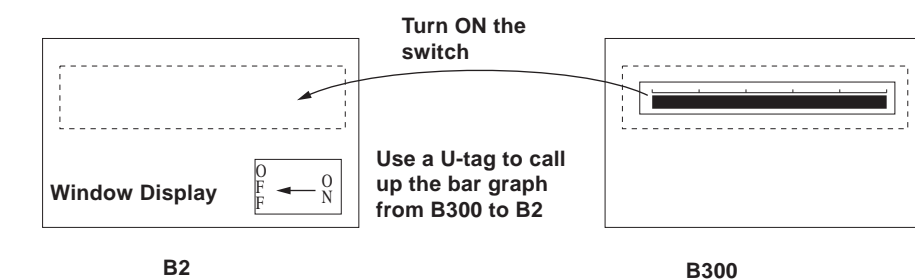

Window Registration can be performed on the Window Screen (U) or Base Screen (B).

The following two types of Window Display are available.

◆ Local Window Display

Set up a U-tag to call up a window registered on the Base Screen (B) to the Base Screen (B).

▼ **Reference** ▲ 3.7.3 Window Registration on the B Screen
Tag Reference Manual; 2.26 U-tag (Window Display)

Set up a window part or a U-tag to call up a window registered on the Window (U) to the Base Screen (B).

▼ **Reference** ▲ 2.1.23 Window Parts, 3.7.2 Window Registration on the U Screen, Tag Reference Manual; 2.26 U-tag (Window Display)

	Window registered on the B Screen	Window registered on the U Screen
Window part	Not available	○
U-tag	○	○

◆ Global Window Display

Displays a single window on all Base Screens (B) as a global window. To call up the window, make the "Global Window" settings on the OFFLINE settings of the GP unit or on the [GP Setup] of the Program Manager in GP-PRO/PB III.

▼ **Reference** ▲ Tag Reference Manual, 2.26 U-tag (Window Display), GP series User Manual, 5.3.3 Global Window Setup



K-tags, U-tags, V-tags, v-tags, trend graphs (T Screen and parts), Keypad Input Display and Logging Display will not function from the registered window.

3.7.2 Window Registration on the U Screen



Call up a window that has been registered on the Window Screen (U) onto the Base Screen (B)



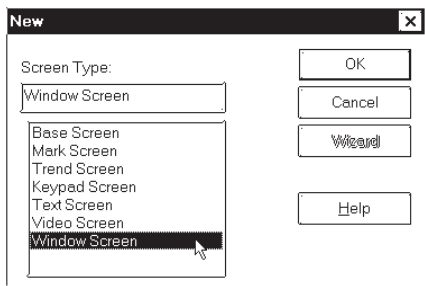
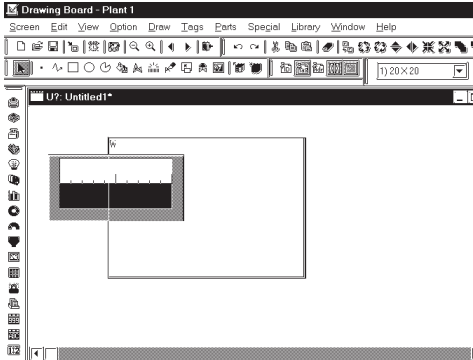

The window can be easily called up with the window part placed on the Base Screen pasted to the Base Screen.

■ Window Screen

Usage Pattern			
[Screen]	→	[New Screen]	→ OK → Create a window.
[Part]	→	[Window Part]	→ Specify the window. → Place.
		or	
			

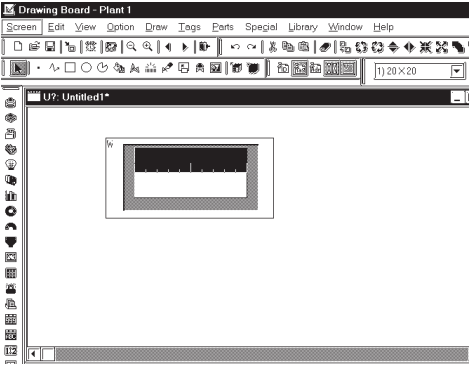
This section describes the procedure for calling up a window display of a bar graph onto B2, following the example in the section Overview of Window Display in 3.7.1.

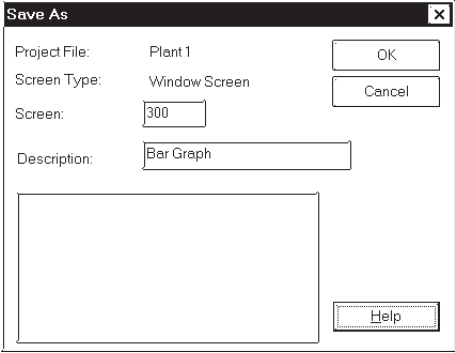
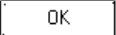
PROCEDURE	REMARKS
<p>(1) Select [New] from the [Screen] menu, or click  to select [Window Screen]. The Window Screen (U) opens and a window area with a square frame is displayed.</p> 	
<p>(2) Draw the bar graph to be called up to the B2 screen.</p> 	<p>Click the border of the window area and eight  will appear on the screen. With the mouse, drag  to change the size of the window area.</p>

PROCEDURE	REMARKS
<p>(3) Adjust the window area so that it surrounds the bar graph.</p>  <p>(4) Save the Window Screen (U). Select the [Save As] command from the [Screen] menu, or click .</p>  <p>Enter the "Screen Number" and "Title." Click the  button.</p> <p>(5) Open the Base Screen (such as B2) to be used for the window display.</p> <p>(6) Select [Window Parts] from the [Parts] menu, or click .</p>	<p>The Window Registration number that is added to the B Screen (displayed in red if it is already registered) cannot be selected as the "Screen" number.</p> <p>Reference <i>3.7.3 Window Registration on the B Screen</i></p> <p>A U-tag can be used as well to display the Window Screen onto the Base Screen.</p> <p>Reference <i>Tag Reference Manual, 2.26 U-tag (Window Display)</i></p>

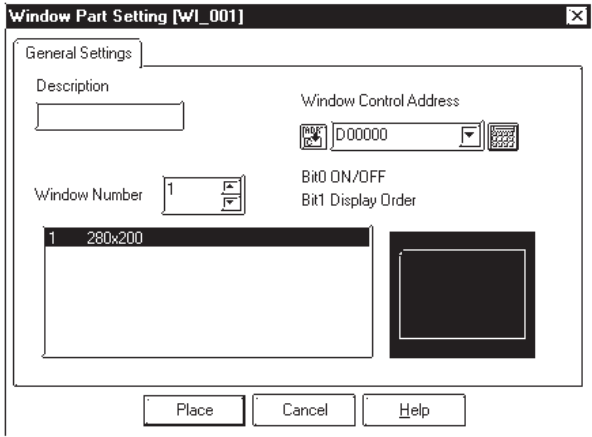
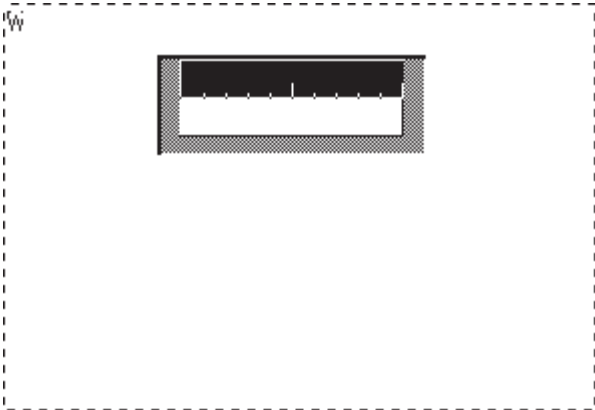
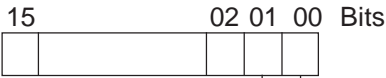
PROCEDURE	REMARKS
<p>(7) Select the window to be displayed from the "Window Number" field. Specify the Window Control Address as well.</p>  <p>(8) Click the [Place] button after setting all attributes. The border of the window area is displayed on the drawing area.</p> <p>(9) Click on the position where the window is to be placed.</p> 	<p>[Window Control Address]</p>  <p>Changing the order of window layers [0]: Touching the window will change the order of the layer. [1]: Touching the window will NOT change the order of the layer.</p> <p>Show [0]: Hide the window [1]: Show the window</p> <p>Reference <i>Tag Reference Manual, 2.26 U-tag (Window Display)</i></p> <p>If the specified position overlaps the objects on the Base Screen, the objects are hidden while the window is displayed.</p>

3.7.3 Window Registration on the B Screen

To display a window during the GP's RUN mode, you must first register it; the window can be either all or part of a Base screen.

There are two types of window displays, Global and Local, and both are registered and deleted using the same methods.

Reference *Tag Reference Manual, 2.26 U-tag (Window Display)*

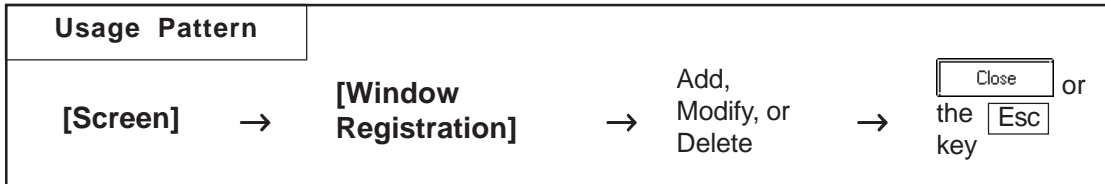

No.	Screen	Size	Description
1	1	056x059	Data Entry Keypad
2	12	056x059	Setting Entry Keypac

Lists the Window's registration information (points to the table)

Adds new window registration data (points to 'Add...')

Modifies window registration Size and/or Description (points to 'Modify')

Copies a registered window (points to 'Copy')

Deletes a registered window (points to 'Delete')

Other buttons shown: Close, Help.

Note: Windows registered on the U Screen are displayed in red. Editing, deleting and copying are not available here.

■ Registering Windows

Here, an additional window can be registered. When clicking on the button, the window registration setting dialog box will appear.

Reference Refer to next page: **■ Registering a Window**

■ Deleting Windows

This command deletes a registered window. Use the above dialog box to select the window to be deleted, then click on the button and a dialog box will appear to confirm your command. Click on the button to delete the window; click on the button to cancel the command.

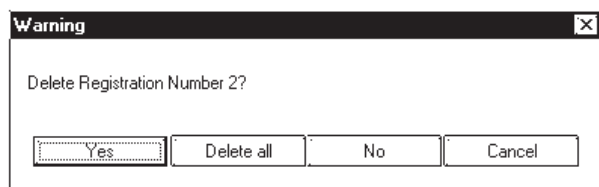

■ Editing Windows

Screens registered as a window can be edited, and their names can be changed. First, select the window to be changed from the Window Registration of the Registration list; then, click on the button. The coordinates of windows are changed in the same manner as adding a window. After the window's coordinates have been designated, the [Add To List] Dialog box will appear and the title can be changed. When the button is clicked on, the changed items will be registered. To cancel the changes, click on the button.

▼ Reference ▼ ■ Registering a Window, steps (3) to (5)

If a registered window is copied, the same area (location) of another window can be registered as a window. Any registration number, screen number being registered, and title can be changed.

▼ Reference ▼ 2.6 ■ Copying a Window Registration

■ Registering a Window

Here, part or all of a screen is registered as a window.

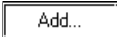
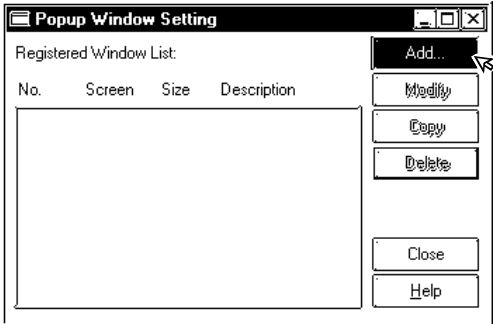
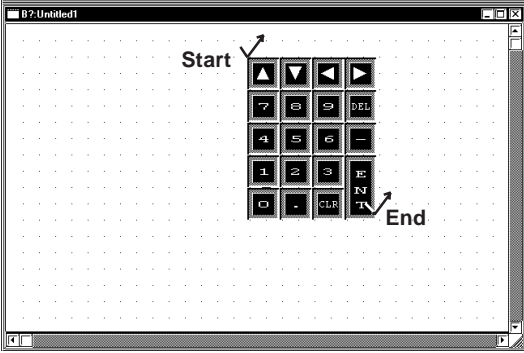
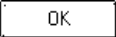
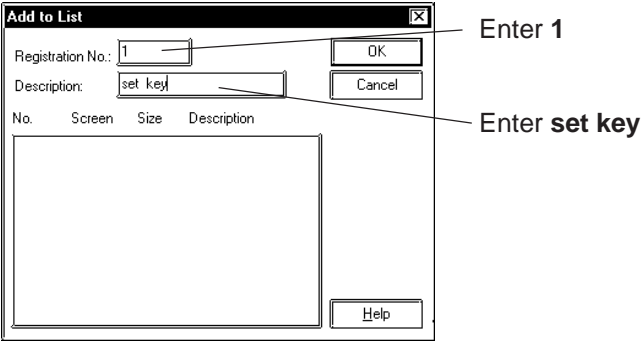

PROCEDURE	REMARKS
<p>Open the screen to be registered as a window.</p>	

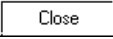
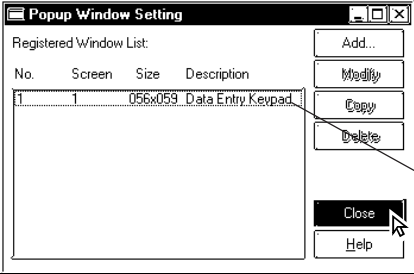
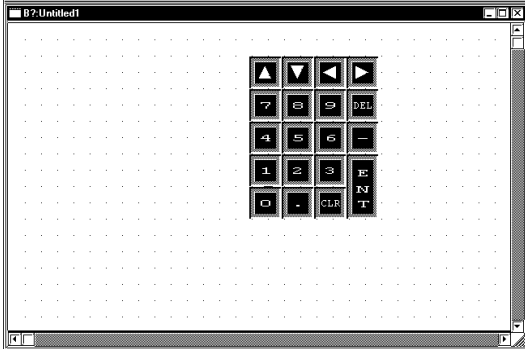
PROCEDURE	REMARKS
<p>(1) Select pull down menu [Screen]'s [Window Menu].</p> <p>(2) Click on the  button.</p> 	<p>When you are working on a new screen that has not been saved, and you attempt to Add (register) a window, the [Save As...] dialog box will appear. First, you must save the screen, then you can register the window.</p> <p>Reference 1.1.3 ■ <i>Saving a Screen Under a Different Name, step (2)</i></p> <p>Reference 2.2.3 <i>Square/Rectangle</i> ■ <i>Drawing a Square/Rectangle</i></p>
<p>(3) Designate the area that you wish to register by Left-dragging the cursor to enclose it.</p> 	<p>The x coordinates for the window display can only be set up in 8 dot intervals, i.e. the cursor will snap from one 8 dot unit to another. You can set up the Y coordinates anywhere you wish.</p>
<p>(4) Enter the Registration No. and title, and then click on the  button. The window will be registered.</p> 	<p>The "Screen Number" used on the Window Screen cannot be selected as the Registration Number.</p> <p>The Description entered can be up to 30 characters.</p> <p>Windows can be registered up to 1189 for each Project File.</p>

PROCEDURE	REMARKS
<p>(5) Click on the  button to finish registration.</p> <p>When registering another window on the same screen, do not quit here, rather, start again from step (2).</p>  <p style="text-align: center;">↓</p> 	<p>[Window Registration]</p> <p>By changing Size in the Registered Window List of the Popup Window Setting, a larger number of registered items can be displayed.</p> <p>Place the cursor at the bottom-right corner of the screen. The cursor changes to a black arrow. Adjust the size of the dialog box while holding the left mouse button.</p>

■ Copying Window Registration Data

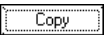
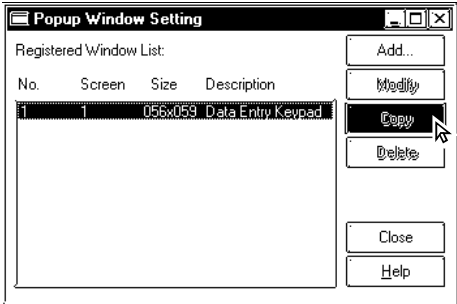
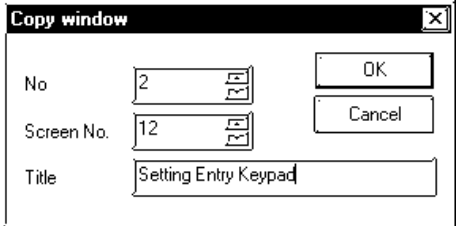
If a registered window is copied, the same area (location) of another window can be registered as a window.

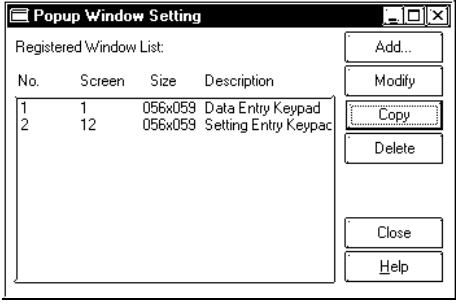
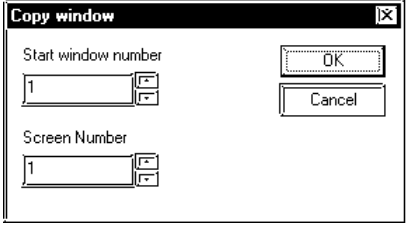
PROCEDURE	REMARKS
<p>(1) Select the [Screen] menu - [Window Registration] command.</p> <p>(2) Select a window to be copied, and then click on the  button.</p>  <p>(3) Enter the registration number of a new window, the screen number to which the window is to be copied, and that screen's title.</p>  <p>(4) Click on the  button to copy the window.</p> 	<p>To select multiple windows at a time, drag through the windows being selected on the list, or select those windows by clicking on them while holding down the Shift or Ctrl key.</p> <p>If multiple windows have been selected in step (2), specify the start window number and screen number of the destination. The window numbers and screen numbers will be assigned relatively so that the smallest window number among those of the source windows corresponds to the start window number.</p> 

■ How to Display Windows

The method used for calling up a registered window will differ depending on whether the window's type is global or local.

◆ Global Window Display

You can set the "Global Window" area in the [Global Window Setup] from the GP panel's OFFLINE menu or you can use the Global Window dialog box, located in the GP-PRO/PBIII Project Manager screen's [GP Setup]'s [Extended Settings] dialog. Click on the "Global Window" button to bring up this dialog.

Reference *Tag Reference Manual, 2.26 U-tag (Window Display), GP Series Users Manual, 5.3.3 Global Window Setup*

◆ Local Window Display

Here, a U-tag is used on a Base screen to display a window.

Reference *Tag Reference Manual, 2.26 U-tag (Window Display)*

Memo

As you use this Screen Editor Software, file management work such as copying and deleting created screens and projects will become easier, thereby improving your work efficiency. This chapter covers “Information Management of your PRO-PB III data.”

4.1Screen Editing
4.2Project Editing
4.3 Project Compression/Decompression
4.4 Comparing Projects
4.5 Information Display
4.6 Table Editor Character Strings
4.7Symbol Editor
4.8 Device Monitor

4.1 Screen Editing

This section describes the commands used to edit a screen, such as listing screens, and copying/deleting a specified screen.

4.1.1 Listing/Copying/Deleting Screen

You can list the number, size and title of all existing screens for each screen type. You can also print out this screen list.

Reference 9.1 Print Settings

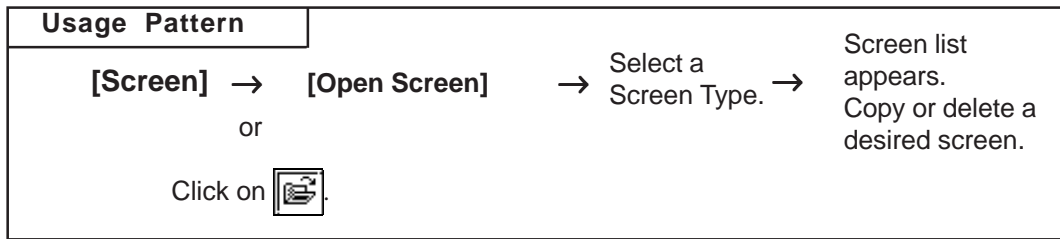

■ Listing Screens

This feature lists screens for the current project.

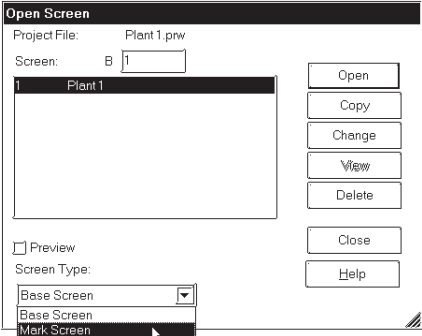
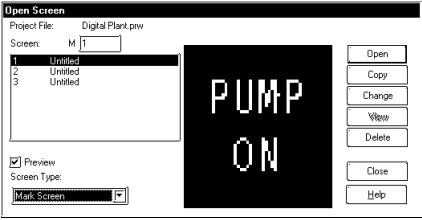
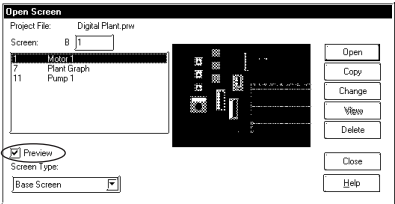
PROCEDURE	REMARKS
<p>(1) Via the Screen Editor, select the [Screen] menu - [Open Screen] command, or click on the  icon.</p> <p>(2) Select the type of screens to be listed. The screens will be automatically listed.</p>  <p>When selecting "Mark Screen" from the Screen Type</p> 	<p>By checking the [Preview] check box, the selected screen image can be viewed in the dialog box.</p>  <p>By changing the [Open Screen] dialog box's size, the screen list display area can be enlarged so that more screens can be displayed.</p> <p>Reference To print the screen list, refer to 9.1.1 ■ Printing-[Project Information] Tab</p>

■ Copying Screens

This feature copies a screen from the current project file.

PROCEDURE	REMARKS
-----------	---------

(1) Via the Screen Editor, select the [Screen] menu - [Open Screen] command, or click on the  icon.

(2) Select a screen to be copied from the list, and click on the  button.

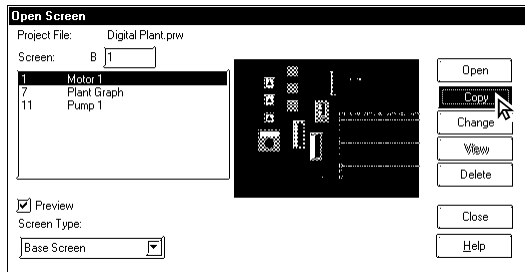

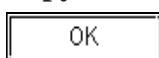
(3) Specify the Start Screen Number of the copy destination and copy count. Then, click on the  button.

The screen will be copied for the designated number, consecutively from the Start Screen No.

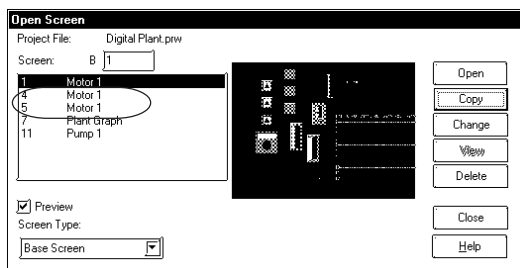
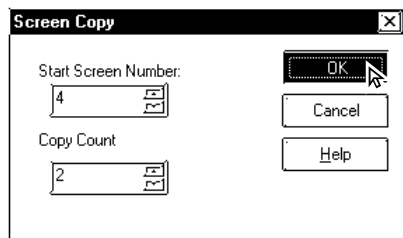

To select several screens simultaneously, drag the mouse down the list, or click on the target screens while pressing your PC's **[Shift]** key or **[Ctrl]** key.





When selecting multiple screens simultaneously, copy will be performed only one time.



Once the [Copy] command is performed, it cannot be undone.

■ Deleting Screens

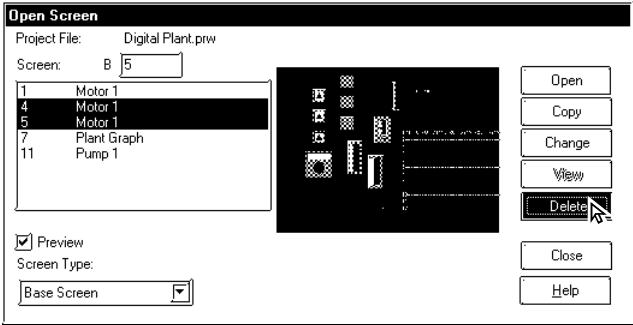
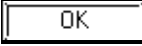
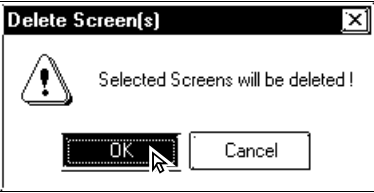
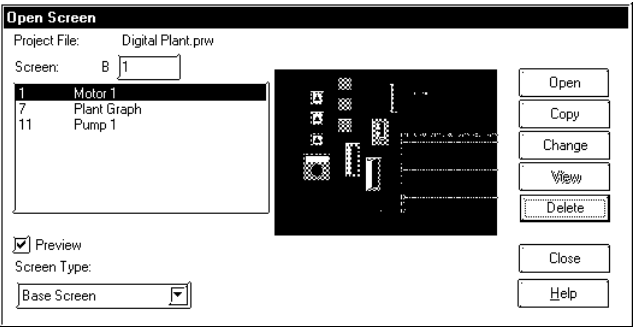
This feature deletes a screen from the current project file.

PROCEDURE	REMARKS
<p>(1) Via the Screen Editor, select the [Screen] menu - [Open Screen] command, or click on the  icon.</p> <p>(2) Select a screen to be deleted from the list, and click on the  button.</p>  <p>(3) Click on the  button to delete the screen.</p>  <p style="text-align: center;">↓</p> 	<p>To select several screens simultaneously, drag the mouse down the list, or click on the target screens while pressing your PC's [Shift] key or [Ctrl] key .</p> <p> Important</p> <p>Once the [Delete] command is performed, it cannot be undone.</p>

■ **Changing Screen Numbers and Titles**

This feature allows you to change screen numbers and titles in the current project file.

PROCEDURE	REMARKS
-----------	---------

[Changing only One Screen]

(1) Via the Screen Editor, select the [Screen] menu - [Open Screen] command, or click on the  icon.

(2) Select a screen to be changed from the list, and click on the  button.

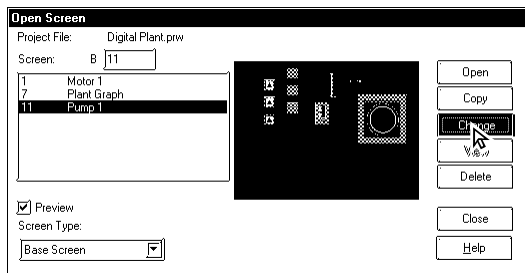

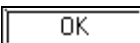

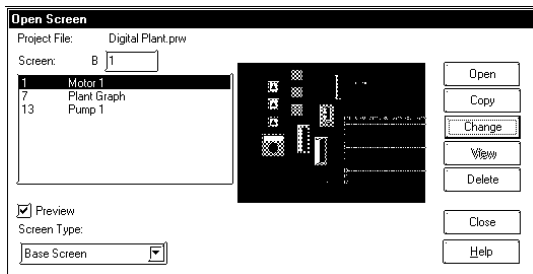
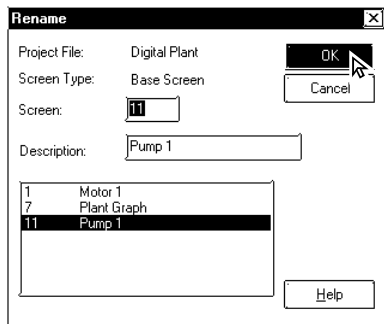
(3) Change the screen number and title, and then click on the  button to delete the screen.

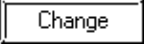
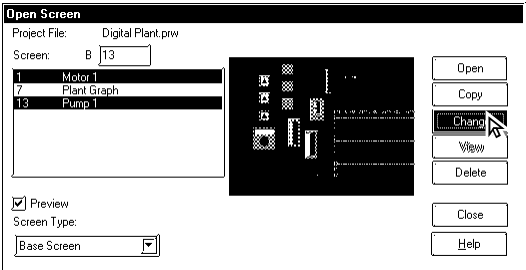
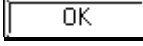
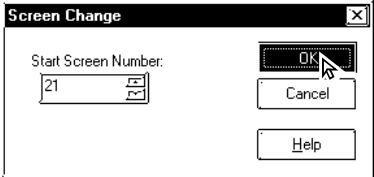
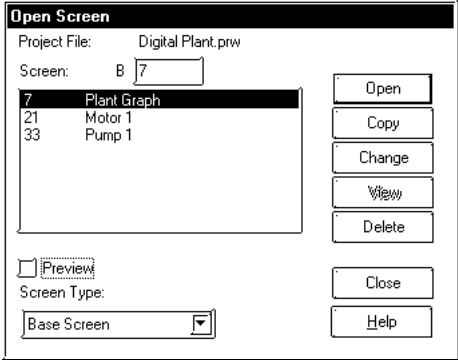

Important
If any existing screen number is specified, it will be overwritten.

The currently open screen cannot be changed.

PROCEDURE	REMARKS
<p>[Changing Multiple Screens at a Time]</p> <p>(1) Via the Screen Editor, select the [Screen] menu - [Open Screen] command, or click on the  icon.</p> <p>(2) Select multiple screens to be changed from the list, and click on the  button.</p>  <p>(3) Specify the start screen number at the destination, and then click on the  button. "21" is specified here. The specified number comes to the top, and the subsequent numbers are changed automatically with increments of offset values.</p>  <p style="text-align: center;">↓</p> 	<p>To select multiple screens at a time, drag the mouse through the desired screens on the list, or click on those screens while holding the  or  key down.</p> <p>The currently open screen cannot be changed.</p> <p>The difference between the start screen number at the destination and that at the source is taken as an offset value. Since the start screen number, 1 is to be changed to 21 here, the offset value is 20. This offset value is added to the subsequent screen number 13, which is then changed to 33.</p>

4.1.2 Copying Screens from Other Projects

Screens created in any project file other than the currently open one, and other settings can be copied to the currently open screen.

■ Specifying Items to Be Copied

After selecting a project file as the copying source, specify the items you want to copy, such as the screen area to be copied and other settings, and a copying method. These screens and settings can also be printed out.

▼ **Reference** ▲ 9.1 Print Settings

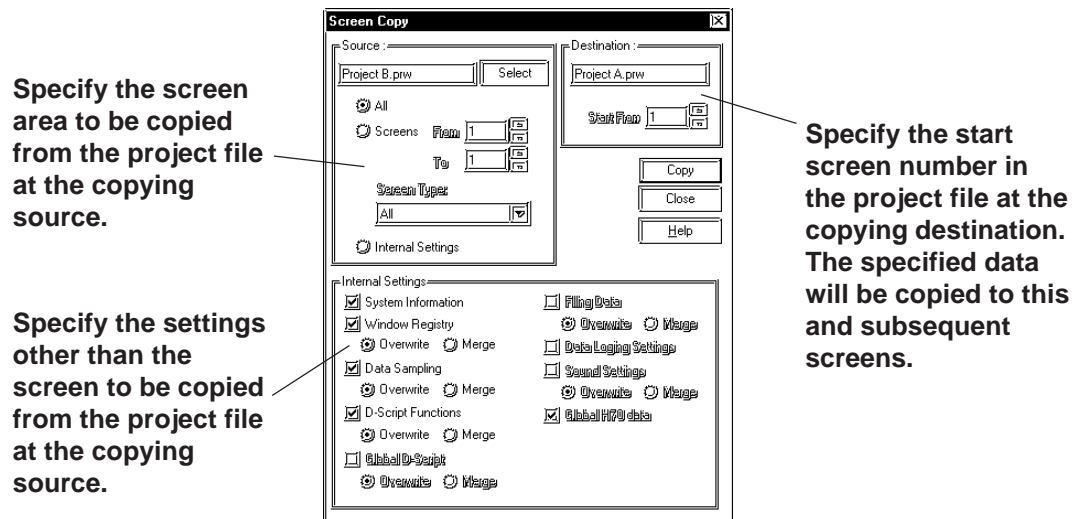

◆ Source

The project file selected as the copying source is displayed. Specify the screen area to be copied and a screen type. If you are not copying a screen, but other settings only, select [Internal Settings].



◆ Destination

The current project file is displayed. When copying a screen from another project file, specify the start screen number in the project file at the copying destination to start copying the screen.

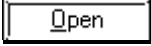
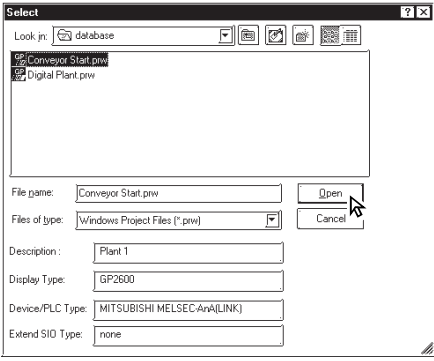
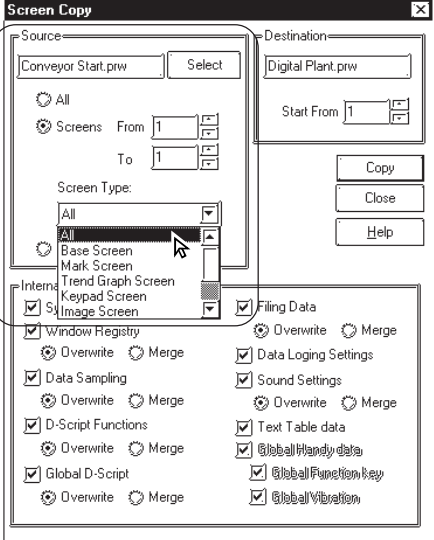

◆ Internal Settings

Select the items to be copied among the global settings for each project file, which are not dependent on any screen. Also specify whether the settings existing in the current project file are deleted by overwriting them or merged (added) with additional settings without deleting them. If "Overwrite" is specified, the settings at the copying destination will be deleted and all the settings at the copying source will be copied. If "Merge" is specified, the settings at the copying source will be copied while those at the copying destination are left as far as possible.

When such a merge is made using [Window Registry], [D-Script Functions], or [Filing Data], you will be prompted to confirm whether any identical existing number or function name is to be overwritten. When the combination is made using [Data Sampling], [Global D-Script], or [Sound Settings], all the settings will be merged.

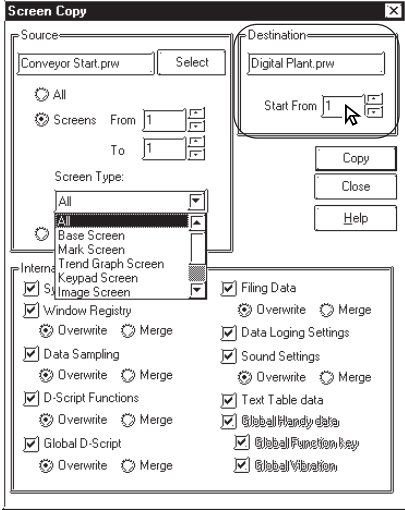
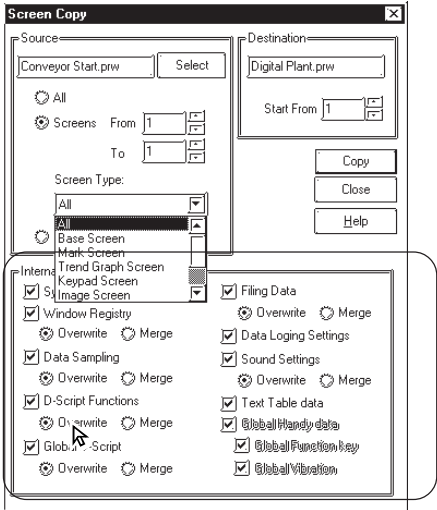
PROCEDURE	REMARKS
<p>First, open the copy designation project.</p> <p>(1) Select the Project Manager's [Utility] menu - [Screen Copy] command.</p> <p>(2) Select the project file to be copied (original project file) from the screen list, or enter the target project name, then click on the  button.</p>  <p>(3) Enter the screen type and screen number of the original screen. Those screens corresponding to the specified initial screen number through the final screen number will be copied.</p> 	<p>To select a screen located in a different folder, you must change to that folder.</p> <p>Reference 1.1.2 ■ Selecting an Existing Project</p> <p>The currently opened project cannot be selected.</p> <p>When you double-click on the project name selected in step (2), you can skip the  command.</p> <p><When [All] is selected> All screens in the Project are copied.</p> <p><Notes on copying windows registered with the Window Screen or Base Screen></p> <p>(1) When copying a window registered with the Window Screen, select [All], or specify the Screen Type as "Window Screen" under the [Screen From/To] option in the [Source] field.</p> <p>(2) When copying a window registered with the Base Screen, check the "Window Registry" option in the "Internal Settings" field.</p> <p><When Windows of the same No. exist in the both the Source and Destination Projects></p> <p>A window registered with the Base Screen cannot be copied onto a window registered with the Window Screen.</p>

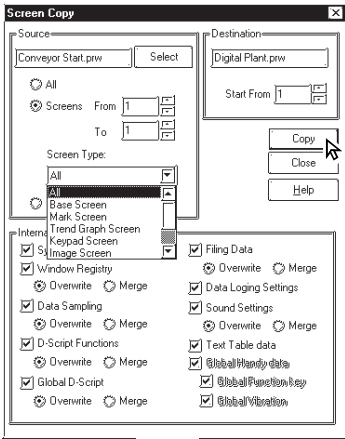
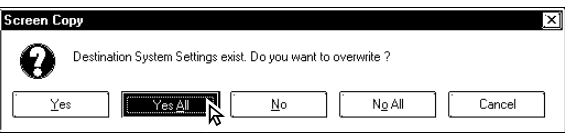

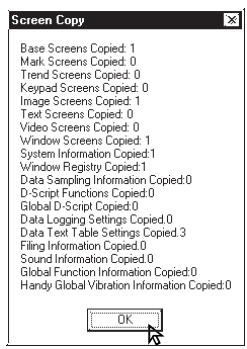
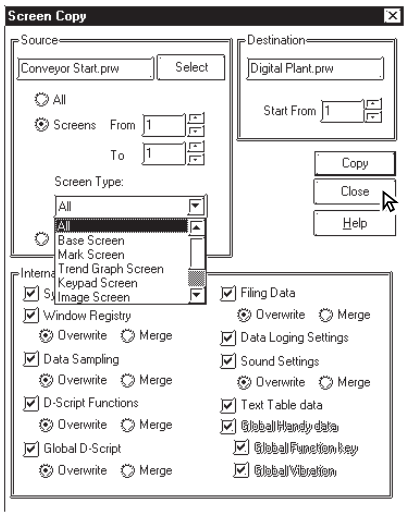
PROCEDURE	REMARKS
<p>(4) Enter the screen type and screen number of the destination screen.</p> <p>The screens will be copied to the Destination project, starting from the specified initial screen number onwards.</p>  <p>(5) Select the internal settings to be copied, and specify the copying method (overwrite or merge).</p>  <p>(6) After confirming your selection and designation, click on the <input type="button" value="Copy"/> button.</p> <p>If there is any screen of an identical number or function name, you will be prompted to conform whether or not to overwrite it. Selecting <input type="button" value="Yes"/> will overwrite such a screen or function name, and selecting <input type="button" value="No"/> will proceed to the next question. If <input type="button" value="Yes All"/> is selected, all the screens or settings will be overwritten. If <input type="button" value="No All"/> is selected, only the screens or settings that do not exist at the copying destination will be copied.</p>	

PROCEDURE	REMARKS
 <p style="text-align: center;">↓</p> 	<div style="text-align: center;">  Important </div> <p>After replacing the screens, you must re-enter all Tag device addresses.</p>
<p>(7) Click on the OK button to exit the screen copy mode.</p> <p>The number of screens copied will be displayed in the dialog box.</p> 	<p>To subsequently copy any other screen in the same project file, repeat the procedures starting with step (3).</p>
<p>(8) Click on the Close button.</p> 	

4.2 Project Editing

4.2.1 Deleting Project Files

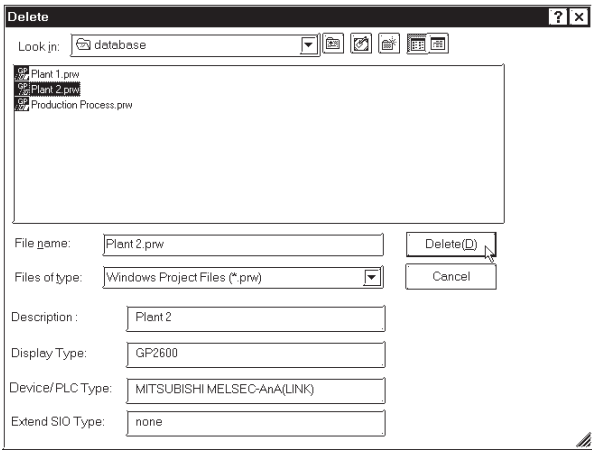
This feature allows you to delete a project file.

PROCEDURE	REMARKS
<p>(1) Via the Project Manager, select the [Project] menu - [Delete] command.</p> <p>(2) Select the project to be deleted from the screen list, or enter the desired project's file name. Then, click on the <input type="button" value="Delete(D)"/> button.</p>  <p>(3) Click on the <input type="button" value="Yes"/> button to delete the project.</p> 	<p>To select a project located in a different folder, change the directory to that folder.</p> <p>Reference 1.1.2 ■ <i>Selecting an Existing Project</i></p> <p>When you double-click on the project name selected in step (3), you can skip the <input type="button" value="Delete(D)"/> command.</p> <p>Important</p> <p>Once the [Delete] command is performed, it cannot be undone.</p>

4.2.2 Rebuilding A Project (Rebuild)

The “Rebuild” tool is used to both check the contents of the PRW files, PRO files, CPW files, CPL files and MRK files created with GP-PRO/PB III for Windows, as well as to rebuild these files if they are damaged.

In the following cases, use the “Rebuild” command to restore file data.

1. Your personal computer is either reset or shut down while you are saving data.
2. The system crashed while you were saving data.
3. Your floppy disk or hard disk is damaged.
4. Your personal computer’s disk drive is defective.
5. A system error (an error not specified in the error message list, such as a partition or checksum error) occurs while a screen is being opened or transferred.
6. The desired project file does not display as a PRW file during project selection, or an existing screen’s number is not displayed when you try to open that screen.
7. You cannot select a project file when you try to perform the [Select Project] command. (i.e. the GP-PRO/PB III for Windows program cannot recognize the project file as a PRW file)
8. When you try to open a file, an error message appears, indicating that the file is damaged.



9. Parts and Tags placed on the GP-PRO/PB III for Windows program screen cannot be displayed on the GP unit, or, a different screen than desired is displayed on the GP unit. (i.e. the relationship between the screen data and Parts data is not correct)

If this error message is displayed, GP-PRO/PB III for Windows program cannot read the target file until this file is rebuilt.

If a file’s data cannot be completely restored with the “Rebuild” tool, the system treats this data as abnormal data and deletes it. In this case, you must edit this PRW file using GP-PRO/PB III for Windows program after the “Rebuild” command is performed.



Note: File Rebuilding requires approximately three times the hard disk space occupied by the Project file.

■ Rebuilding

General description of the “Rebuild” screen is as follows:

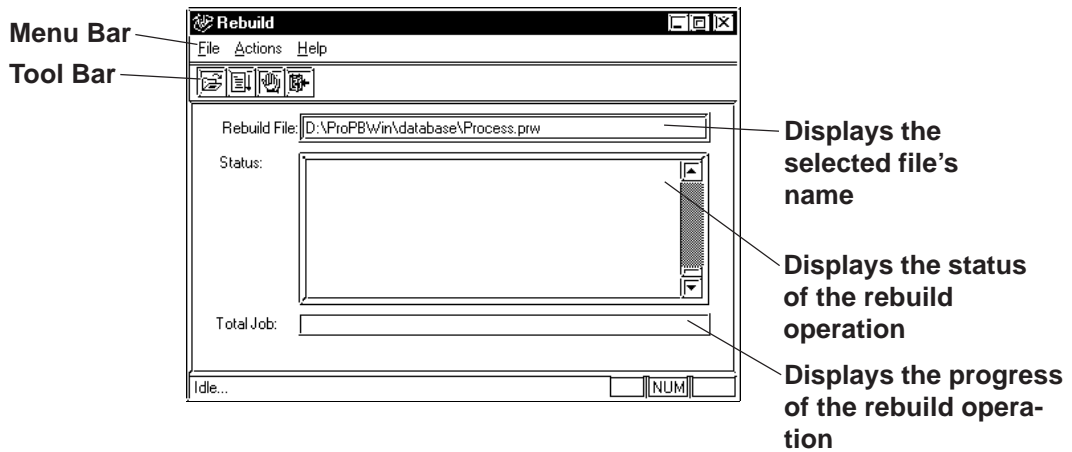

PROCEDURE	REMARKS
-----------	---------

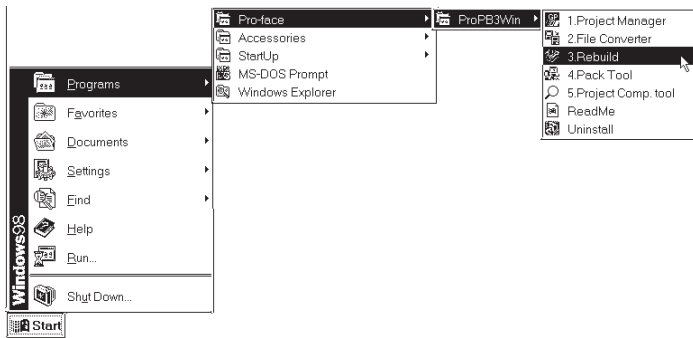

(1) To rebuild a file, click on the Windows main menu’s [Start] button. Point to the [Program] - [Pro-Pace] - [ProPB3Win] menu, and select the [Rebuild] command.

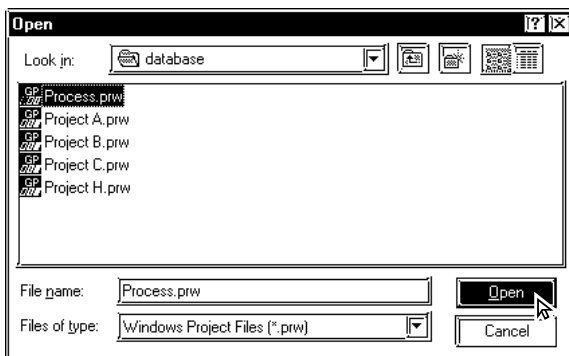

(2) Select the [File] menu - [Open] command, or click on the icon.

(3) Select the file to be rebuilt, or enter the file name. Then, click on the button.

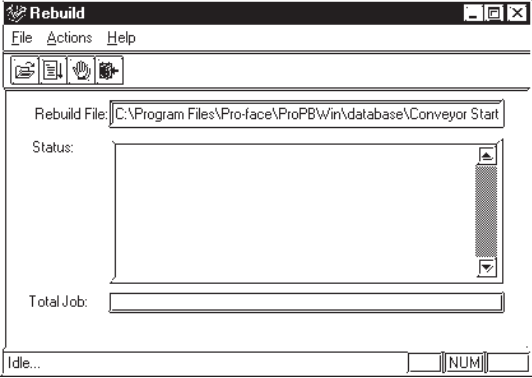
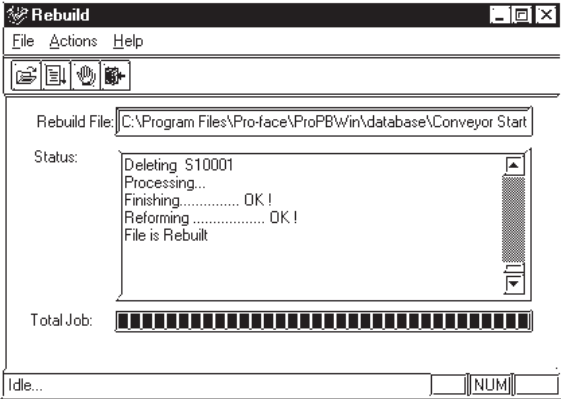

PROCEDURE	REMARKS
<p>(4) After confirming that the file name is correct, select the [Actions] menu - [Start] command, or click on the  icon. The selected file will then be rebuilt.</p>  <p style="text-align: center;">↓</p>  <p>(5) Select the [File] menu - [Exit] command, or click on the  icon and finish the rebuild operation.</p>	<p>To cancel file rebuilding, click on the  icon.</p>



Note: When parts and tags placed on the GP-PRO/PB III screen are not displayed on the GP screen or are displayed in completely different shapes (the parts data is not properly associated with the screen data), execute the Rebuild command and transfer the data again. Select  and choose the [Transfer Settings] command from the [Setup] menu to display the [Transfer Settings] dialog box. Specify the [Send All Screens] option from the [Transfer Method] field.

4.2.3 Converting Addresses and Device Codes

This feature allows you to change a Tag's addresses. This address conversion can be performed on either word or bit addresses. This command is useful for changing both addresses or an address's device code.

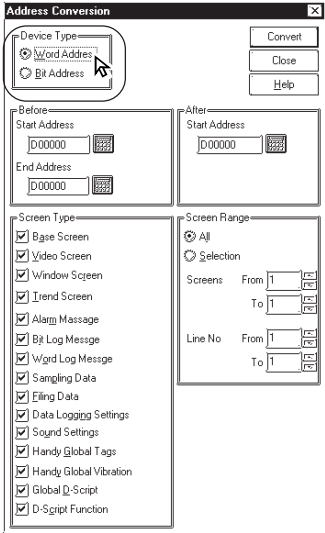
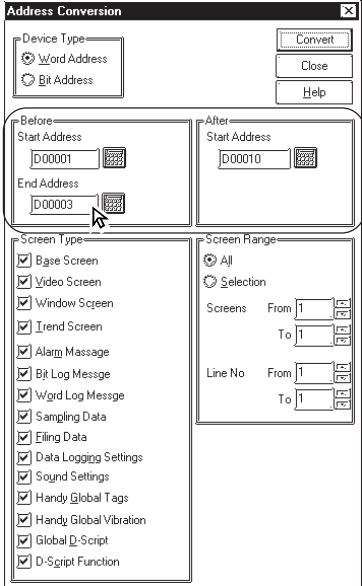
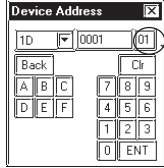
PROCEDURE	REMARKS
<p>(1) Via the Project Manager, select the [Utility] menu - [Convert Addresses] command.</p> <p>(2) Select the type of the address conversion to perform: Word Address or Bit Address.</p> 	<p>In word address conversion mode, Tag addresses specified by a bit address can also be changed, within a specified range.</p> <p>When using any of the following PLCs, specify the PLC number, as well: FACTORY ACE, 1:n communication (Yokogawa Electric Corp.) TOYOPUC-PC2, 1:n communication (Toyota Machine Works) TOYOPUC-PC3J, 1:n communication (Toyota Machine Works) CP9200SH Series (Yasukawa Electric Corp.) SDC Series (Yamatate Electric Corp.) THERMAC NEO series (OMRON)</p>
<p>(3) Enter the address conversion range and the updated initial address.</p> <p>Before this step is performed, be sure that the first and last device codes used are the same. You cannot specify an address conversion range for a different device.</p> 	 <p>To convert the addresses of tags assigned to the global functions keys for the GP-H70/GP2000H at a time, previously select the [Handy Global Tag] option from the [Screen Type] menu beforehand.</p> <p>When converting addresses, be sure that the address settings meet the following condition: “Final address before conversion” - “Initial address before conversion” ≤ “Final address after conversion” - “Initial address after conversion”</p> <p>If the left side is larger than the right side in the above formula, the Tags corresponding to the surplus addresses will be assigned to the final address of the same device.</p>

PROCEDURE	REMARKS
-----------	---------

(4) Select the type of screen to be replaced.

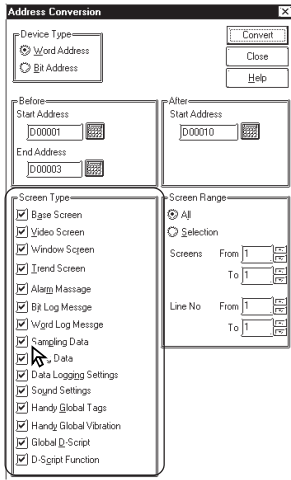

(5) Enter the screen number to be changed. (Enter the line numbers used in the Alarm Editor)

All the addresses between the initial screen number and the final screen number (or the addresses between the initial line number and the final line number), will now be changed.

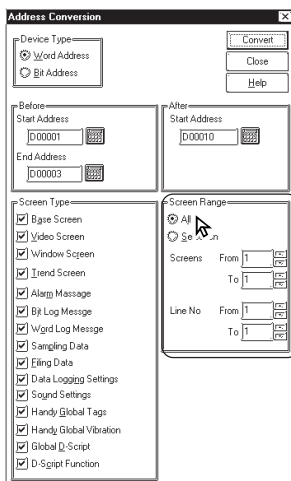

(6) After confirming that all the settings are correct, click on the Convert button.

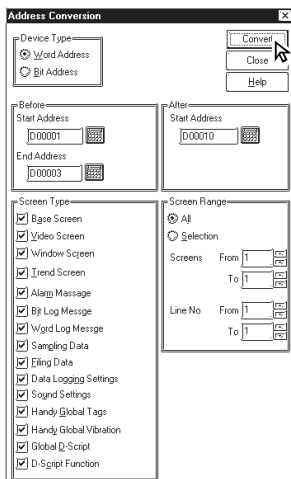

Do not convert addresses on 2,000 screens or more at a time. Otherwise, the memory capacity might run short after this conversion. If this memory shortage occurs, re-start the GP-PRO/PB III.

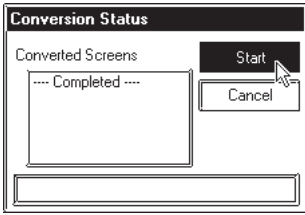
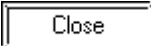
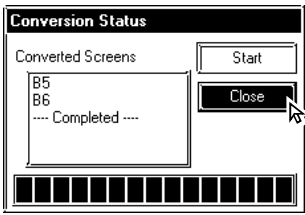
PROCEDURE	REMARKS
<p>(7) Click on the  button. The progress of the address conversion will be displayed.</p> 	
<p>(8) To stop the address conversion prior to normal completion, click on the  button.</p> 	

4.2.4 Convert Load Screens

This feature allows you to convert the currently loaded screens to different ones via the [Load Screen] command, all at once.

■ Load Screen and Search Screen Settings

Here, specify the screens to be converted. Enter the numbers of the Search Screens on which Load Screens have been called up and called up Load Screens.

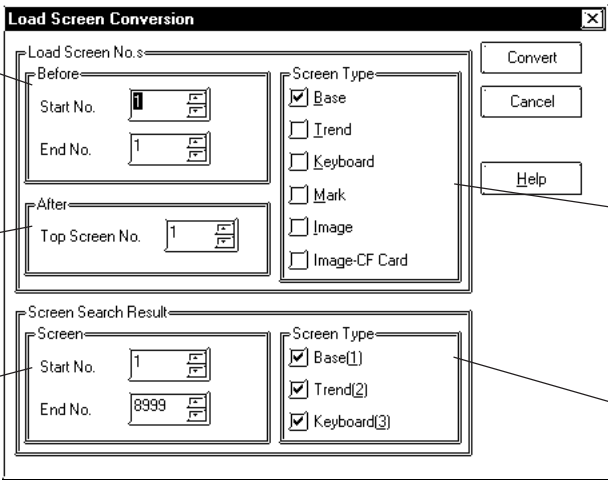

Specify the range of Load Screens before conversion. (Annotation pointing to 'Before' section)

Specify the Top Screen number of the Load screens after conversion. (Annotation pointing to 'After' section)

Specify the range of the Search Screens on which Load Screens have been called up. (Annotation pointing to 'Screen Search Result' section)

Specify the Load Screen Type. (Annotation pointing to 'Screen Type' list in the 'Before' section)

Specify the Search Screen Type. (Annotation pointing to 'Screen Type' list in the 'Screen Search Result' section)

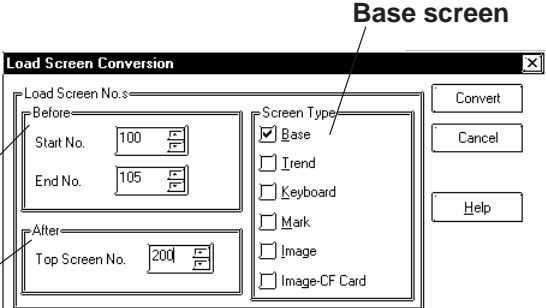
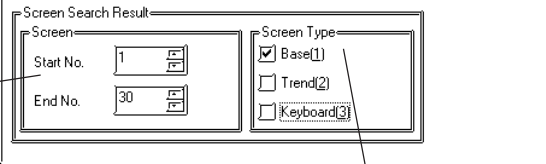
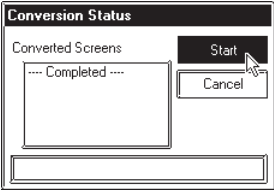
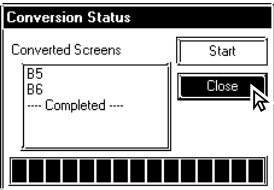



PROCEDURE	REMARKS
<p>Example; Load Screens B100 to B105 currently loaded on Base screens B1 to B30 are converted to B200 to B205.</p> <p>(1) Via the Project Manager, select the [Utility] menu - [Convert Load Screens] command.</p> <p>(2) Specify the type and numbers of the Load Screens to be converted and the Top Screen number of the Load Screens after conversion.</p>  <p>(3) Specify the range of the Search Screens and their type.</p> <p>The Load Screen numbers specified in step (2) will be converted and called up on Search Screens specified by the Start and End numbers, here.</p>  <p>(4) After confirming all the settings are correct, click on the Convert button.</p> <p>(5) Click on the Start button to start conversion. The conversion status will continuously be displayed.</p>  <p>(6) Click on the Close button to close the dialog.</p> 	

4.2.5 Changing a Project's GP Type

You can change the GP type of your current project.

Note: After changing the GP type, you can save the current project using the [Project] menu - [Save As] command.

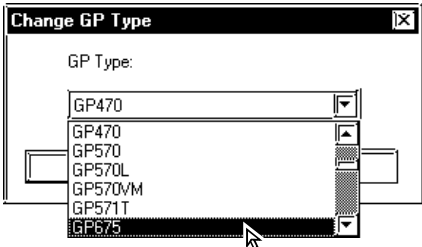
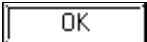
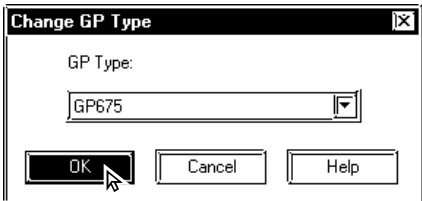
Reference 1.1.2 ■ Saving a Project Under a Different Name

PROCEDURE	REMARKS
<p>(1) Via the Project Manager, click on the  icon, or select the [Project] menu - [Change GP Type] command.</p>  <p>(2) To change the GP type, click on the desired GP type.</p>  <p>(3) Click on the  button.</p> 	<p>Do not open screens other than the Project Manager. Doing so will disable the selection of the GP Type.</p> <p> Important</p> <p><i>The drawing area, commands and memory used by this change will vary depending on the selected GP type. Be sure to check these items before changing the GP type to be sure that your change(s) will be compatible with your existing project's data.</i></p>



- When a vertical type GP unit is replaced with a horizontal type or vice-versa, the displayed screen is rotated 90°. Therefore, you must also edit the screen using the [Rotate] command. After editing, be sure to check that the displayed data is as desired.

Example)

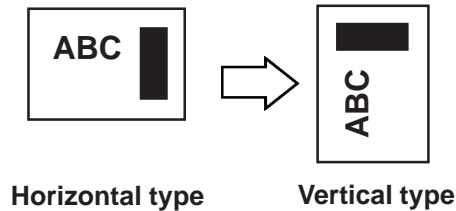



- When a high-resolution type GP unit is replaced with a low-resolution type, data beyond the display range cannot be displayed. If a project file is changed to a low-resolution type and then changed back to the high-resolution type again, data beyond the display range (data that cannot be displayed with the low-resolution type GP panel) will be restored.
- The maximum number of characters used for an alarm summary differs according to the GP unit screen's resolution. For example, if an alarm message is created for a high-resolution type GP and then changed for the low-resolution type, data beyond the message area cannot be displayed.

4.2.6 Changing Your Project's Device/PLC Type

You can change the Device/PLC type selected in the current project.

Note: After changing the Device/PLC type, you can save the current project using [Project] menu - [Save As] command.

Reference 1.1.2 ■ Saving a Project Under a Different Name

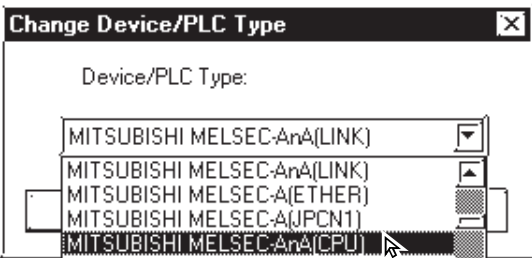
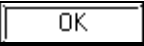
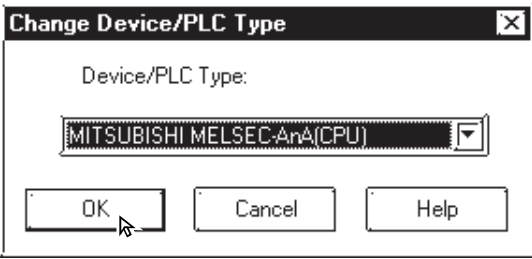
PROCEDURE	REMARKS
<p>(1) Via the Project Manager, click on the  icon, or select the [Project] menu - [Change Device/PLC Type] command.</p>  <p>(2) To change the Device/PLC type, click on the desired GP type and then.</p>  <p>(3) Click on the  button.</p> 	<p>Do not open screens other than the Project Manager. Doing so will disable the selection of the Device/PLC Type.</p> <p>Once you change a project's Device/PLC type, you must re-enter that project's device addresses for Tags, D-script and alarms. Save each screen separately again when the Function Switch set up with the "Change Screen" function is used on the screen.</p>

4.2.7 Changing Extend SIO Type

You can change the Extend SIO Type selected in the current project.

Reference 1.1.2 ■ *Creating a New Project*

This feature is available only with the GP-2000 Series (except the GP-2301 and GP-2501).

Note: After changing the Extend SIO Type, you can save the current project using [Project] menu - [Save As] command.

Reference 1.1.2 ■ *Saving a Project File under a Different Name*

PROCEDURE	REMARKS
-----------	---------

(1) Via the Project Manager, click on the  icon, or select the [Project] menu - [Change Extend SIO Type] command.



(2) To change the Extend SIO Type, click on the desired Extend SIO type and then.

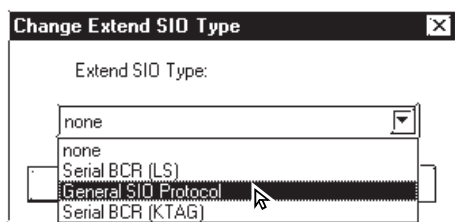

(3) Click on the  button.

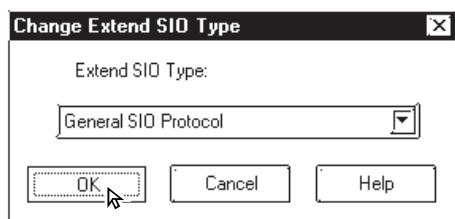



Important

Do not open screens other than the Project Manager. Doing so will disable the selection of the Extend SIO Type.

4.3 Project Compression/Decompression

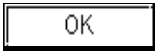
Compressing a project file reduces the size of its data to accommodate a standard floppy disk's limited capacity. A compressed project file and its screens however, cannot be edited. To edit the screens, you must first decompress the project file.

Usage Pattern	
Start → PROPB3Win → Pack Tool →	
[Action] → [Compress Project File]/ [Decompress Project File]	Designate a Project file to be compressed or decompressed. → Click on the  button.
or	
Click on  or  .	

A general description of the compression tool is as follows:

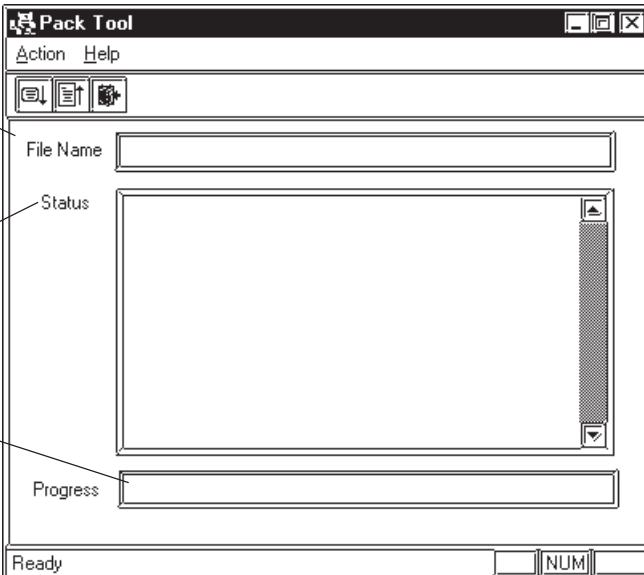

The screenshot shows the 'Pack Tool' window with the following components and callouts:

- File Name:** A text input field for the project file name.
- Status:** A large text area for displaying the status of the project file compression/decompression.
- Progress:** A progress bar at the bottom of the window.
- Buttons:** Three icons in the top-left corner for file selection and actions, and an 'OK' button at the bottom-right.
- System Elements:** A menu bar with 'Action' and 'Help', a status bar with 'Ready', and a numeric keypad area with 'NUM'.

4.3.1 Compressing a Project File

A Project file can be compressed to a smaller size. At this time, a large sized file can be divided into smaller files automatically according to the specified capacity. After a project file is divided into several files during compression, serial numbers are assigned to the first character of each file extension (or assigned to the first and second characters if the file number has two digits).

Example) *.0PW, *.1PW...*.9PW, *.10W, *.11W

Enter the file name of the project file to be compressed, or select a desired file name from the list by clicking on the [Browse] button

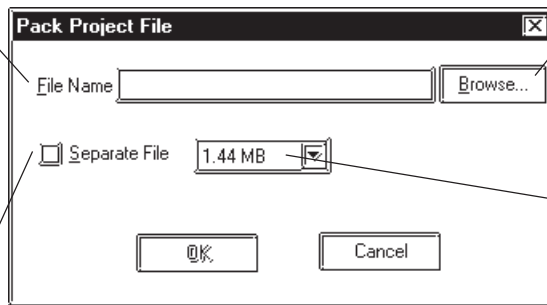

The compressed project file is automatically divided into several files according to the specified file size



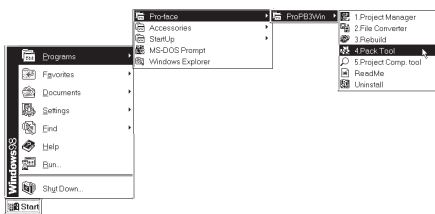
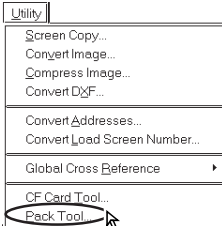
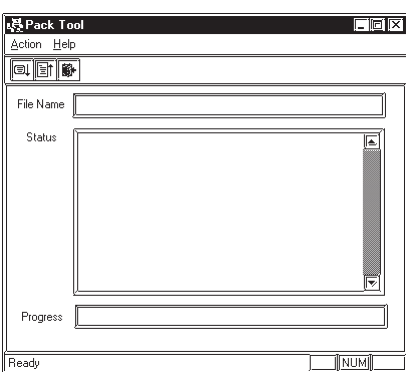

Used to locate the project file to be compressed

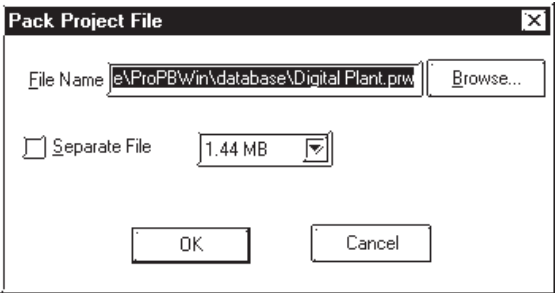
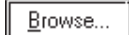
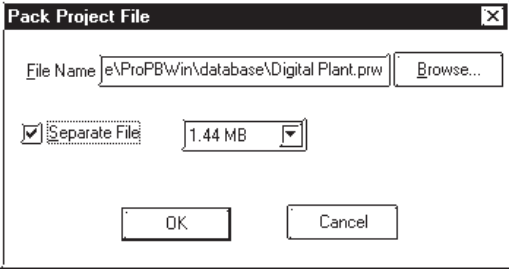
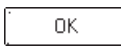
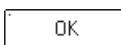
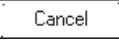
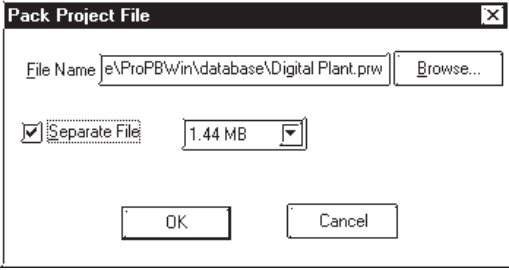
Used to select the file size limit

PROCEDURE	REMARKS
<p>(1) First, click the Windows [Start] button. Then, click on the [Programs] - [Pro-face] - [ProPB3Win] menu and click the [4. Pack Tool] menu item. You can also select [Pack Tool...] from the PRO-PB Utility pull-down menu.</p> <p>From Windows Main Menu</p>  <p>From GP-PRO Program Manager Utility Menu</p>  <p style="text-align: center;">↓</p> 	

PROCEDURE	REMARKS
<p>(2) Select the [Action] menu - [Compress Project File] command, or click on the  icon.</p> <p>(3) Select the folder and project file to be compressed, or enter the file name. The file name of the desired project file will be displayed in the “Pack” screen.</p> 	<p>To call up a menu of all the available folders, click on the  button.</p>
<p>(4) To divide the project file during compression, click on the [Separate File] check box, and select the desired file size limit.</p> 	
<p>(5) Click on the  button.</p> <p>If the same file name already exists, the system asks if the existing file must be overwritten. If you select , the existing file will be overwritten. If you select , the existing file will not be overwritten, and you will return to the previous dialog box.</p>  <p style="text-align: center;"></p>	<p>The compressed project file will be stored in the same folder as the original project file.</p>

PROCEDURE	REMARKS
<p data-bbox="217 264 756 367"></p> <p data-bbox="165 454 912 544">(6) Select the [Action] menu - [Exit] command, or click on the  icon.</p>	

4.3.2 Decompressing a Project File





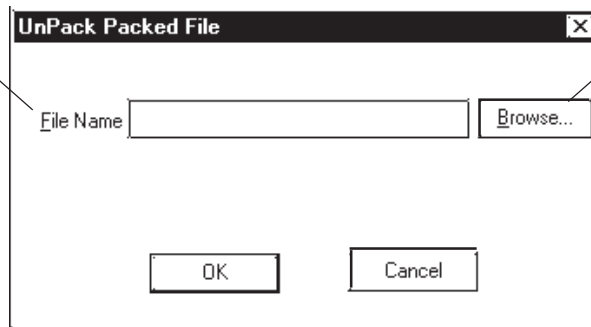

A compressed project file (OPW file) cannot be edited. To edit the compressed project file, you must first decompress it.

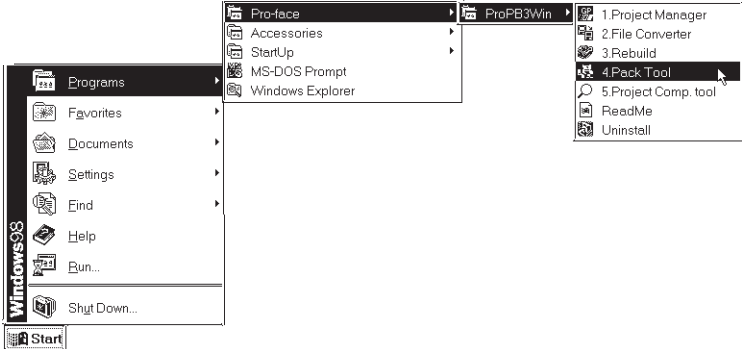
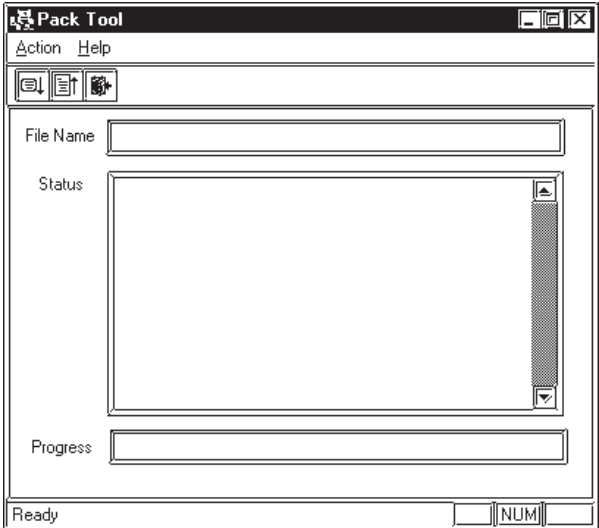
Enter the file name of the project file to be decompressed, or select the desired file name from the list by clicking on the [Browse] button

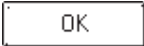

Used to locate the project file to be decompressed

PROCEDURE	REMARKS
<p>(1) Click on the Windows desktop's [Start] button. Then, point to the [Programs] - [Pro-face] - [ProPB3win] menu and click on the [4. Pack Tool] menu.</p>  <p style="text-align: center;">↓</p> 	

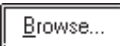
PROCEDURE	REMARKS
<p>(2) Select the [Action] menu-[Decompress Project File] command, or click on the  icon.</p> <p>(3) Select a folder and Project file to be decompressed or enter the file name, and click on the  button.</p> <p>If the same file name already exists, the system asks if the existing file must be overwritten. If you select , the existing file will be overwritten. If you select , the existing file will not be overwritten, and you will return to the previous dialog box.</p> <div data-bbox="264 734 746 999" style="border: 1px solid black; padding: 5px; margin: 10px 0;"> <p>UnPack Packed File</p> <p>File Name: <input type="text" value="Digital Plant.Opw"/> <input type="button" value="Browse..."/></p> <p><input type="button" value="OK"/> <input type="button" value="Cancel"/></p> </div> <div style="text-align: center; margin: 10px 0;">  </div> <div data-bbox="264 1111 879 1301" style="border: 1px solid black; padding: 5px; margin: 10px 0;"> <p>PBWPack</p> <p> File 'Display Data.PR'W' already exists. Okay to overwrite this file?</p> <p><input type="button" value="OK"/> <input type="button" value="Cancel"/></p> </div> <p>(4) Select the [Action] menu - [Exit] command, or click on the  icon.</p>	<p>To select a folder, click on the  button.</p> <p>To decompress a compressed project file that has been divided into several files, make sure that all divided files are available. However, when you specify the file name to be decompressed, the system displays the first file name (*.OPW) only.</p> <p>The decompressed project file will be stored in the same folder as the compressed file.</p>

4.4 Comparing Projects

Data can be compared between two project files.

The overview of the Project Comparison Tool is shown below:

Enter project file names to be compared with each other, or select those file names from the list by clicking on [Browse] button.

Select project files to be compared with each other.





Displays the comparison result.

Output the comparison result as a text data file.

Displays only differences in the comparison result.

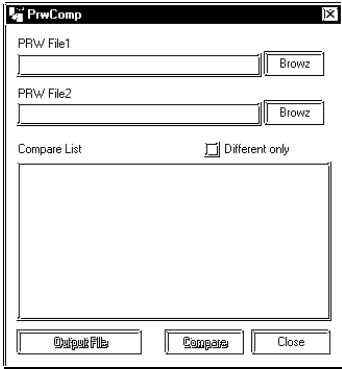
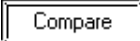
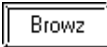
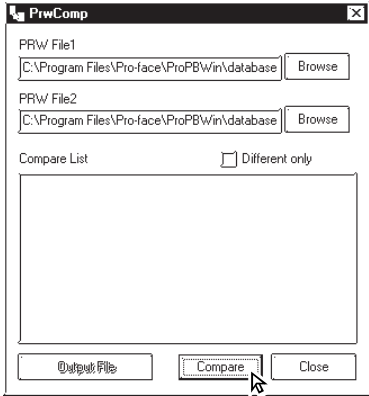
Usage Pattern	
[Start] → [ProPB3Win] → [5. Project Compare]	→ Specify project files to be compared with each other → Click on the [Compare] button

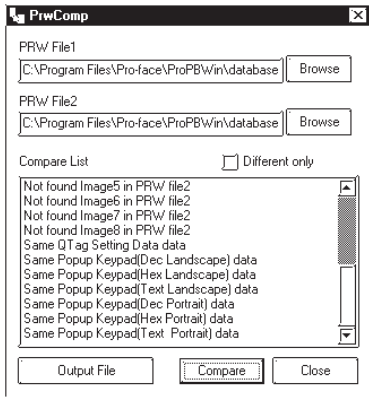
PROCEDURE	REMARKS
<p>(1) Click on the [Start] button. Move the mouse pointer to [Program], [Pro-face] and then [ProPB3Win]. Click on [5. Project Compare].</p>	

PROCEDURE	REMARKS
 	
<p>(2) Select a Project file to be compared or enter the file name, and click on the  button.</p>	<p>Specify folders → </p>
	
	<p>Checking the [Different only] check box will enable you to toggle between displaying only differences in the comparison result and displaying all the details of the comparison result.</p>
	
	<p>Clicking on the [Output File] button will enable you to output the comparison result as a text file (*.txt).</p>
<p>(3) Select the [Action] menu - [Exit] command, or click on the  icon.</p>	

4.5 Information Display

This section describes the types of screen and project information available.

4.5.1 Project Information

[Project Information] displays both the commands used to edit the current project, and the date and time of its last revision. To use this command, select the [Project] menu - [Properties] command.

■ Project

◆ Current Project

Displays the file name of the currently selected project file.

◆ Description

Displays a comment about the current project.

◆ Device/PLC Type

Displays the Device/PLC type selected in the currently opened project file.

◆ GP Type

Displays the GP type selected in the current project file.

◆ Extend SIO Type

Displays the current Extend SIO setting. This setting can be changed when a GP2000 series unit is selected as the GP Type. The setting is grayed out when any other type of GP is selected. (Except the GP-2301 and GP-2501)

◆ Project Size

Displays the data volume of the current project file.

If any Parts are placed in this file, the file volume will be increased.

◆ Date & Time

Displays the date and time when this file was saved last.

◆ Size of Screen To Be Sent To GP

Displays the total data volume that will be occupied in the GP unit panel, relative to the current project file. This item indicates the case where upload information is sent to the GP panel, and the case where upload information is not sent to the GP unit, separately.

The ratio of the current total data volume to the GP unit's total memory capacity is displayed in %. Referring to the GP unit's total memory capacity, you can calculate the approximate number of screens that can be accepted by the GP panel.

When the data volume is indicated as “????”, select the [Project]’s - [Transfer] menu, and then select the [Prepare] command.

Reference 7.2.4 Transfer Preparation



Note: The size of the CF card data to be transferred is not displayed.

◆ **Extended Screen Count**

Displays the number of screens that will be created in the GP unit, relative to the current project file. Since this value includes the GP unit’s internal screens, it is larger than the number of screens that have been created with GP-PRO/PB III for Windows 95. To display this information, set up the current project file in the “Transfer Preparation” mode. If the project file is not in the “Transfer Preparation” mode, the number of screens is indicated as “????”



Note: The number of screens transferred to the CF card is not be displayed.

◆ **Device Monitor Information**

Displays whether the device monitor command has been registered or not.

■ **Screen**

This screen shows the number of screen types, alarm messages and channels contained in the current project.

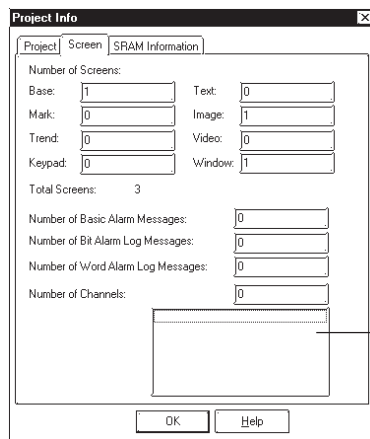

The number of channels and the screen number that are used in the project are displayed

■ **SRAM Information**

The situation with the use of the backup SRAM in the current project is displayed on a function basis.

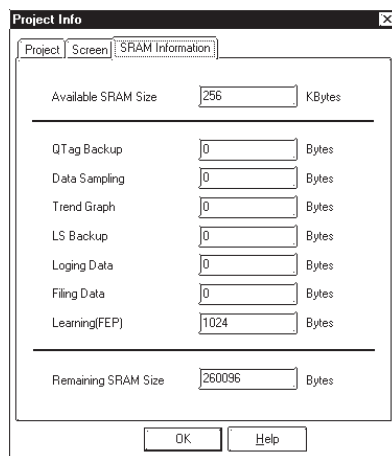

Note: If Filing Data is saved on both the GP's internal memory and the CF card, the available capacity of the CF card will be displayed.

4.5.2 Screen Information

The [Screen Information] screen displays the settings for the currently open screen, as well as the date and time of its last revision. To use this command, select the [Project] menu's - [Screen Information] command.

■ Screen

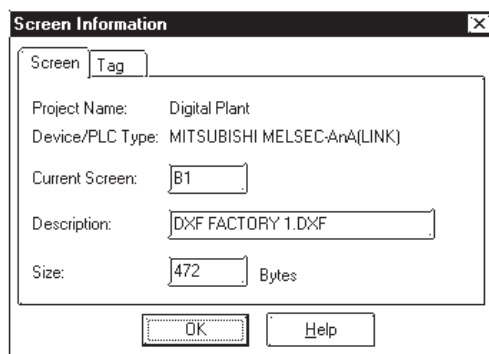

◆ Project Name

Displays the file name of the currently selected project file.

◆ Device/PLC Type

Displays the Device/PLC type selected in the current project file.

◆ Current Screen

Displays the screen type and screen number of the current screen.

◆ Description

Displays the title of the current screen.

◆ Size

Displays the data volume of the current screen. If any Parts are placed on this screen, the screen data volume will be increased.

■ Tag

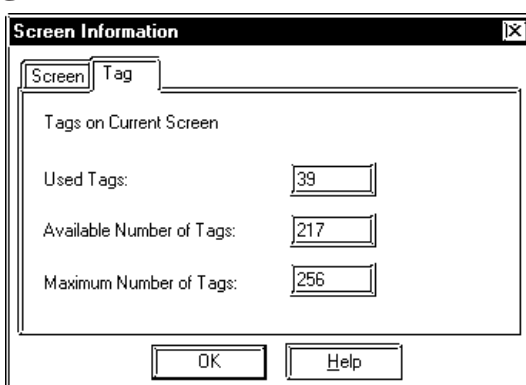

◆ Used Tags

Displays the number of Tags specified on the current screen.

◆ Available Number of Tags

Displays the acceptable number of Tags after subtracting the number of Tags specified on the current screen from the allowable maximum number of Tags.

◆ **Maximum Number of Tags**

Displays the maximum number of Tags available on the current screen. The allowable maximum number of Tags varies depending on the selected GP type.

GP-270, GP-370, GP-H70	128 Tags
GP-470, GP-570, GP-571, GP-675, GP-870	256 Tags
GP-377, GP-77R, GP2000 series	384 Tags

4.5.3 Version Information

[Version Information] displays the GP-PRO/PB III Project Manager and Editor's version information. To see this data, select the [Help] menu - [About] command.

<Project Manager Version Information>



4.6 Table Editor Character Strings

The Character Strings Settings and the Multi-language Display Feature are described in this section.



important

- **Multi-language Display Feature is supported by GP-377/77R/2000 series units.**
- **Bit map fonts cannot be used in the table editor character strings.**

4.6.1 Overview: Multi-language Display Feature

Using Index Text for the text objects and part's labels allow you to easily switch the language and information displayed on the screen during operation (the diagram below describes the steps for switching the display language.) Switching between tables is performed with the Control Address (two or more tables cannot be specified at one time). Thus, you can easily switch the display language or displayed text items on the screen. Character strings are switched by selecting tables (a group of character strings). Registration of the Index Text and setting the Control Address can be performed with the Text Table Editor.

Example: Switching the display language for the label of a part

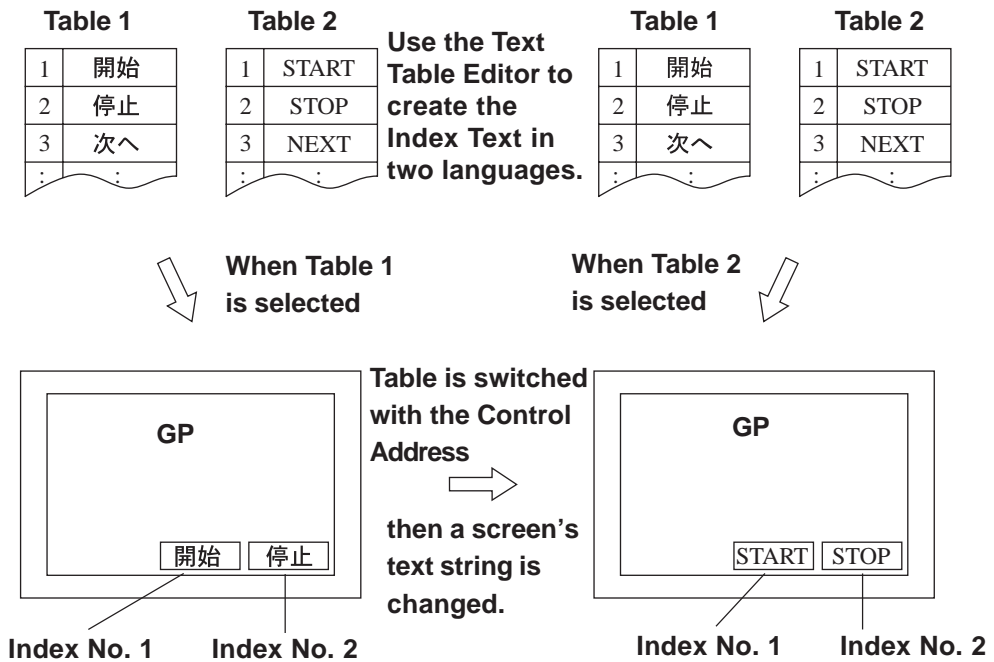



- **Switching tables uses the same process as switching screens. Therefore, some screen displays drawn with tags may not be able to be refreshed.**
- **The following character strings cannot be changed even when the tables are switched.**
 - [A-tag] character strings
 - [K-tag] character strings
 - [S-tag] character strings
 - [P-tag] format character strings
 - [X-tag] character strings
 - Filing Feature
 - Logging Feature
 - Message Display

◆ **Precautions for switching tables with the Alarm function**

- When a table is switched while an alarm message (Flow display) is displayed, the switched table is not used until the next message is issued.

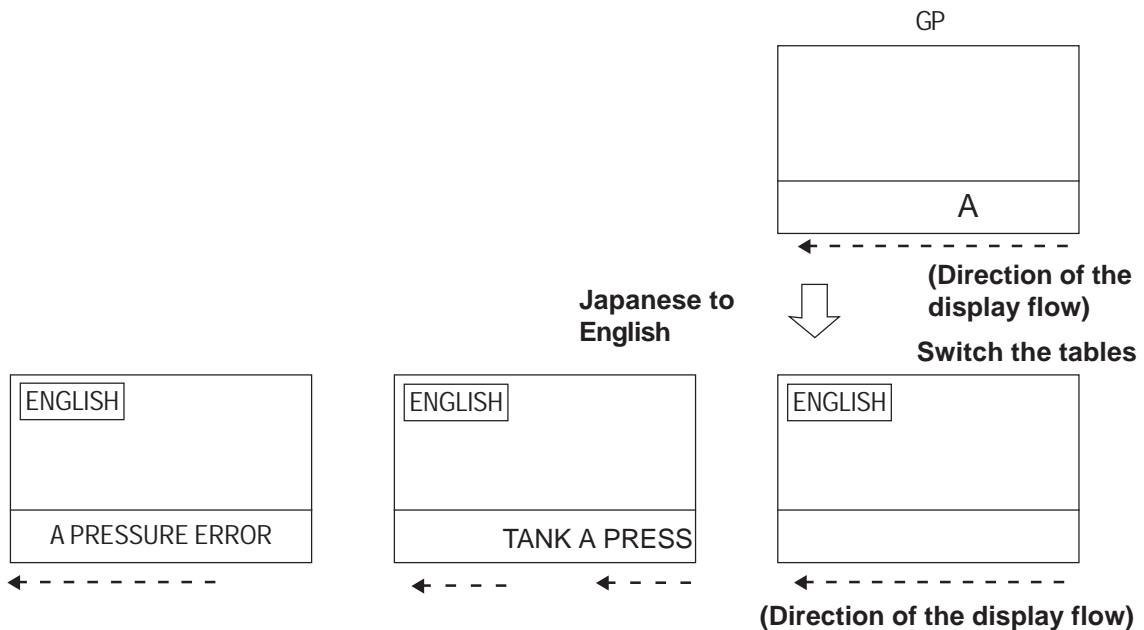

- When the print setting is enabled for the Alarm Message Function (Flow display), the alarm message of the table (language) displayed at the moment when the alarm is triggered or reset will print.
- When a table is switched while real-time printing is set to print the alarm summary (a-tag) or log alarms (Q-tags), the switched table will be used starting from the next print job.



- When a table is switched while log alarms (Q-tags) are being written into the CF Card as a CSV file, the switched table is used immediately.
- The steps for switching tables are similar to those for switching screens. Therefore, the Sub Display, Cursor Display and Scroll Display that were displayed before the switching with the Log Alarm (Q-tag) will not be reproduced.

4.6.2 Table Editor Index Character Strings

The Table Editor is used to create a table's index character strings.

Table Editor Index Character Strings can be exported in CSV format. You can also import a CSV file to use as an index character string.

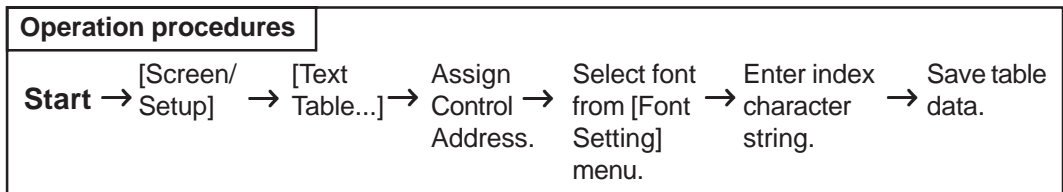

■ Table Editor Features

The screenshot shows the 'Text Table Editor - Plant 1.prw' window. It includes a menu bar (File, Edit, View, Help), a toolbar, a control address field (D00000), a 'Jumps to the designated line' field (1), a table selection dropdown (1: Table1), and font settings (GP Font Setting, ASCII (Code Page 850)). The main area is a table with columns 'Cha...', 'Lines', and 'Message'. The table has 19 rows, each with an index number (1-19) and '100' in the 'Lines' column. The 'Message' column is empty. A status bar at the bottom shows 'Ready' and a numeric keypad icon.

Click here to specify the Control Address (points to the D00000 field)

After setting up the text, specify the line and click the [Go to] button to jump to the specified line. (points to the 'Jumps to the designated line' field)

Select a table to enter character strings. Up to 16 tables can be registered (points to the table selection dropdown)

Set the font (language) for the selected table (points to the font settings area)

Index No. Up to 3,000 character strings can be registered (points to the index numbers in the table)

Double-click on this area to call up a message dialog box (Up to 1,200 characters) (points to the 'Message' column in the table)

■ Entering ControlAddress Settings

Specify the Control Address to switch the tables.

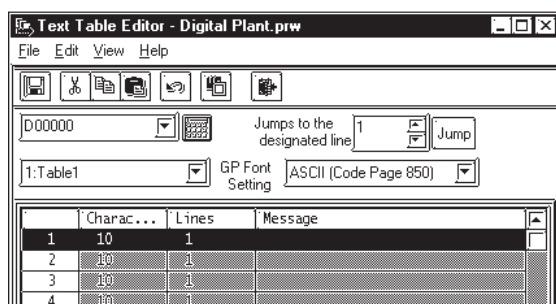

In the Control Address, store the Table No. you want to display.

The default text table is displayed when "0" is stored. To set up the default text table, select [Default Table Setup] from the [File] menu on the "Text Table Editor" dialog screen.

<Values stored in the Word Address>

Value in one Control Address	Table No.
0	Initial character string table
1	Table 1
2	Table 2
:	:
16	Table 16



Note:

- A table will not appear when you specify a table number for which nothing is set.

■ Table Name

Up to 16 tables can be registered.

To change a table name, display the table whose name is to be changed onto the "Text Table Editor" screen. Next, click [Table Name Change] on the [File] menu.

Enter the desired table name and click the [OK] button to change the table name.

■ GP Font Settings

Specify one font (language) for each table (a table cannot contain more than one font [language]).

■ Entering Messages

On the Text Table Editor, double-click the column of the Index No. you want to set up. The screen below appears on the screen. Enter the Index Text for each Index Number.

Specify the message size [Characters] x [Lines] for each Index No.

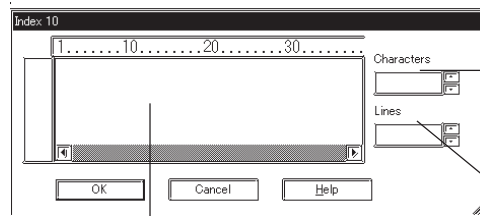

Specify the number of characters in a line. (1 to 100 single-byte characters)

Specify the number of lines. (1 to 40 lines)

Character Entry Area



Note: • The number of characters used in the index character string is determined by [Characters] x [Lines]. (Max. 1,200)

$$[\text{Characters}] \times [\text{Lines}] \leq 1,200$$

- Multiple display lines can be used for [Character string] and Parts [Label] only. For other features, do not specify an index number for which multiple display lines are set. If such an index number is specified, only the first line will be displayed.





Important

The index characters for each index number [Characters] x [Lines] are available in all tables.

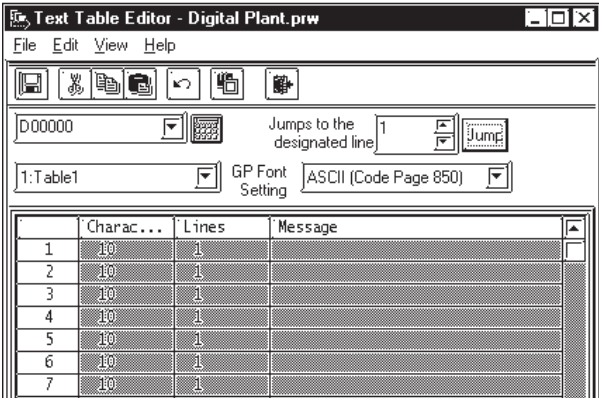
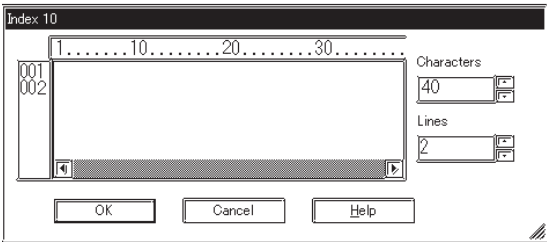
■ Index Character String Registration

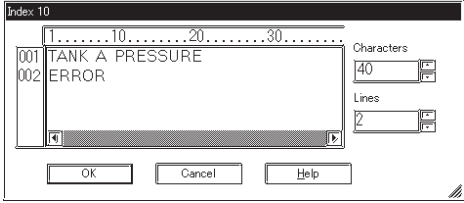
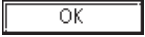
PROCEDURE	REMARKS
<p>(1) In the Project Manager, select the [Screen/Setup] menu - [Text Table...] command.</p> <p>(2) Click on the  icon and enter the [Control Address].</p> <p>(3) Select a font from the [Font Setting] menu . Select a table from <input type="checkbox"/> on the right of the "Table 1" field and select a font (language) from <input type="checkbox"/> on the right of the "GP Font Settings" field.</p> <p>(4) Double-click the index character string entry area.</p>  <p>(5) Enter the desired [Characters] and [Lines] according to the index character string.</p> 	<p>The table name can be modified by selecting [File] menu - [Table Name Change].</p> <p>You can choose from the following five selections.</p> <ul style="list-style-type: none"> • ASCII (Code Page 850) • CHINA (GB2312) • JAPAN(JIS) • KOREA (KS-C5601) • TAIWAN (Big5) <p>The number of characters used in the index character string is determined by [Characters] x [Lines]. (Max. 1,200) $[Characters] \times [Lines] \leq 1,200$</p> <p>Multiple display lines can be used for [Character string] and Parts [Label] only. For other features, do not specify an index number for which multiple display lines are set. If such an index number is specified, only the first line will be displayed.</p>

PROCEDURE	REMARKS
<p>(6) Enter the index character string.</p>  <p>(7) Click the  button to confirm the characters.</p> <p>(8) Repeat the same steps to set the index character strings for the other index numbers.</p> <p>(9) Repeat the same steps to create other tables.</p> <p>(10) Select the [File] menu - [Save] command or click on the  icon to save the setting.</p>	<p>Up to 16 tables can be registered.</p>

■ **Importing/Exporting CSV files**

You can export the contents of a table created using the Table Editor as a CSV file, or you can import a CSV file created using another table editor software into the Table Editor.

◆ **Importing CSV files**

Select the [File] menu - [Import] command.

Use the following dialog box to select the desired file.

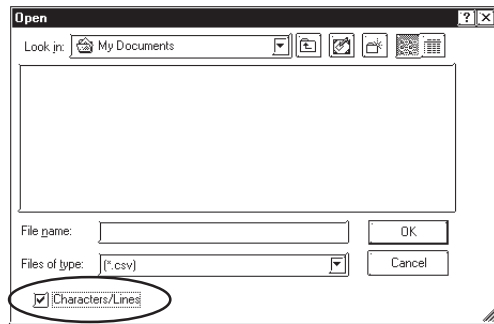

Important

- **When a CSV file is imported, the existing index character string is overwritten.**

- **When [Row/Column Import] is selected**

If the imported [characters] x [Lines] of CSV file's setting values are lower/less than the index character string values set in the [Table Editor], any excess/remaining characters in the [Table Editor] will be deleted during import.

- **When [Row/Column Import] is not selected**

If the imported CSV file's setting values are higher/greater than the index character string values set in the [Table Editor], any excess characters in the imported data will be deleted during import.

◆ **CSV file format for character string tables**

Header (Required for importing the file data.)

Table Data				
Table	Table 1			Table Name
Fond	0			Reserve
1	15	1	Abnormal pressure in tank A	Index Character String
2	15	2	Abnormal pressure in tank B	

Index Number

Characters/Lines

4.6.3 Entering Settings via the Screen Editor

■ Selecting the drawing table

From the menu bar in the Screen Editor, select the table to use for drawing. When a table is changed, the character strings used in the Screen Editor also change.

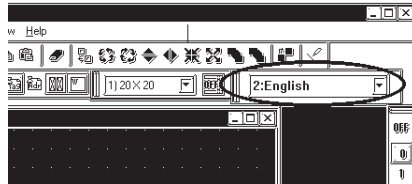

■ Selecting the index character string

◆ Entering the index character string

Click on the [Index] to switch the screen to the one used to enter the index character string.

Select the desired index character string from those shown in the [Table Editor]. To add a new index character string, click the button to start the [Table Editor].

Reference [4.6.2 Table Editor Index Character Strings](#) ■ *Index Character String Registration*

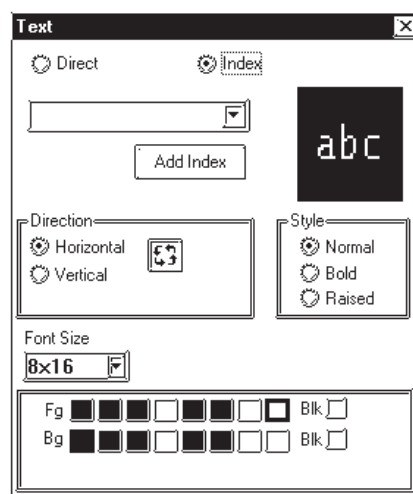

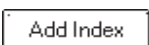

Note: The size of any text object placed on the drawing area automatically changes according to the size specified in the Table Editor ([Characters] x [Lines]). Switching tables does not change the text size.

■ Designating Part's label

Select [Index] in the Part's [Label] area to change to the index character string entry screen. Select the desired [Index] from those specified in the [Table Editor]. To add a new [Index], click the  button to start the [Table Editor].

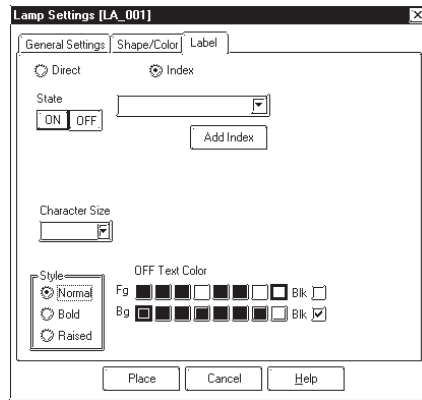
▼ **Reference** ■ *Index Character String Registration*



 **Note:** The size of any text placed on the drawing area automatically changes according to the size specified in the Table Editor ([Characters] x [Lines]). Switching tables does not change the text size.

◆ Selecting Alarm Editor Messages

First, select [Text Method] in [Alarm] in the [Alarm Editor] and change the character string setting mode to [Index].

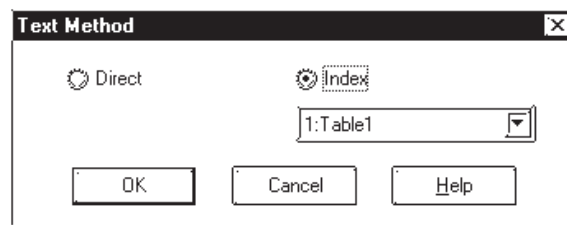

When the character string setting mode is changed, all previously registered alarm messages are deleted.

Then, click  in [Message/Summary Text] to view the list of [Index character strings] specified in the [Table Editor]. Select the desired Index Text from the Index Texts registered on the Text Table Editor.

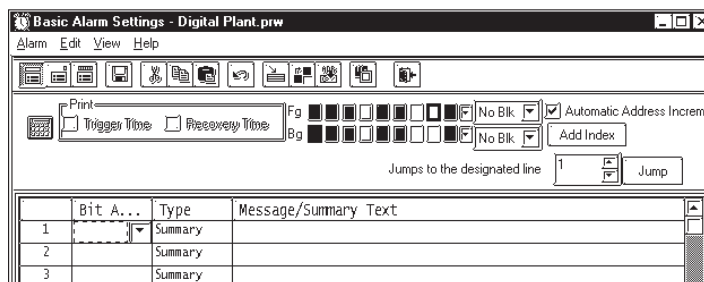

[Index character strings] can also be selected by choosing [Add Alarm(s)] in [Edit].

If you want to add a new [Index], click the **Add Index** button to start the [Table Editor]. **Reference** 4.6.2 Table Editor Index Character Strings

■ Index Character String Registration



Important

- **When messages are registered with the Alarm Editor, Direct Text and Index Text cannot be mixed.**
- **Do not set up an Index Text with two or more lines. Only the first line will be displayed, even if two or more lines have been set up.**

4.7 Symbol Editor

The Symbol Editor enables you to assign an address to a symbol and then register that symbol and to assign a device comment to an address and then register it.

The “Symbol” is the registered name used to indicate the address of any Tag or Part. Thus, when you change the address corresponding to a symbol, you will automatically change a Part or Tag's address(es) without having to re-setting the Tag or Part. The “device comment” indicates a comment assigned (attached) to each address. When setting a Tag or Part's address(es), simply clicking on  ([Apply Device Comment]) reflects the registered device comment to the Tag or Part's comment field.

Reference 2.1 Parts ■ *Entering a Comment*

In all the address entry fields, such as of Tags and Parts, addresses registered via the Symbol Editor will be displayed in a pull-down list together with the symbols or device comments. Addresses can also be specified here by selecting them from this list.

Reference 2.1 Parts ■ *Entering Addresses*

The symbol and device comment data can be shared between multiple Projects by import and export.

Note: The registered symbol and device comment information can be printed as a symbol list.

Reference 9.1.1 *Printing*

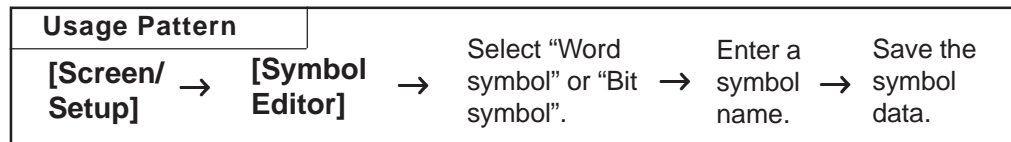
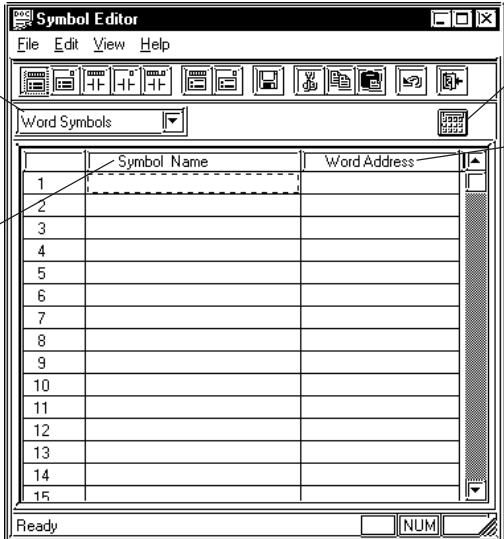
Select a desired symbol or comment.

Enter a symbol name of up to twenty characters

Pop-up Keypad

Enter the address(es) corresponding to the symbol's or description's name

■ Symbol Editor Types

There are five types of symbols: the Word symbol corresponding to a word address, the Bit symbol corresponding to a bit address, the GLC Integer symbol, the GLC Discrete symbol, and the GLC Real Number symbol that correspond to GLC symbols and can be imported only when the GLC series is selected.

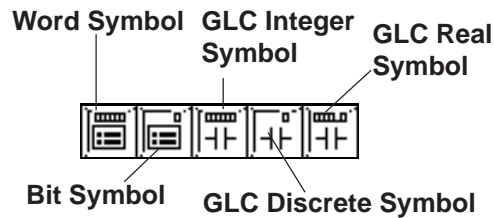

Reference For further explanations of the GLC symbol, refer to *Pro-Control Editor Operation Manual (packaged with the Pro-Control Editor)*



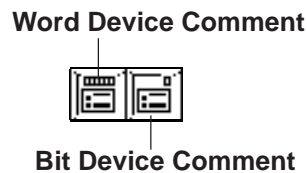

■ Device Comment Types

There are two types of bit device comments: the word device comment corresponding to a word address and the bit device comment corresponding to a bit address.



■ Edit Commands

To edit symbols, you can use the following commands:

-  Used to delete a symbol's line of data and store it on the clipboard. The Paste command allows you to then move that symbol to another line.
-  Used to copy a selected line of data to the clipboard.
-  Used to insert the line of data temporarily stored on the clipboard into the desired row, after the Cut/Copy command has been performed.
-  Used to cancel the command previously performed and return to the previous condition. However, an edited symbol character cannot be restored.

■ Using the Cut/Copy/Paste Commands

Cut/Copy/Paste commands can be used to move data between different Symbol Editor files. To do this, simply open another LBE file and select a desired line. Then, use the [Cut] or [Copy] command, and then the Symbol Editor's [Paste] command.







Do not register the same symbol name for both a word symbol and a bit symbol.

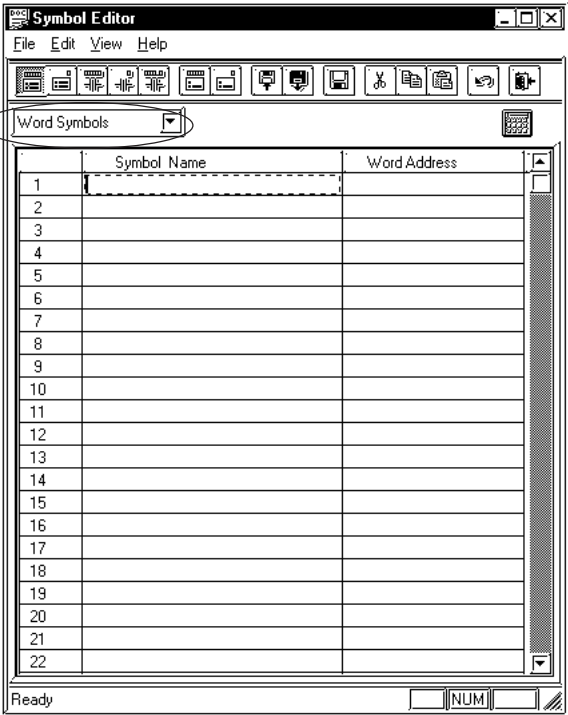

- *If alphanumeric numerals are used at the end of a symbol name, executing the [Copy] and [Paste] command will automatically change the symbol's name.*
- *When Chinese characters and numbers are used in a symbol name:
All the Arabic numbers to the right of the Chinese character(s) will be deleted. Sequence numbers starting from "2" will be assigned after the Chinese characters.*
- *When Roman characters and Arabic numbers are used in a symbol name:
Example) ABC123
All the Arabic numerals to the right of Roman character(s) will be deleted and replaced by a sequence number.*
- *When only Arabic numbers are used in a symbol name:
Only the first number is retained, and all other digits are truncated and replaced with a sequence number.*

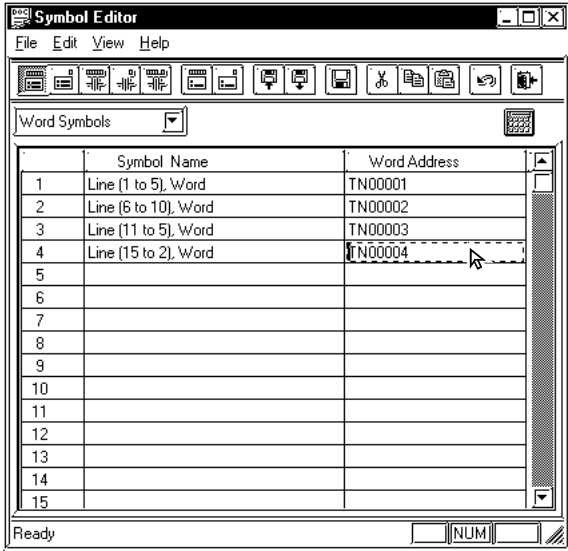
■ Registering Symbols and Device Comments

PROCEDURE	REMARKS
<p>(1) Via the Project Manager, select the [Screen/Setup] menu - [Symbol Editor] command.</p> <p>(2) Select symbol or device comment type. In this example, please select "Word Symbols".</p> 	<p>If the GLC series is selected for the GP type, the GLC symbol can be specified.</p> <p>Reference <i>Pro-Control Editor Operation Manual (packaged with the Pro-Control Editor).</i></p>

PROCEDURE	REMARKS
<p>(3) Enter symbol names and addresses.</p> 	<p>To enter a symbol name, you can use up to twenty alphanumeric characters, or up to ten Chinese characters.</p> <p>The entered characters are not case-sensitive.</p> <p>You can perform the [Delete] or [Copy] and [Paste] commands after selecting multiple messages.</p> <p> <i>Important</i></p> <p>The symbols [], \, ?, and the  key cannot be used in the Symbol Editor.</p>
<p>(4) After all the necessary items are registered, select the [File] menu - [Save] command, or click on the  icon.</p>	

■ Importing Symbols and Device Comments

The previously saved Symbol Editor data can be imported to and shared with the currently open Symbol Editor. Files with the extension of "*.LBE" or "*.CSV" can be imported.

CSV files that have been created via a text editor, Microsoft Excel, or other applications can be used as symbol or device comment data via the Symbol Editor after imported.

Symbol data and device comment's CSV file formats are as follows:

<Symbol Data CSV Format>

"GP_SYMBOL"

"Symbol Name", "Word Address"

<Give one line feed between a word address and a bit address>

"Symbol Name", "Bit Address"

Example

"Line A (1 to 5): Word", "D00100"

"Line A (6 to 10): Word", "D00101"

"Line A (1 to 5): Bit", "X00100"

"Line A (6 to 10): Bit", "X00101"

➤ One line feed

<Device Comment Data CSV Format>

```
"GP_COMMENT"
"Word Address", "Device Comment Name"
<Give one line feed between a word address and a bit address>
"Bit Address", "Device Comment Name"
```

Example

```
"GP_COMMENT"
"D00100", "Machine A stops"
"D00101", "Machine A is now operating"
"X00100", " Pump B"
"X00101", " Pump B"
```

} One line feed



- "GP_SYMBOL" and "GP_COMMENT" are identifiers indicating they are Symbol and Device Comment Data, respectively.
- Give a line feed only between a word symbol and a bit symbol. If an unnecessary line feed is given in any other place, data cannot be imported.

PROCEDURE	REMARKS
<p>Import symbol data.</p> <p>(1) Select the [File] menu - [Import Symbol] command, or click on the icon.</p> <p>(2) Select a file (*.LBE or *.CSV) to be imported or enter the file name, and click on the button.</p> <div style="border: 1px solid black; padding: 5px; margin: 10px 0;"> </div> <p>If the same symbol name already exists, the system asks if you wish to replace the symbol name.</p>	<p>To import a device comment, select the [Import Device Comment] command.</p> <div style="text-align: center; margin: 10px 0;"> </div> <p>To import a device comment, select the [Import Device Comment] command.</p>

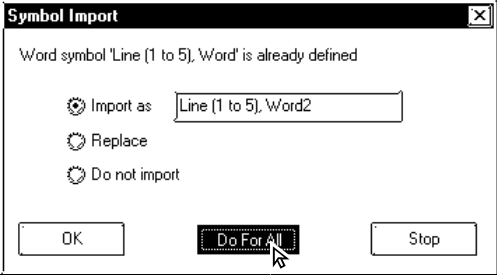
PROCEDURE	REMARKS
<p>(3) Select an import method and execute it. To import the specified symbol according to the current settings, click on the <input type="button" value="OK"/> button. To import the current Project file's all the symbols according to the current settings, click on the <input type="button" value="Do For All"/> button. To cancel the import, click on the <input type="button" value="Stop"/> button.</p> 	<p>[Import as] Enter the symbol name to be replaced. If no symbol name is entered, the original symbol name plus sequence numbers will be imported.</p> <p>[Replace] The same symbol name will be overwritten.</p> <p>[Do not import] The same symbol name will not be imported.</p>



- GP-PRO/PB III for Windows has "CMTCNV.EXE", a tool to convert Mitsubishi's Windows GPP function software SWOD-GPPW comment data to CSV files. For more detailed information about this tool, refer to "Readme.txt" in the folder "\\ProPB_Win\CMTCNV" created at GP-PRO/PB III for Windows installation.
- Amount of the Symbol data created or imported via the Symbol Editor is not limited. However, the number of device comment characters is up to 20.
- Items with an inappropriate device name are not imported.

■ Exporting Symbols and Device Comments

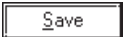
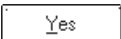
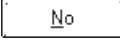
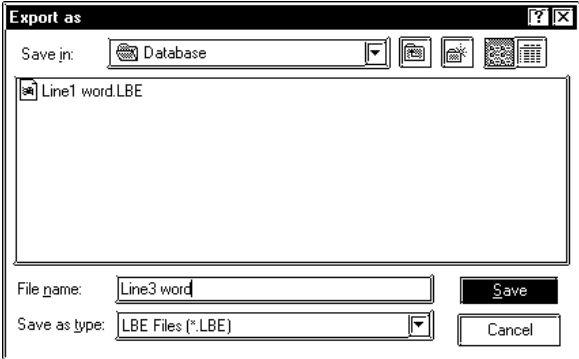
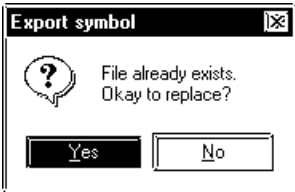

Data registered via the Symbol Editor is exported and saved as an LBE or CSV file. By importing this data, the Symbol Editor data can be shared among Projects.

PROCEDURE	REMARKS
<p>Export symbol data.</p> <p>(1) Via the Symbol Editor, select the [File] menu - [Export Symbol] command, or click on the  icon.</p> <p>(2) Specify the name and type (*.LBE or *.CSV) of the file to save the exported data with, and click on the  button.</p> <p>If the same file name already exists, the system asks if the existing file must be overwritten. If it must be overwritten, select  . If you do not wish to overwrite it, select  .</p>  <p style="text-align: center;">↓</p> 	<p>To export a device comment, select the [Export Device Comment] command.</p>

■ **Calling up Device Comments**

All the comments that have already been registered with Tags and Parts can be called up on the Symbol Editor as device comments. For addresses corresponding to each Tag and Part's comment, refer to the Input Description Address Table.

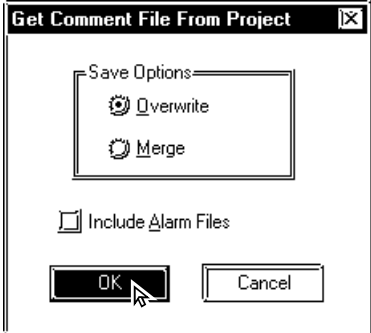

Reference 2.4.7 Duplicate

PROCEDURE	REMARKS
<p>(1) Select the [File] menu - [Get Device Comment From Project].</p> <p>(2) Select a device comment calling up method and click on the <input type="button" value="OK"/> button.</p> <p>[Overwrite] ... The device comment is called up after the already assigned address is deleted.</p> <p>[Merge] ... The device comment is called up in addition to the already assigned address.</p> 	 <p>Important</p> <p>Multiple addresses may be given to a tag or part depending on its type. In this case, device comments will be called up for all the assigned addresses.</p> <p>To call up an alarm message from the Alarm Editor, mark the [Include Alarm Files] check box.</p>

4.8 Device Monitor

You can monitor and change a desired area of device memory via the GP unit's Global Window screen. In this section, you must specify whether or not to register the "device monitor" command for the current GP unit. This registration is effective only when GP and PLC types which support the device monitor command are selected.

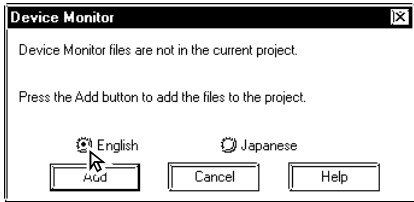
Reference *Device/PLC Connection Manual, Appendix 3: Device Monitor*

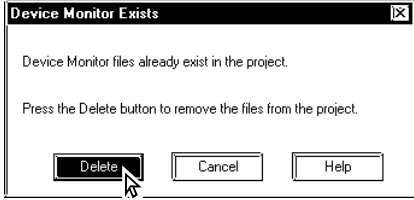
PROCEDURE	REMARKS
<p>(1) Select the [Screen/Settings] menu - [Device Monitor] command. Register the Device Monitor.</p> <p>(2) Specify which version of device monitor is to be used, the Japanese version or the English version.</p>  <p>(3) Click on the Add button. This completes registration of the device monitor feature. After the registration is completed, the following message appears.</p>  <p>To cancel the device monitor registration data, the following message will appear in step (2). Then, click on the Delete button to cancel it.</p> 	<p>If you change the Device/PLC type after the device monitor command is registered, the device monitor command will not operate correctly on the GP unit. To change the Device/PLC type, first, delete the device monitor registration before saving the current file.</p> <p>To use the device monitor command, be sure to select the "Indirect (Binary)" operation mode in the [GP Setup] - [Extended Settings] - [Global Window Settings].</p>

This feature allows you to register text data to be displayed as alarm messages. This chapter describes how to create and edit these alarm messages.

5.1 Alarm Creation and Editing

5.1 Alarm Creation and Editing

With this feature you can register the messages to be displayed in the “Alarm Summary” (specified by an “a-Tag” or a “Q-Tag”) and “Alarm Message” (right to left scrolling display). You can also set up a monitor bit for each message. According to the monitor bit’s ON/OFF status, the specified messages are then displayed in the “Alarm Summary” or “Alarm Message” mode.

Reference *Tag Reference manual, 2.2 a-tag (Alarm Summary Display), 2.20 Q-tag (Alarm Summary Display)*

The “Alarm Summary” mode lists messages. The “Alarm Message” mode displays a flowing message at the bottom of the screen. With “Alarm Message” text, the horizontal and vertical size of the text is specified in the [Setup Area’s (Initial Setup screen)] menu or in the GP unit’s [Setup] mode. Character sizes can be set to either “x 1”, “x 2”, or “x 4”. When the horizontal and vertical sizes are set to “1 x 1”, an alphanumeric character occupies 16 x 8 dots, and a Chinese character occupies 16 x 16 dots. The “Alarm Summary” and “Alarm Message” will display on the GP unit’s panel screen as shown below:

Alarm Summary Display Alarm Message Display

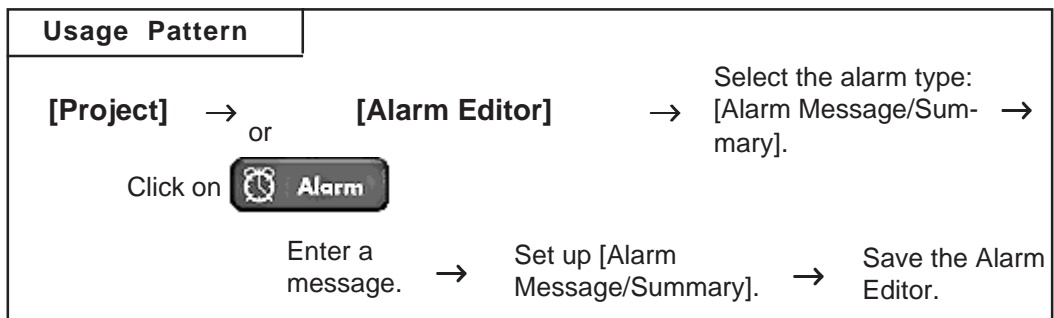
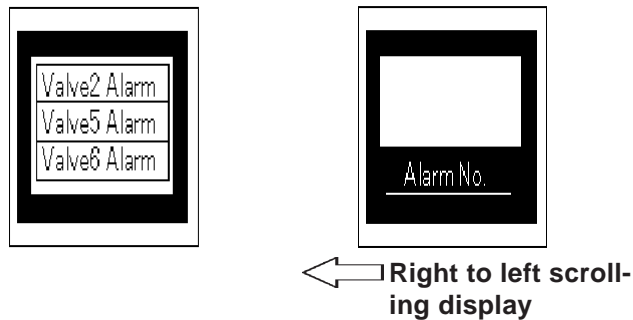

5.1.1 Alarm Editor

Via the Alarm Editor, messages and monitor bits are registered for each alarm type. An example of an Alarm Message screen used for entering a message is as follows. The Alarm Editor provides three types of alarms: [Alarm Message/Summary], [Bit Alarm Log] and [Word Alarm Log].

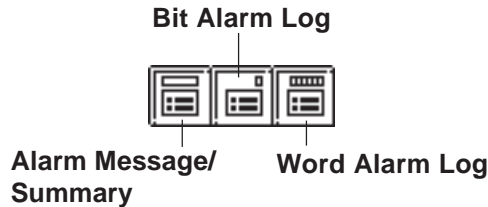

Note: The tab width for each item in the Alarm Editor (message/bit log/word log) can be adjusted by positioning the mouse pointer on the border between items and then dragging it. The changed size will be saved, and used on the subsequently opened screens.

■ **Alarm Message/Summary Screen**

Here, you can register the messages to be displayed as either “Alarm Summary” (specified by an “a-Tag”) or as “Alarm Message” (right to left scrolling display). The message can be registered up to 8999 lines.

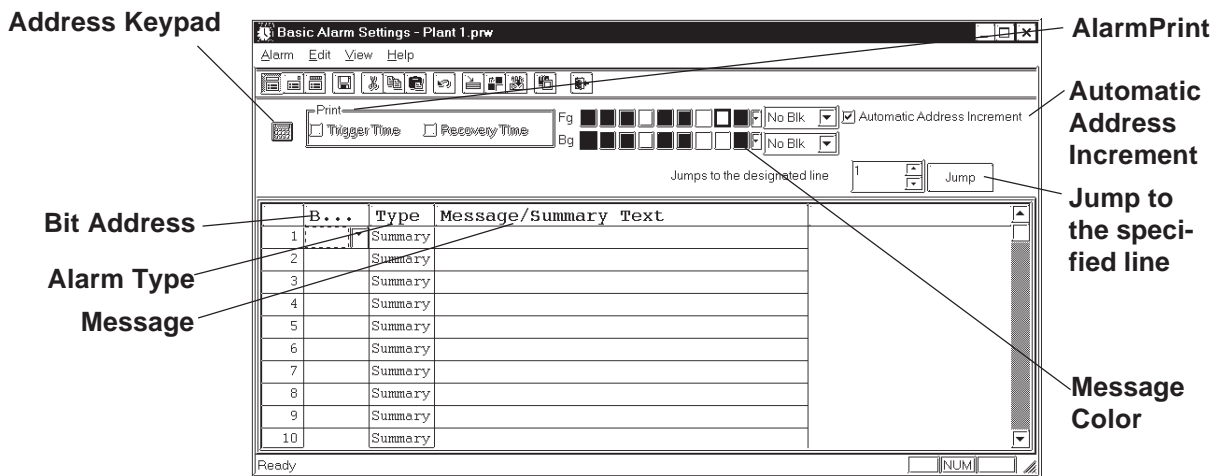

◆ **Bit Address**

Specifies the monitor bit. To specify the bit address for the “Alarm Summary” mode, select a device that can be specified by word.

▼ **Reference** ▲ *Device/PLC Connection Manual*

◆ **Alarm Type**

The Alarm Editor provides two types of alarms: [Alarm Summary] and [Alarm Message].

The [Alarm Summary] mode lists messages specified by an “a-Tag”.

The [Alarm Message] mode displays a scrolling message at the bottom of the GP’s screen. Up to 512 messages can be entered into the Alarm Editor (up to 128 messages for GP70 series units). However, the monitor bit does not exceed 128 words. Any message beyond this setting range will not operate on the GP unit’s panel screen.

◆ **Message**

Enter your message here. Up to 160 alphanumeric characters can be entered for one message. Index Text can be used to switch messages on the GP-377, GP77R and GP2000 series.

▼ **Reference** 4.6.3 *Entering Settings via the Screen* ◆ *Selecting Alarm Editor Messages*

◆ **Address Keypad**

A address keypad is displayed, allowing you to enter the bit address using the mouse.

◆ **Message Color**

Designates message’s color. Select the display color (Fg) and background color (Bg), and specify whether to blinking (Blk) is used or not.

◆ **Automatic Address Increment**

After entering and registering a message in a line and moving to the next line, an address that is one bit larger will be automatically entered for the new line.

◆ **Jump to the designated line.**

Specify a line and click to jump to the line.

◆ **Print**

An Alarm Message (like a bulletin board) can be printed out when the alarm is triggered and when recovered. Specify if the Alarm Message is printed out at the triggering of the alarm and at the recovery from the alarm, respectively. When [Summary] is selected, this setting becomes ineffective.



This function is supported only by the GPs with a printer interface.

Trigger Time: Prints out the time when the Alarm Message started.

Recovery Time: Prints out the time when the Alarm Message is finished.

Printing Example

Trigger	10/15	16:07	No.1 error
Recovery	10/15	16:30	No.1 error
Trigger	10/21	11:25	No.1 error
Trigger	10/21	11:28	No.3 error
Recovery	10/21	15:45	No.1 error



- **Up to 1,000 Alarm Message triggering and recovery events can be stored in the GP. When the GP is not connected to a printer, up to 1,000 events will be stored in the GP, which enters a printing stand-by mode. When the number of the events exceeds 1,000, the excessive events will not be stored.**
- **When a printer becomes offline mode due to the running out of printing paper during printing, DO NOT turn the GP's power OFF. Refill the paper and return the printer to online mode. Event information stored in the GP in the printer offline mode will be output to the printer when the printer mode returns to online.**
- **If the printer's power is turned OFF during printing, event information transferred from the GP to the printer while the printer's power is OFF will not be printed.**

■ **Bit Log Alarm**

This screen is used to register messages to be displayed in an “Alarm Summary” (specified by a “Q-Tag”). The maximum number of messages for both the Bit Log Alarm and Word Log Alarm varies depending on the GP type.

GP type	Maximum Number of Messages
GP-270, GP-H70, GP-370	512
Other GP70 series and GP77R series	768
GP2000 series	2048 ^{*1}

*1 The 769th message and thereafter cannot be registered with Word Log Alarm.

Note that the total number of alarms to be stored as Bit Log Alarms and Word Log Alarms is 768.

▼ **Reference** ▲ *Tag Reference Manual, 2.20.9* ◆ **Q-tag Setting**

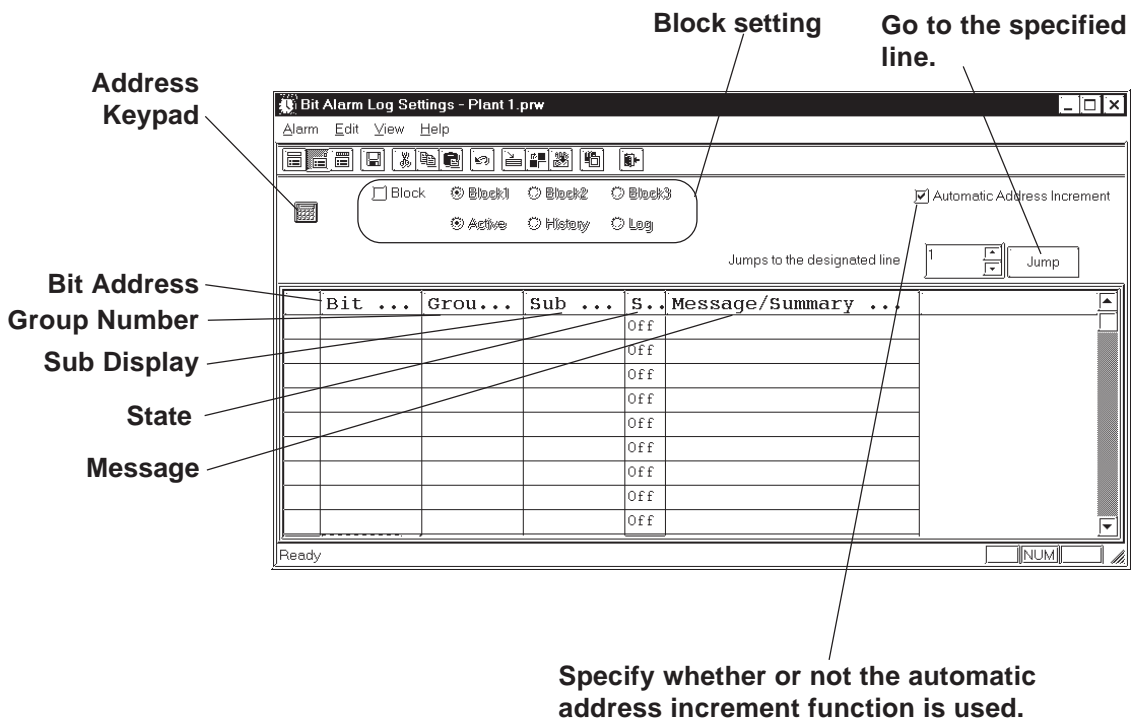

◆ **Address Keypad**

A address keypad is displayed, allowing you to enter the bit address using a mouse.

◆ **Bit Address**

Enter the bit address used for monitoring. Specify the bit address so that the monitor bit (Bit Log Alarm combined with the Word Log Alarm) does not exceed 256 words.

◆ **Group No.**

Enter a group number for counting alarms.

The counting of alarms with the same group number will be stored in the same LS area. LS areas are automatically reserved, for as many group numbers as have been specified. Bit log alarms and word log alarms with the same group number are counted as the same group.

In order to set up the area in which the number of alarm occurrences is written, select [GP Setup] from the Project Manager. Select [Triggered Alarm Count Address] from the [Q-Tag Settings] menu on the [Extended Features] tab.



Select [System Settings] from the [Alarm] menu on the Alarm Editor screen, or click  to enter the "Q-Tag Settings" dialog box.

◆ **Sub Display**

To perform sub-display with a Q-tag, specify here a desired sub-display screen number corresponding to each message and the same number as a window registration number. These number may be entered in a range between 0 and 8999.

Example 1: To sub-display a screen of B2, enter 2.

Example 2: If no sub-display is required, enter 0 (default value is 0).

◆ **State**

Specify the monitor bit status (ON/OFF) that activates the alarm output.

◆ **Message**

Enter a message. Up to 100 alphanumeric characters can be entered for one message. Index Text can be used to switch messages on the GP-377, GP77R and GP-2000 series.

▼ **Reference** 4.6.3 *Entering Settings via the Screen* ■ *Selecting Alarm Editor Messages*

◆ **Block Setting**

If "Block" is selected for the GP-377, GP37W2, GP77R and GP2000 series, the attribute of "Active", "Log" or "History" can be given to each block. Up to three blocks can be set.

▼ **Reference** *Tag Reference Manual, 2.20 Q-tag (Alarm Summary Display)*

◆ **Automatic Address Increment**

After entering and registering a message in a line and moving to the next line, an address that is one bit larger is automatically entered for the new line.

■ **Word Alarm Log**

This screen is used to register the messages to be displayed in an “Alarm Summary” (specified by a “Q-Tag”). The maximum number of messages for both the Bit Log Alarm and Word Log Alarm varies depending on the GP type.

GP type	Maximum Number of Messages
GP-270, GP-H70, GP-370	512
Other GP70 series and GP77R series	768
GP2000 series	2048 ^{*1}

*1 The 769th message and thereafter cannot be registered with Word Log Alarm.

Note that the total number of alarms to be stored as Bit Log Alarms and Word Log Alarms is 768.

▼ **Reference** ▲ *Tag Reference Manual, 2.20.9* ◆ **Q-tag Setting**

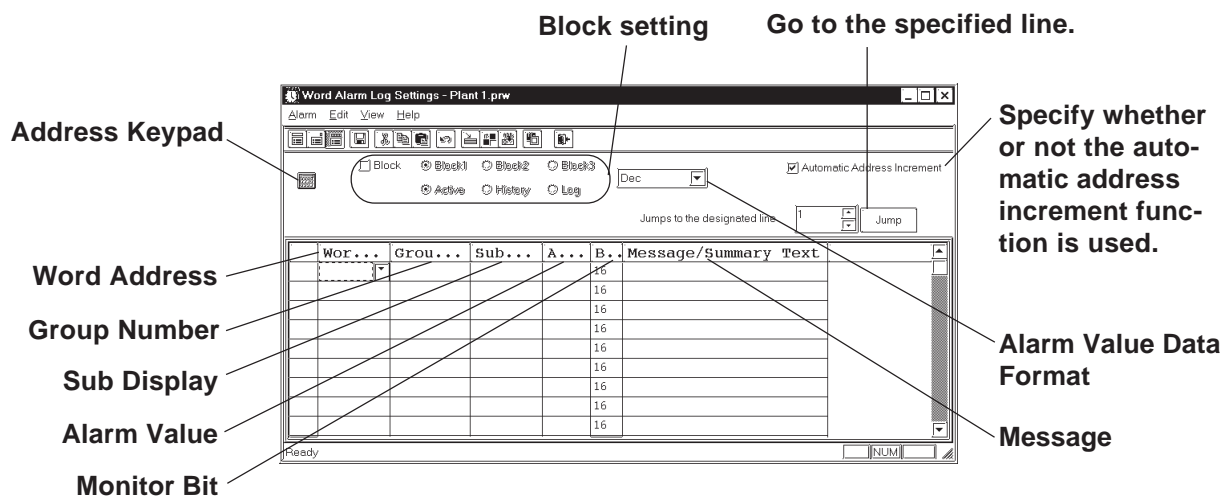

◆ **Address Keypad**

Clicking here displays a address keypad, allowing you to enter bit address data using your mouse.

◆ **Alarm Value Data Format**

Selects the alarm value’s data format.

◆ **Word Address**

Set up a word address. Specify the bit address so that the monitor bit (Bit Log Alarm combined with the Word Log Alarm) does not exceed 256 words.

◆ **Group No.**

Enter a group number for counting alarms.

The counting of alarms with the same group number will be stored in the same LS area. LS areas are automatically reserved, for as many group numbers as have been specified. Bit log alarms and word log alarms with the same group number are counted as the same group.

In order to set up the area in which the number of alarm occurrences is written, select [GP System Setup] of the Project Manager. Select [Triggered Alarm Count Address] from the [Q-Tag Settings] menu on the [Extended Feature Settings] tab.



Select [System Settings] from the [Alarm] menu on the Alarm Editor screen, or click  to enter the "Q-Tag Settings" dialog box.

◆ **Sub Display**

To perform sub-display with a Q-tag, specify here a desired sub-display screen number corresponding to each message and the same number as a window registration number. These number may be entered in a range between 0 and 8999.

Example 1: To sub-display a screen of B2, enter 2.

Example 2: If no sub-display is required, enter 0 (default value is 0).

◆ **Alarm Value**

Specify the limit value of the monitor word used to activate the alarm's output.

◆ **Monitor Bit**

Select "16 bits" for single-word monitoring, or "32 bits" for two-word monitoring.

◆ **Message**

Enter a message. Up to 100 alphanumeric characters can be entered for one message. Index Text can be used to switch messages on the GP-377, GP77R and GP2000 series.

Reference  4.6.3 Entering Settings via the Screen ◆ Selecting Alarm Editor Messages

◆ **Block Setting**

If "Block" is selected for the GP-377, GP37W2, GP77R and GP2000 series, the attribute of "Active", "Log" or "History" can be given to each block. Up to three blocks can be set.









Reference  Tag Reference Manual, 2.20 Q-tag (Alarm Summary Display)

◆ **Automatic address increment**

After entering and registering a message in a line and moving to the next line, an address that is one bit larger is automatically entered for the new line.

■ Editing Tools



The Alarm Editor has the following editing features.



Icon	Editing Tool	Description
	Cut	Used to delete a symbol's line of data and store it on the clipboard. The [Paste] command allows you to then move that symbol to another line.
	Copy	Used to copy a selected line of data to the clipboard.* ¹
	Paste	Used to insert the line of data temporarily stored on the clipboard into the desired row, after the Cut/Copy command has been performed.
	Undo	Used to cancel the command previously performed and return to the previous condition. However, an edited symbol character cannot be restored.
	Add Alarm	Adds an address. If the selected alarm number already exists, that data can be overwritten.
	Change Attribute	Allows you to change the alarm attributes.
	Apply Device Comment	Inputs device comments for all the selected devices in the Message Column.
	System Settings	Allows you to go to the "Q-tag Settings" dialog box from the "Alarm Editor". Press the [OK] button to save the settings for the Q-tag.

**1 When the [Copy] or [Cut] command is executed, the copied or deleted data is temporarily stored on the clipboard. When you execute the [Paste] command, the data stored on the clipboard can be copied or moved to a desired position.*

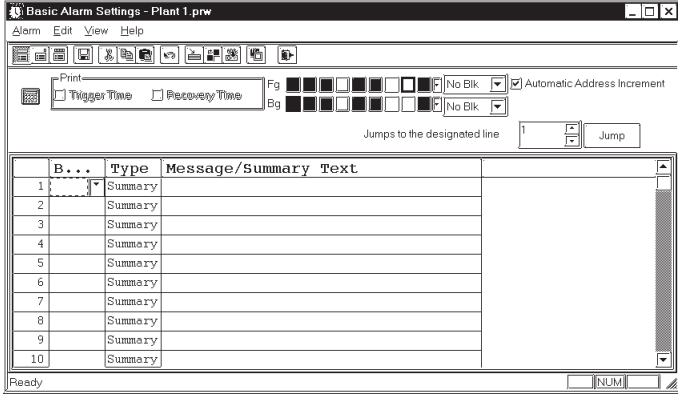
5.1.2 Creating an Alarm

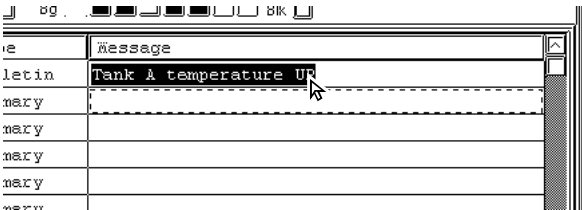
This section describes how to create and register alarm messages using Alarm Editor.

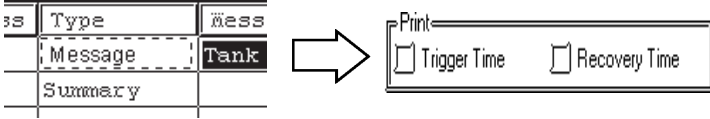
PROCEDURE	REMARKS
<p>(1) Via the Project Manager, select the [Screen/Setting] menu - [Alarm Editor] command, or click on the  icon to open the Alarm Editor.</p> 	<p>Entering data in the Alarm Editor only does not activate the “Alarm Summary” mode. To activate the “Alarm Summary” mode, you must set up an “a-Tag” for the Base screen where the message is displayed.</p>
<p>(2) Specify the bit address (monitor bit).</p> 	<p>When designating an Alarm summary's bit address, be sure to select a device that can use word designated units.</p> <p>Reference <i>Device/PLC Connection Manual, 2.*.3/5.*.3 Supported Devices</i></p>
<p>(3) Enter a message.</p> <p>Enter the message to be displayed on the GP unit panel during alarm output. Select a message color, if desired.</p> 	<p>Up to 160 alphanumeric characters can be entered for one Basic Alarm message.</p> <p>After selecting several messages by dragging the mouse, you can use the [Copy] and [Paste] commands.</p>



PROCEDURE	REMARKS
<p>(4) Select the alarm type: Alarm “Message” or Alarm “Summary”. If you select “Message”, you can also designate the alarm trigger/recovery time history print command.</p>  <p>(5) After entering all the necessary items, select the [Alarm] menu - [Save] command, or click on the  icon. The specified alarm data will be stored in the currently opened project file.</p>	<p>Up to 512 alarm messages can be registered. However, set the monitor bits within 128 words.</p> <p>Alarm messages can be printed with GP-470, GP-571T, GP-675, GP-870, GP77R and GP2000 (except GP2000H) series. To perform printing with GP-377R, however, a Multi Unit (sold separately) will be needed.</p> <p>If a message has not been entered, the Alarm Editor data cannot be saved, even if the bit addresses have been specified.</p>

5.1.3 Editing Alarm Data

This section describes how to use the Alarm Editor's editing commands.

■ Cut/Move



Here, you can delete the selected line of alarm data and store it on the clipboard.

PROCEDURE	REMARKS																																																																						
<p>(1) Select the line of alarm data to be moved.</p> <table border="1"> <tr><td>1</td><td>X0010</td><td>Bulletin</td><td>Tank A temperature UP</td></tr> <tr><td>2</td><td>X0050</td><td>Summary</td><td>Tank B temperature UP</td></tr> <tr><td>3</td><td>X0051</td><td>Summary</td><td>Tank C temperature UP</td></tr> <tr><td>4</td><td>X0052</td><td>Summary</td><td></td></tr> </table> <p>(2) Select the [Edit] menu - [Cut] command, or click on the  icon to import alarm data to the Clipboard. The selected alarm data will be deleted and stored.</p> <table border="1"> <thead> <tr><th>Bit Address</th><th>Type</th><th>Message</th></tr> </thead> <tbody> <tr><td>1</td><td>X0010</td><td>Bulletin</td><td>Tank A temperature UP</td></tr> <tr><td>2</td><td>X0050</td><td>Summary</td><td>Tank B temperature UP</td></tr> <tr><td>3</td><td></td><td>Summary</td><td></td></tr> <tr><td>4</td><td>X0052</td><td>Summary</td><td></td></tr> <tr><td>5</td><td>X0053</td><td>Summary</td><td></td></tr> </tbody> </table> <p>(3) Select the insertion line.</p> <table border="1"> <thead> <tr><th>Bit Address</th><th>Type</th><th>Message</th></tr> </thead> <tbody> <tr><td>1</td><td>X0010</td><td>Bulletin</td><td>Tank A temperature UP</td></tr> <tr><td>2</td><td>X0050</td><td>Summary</td><td>Tank B temperature UP</td></tr> <tr><td>3</td><td></td><td>Summary</td><td></td></tr> <tr><td>4</td><td>X0052</td><td>Summary</td><td></td></tr> <tr><td>5</td><td>X0053</td><td>Summary</td><td></td></tr> <tr><td>6</td><td>X0054</td><td>Summary</td><td></td></tr> <tr><td>7</td><td>X0055</td><td>Summary</td><td></td></tr> </tbody> </table> <p>(4) Select the [Edit] menu - [Paste] command, or click on the  icon to paste alarm data to the destination from the Clipboard. If the same number already exists, the system asks if each file must be overwritten. If you select <input type="button" value="Yes"/>, the desired data will be overwritten. If you select <input type="button" value="No"/>, the desired file will not be overwritten, and the system will ask the same question for the next alarm. If you select <input type="button" value="Yes to All"/>, all existing alarms will be overwritten. If you select <input type="button" value="No to All"/>, you will return to the menu screen.</p>	1	X0010	Bulletin	Tank A temperature UP	2	X0050	Summary	Tank B temperature UP	3	X0051	Summary	Tank C temperature UP	4	X0052	Summary		Bit Address	Type	Message	1	X0010	Bulletin	Tank A temperature UP	2	X0050	Summary	Tank B temperature UP	3		Summary		4	X0052	Summary		5	X0053	Summary		Bit Address	Type	Message	1	X0010	Bulletin	Tank A temperature UP	2	X0050	Summary	Tank B temperature UP	3		Summary		4	X0052	Summary		5	X0053	Summary		6	X0054	Summary		7	X0055	Summary		<p>If a message has not been entered, Alarm Editor data cannot be saved, even if bit addresses have been specified.</p> <p>To select several lines, drag the mouse between the target lines, or click on the target line while holding down the <input type="button" value="Shift"/> or <input type="button" value="Ctrl"/> key.</p> <p>To delete the selected line(s), perform steps (1) and (2) only.</p>
1	X0010	Bulletin	Tank A temperature UP																																																																				
2	X0050	Summary	Tank B temperature UP																																																																				
3	X0051	Summary	Tank C temperature UP																																																																				
4	X0052	Summary																																																																					
Bit Address	Type	Message																																																																					
1	X0010	Bulletin	Tank A temperature UP																																																																				
2	X0050	Summary	Tank B temperature UP																																																																				
3		Summary																																																																					
4	X0052	Summary																																																																					
5	X0053	Summary																																																																					
Bit Address	Type	Message																																																																					
1	X0010	Bulletin	Tank A temperature UP																																																																				
2	X0050	Summary	Tank B temperature UP																																																																				
3		Summary																																																																					
4	X0052	Summary																																																																					
5	X0053	Summary																																																																					
6	X0054	Summary																																																																					
7	X0055	Summary																																																																					

PROCEDURE	REMARKS																																
<div style="border: 1px solid black; padding: 5px; margin-bottom: 10px;"> <p>Confirm Alarm Replace</p> <p>Alarm No 5 already exists! Overwrite?</p> <p> <input type="button" value="Yes"/> <input checked="" type="button" value="Yes to All"/> <input type="button" value="No"/> <input type="button" value="No to All"/> </p> </div> <div style="text-align: center; margin-bottom: 10px;">  </div> <p>The selected alarm data is moved to the specified line.</p> <table border="1" style="width: 100%; border-collapse: collapse;"> <thead> <tr> <th></th> <th>Bit Address</th> <th>Type</th> <th>Message</th> </tr> </thead> <tbody> <tr> <td>1</td> <td>X0010</td> <td>Summary</td> <td>Tank A stops</td> </tr> <tr> <td>2</td> <td>X0050</td> <td>Summary</td> <td>Tank B stops</td> </tr> <tr> <td>3</td> <td></td> <td>Summary</td> <td></td> </tr> <tr> <td>4</td> <td>X0052</td> <td>Summary</td> <td></td> </tr> <tr> <td>5</td> <td>X0051</td> <td>Summary</td> <td>Tank C stops</td> </tr> <tr> <td>6</td> <td>X0054</td> <td>Summary</td> <td></td> </tr> <tr> <td>7</td> <td>X0055</td> <td>Summary</td> <td></td> </tr> </tbody> </table>		Bit Address	Type	Message	1	X0010	Summary	Tank A stops	2	X0050	Summary	Tank B stops	3		Summary		4	X0052	Summary		5	X0051	Summary	Tank C stops	6	X0054	Summary		7	X0055	Summary		
	Bit Address	Type	Message																														
1	X0010	Summary	Tank A stops																														
2	X0050	Summary	Tank B stops																														
3		Summary																															
4	X0052	Summary																															
5	X0051	Summary	Tank C stops																														
6	X0054	Summary																															
7	X0055	Summary																															

■ Copy

Copies the selected line of alarm data, and stores it on the clipboard.

PROCEDURE	REMARKS																																							
<p>(1) Select the alarm line to be copied.</p> <table border="1"> <thead> <tr> <th></th> <th>Bit Address</th> <th>Type</th> <th>Message</th> </tr> </thead> <tbody> <tr> <td>1</td> <td>X00010</td> <td>Bulletin</td> <td>Tank A temperature UP</td> </tr> <tr> <td>2</td> <td>X00050</td> <td>Summary</td> <td>Tank B temperature UP</td> </tr> <tr style="background-color: #cccccc;"> <td>3</td> <td>X00051</td> <td>Summary</td> <td>Tank C temperature UP</td> </tr> <tr> <td>4</td> <td>X00052</td> <td>Summary</td> <td></td> </tr> <tr> <td>5</td> <td>X00053</td> <td>Summary</td> <td></td> </tr> </tbody> </table>		Bit Address	Type	Message	1	X00010	Bulletin	Tank A temperature UP	2	X00050	Summary	Tank B temperature UP	3	X00051	Summary	Tank C temperature UP	4	X00052	Summary		5	X00053	Summary		<p>Even if bit addresses have been specified, if message data has not been entered, the Alarm Editor data cannot be saved.</p> <p>To select several lines, drag the mouse between the target lines, or click on the target line while holding down the [Shift] or [Ctrl] key.</p>															
	Bit Address	Type	Message																																					
1	X00010	Bulletin	Tank A temperature UP																																					
2	X00050	Summary	Tank B temperature UP																																					
3	X00051	Summary	Tank C temperature UP																																					
4	X00052	Summary																																						
5	X00053	Summary																																						
<p>(2) Select the [Edit] menu - [Copy] command, or click on the  icon to import alarm data to the Clipboard. The selected alarm data will be copied to the clipboard.</p> <table border="1"> <thead> <tr> <th></th> <th>Bit Address</th> <th>Type</th> <th>Message</th> </tr> </thead> <tbody> <tr> <td>1</td> <td>X00010</td> <td>Summary</td> <td>Tank A temperature UP</td> </tr> <tr> <td>2</td> <td>X00050</td> <td>Summary</td> <td>Tank B temperature UP</td> </tr> <tr> <td>3</td> <td>X00051</td> <td>Bulletin</td> <td>Tank C temperature UP</td> </tr> <tr> <td>4</td> <td>X00052</td> <td>Summary</td> <td></td> </tr> <tr> <td>5</td> <td>X00051</td> <td>Bulletin</td> <td></td> </tr> </tbody> </table>		Bit Address	Type	Message	1	X00010	Summary	Tank A temperature UP	2	X00050	Summary	Tank B temperature UP	3	X00051	Bulletin	Tank C temperature UP	4	X00052	Summary		5	X00051	Bulletin																	
	Bit Address	Type	Message																																					
1	X00010	Summary	Tank A temperature UP																																					
2	X00050	Summary	Tank B temperature UP																																					
3	X00051	Bulletin	Tank C temperature UP																																					
4	X00052	Summary																																						
5	X00051	Bulletin																																						
<p>(3) Select the destination line.</p> <table border="1"> <thead> <tr> <th></th> <th>Bit Address</th> <th>Type</th> <th>Message</th> </tr> </thead> <tbody> <tr> <td>1</td> <td>X00010</td> <td>Summary</td> <td>Tank A temperature UP</td> </tr> <tr> <td>2</td> <td>X00050</td> <td>Summary</td> <td>Tank B temperature UP</td> </tr> <tr> <td>3</td> <td>X00051</td> <td>Bulletin</td> <td>Tank C temperature UP</td> </tr> <tr> <td>4</td> <td>X00052</td> <td>Summary</td> <td></td> </tr> <tr> <td>5</td> <td>X00051</td> <td>Bulletin</td> <td></td> </tr> <tr> <td>6</td> <td>X00054</td> <td>Summary</td> <td></td> </tr> <tr style="background-color: #cccccc;"> <td>7</td> <td>X00055</td> <td>Summary</td> <td></td> </tr> <tr> <td>8</td> <td>X00056</td> <td>Summary</td> <td></td> </tr> <tr> <td>9</td> <td>X00057</td> <td>Summary</td> <td></td> </tr> </tbody> </table>		Bit Address	Type	Message	1	X00010	Summary	Tank A temperature UP	2	X00050	Summary	Tank B temperature UP	3	X00051	Bulletin	Tank C temperature UP	4	X00052	Summary		5	X00051	Bulletin		6	X00054	Summary		7	X00055	Summary		8	X00056	Summary		9	X00057	Summary	
	Bit Address	Type	Message																																					
1	X00010	Summary	Tank A temperature UP																																					
2	X00050	Summary	Tank B temperature UP																																					
3	X00051	Bulletin	Tank C temperature UP																																					
4	X00052	Summary																																						
5	X00051	Bulletin																																						
6	X00054	Summary																																						
7	X00055	Summary																																						
8	X00056	Summary																																						
9	X00057	Summary																																						
<p>(4) Select the [Edit] menu - [Paste] command, or click on the  icon to paste alarm data to the destination from the Clipboard. If the same data already exists, the system asks if each file (item) must be overwritten. If you select <input type="button" value="Yes"/>, the desired file will be overwritten. If you select <input type="button" value="No"/>, the desired file will not be overwritten, and the system will ask the same question for the next alarm. If you select <input type="button" value="Yes to All"/>, all existing alarms will be overwritten. If you select <input type="button" value="No to All"/>, you will return to the menu screen.</p>																																								

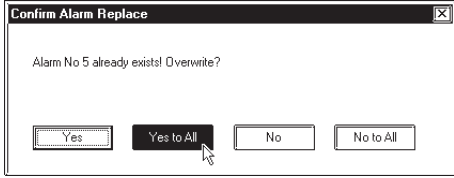
PROCEDURE	REMARKS																																												
 <p style="text-align: center;">↓</p> <p>The selected alarm data is copied to the specified line(s).</p> <table border="1" data-bbox="213 660 810 963"> <thead> <tr> <th></th> <th>Bit Address</th> <th>Type</th> <th>Message</th> </tr> </thead> <tbody> <tr><td>1</td><td>X0010</td><td>Bulletin</td><td>Tank A stops</td></tr> <tr><td>2</td><td>X0050</td><td>Summary</td><td>Tank B stops</td></tr> <tr><td>3</td><td>X0051</td><td>Summary</td><td>Tank C stops</td></tr> <tr><td>4</td><td>X0052</td><td>Summary</td><td></td></tr> <tr><td>5</td><td>X0053</td><td>Summary</td><td></td></tr> <tr><td>6</td><td>X0054</td><td>Summary</td><td></td></tr> <tr><td>7</td><td>X0051</td><td>Summary</td><td>Tank C stops</td></tr> <tr><td>8</td><td>X0056</td><td>Summary</td><td></td></tr> <tr><td>9</td><td>X0057</td><td>Summary</td><td></td></tr> <tr><td>10</td><td>X0058</td><td>Summary</td><td></td></tr> </tbody> </table>		Bit Address	Type	Message	1	X0010	Bulletin	Tank A stops	2	X0050	Summary	Tank B stops	3	X0051	Summary	Tank C stops	4	X0052	Summary		5	X0053	Summary		6	X0054	Summary		7	X0051	Summary	Tank C stops	8	X0056	Summary		9	X0057	Summary		10	X0058	Summary		<p>An alarm can be pasted onto alarms of different types. (For example, an alarm copied from "Alarm Message/Alarm Summary" can be pasted onto the "Bit Log Alarm".)</p> <p>Note that only the "message" will be pasted in this operation. Options other than the "message" must be set separately.</p>
	Bit Address	Type	Message																																										
1	X0010	Bulletin	Tank A stops																																										
2	X0050	Summary	Tank B stops																																										
3	X0051	Summary	Tank C stops																																										
4	X0052	Summary																																											
5	X0053	Summary																																											
6	X0054	Summary																																											
7	X0051	Summary	Tank C stops																																										
8	X0056	Summary																																											
9	X0057	Summary																																											
10	X0058	Summary																																											

■ **Undo**

This feature allows you to cancel the previously performed command, and return to the previous condition.

PROCEDURE	REMARKS																								
<p>When an alarm has been unintentionally deleted:</p> <p>(1) Select the [Edit] menu - [Undo] command, or click on the  icon.</p> <table border="1" data-bbox="213 1512 890 1697"> <thead> <tr> <th></th> <th>Bit Address</th> <th>Type</th> <th>Message</th> </tr> </thead> <tbody> <tr><td>1</td><td>X00010</td><td>Bulletin</td><td>Tank A temperature UP</td></tr> <tr><td>2</td><td>X00050</td><td>Summary</td><td>Tank B temperature UP</td></tr> <tr><td>3</td><td>X00051</td><td>Summary</td><td>Tank C temperature UP</td></tr> <tr><td>4</td><td>X00052</td><td>Summary</td><td></td></tr> <tr><td>5</td><td>X00053</td><td>Summary</td><td></td></tr> </tbody> </table>		Bit Address	Type	Message	1	X00010	Bulletin	Tank A temperature UP	2	X00050	Summary	Tank B temperature UP	3	X00051	Summary	Tank C temperature UP	4	X00052	Summary		5	X00053	Summary		<p>Edited message characters cannot be restored with the [Undo] command.</p>
	Bit Address	Type	Message																						
1	X00010	Bulletin	Tank A temperature UP																						
2	X00050	Summary	Tank B temperature UP																						
3	X00051	Summary	Tank C temperature UP																						
4	X00052	Summary																							
5	X00053	Summary																							

■ **Adding Alarm Data**

Here, you can add alarms for the specified number of bits or words from the line whose item is enclosed with dotted lines. Addresses are automatically assigned to each alarm from the start address in series, according to the designated address adding increment. In addition, when messages have been entered, they are copied for all the alarms to be added.

If an alarm number to be added already exists, a prompt will appear asking if the newly set data overwrites the old one.

The dialog box that appears will vary depending on the alarm type selected:

◆ **Alarm Message/Summary**

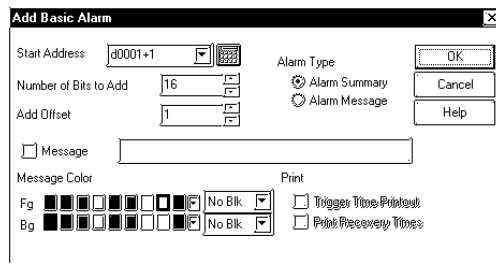



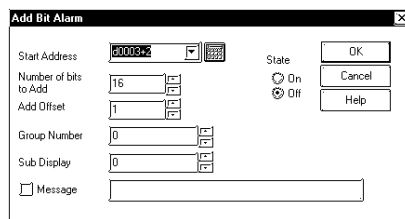

◆ **Bit Alarm Log**

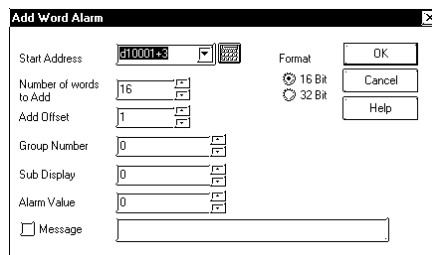

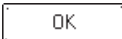
◆ **Word Alarm Log**

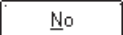
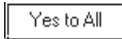
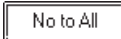

PROCEDURE	REMARKS																								
<p>(1) Select the address line where the specified number of addresses will be added. (Shown here with a dotted line around its border)</p> <table border="1" style="width: 100%; border-collapse: collapse;"> <thead> <tr> <th>Line</th> <th>Start Address</th> <th>Type</th> <th>Message</th> </tr> </thead> <tbody> <tr> <td>1</td> <td>X0010</td> <td>Bulletin</td> <td>Tank A Temperature UP</td> </tr> <tr style="border: 1px dotted black;"> <td>2</td> <td>X0001</td> <td>Summary</td> <td></td> </tr> <tr> <td>3</td> <td>X0002</td> <td>Summary</td> <td></td> </tr> <tr> <td>4</td> <td>X0003</td> <td>Summary</td> <td></td> </tr> <tr> <td>5</td> <td>X0004</td> <td>Summary</td> <td></td> </tr> </tbody> </table> <p>(2) Select the [Edit] menu - [Add Alarm] command, or click on the  icon.</p> <p>(3) After entering the necessary settings, click on the  button.</p> <p>If the same number already exists, the system asks if each file must be overwritten. If you select , the desired file will be overwritten. If you select , the desired file will not be overwritten, and the system will ask about the next alarm. If you select , all existing alarms will be overwritten. If you select , you will return to the menu screen.</p> <div style="border: 1px solid black; padding: 5px; margin-bottom: 10px;"> <p>Add Basic Alarm</p> <p>Start Address: d0001+1 Alarm Type: <input checked="" type="radio"/> Alarm Summary <input type="radio"/> Alarm Message</p> <p>Number of Bits to Add: 16</p> <p>Add Offset: 1</p> <p><input type="checkbox"/> Message</p> <p>Message Color: Fg: [Color Selection] Bg: [Color Selection]</p> <p>Print: <input type="checkbox"/> Trigger Time Printed <input type="checkbox"/> Print Recovery Times</p> <p>Buttons: OK, Cancel, Help</p> </div> <div style="text-align: center; margin-bottom: 10px;">  </div> <div style="border: 1px solid black; padding: 5px;"> <p>Confirm Alarm Replace</p> <p>Alarm No 5 already exists! Overwrite?</p> <p>Buttons: Yes, Yes to All, No, No to All</p> </div>	Line	Start Address	Type	Message	1	X0010	Bulletin	Tank A Temperature UP	2	X0001	Summary		3	X0002	Summary		4	X0003	Summary		5	X0004	Summary		<p>If a symbol is specified for the start address, the added addresses will be displayed as follows:</p> <p>Example: Assume that the start address is TEST (← Symbol), and that the number of added bits is 4. The addresses are consecutively added as shown below:</p> <pre>TEST TEST + 1 TEST + 2 TEST + 3</pre> <p>Set the address adding increment between 0 and 255.</p>
Line	Start Address	Type	Message																						
1	X0010	Bulletin	Tank A Temperature UP																						
2	X0001	Summary																							
3	X0002	Summary																							
4	X0003	Summary																							
5	X0004	Summary																							

■ **Changing Alarm Attributes**

You can easily change any alarm’s attributes. The dialog box that appears will vary depending on the alarm type selected.

◆ **Alarm Message/Summary**

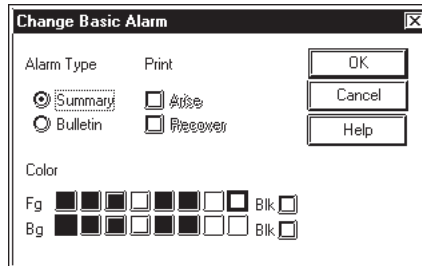

◆ **Bit Alarm Log**

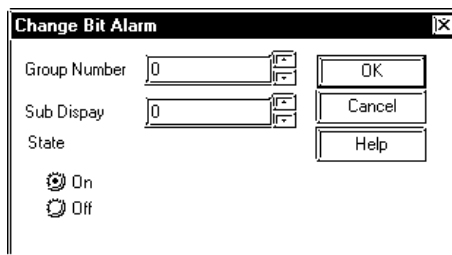

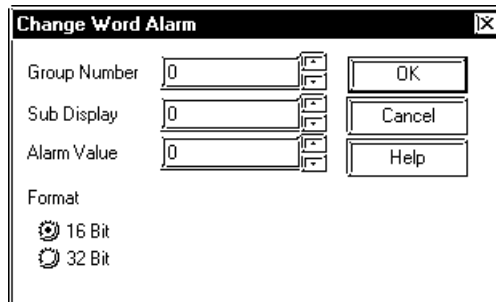

◆ **Word Alarm Log**

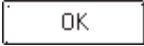
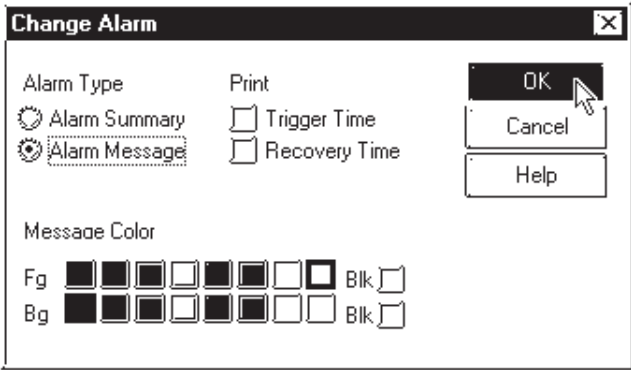

PROCEDURE	REMARKS																								
<p>(1) Select the line of the alarm to be changed. In this example, we will change an attribute of an item in the alarm message/alarm summary area.</p> <table border="1"> <thead> <tr> <th></th> <th>Bit Address</th> <th>Type</th> <th>Message</th> </tr> </thead> <tbody> <tr> <td>1</td> <td>X00010</td> <td>Bulletin</td> <td>Tank A temperature UP</td> </tr> <tr> <td>2</td> <td>X00050</td> <td>Summary</td> <td>Tank B temperature UP</td> </tr> <tr> <td>3</td> <td>X00051</td> <td>Summary</td> <td>Tank C temperature UP</td> </tr> <tr> <td>4</td> <td>X00052</td> <td>Summary</td> <td></td> </tr> <tr> <td>5</td> <td>X00053</td> <td>Summary</td> <td></td> </tr> </tbody> </table> <p>(2) Select the [Edit] menu - [Change Attributes] command, or click on the  icon.</p> <p>(3) After entering the necessary items, click on the  button.</p> 		Bit Address	Type	Message	1	X00010	Bulletin	Tank A temperature UP	2	X00050	Summary	Tank B temperature UP	3	X00051	Summary	Tank C temperature UP	4	X00052	Summary		5	X00053	Summary		<p>If several lines are selected, the attributes of the selected lines can all be simultaneously changed.</p> <p>To select several lines, drag the mouse between the desired lines, or click on the desired line while pressing the Shift or Ctrl key.</p>
	Bit Address	Type	Message																						
1	X00010	Bulletin	Tank A temperature UP																						
2	X00050	Summary	Tank B temperature UP																						
3	X00051	Summary	Tank C temperature UP																						
4	X00052	Summary																							
5	X00053	Summary																							

■ Reflecting Device Comments

This feature is used to reflect all the comment information corresponding to a selected device in the Message field.

PROCEDURE	REMARKS																				
<p>(1) Select an alarm for which comment information is to be reflected, on a row basis. Here, reflect the comment in the device for the alarm message/alarm summary.</p> <table border="1"> <thead> <tr> <th></th> <th>Bit Ad...</th> <th>Type</th> <th>Message/Summary Text</th> </tr> </thead> <tbody> <tr> <td>1</td> <td>X00100</td> <td>Summary</td> <td></td> </tr> <tr> <td>2</td> <td>X00101</td> <td>Summary</td> <td></td> </tr> <tr> <td>3</td> <td>X00102</td> <td>Summary</td> <td></td> </tr> <tr> <td>4</td> <td>X00010</td> <td>Summary</td> <td></td> </tr> </tbody> </table>		Bit Ad...	Type	Message/Summary Text	1	X00100	Summary		2	X00101	Summary		3	X00102	Summary		4	X00010	Summary		
	Bit Ad...	Type	Message/Summary Text																		
1	X00100	Summary																			
2	X00101	Summary																			
3	X00102	Summary																			
4	X00010	Summary																			
<p>(2) Select the [Edit] menu - [Apply Device Comment] command, or click on the  icon.</p>																					
<p>(3) A confirmation dialog box appears. Click on the <input type="button" value="Yes"/> button to execute the command</p> <div style="border: 1px solid black; padding: 5px; width: fit-content;"> <p>Alarm Editor [X]</p> <p> The selected Address(es) will be used to search for a related Device Comment(s). If found, the comment will be inserted into message field. Are you OK?</p> <p><input type="button" value="Yes"/> <input type="button" value="No"/></p> </div>																					
<p>(4) The device comment corresponding to the address will be included in the messages.</p> <table border="1"> <thead> <tr> <th></th> <th>Bit Ad...</th> <th>Type</th> <th>Message/Summary Text</th> </tr> </thead> <tbody> <tr> <td>1</td> <td>X00100</td> <td>Message</td> <td>! MACHIN STOPPED</td> </tr> <tr> <td>2</td> <td>X00101</td> <td>Summary</td> <td>! MACHIN STOPPED</td> </tr> <tr> <td>3</td> <td>X00102</td> <td>Summary</td> <td></td> </tr> <tr> <td>4</td> <td>X00010</td> <td>Summary</td> <td></td> </tr> </tbody> </table>		Bit Ad...	Type	Message/Summary Text	1	X00100	Message	! MACHIN STOPPED	2	X00101	Summary	! MACHIN STOPPED	3	X00102	Summary		4	X00010	Summary		
	Bit Ad...	Type	Message/Summary Text																		
1	X00100	Message	! MACHIN STOPPED																		
2	X00101	Summary	! MACHIN STOPPED																		
3	X00102	Summary																			
4	X00010	Summary																			

5.1.4 Alarm Import/Export

The created Alarm data can be exported to and saved as an ALA or CSV file. Then, by importing the saved alarm data, it can be shared among Projects. CSV files created via a text editor or Microsoft Excel can be imported and used on the Alarm Editor. Alarm data's CSV file formats are as follows:

"Block", "1"	Block designation status	
"Block1", "0"	Block 1 attributes	
"Block2", "1"	Block 2 attributes	
"Block3", "2"	Block 3 attributes	
"Basic Alarm"	Message/Summary settings	
"M0064", "Function A in suspension", "0", "0", "7", "0", "0", "0"		"Bit Address", "Message" "Printing status", "Fg", "Blk", "Bg", "Blk"
"M0065", "Function B in suspension", "1", "1", "1", "1", "2", "1"		
"M0066", "Function C in suspension", "2", "0", "3", "0", "5", "1"		
"Bit Log1"	Bit log alarm Block 1 settings	
"M0351", "Tank A: Abnormal pressure", "0", "0", "0"		"Bit Address", "Mes- sage", "Group No.", "Sub-display Screen", "State"
"M0352", "Tank B: Abnormal pressure", "768", "8999", "1"		
"Bit Log2"	Bit log alarm Block 2 settings	
"M0353", "Tank C: Abnormal pressure", "0", "0", "0"		
"M0354", "Tank D: Abnormal pressure", "768", "8999", "1"		
"Bit Log3"	Bit log alarm Block 3 settings	
"M0355", "Tank E: Abnormal pressure", "0", "0", "0"		"Word Address", "Message", "Group No.", "Sub-display Screen", "Alarm Value", "Number of Monitor Bits"
"M0356", "Tank F: Abnormal pressure", "768", "8999", "1"		
"Word Log1"	Word log alarm: Block 1 settings	
"R00101", "Tank A: Water level low", "0", "0", "0", "0"		
"R00102", "Tank B: Water level low", "768", "8999", "65535", "1"		
"Word Log2"	Word log alarm: Block 2 settings	
"R00103", "Tank C: Water level low", "0", "0", "0", "0"		
"R00104", "Tank D: Water level low", "768", "8999", "65535", "1"		
"Word Log3"	Word log alarm: Block 3 settings	
"R00105", "Tank E: Water level low", "0", "0", "0", "0"		
"R00106", "Tank F: Water level low", "768", "8999", "65535", "1"		



• CSV Import

GP Settings	Data	Operation
64-color	63 or less	Normal import
256-color	64 or more	Import with color setting: 0 to 255

• CSV Export

GP Settings	Data	Operation
64-color	63 or less	Normal export
256-color	64 or more	Export with blink setting: 0 to 255 Export with blink setting 0: Not blink

Block Designation Status	0: Specified 1: Not specified	
Block Attributes	0: Active 1: History 2: Log	
Printing Status	0: When Alarm is triggered, OFF/When recovered, OFF 1: When Alarm is triggered, ON/When recovered, OFF 2: When Alarm is triggered, OFF/When recovered, ON 3: When Alarm is triggered, ON/When recovered, ON	
Message Colors	Foreground color (Fg) Background color (Bg)	8-color compatible models: 0 to 7 64-color compatible models: 0 to 63 256-color compatible models: 0 to 255
	Blink (Blk)	Non-supporting model 0: Not blink 1: Blink 2: Not blink 3: Blink Supporting model 0: Not blink 1: Middle speed 2: High speed 3: Low speed
Group No.	0 to 768 (GP2000 series: 0 to 2012)	
Sub-display Screen	0 to 8999	
Alarm Value	Number of Monitor Bits: 16 : 0 to 65,535 Number of Monitor Bits: 32 : 0 to 4,294,967,295	
Number of Monitor Bits	0: 16 bits 1: 32 bits	

■ Alarm Export

Alarm data is saved as ALA or CSV files.

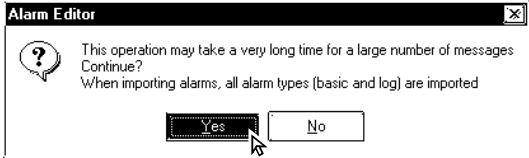
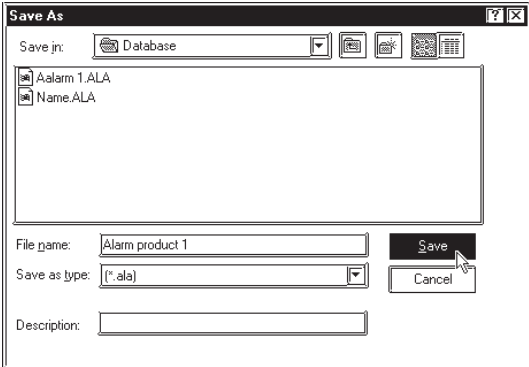
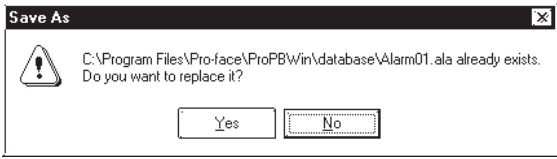
PROCEDURE	REMARKS
<p>(1) Select the Alarm Editor's [Alarm] menu - [Export] command.</p> <p>(2) Click on the <input type="button" value="Yes"/> button.</p>  <p>(3) Specify the file name and file type (*.ALA or *.CSV) with which the exported alarm data is saved, and click on the <input type="button" value="Save"/> button.</p> <p>Enter a comment, if desired.</p> <p>If the same ALA file name already exists, the system asks if the existing file must be overwritten. If it must be overwritten, select <input type="button" value="Yes"/>. If it should not be overwritten, select <input type="button" value="No"/>.</p>  <p style="text-align: center;">↓</p> 	<p>All the setting information of Alarm Message/Summary, Bit Log Alarm, and Word Log Alarm is saved in the exported file.</p>

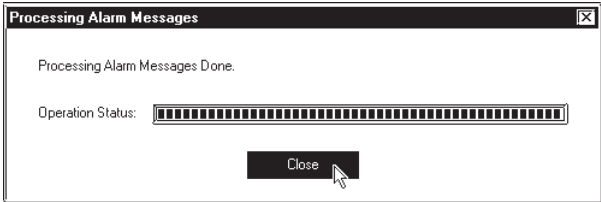
PROCEDURE	REMARKS
<p>(4) Click on the  button to quit the Alarm export mode.</p> 	

■ Alarm Import

Alarm data saved as a file is imported to the currently open Alarm Editor. Files with the extension of “*.ALA” or “*.CSV” can be imported.

To import alarm data from a CSV file, only the specified type of alarm can be imported from all the registered alarm.

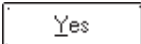
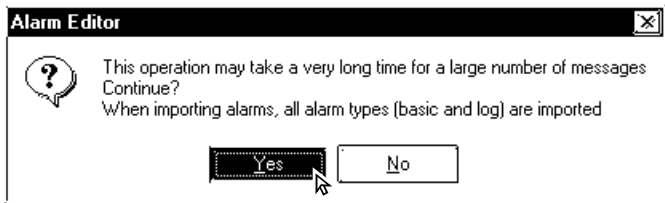
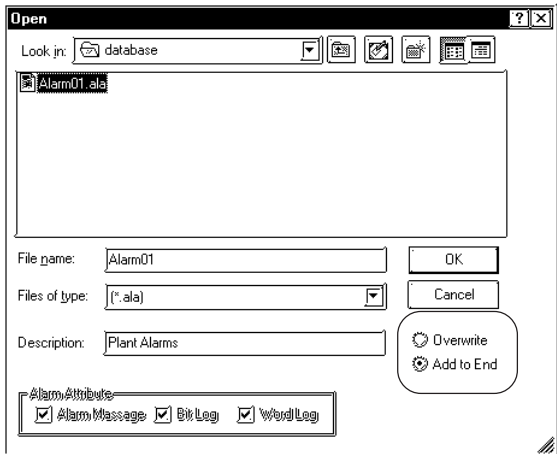
PROCEDURE	REMARKS
<p>(1) Select the Alarm Editor’s [Alarm] menu - [Import] command.</p> <p>(2) Click on the  button.</p>  <p>(3) Select a file (*.ALA or *.CSV) to be imported, or enter the file name. Then, specify an import method.</p> 	<p>[Overwrite] All current alarm registration numbers (1 to 8999) will be overwritten.</p> <p>[Add to End] Imported messages will be added after the last message line. If there are any gaps between the current registration numbers, the sequence numbers will be re-assigned to fit into all existing lines, and the imported messages will be added after the last line.</p>

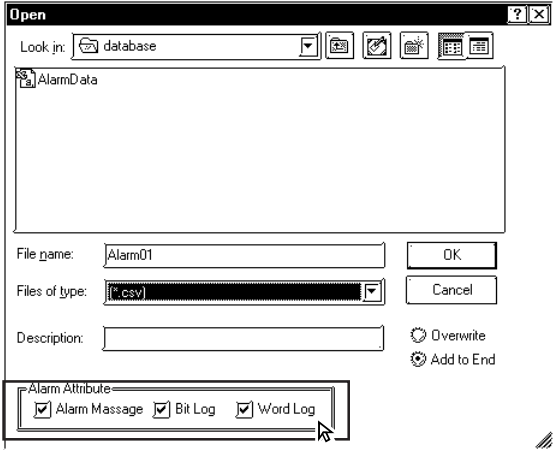
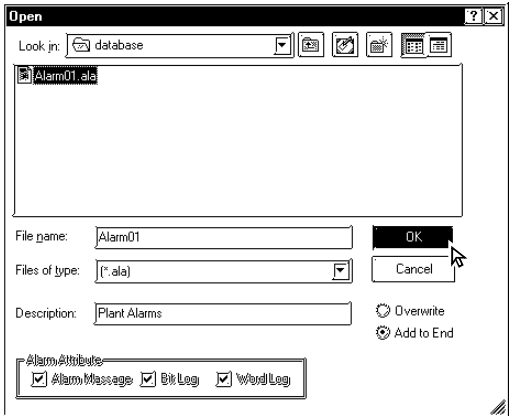
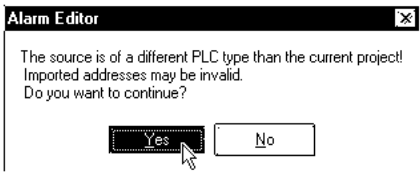
PROCEDURE	REMARKS
<p>(4) When selecting CSV file as imported file type, specify the type of alarm to be imported. Only the type of alarm specified here will be imported.</p>  <p>(5) After entering all the necessary items, click on the <input type="button" value="OK"/> button. If the selected Device/PLC type is different between the currently open project and the imported ALA file, the system asks if the preset addresses should be overwritten. If the preset addresses must be overwritten, select <input type="button" value="Yes"/>. If they must not be overwritten, select <input type="button" value="No"/>.</p>  <p style="text-align: center;">↓</p> 	<p>When selecting ALA file as imported file type, skip step (4).</p> <p>Once you complete the [Import] command, it cannot be undone.</p>

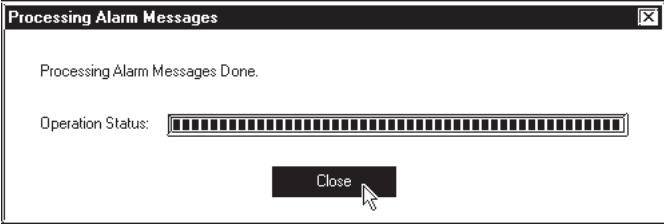
PROCEDURE	REMARKS
<p>(6) Click on the  button to quit import mode. Since you selected [Add to End] in this example, the imported messages were added after the last line.</p> 	



- **When alarm data does not have an identifier "Block*" for the first 4 lines, which indicates block settings, the alarm will not be imported.**

- **If the address(es) registered in the alarm data to be imported are incorrect, set correct addresses via the Symbol Editor.**

Reference 4.7 Symbol Editor

- **When the number of message characters exceeds the limit, the message is imported only for the effective number of characters.**

- **When data is imported from a file in which only a message is registered, the initial value is used as an address.**

Memo

6

GP INITIAL AND SYSTEM SETTINGS

You can select many of the GP unit's initial settings through the GP-PRO/PB III for Windows program. This program area is called "System Settings". When "System Settings" data is sent to the GP unit, you will not need to manually perform the initial setup of the GP unit. A description of each GP unit setting item is provided in your "GP Series User's Manual" (sold separately). For details, refer to that manual.

6.1Menu Setting Items: GP Setup

6.1 Menu Setting Items: GP Setup

In the [System Settings] mode, you can easily select the GP unit's initial settings. By doing this, you don't need to manually set up the GP panel, since the [System Settings] data is sent to the GP panel automatically. After the [System Settings] data is sent to the GP panel, you can also change those settings via the GP unit itself.

Reference *GP Series User's Manual (sold separately), Chapter 5: INITIALIZE*

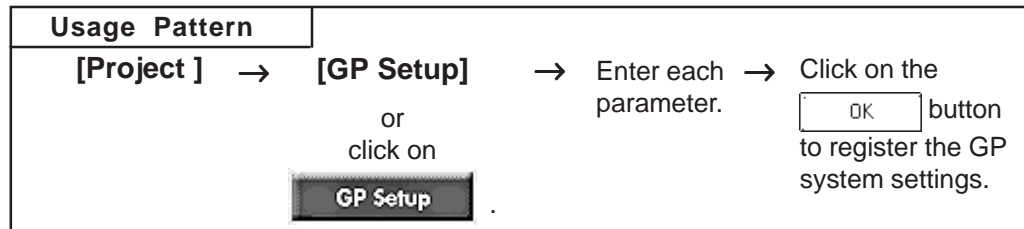

Some setting commands are supported by the GP unit but not by GP-PRO/PB III for Windows, or vice versa, i.e. are supported by GP-PRO/PB III for Windows but not supported by the GP unit. This section describes only the commands supported by GP-PRO/PB III for Windows. For a description of other commands, refer to your "GP Series User's Manual" (sold separately). For a description of the network setting, refer to the Device/PLC Connection Manual.

◆ Setting commands Supported by Only the GP Unit:

- Setting Date/Time
- Self-diagnosis command
- Font settings (English, Korean, etc.)*¹
- Functions for adjusting the Video Display

◆ Commands Supported by Only GP-PRO/PB III:

- **Initial Screen Settings: [Color Setting] dialog**
- **GP Settings: [Checksum]**
Enables checksum verification.
- **GP Settings: [Buzzer]**
Select continuous or intermittent buzzer output.
- **GP Settings: [Screen Level Change Flow]**
Used to switch screens in the hierarchical display mode.
- **GP Settings: [Change to Screen No.]**
Specify the number of the screen used to replace the current one after the preset standby time has passed. If you enter "0", no screen will be displayed.
- **I/O Settings: [Offline Mode]**
Specify how to change from on-line mode to offline mode.
- **Mode Settings: [Device/PLC Type]**
Displays the name of the host (PLC) connected to the GP panel.

*1 If any font setting other than "Japanese" is selected, "Font Setting" requires specifying whether alphanumeric characters and symbols are to be displayed at the high quality level.

- **Mode Settings: [Option]**
This setting is necessary only when specific Device/PLC types are selected.
- **Extended Settings: [K-tag Priority]**
Designates the K-Tag processing mode. “Standard” mode executes the K-tag once per scan time, and “Twice” mode executes the K-tag two times per scan time.
- **Extended Settings: [Backup Settings]**
Used to back up the GP unit's LS area data. Specify the initial address of the backup range, and the number of words used.
- **Extended Settings: [Delete Error Display](Only for programless type)**
Displays an error message when an communication error occurs with the GP, and deletes the error message when the communication error is reset. System errors however cannot be reset, regardless of this setting.
- **Extended Settings: [Watch Dog]**
Monitors the communication status between the GP and a PLC. The GP unit writes the data (00FFh) to the word address of the PLC at specified time intervals. (Specify in the range of 0 to 65535 seconds. The Watch Dog function is disabled when "0" is specified.) This function enables the PLC to check the communication states with the GP by periodically monitoring the data (00FFh) written by the GP. After the data are reviewed by the PLC, execute the "0 Clear" command to clear the data and allow for monitoring of new data written by the GP unit.
- **Extended Settings: [CF Card Data Storage Settings]**
Used to specify a control word address when saving data on the CF Card for the GP-77R and GP2000 series. The GP unit writes this control word address data to the CF card.
- **Extended Settings: [Available CF Card Space]**
When using a CF Card on the GP77R and GP2000 Series, specify the address to store the information on available CF card space.
▼Reference▲ Tag Reference Manual, 4.4 Using the CF Card
- **Extended Settings: [Q-tag Settings]**
When using a Q-tag, specify display and printing settings as well as extended settings.
▼Reference▲ Tag Reference Manual, 2.20 Q-tag (Alarm Summary Display)
- **Extended Settings: [Capture Settings]**
Designates the settings for the Control Word Address used for producing hard copies of the GP screen displaying video images.
▼Reference▲ Tag Reference Manual 4.4.9 Screen Capture
- **Extended Settings: [Video Settings] (Video Window Operation Settings)**
Settings used for displaying a video window as a global window
▼Reference▲ 3.6.2 Video Window Settings
- **Extended Settings: [FEP Setting]**
- **Extended Settings: [Serial 2-D code reader]**
(includes LS storage start address/Read complete bit address/Data storage settings)

• **Communication Settings: [Send Wait]**

If the GP unit sends a command to the PLC immediately after receiving a response from the PLC, the PLC cannot receive the command, which will cause a communication error, depending on the Device/PLC type. In this case, enter a value for the transmission wait time. If a transmission wait time has been entered, the GP unit waits for the preset time duration after receiving the PLC's response, and then sends the next command to the PLC.

■ **Tab Setting Items**

Each tab's setting items are described here.



Note: The setting items may differ depending on the GP type or Device/PLC type being used.

◆ **GP Settings**

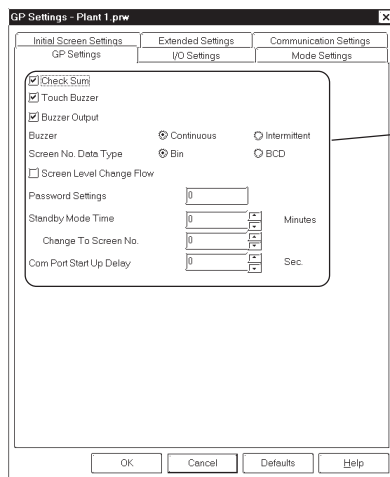

System Setting Items

◆ **I/O Settings**

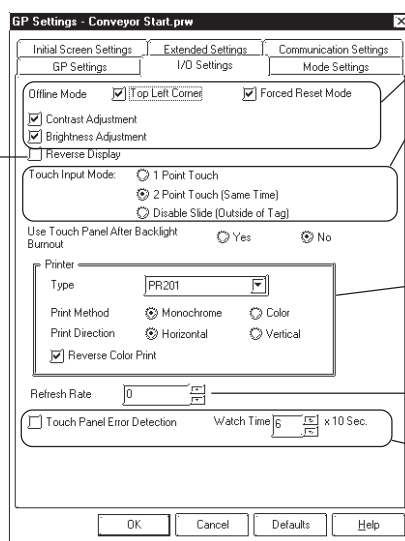

Touch Panel Settings

LCD Settings (for the GP-H70L, GP-270L, GP-370L, GP-377L, GP-2301HL, GP-2300L and GP-2301L only)

Printer Settings ("Vertical printing" is possible only with the GP-675, and GP-2600)

Frame Refresh Rate Settings (GP-377, GP-577RS only)

Sets up the function for detecting errors in Touch Panel operation (available only with the GP77R and GP2000 series).

◆ Mode Settings

Operating Environment Settings

Node Information Settings

Customizing command (n:1)

Operating Environment Options

◆ Initial Screen Settings

Initial Screen Settings

[64 color with Blinking] is the default setting.
 GP2000 series only (except GP-2301HS, GP-2301HL, GP-2300L, GP-2301L, GP-2301S and GP-2501S series units)

◆ Extended Settings

Font Settings

K-tag Processing Frequency Settings

Watchdog Monitoring Address and Time Settings

Control Address Settings for Saving CSV Data such as Alarm Screens on CF Card (GP77R (except GP-377) series and GP2000 series only)
 ▼ **Reference** Tag Reference Manual, 4.4.8 ■ Specifying a Control Address

System Area Backup Command Settings

GP Internal Memory Data Area Settings

Global Window Settings

Video Environment and Display Settings

Settings for capturing the GP screen ▼ **Reference** Tag Reference Manual, 4.4.9 Screen Capture

Alarm History Display Mode Settings

Handy-type GP's Operation Switch (Enable/Disable) Settings

FEP Settings

Serial Code Reader

Extend SIO Settings

Designates the address to store the information on available CF card space (only supported by the GP77R (except GP-377) and GP2000 series).
 ▼ **Reference** Tag Reference Manual, 4.4 Using the CF Card

◆ Communication Settings Menu

Communication Parameter Settings
 115200 and 57600 can be selected for the GP77R and GP2000 series only.

Communication Monitor Time Settings

■ GP System Settings

PROCEDURE	REMARKS
-----------	---------

(1) Via the Project Manager, select the [Screen/Setup] menu - [GP System Settings] command, or click on the  icon.

(2) Click on a desired menu tab.
Each tab's setting items will be displayed.

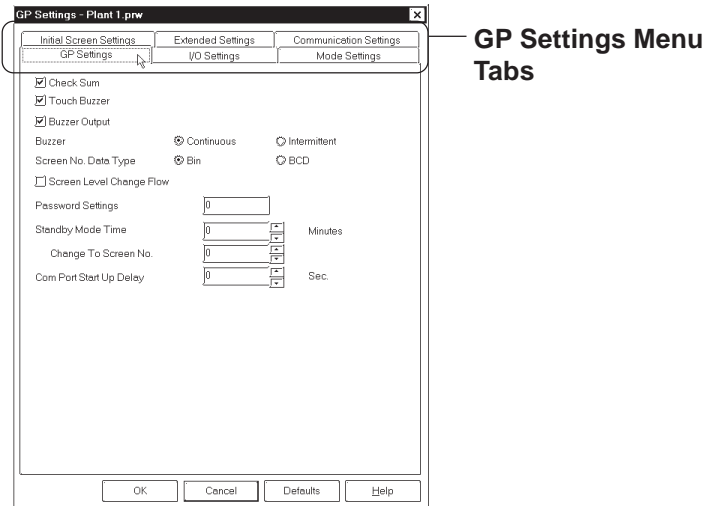

(3) After entering all the necessary items, click on the  button.

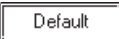
To reset each item to its default value, click on the  button.

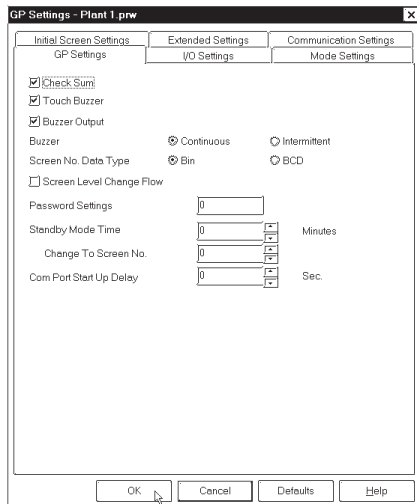

Memo

To display screens created with GP-PRO/PB III on the GP unit, you must first transfer the screen data to the GP. Conversely, with the GP-PRO/PB III program, you can also transfer screen data stored in the GP unit back to your personal computer for additional editing.

This chapter describes how to transfer screen data to and from the GP unit.

7.1 Prior to Transferring Data
7.2 Transferring Screens
7.3 Options
7.4 Setting Up Your GP via an Ethernet Network

7.1 Prior to Transferring Data

7.1.1 GP Screen Transfer Cable



The GP screen can be transferred in three ways; through the GP screen transfer cable, the CF card or on Ethernet connection.

You must first connect the Data Transfer Cable to the GP unit and your personal computer before you can transfer screen data.

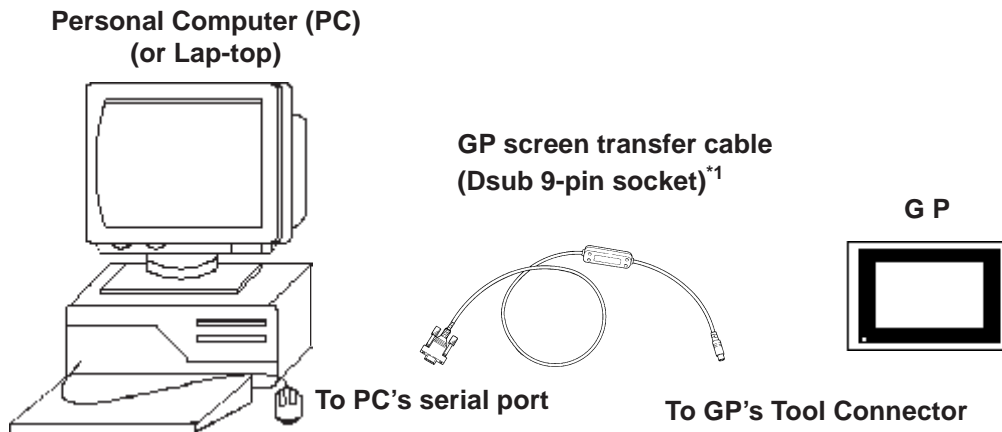

- **To transfer GP-PRO/PB III for Windows data to the GP unit, the optional cable set (GPW-CB02) is required. This cable does not come with any interface conversion adapter for the personal computer. Supply a connector conversion adapter compatible with the interface of your personal computer. Such an adapter is available at a computer supplies shop.**
- **To transfer Filing Data, image screens, sound data, etc. to a CF card on the GP77R series, the Multi Unit (sold separately) and a CF card are required.**
- **File Transfer requires approximately three times the hard disk space occupied by the Project file.**





- **If a serial mouse is used, be sure to connect the cable from the GP unit to a different serial port on your PC.**

7.2 Transferring Screens

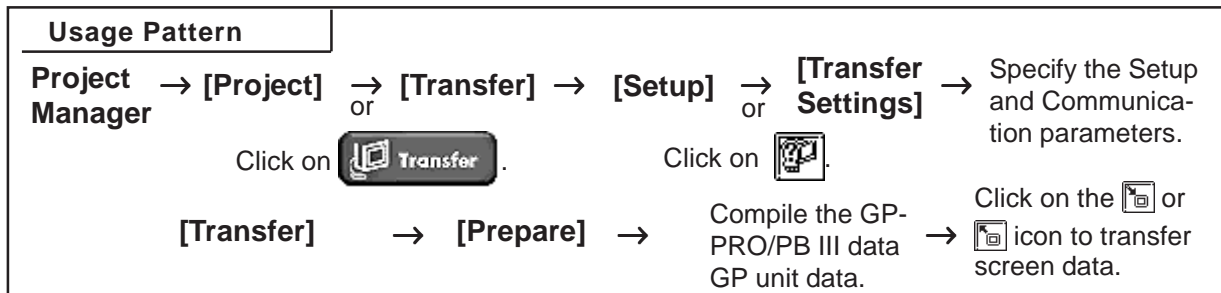
This section describes how to transfer screen data created with the GP-PRO/PB III program to and from the GP unit.



To display a screen (window) to perform data transfer, select the Project Manager's [Project] menu - [Transfer] command, or click on the  icon. Or, select the Screen Editor's [Screen] menu - [Transfer] command, or click on the  icon. An example of this screen (window) is as follows:

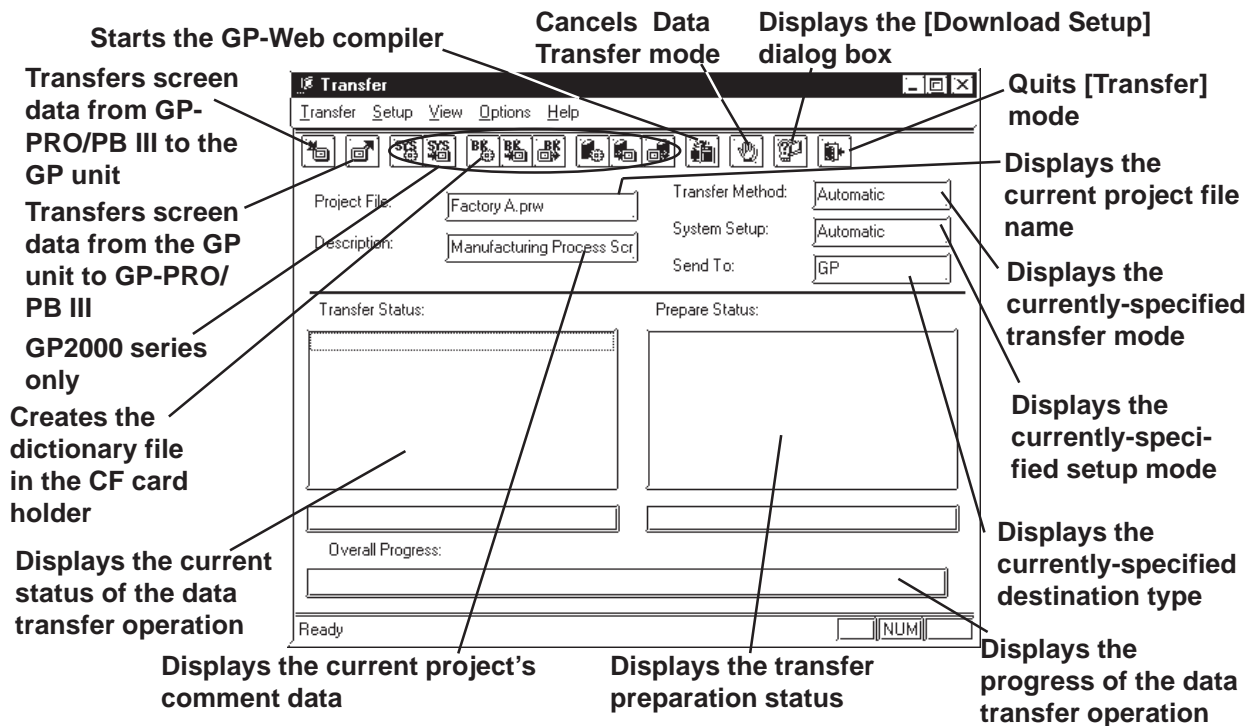

The tool bar icons provide the following functions:

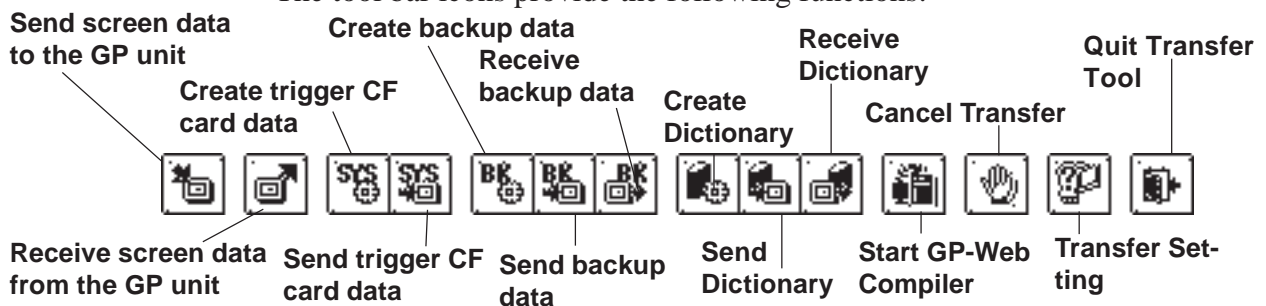

Do not turn OFF the PC or the GP unit, nor disconnect the transfer cable during the transfer of screen data. This can cause an error when the GP is started.

7.2.1 Transfer Settings

This section describes the parameter settings necessary for screen data transfer between your personal computer and the GP unit. These parameters must be reset if your personal computer has been disconnected from the GP unit, if the GP unit has been shut down, or if a nonstandard system or protocol program has been used with the GP unit.

Transfer Settings

Select the [Setup] menu - [Transfer Settings] command, or click on the  icon. Then, a dialog box to perform data transfer settings will appear.

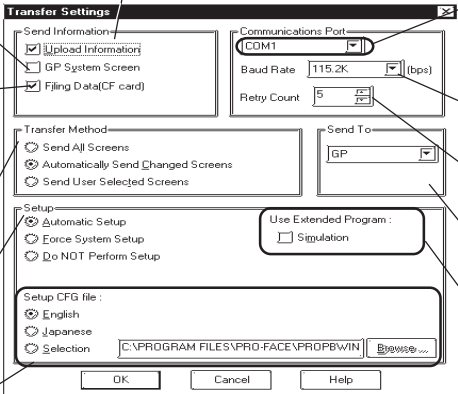

Specify the information to be transferred with the screen data here.

Transfers Filing Data to the CF card.

Reference
Tag Reference Manual, 4.4 Using the CF Card

Select the transfer mode

Select the setup mode

Select the setup CFG file

Specify whether to transfer the upload information required to Receive data from the GP unit

Select the PC serial port that will be used with the data transfer cable

Select a transfer speed.

Select the maximum number of transfer retries

Select the destination type

Sends the simulation protocol to the GP unit.

Reference 8.1 Overview

Transfer Mode

Send Information

Upload Information

GP System Screen

Filing Data(CF card)

Upload parameter data

Specify whether to send the upload parameter data in order to receive the data from the GP.



Important

Upload parameter data must be included to Receive screen data from the GP unit. If the GP unit's memory is insufficient to include the upload parameter data, screen data can still be transferred from your personal computer to the GP unit. However, if the upload parameter data is omitted, your personal computer cannot receive screen data from the GP unit.

GP System Screen

Specify whether to transfer the GP system data when sending the data to GP.

Filing Data (CF Card)

Specify to transfer the filing data to CF card.

Reference *Tag Reference Manual 4.4 Using the CF Card*

◆ **Serial Port**

Select the serial port for connecting the transfer cable, Transfer Speed and the maximum number of transfer retries.

◆ **Transfer Method**

Transfer Method
<input type="radio"/> Send All Screens
<input checked="" type="radio"/> Automatically Send Changed Screens
<input type="radio"/> Send User Selected Screens

Send All Screens

Transfers all screen data in a Project File to the GP unit.

Automatically Send Changed Screens

Any screens that have been updated in the current Project File are automatically transferred to the GP unit. This transfer mode is only effective when screens have been previously transferred to the GP unit.



Note: When “Automatically Send Changed Screens” is used, screens that have been deleted (not just updated) from the Project File in the GP-PRO/PB III program will not be automatically deleted from the Project File stored in the GP unit. To completely replace all screens of the Project File stored in the GP unit, be sure to use “Send All Screens”. However, the data on the CF card is not deleted even if "Send All Screens" is selected. To delete data from a CF card, initialize it.

Reference *Each Multi Unit's User Manual*

Send User Selected Screens

When transferring a screen to a Project File stored in the GP unit, you must specify the screen type.



Note: No Filing Data, logged data and sound data can be specified to transfer them.

To select screens, click on the names of desired screens while holding down the **Ctrl** key.

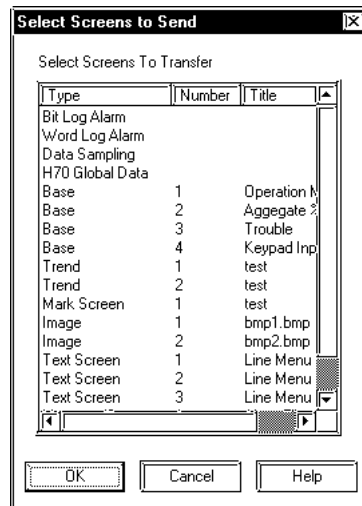

◆ **Send To**

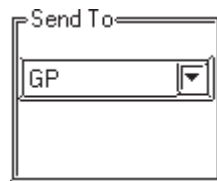

“GP”:

Screen data is transferred from GP-PRO/PB III to the GP unit.

“Memory Loader”:

Screen data is transferred from GP-PRO/PB III to the Memory Loader II.

Reference *Memory Loader II Operation Manual (included with the Memory Loader II unit)*

“Ethernet”:

This designation type can be selected only when your PLC is the “Memory Link Ethernet” type or when you are using the 2-way Driver.

Reference *7.2.3 2-Way Driver*

Reference *GP70 Series Memory Link Handshaking Protocol Manual (for the GP Ethernet I/F unit) (sold separately), Pro-Server with Pro-Studio for Windows Operation Manual*



- When Device/PLC type is "memory link Ethernet", screen data cannot be transferred to a CF card.
- When Device/PLC type is "memory link Ethernet" and you wish to transfer the screen data via Ethernet, select the [Do not perform Setup].

◆ Setup

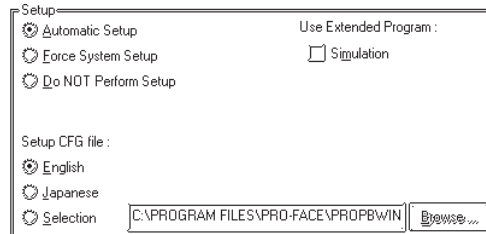

Automatic setup :

Set up operation is performed if necessary, according to the GP's status. Normally, select this setup mode.

Force system setup :

Setup operation is performed every time screen data are transferred, regardless of the GP's status.

Do not setup :

Setup operation is not performed, and only screen data are transferred.

Setup CFG file :

This is the file storing the setup information. Normally, you need not use this setup mode.

If you select "English" and perform setup, the OFFLINE screen on the GP unit will be displayed in English.



If you have changed from Japanese to English or vice versa, be sure to force the system setup.

7.2.2 Passwords

■ Registering a Password

You can enter a password to restrict user access to the screen transfer function.











- **Be sure to keep a copy of the password in a safe place. If you forget the password, the “Transfer” function cannot be executed.**
- **The password is limited to 24 characters and only alphanumeric data (no symbols) can be used.**

PROCEDURE	REMARKS
<p>(1) Via the Project Manager, select the [Project] menu - [Transfer] command, or click on the icon. Or, via the Screen Editor, select the [Screen] menu - [Transfer] command, or click on the icon.</p> <p>(2) Select the [Setup] menu - [Password] command.</p> <p>(3) Enter a password.</p> <div style="border: 1px solid black; padding: 5px; margin: 5px 0;"> <p>Register Password</p> <p>Please Enter Password: <input style="width: 100%;" type="password"/></p> <p>Please Confirm Password: <input style="width: 100%;" type="password"/></p> <p><small>Warning: Please remember to write down your password! If you forget your password, screen transfer cannot be performed.</small></p> <p style="text-align: right;"> <input type="button" value="OK"/> <input type="button" value="Cancel"/> <input type="button" value="Help"/> </p> </div> <p>(4) Enter the same password again for confirmation, and then, click on the <input style="width: 40px;" type="button" value="OK"/> button.</p> <div style="border: 1px solid black; padding: 5px; margin: 5px 0;"> <p>Register Password</p> <p>Please Enter Password: <input style="width: 100%;" type="password"/></p> <p>Please Confirm Password: <input style="width: 100%;" type="password"/></p> <p><small>Warning: Please remember to write down your password! If you forget your password, screen transfer cannot be performed.</small></p> <p style="text-align: right;"> <input style="border: 2px solid black;" type="button" value="OK"/> <input type="button" value="Cancel"/> <input type="button" value="Help"/> </p> </div>	<p>If the currently open Project File has not yet been saved in stop, the system will ask you to do so before registering a password.</p> <div style="border: 1px solid black; padding: 5px; margin: 5px 0;"> <p>New</p> <p style="text-align: center;">? Do you want to save new project ?</p> <p style="text-align: center;"> <input type="button" value="Yes"/> <input type="button" value="No"/> </p> </div> <p>Also, if the currently edited screen has not been saved via the Screen Editor, a prompt will appear asking if screen data is saved before transfer.</p> <div style="border: 1px solid black; padding: 5px; margin: 5px 0;"> <p>Drawing Board</p> <p style="text-align: center;">? Save changes to Screen: Untitled1 ?</p> <p style="text-align: center;"> <input type="button" value="Yes"/> <input type="button" value="No"/> <input type="button" value="Cancel"/> </p> </div> <p>If a password has already been registered, the [Change Password] dialog box will appear.</p> <div style="border: 1px solid black; padding: 5px; margin: 5px 0;"> <p>Change Password</p> <p>Please Enter Password: <input style="width: 100%;" type="password"/></p> <p>Please Enter New Password: <input style="width: 100%;" type="password"/></p> <p>Please Re-enter New Password: <input style="width: 100%;" type="password"/></p> <p style="text-align: right;"> <input type="button" value="OK"/> <input type="button" value="Cancel"/> <input type="button" value="Help"/> </p> </div>

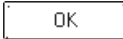
■ **Changing a Password**

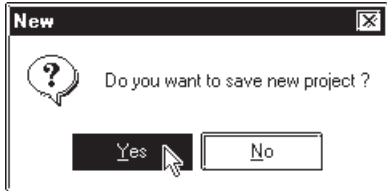
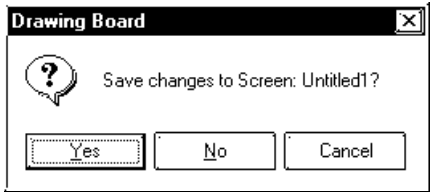
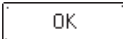
The registered password can be changed or canceled.

PROCEDURE	REMARKS
<p>(1) Via the Project Manager, select the [Project] menu - [Transfer] command, or click on the  icon. Or, via the Screen Editor, select the [Screen] menu - [Transfer] command, or click on the  icon.</p> <p>(2) Select the [Setup] menu - [Password] command.</p> <p>(3) In order to change a password, you must first enter the currently registered password.</p>  <p>(4) Enter a new password.</p>  <p>(5) Enter the same password again for confirmation, and then, click on the  button.</p> 	<p>If the currently open Project File has not yet been saved in step (1), the system will ask you to do so before registering a password.</p>  <p>Also, if the currently edited screen has not been saved via the Screen Editor, a prompt will appear asking if screen data is saved before transfer.</p>  <p>To cancel the password, after entering the currently registered password in step (2), DO NOT enter a new password in step (3) and simply click on the  button.</p> 

7.2.3 2-Way Driver

The 2-Way feature provides a system in which an upper-level (Host) computer accesses GP or PLC data via a network (Ethernet). This enables data to be exchanged regardless of the type of PLC unit(s) used. To use the 2-Way feature, the Pro-Server software and an Ethernet connector are required. All GP2000 (except GP-2301H, GP-2401H, GP-2301 and GP-2501) series units are equipped with an Ethernet interface.

Reference *Pro-Server with Pro-Studio for Windows Operation Manual*

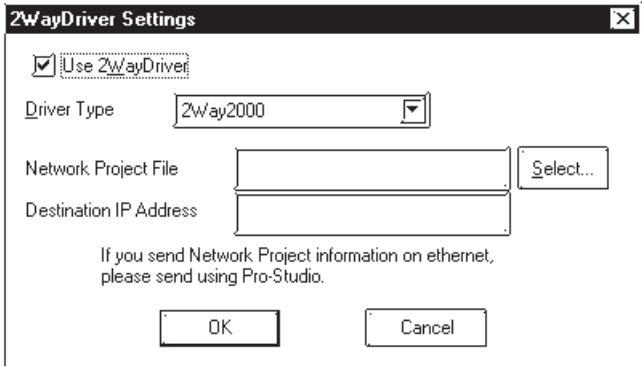
PROCEDURE	REMARKS
<p>(1) Select the Transfer area [Setup] menu's [2Way Driver] command.</p> <p>(2) Designate the 2Way Driver.</p> 	<p>Reference <i>Pro-Server with Pro-Studio for Windows Operation Manual</i></p>

7.2.4 Transfer Preparation

The Project File (PRW file) data created with the GP-PRO/PB III program is first compiled before it is transferred to the GP unit.

Select the [Transfer] menu - [Prepare] command to compile your data.

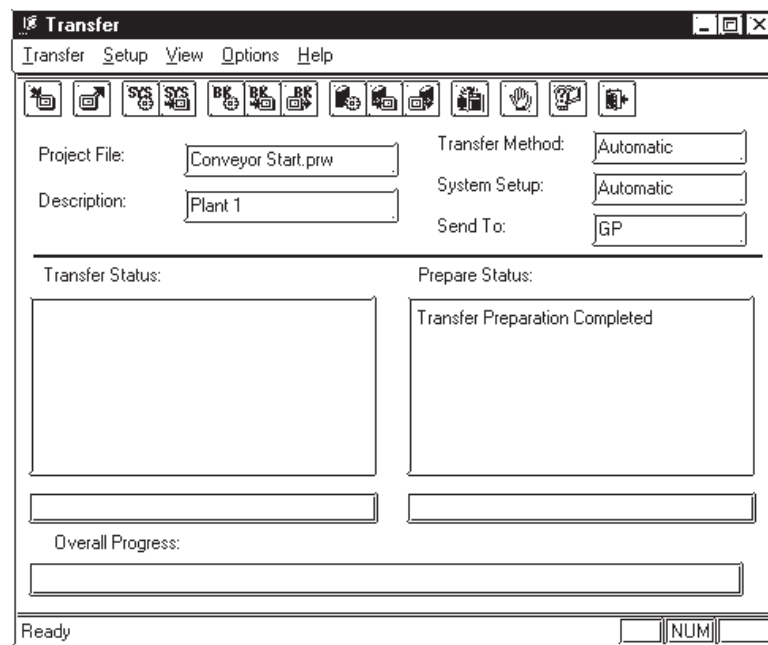

- To prepare the transfer, about the 3 times the project file size is required in your computer's hard disk.
- After the [Prepare] command is finished, you can check the GP unit's current memory capacity with the [Project Information] feature.

Reference 4.5.1 Project Information





- Once you use the [Prepare] command, you do not need to use it again for the same data, unless the data has been updated.
- If the Project File (PRW file) to be transferred is stored on your PC's floppy disk, copy it to your PC's hard disk prior to using "Prepare" to reduce transfer time.

7.2.5 When Sending Screens To the GP



To display screens created with GP-PRO/PB III program on the GP panel, you must first transfer the screen data from your personal computer to the GP unit.



If the GP unit is not connected to the PLC when the screen data are transferred to the GP unit and the “Change State” function is set to “Yes”, bit switches, toggle switches, lamps, and objects will not be displayed on the GP panel after data transfer.





PROCEDURE	REMARKS
<p>(1) Via the Project Manager, select the [Project] menu - [Transfer] command, or click on the  icon. Otherwise, via the Screen Editor, select the [Screen] menu - [Transfer] command, or click on the  icon.</p> <p>(2) Select the [Transfer] menu - [Send] command, or click on the  icon.</p> <p>If the currently open Project File has not been prepared for data transfer (the Project File has not been compiled), then the system automatically compiles the Project File before transferring it to the GP unit.</p> <p>To transfer a screen to the GP unit for the first time, set up the GP unit*1 first, and then transfer the screen data. The number of screens transferred is displayed in [Transfer Status].</p> <p>If the Device/PLC type of a screen or Project File to be transferred is different from the GP's existing internal screen type, the following message will appear. When you click on the <input type="button" value="OK"/> button, the system starts setup operation, and then transfers the screen data.</p> <div data-bbox="209 1563 539 1720"> </div> <div data-bbox="587 1563 917 1720"> </div> <p>After set up is completed, the GP panel screen is automatically switched to the OFF-LINE mode. Confirm the initial setting on the GP panel, and adjust the settings as required.</p>	<p>If the currently open Project File has not yet been saved in stop (1), the system will ask you to do so before registering a password. Select <input type="button" value="Yes"/> to save, or <input type="button" value="No"/> to not save.</p> <div data-bbox="946 936 1337 1126"> </div> <p>Also, if the currently edited screen has not been saved via the Screen Editor, a prompt will appear asking if screen data is saved before transfer.</p> <div data-bbox="946 1328 1305 1485"> </div> <p>Make sure that the GP unit is in the “Transfer Screen Data” mode or “RUN” mode. However, for the GP-377 Series or GP77R Series, when the built-in 2 port function is specified in the GP, be sure to select Transfer mode.</p> <p>Reference <i>GP Series User's Manual (sold separately): Chapter 5 Initialize</i></p> <p>To cancel the data transfer mode, click on the  icon.</p>

*1 “GP setup” means to download the system program and protocol program from GP-PRO/PB III to the GP unit so that the GP unit can operate in the specified environment.

PROCEDURE	REMARKS
<p>(3) After screen data transfer is completed, select the [Transfer] menu - [Exit] command, or click on the  icon.</p>	<p>Data transfer mode will automatically quit when the GP unit's internal memory capacity becomes insufficient.</p> <p> Important When you transfer a screen to a GP unit with a SRAM, backup data will be deleted.</p>

■ Transferring a Screen Using a Password

If a password has been registered, you must enter it to transfer data to the GP unit.

PROCEDURE	REMARKS
<p>(1) Via the Project Manager, select the [Project] menu - [Transfer] command, or click on the  icon. Or, via the Screen Editor, select the [Screen] menu - [Transfer] command, or click on the  icon.</p> <p>(2) Select the [Transfer] menu - [Send] command, or click on the  icon.</p> <p>(3) Enter the registered password, and click on the <input type="button" value="OK"/> button to confirm it. The data transfer operation will start.</p> <div data-bbox="252 1487 663 1677" data-label="Image"> </div> <p>(4) After screen data transfer is completed, select the [Transfer] menu - [Exit] command, or click on the  icon.</p>	<p>If you enter an incorrect password three times or more, data transfer cannot be performed. In this case, repeat the transfer procedure from step (2).</p> <div data-bbox="991 1379 1291 1543" data-label="Image"> </div> <p>To cancel data transfer mode, click on the  icon.</p>





7.2.6 When Receiving Data From the GP



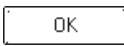
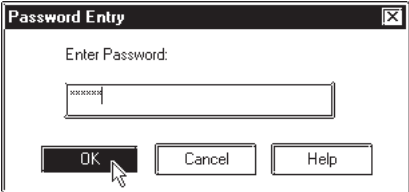

Screen data stored in the GP unit can be received on a project file basis by the GP-PRO/PB III.

To receive transferred screen data with the password registered, password entry is required when receiving the data.

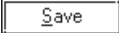

- *When screen data is created via the GP-377, GP77R or GP-2000 Series' Project File with a data transmission speed of 115,200 kbps or 57,600 bps and received from the above-mentioned GP unit and transferred to another GP unit other than the above-mentioned, this speed is automatically changed to 38,400 bps. Therefore, set the PLC's data transmission speed to 38,400 bps.*
- *Unless [Upload Information] is selected in the Transfer Settings dialog box when any screen is transferred to the GP unit, the screen cannot be received from the GP unit.*

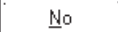
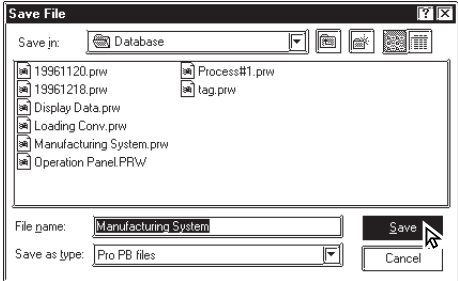
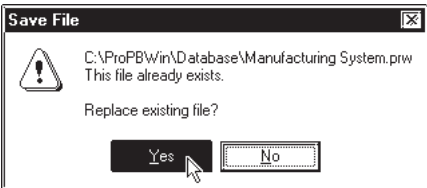
PROCEDURE	REMARKS
<p>(1) Via the Project Manager, select the [Project] menu - [Transfer] command, or click on the  icon. Or, via the Screen Editor, select the [Screen] menu - [Transfer] command, or click on the  icon.</p> <p>(2) Select the [Transfer] menu - [Receive] command, or click on the  icon.</p> <p>(3) When a password has been registered, enter it and click on the  button.</p> 	<p>When a password has not been registered, skip step (3).</p> <p>If you enter an incorrect password three times or more, data transfer cannot be performed. In this case, repeat the transfer procedure from step (2).</p> 

PROCEDURE	REMARKS
<p>(4) Specify a location (directory) and Project file to store the received data. Then, click on the  button.</p> <p>If the same Project File name already exists, the system asks if you wish to replace it; if so, select , otherwise select .</p>   <p>(5) After the data transfer is completed, select the [Transfer] menu - [Exit] command, or click on the  icon.</p>	<p>To cancel data transfer mode, click on the  icon.</p>

7.2.7 Sending/Receiving Dictionary File

This feature allows you to create, send and receive a dictionary file used in a Japanese FEP. This feature is available only with the GP2000 series.



Note: Receiving and sending via Ethernet is also available.

■ Creating a Dictionary File

Select [Create Dictionary] from the [Transfer] menu to create a dictionary.

The dictionary created (about 500KB) is written into the CF Card output folder. If a dictionary file already exists on the CF Card output folder, the following dialog box appears asking whether the existing file should be overwritten

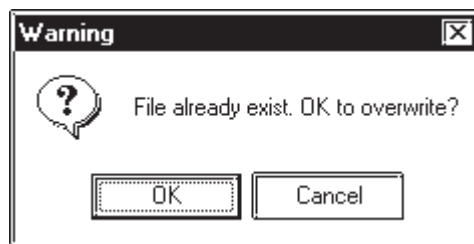

■ Sending a Dictionary File

Select [Send Dictionary] from the [Transfer] menu to create and send a dictionary file to the CF Card attached to the GP unit.

The dictionary created is written into the CF Card output folder before it is sent. If a dictionary file already exists on the CF Card output folder, the following dialog box appears asking whether a new dictionary should be created.

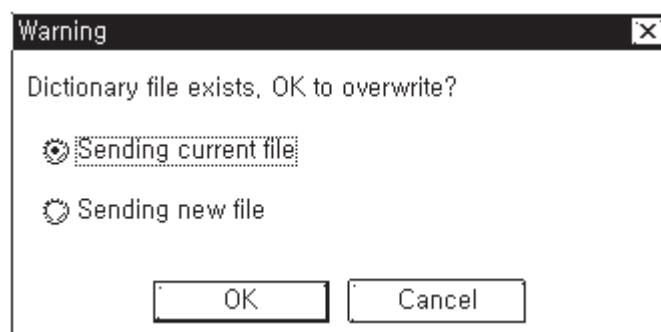

■ Receiving a Dictionary File

Select [Receive Dictionary] from the [Transfer] menu to load a dictionary file from the CF Card attached to the GP unit. The received dictionary file is loaded to the CF Card output folder. If a dictionary file already exists on the CF Card output folder, the following dialog box appears asking whether the existing file should be overwritten.

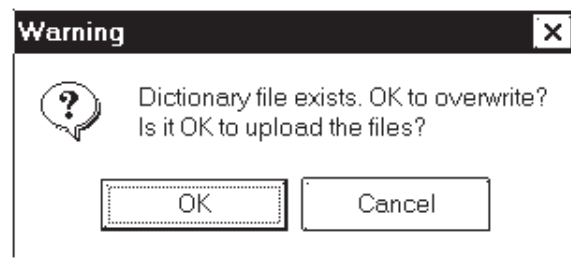

- The Receive Dictionary feature enables other GP units to use a specific dictionary file in which the list of candidates for kanji-kana conversion is sorted by the order of frequency of usage according to a learning function.
- The learning function uses the backup SRAM. Up to 1KB (about 100 words) of backup SRAM is available. If the allotted 1KB is exceeded, the data are deleted starting with the least-recently used data.

7.2.8 Start GP-Web Compiler

This feature prepares for the transfer of a Project file and activates the GP-Web Compiler.

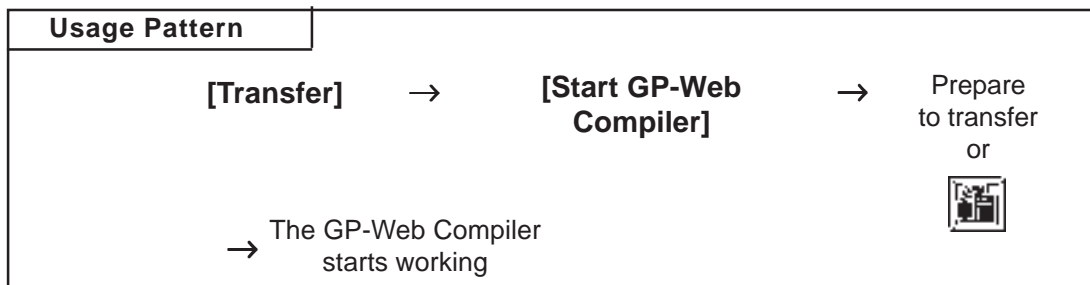

To operate the GP-Web Compiler:

Reference *GP-Web Operation Manual*

7.3 Options

In addition to transferring/receiving screen data, you can check the screen information on the connected GP Unit using the GP-PRO/PB III program.

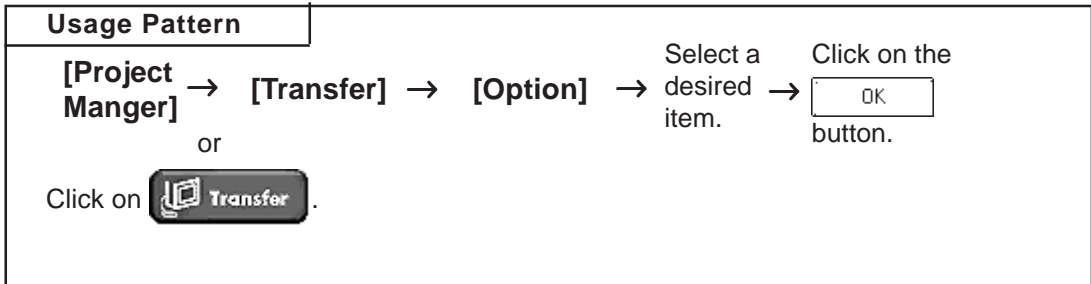

7.3.1 GP Internal Screen Data Information

GP internal information will be displayed, here. Functions such as [Screen List], [Memory Info], [GP Version], and [Upload Stored Data of CF card] are included.

■ List Screens

The screen name, data volume and title of the screens stored in the GP unit are listed by screen type.

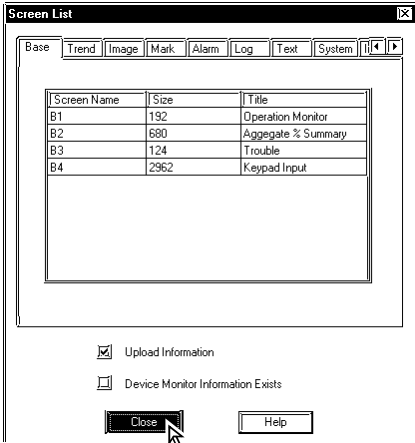
PROCEDURE	REMARKS
<p>(1) Select the [Options] menu - [Screens List] command. Screens of the current project will be listed.</p> <p>(2) After confirming the displayed information, click on the <input type="button" value="OK"/> button to close the screen list.</p> <p>[Upload Information]: .. Indicates if the upload information has been transferred to the GP unit or not.</p> <p>[Device Monitor Information Exists]: Indicates if the device monitor function has been registered or not.</p> <div style="text-align: center;">  </div>	

■ Memory Information

The GP unit's current memory capacity for each bank is displayed. Its maximum internal memory capacity is also displayed.

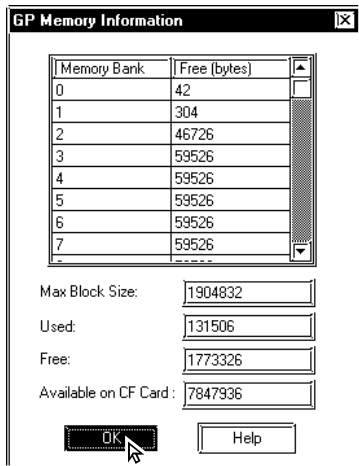
PROCEDURE	REMARKS
<p>(1) Select the [Options] menu - [Memory Info] command. The receiving of memory information begins.</p> <p>(2) After confirming the displayed information, click on the <input type="button" value="OK"/> button to close the memory information window.</p> <p>[Max Available]Displays the GP unit's allowable memory capacity.</p> <p>[Used]Displays the data volume currently used in the GP unit.</p> <p>[Free]Displays the amount of "free", or remaining memory.</p> <p>[Available on CF Card] ... Shows the remaining capacity of the CF card.</p> 	<p>Number of banks provided in each GP model:</p> <ul style="list-style-type: none"> GP-H70: 16 banks GP-270: 4 banks GP-370: 16 banks GP-470: 16 banks GP-570: 16 banks GP-571: 48 banks GP-675: 32 banks GP-870: 16 banks GP-377: 16 banks GP77R: 32 banks GP-2301H: 16 banks GP-2401H: 32 banks GP-2300: 32 banks GP-2301: 16 banks GP-2400: 64 banks GP-2500: 64 banks GP-2501: 32 banks GP-2600: 64 banks <p>(The capacity for each bank is 59526 bytes.)</p> <p>A single screen file cannot be stored in several banks. Therefore, the sum of the remaining memory capacity for each bank is not always equal to the transferrable screen data volume.</p>
<p>■ GP Version</p> <p>The GP unit's version is displayed.</p>	

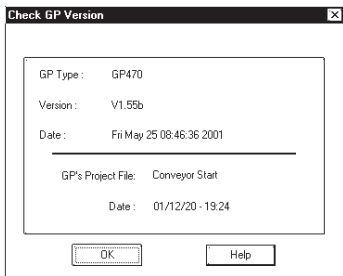
PROCEDURE	REMARKS
<p>(1) Select the [Options] menu - [GP Version] command. The receiving of the version information begins.</p> <p>(2) After confirming the displayed information, click on the <input type="button" value="OK"/> button to quit.</p> 	

■ Receiving CF Card Data

Data (*.CSV) stored on a GP's CF Card such as alarms, trend graphs, sampled data, and logged data, can be read into your PC by GP-PRO/PBIII for Windows and then used in Microsoft Excel.

Reference *Tag Reference Manual, 4.4 Using the CF Card*



This feature is supported only by the GP77R and GP2000 series. With GP77R series units, this feature requires the optional Multi Unit (sold separately).

PROCEDURE	REMARKS
<p>(1)Select the [Options] menu - [Upload Stored Data of CF Card] command. The files stored on the GP unit's CF card will be listed.</p>	
<p>(2)Select data to be uploaded to your PC and click on the button.</p>	

7.4 Setting Up Your GP via an Ethernet Network

The 2-Way driver program is pre-installed in the GP2000 (except GP-2501), which allows you to both set up your GP and transfer GP Screens. GP2000 series units also allow you set up a completely new GP from the GP's Initial Start Mode screen.



Important

Setup via the Initial Start Mode screen is available only with the GP2000 series (except the GP-2501 series).



Note:

- An optional Ethernet Interface (sold separately) is required to connect the GP-2501 series to an Ethernet network.
- The GP2000H and GP-2301 series cannot be connected to an Ethernet network.

■ System Design

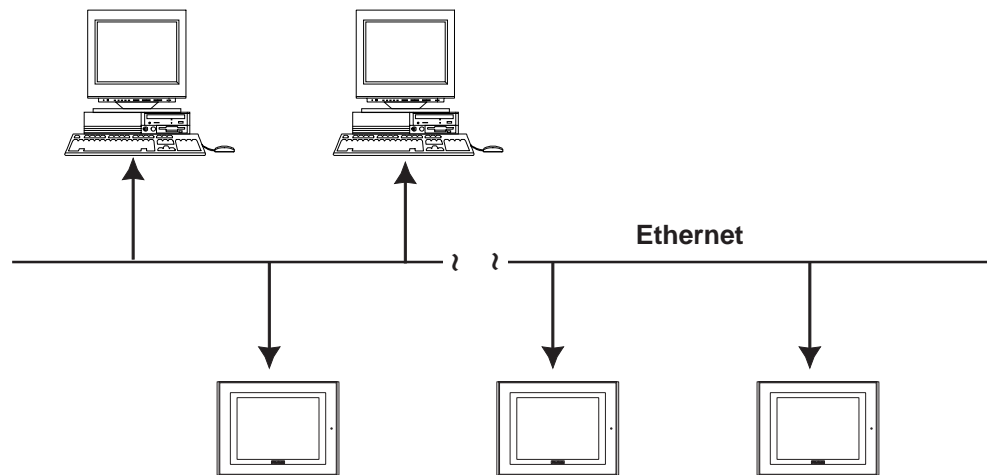

Important

- **Be sure to enter your GP's Ethernet setting information (IP address, Port number) prior to using the Ethernet network.**
- **When the default IP address is used, it is not necessary to set up an IP address. **Reference** 7.4.1 Data Transfer Using the Factory-set IP Address (The GP-2501 series cannot transmit with the default IP address.)**
- **If both GP2000 series units and GP70/77R units are used together on the same Ethernet network, even though GP2000 Series units can be set up via this network, GP70/77R Series units (with the Memory Link communication protocol or the 2-Way Driver installed) can only receive GP-PRO/PBIII project screen data.**



Note:

The GP-2000 series allows screen transfers via Ethernet regardless of the Device/PLC type. (Depending on the type of Device/PLC used, screen transfers via Ethernet may not be available with the GP-2501.) However, if the GP is not set up for Ethernet network data transfer, this feature cannot be used. If an Ethernet network cannot be used, connect the separately sold GP transfer cable (GPW-CB02) to transfer your data.

■ **Factory Settings**

The following “Initial Start Mode” screens will appear when you first connect the GP’s power cord. (The following screen is displayed only on the GP2000 series. A stock GP-2501 does not allow Ethernet settings to be designated. GP-2301H, GP-2401H and GP-2301 series can not be connected to the Ethernet.)

Display for English mode users

Touch here to call up the ETHERNET SETUP screen

If you touch the “Ethernet Setup” button, the following screen will appear. You can use this screen to enter your Ethernet settings (IP address, Port number, etc.)

Touch here to enter your settings and return to the Initial Start Mode screen

Note: If you do not wish to use an Ethernet network for data transfer, you do not need to set up the Ethernet information settings. You can set up your new GP from GP-PRO/PBIII via the GP’s separately sold data transfer cable (GPW-CB02).



Important When you first set up your GP, you need to use the GP-PRO/PBIII Transfer area transfer setting screen’s “Automatic Setup” feature. However, if you select “Do NOT perform Setup”, the GP’s system data will not be sent from GP-PRO/PBIII and the GP’s Initial Start Mode screen will appear again.

Reference For details about Ethernet settings, refer to your GP2000 Series unit’s User Manual.

■ Transfer Settings

After you have completed entering your GP’s Ethernet settings, use the GP-PRO/PBIII “Transfer” area settings dialog box to designate the data transmission method.

PROCEDURE	REMARKS
-----------	---------

(1) Select [Transfer] from the Project Manager’s [Project] window, or click on . (You can also select [Transfer] from the Drawing Board screen’s [Screen] menu or click on .) The [Transfer] screen will appear.

(2) Select [Setup] menu’s [Setup] from the [Transfer] screen, or click on , and the following [Transfer Settings] screen will appear. Designate all necessary settings.

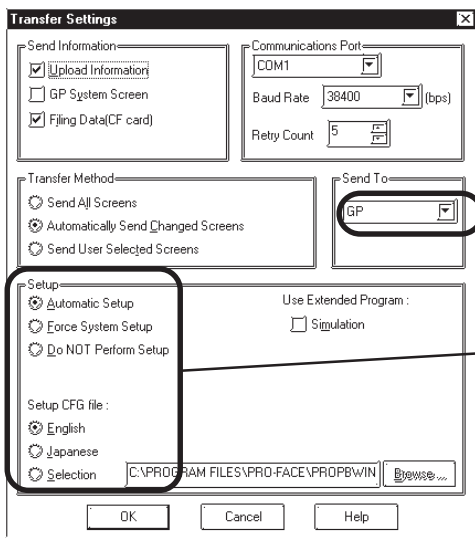

Select “Ethernet”





Select a setup type and CFG file

For details on the "Setup" type:

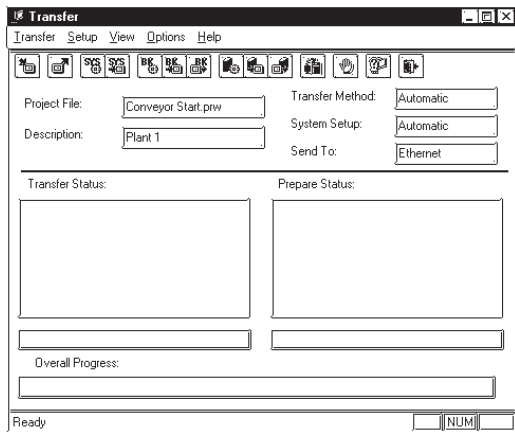
▼ **Reference** ▲ 7.2.1 Transfer Settings ◆ Set up

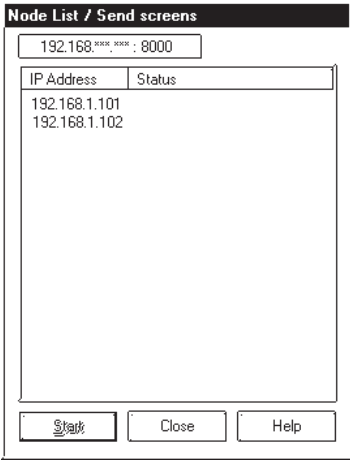
(3) Next, select [Send] from the [Transfer] menu, or click on  to start data transfer.

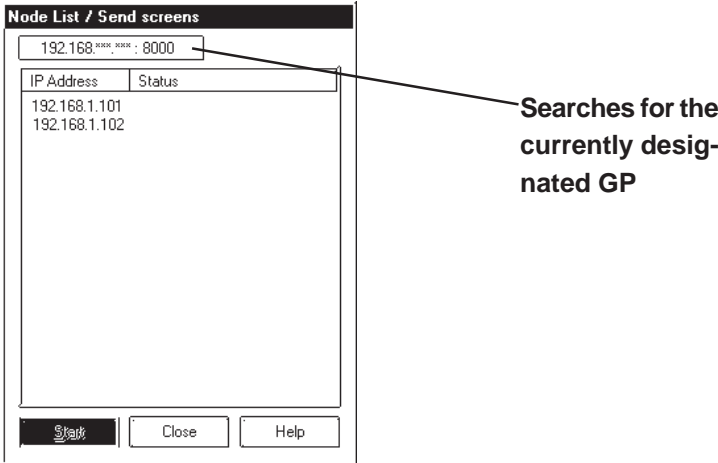

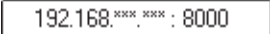
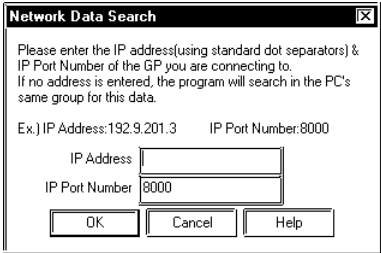
PROCEDURE	REMARKS
<p>Next, the [Node List/Send screens] dialog box will appear. Here you can see the IP addresses of all GPs connected to the network.</p>  <p>(4) Select the IP address of the GP you wish to transfer data to, and click on  .</p> 	<p>When receiving data, only one address can be selected.</p> <p>The [Node list/Send screens] window only lists the GPs which correspond to the subnet masks of the PCs used for data transfer.</p> <p> Important</p> <p>Click on  and the [Network Data Search] dialog box will appear. This dialog box allows you to search for a specific GP using the GP's IP address. The result will be displayed on the [Node List/Send screens] dialog box. If you do not change the current search condition, this feature will automatically search using the current data. Therefore, be sure when using this feature that the current search condition is the one that is actually desired.</p> 

7.4.1 Data Transfer Using the Factory-set IP Address

The default IP address of the GP is set at the factory for high-speed transfers of setups and screens via Ethernet.



- ***This function is available only with GP2000 (except GP-2301H, GP-2401H, GP-2301, GP-2501) series units.***

The IP address of the GP unit is factory-configured. The IP address is used when the IP address/Subnet Mask setup on the GP is "0.0.0.0".

Requirements for the use of the factory-set IP address

IP address / subnet mask	IP Settings Used
If set to 0.0.0.0	Factory set IP address
anyother IP address	IP address set up arbitrarily



- ***Be sure to set the TCP/IP data (IP address should be set from 10.255.255.1 to 10.255.255.254) and the subnet mask (255.0.0.0) of a PC that is running GP-PRO/PB III for Windows, and where Ethernet screen transfer will be performed. Also, some PCs must be rebooted for the TCP/IP setting to be activated.***
- ***When the GP unit's IP address and subnet mask are set (an S200 file is generated), the TCP/IP data (IP address and subnet mask) used by the PC should be the same.***
- ***Do not use the factory-set IP address when a private address (10.***.***.***) is used on the same network. Otherwise, a network communication error may occur.***

Click on the "Send" icon and GP-PRO/PBIII will search for the IP addresses of the GP units connected to the network. If a GP unit is connected to the Ethernet network and the user has not yet entered IP address settings for that unit, that unit's factory-set IP address will be used, and that address will appear in the "Node List" shown below. Next, use the standard steps to transfer data to the desired GP unit.

The following "Node List" shows the result of a search. In this case, the GP unit found has no user-designated IP address settings and the factory-set IP address is listed.

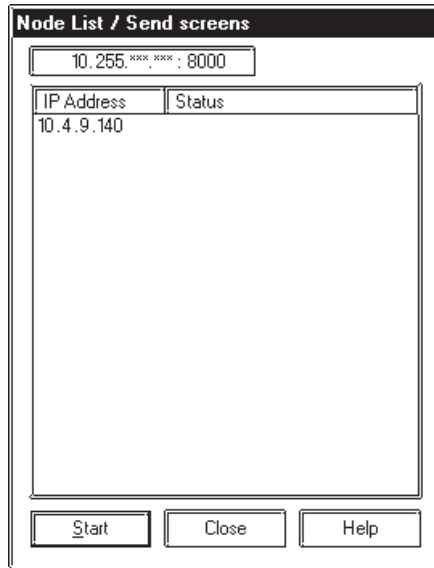

Before transferring screen data to the GP unit and connecting the GP unit to the host PLC, you can check the GP panel operation by running a simulation of your GP-PRO/PB III for Windows program.

This chapter describes the program simulation procedure.

8.1 Overview

8.1 Overview

Connect the GP unit to your personal computer via the transfer cable. Turn ON/OFF bits on the GP-PRO/PB III program's Simulation screen, and change the data corresponding to the specified word address. This enables you to check the operation in the GP unit and the data changes resulting from the Tag and Part functions. In addition, the Snapshot function allows GP screens to be saved in JPEG format to the GP/GLC unit's CF Card .

▼ **Reference** ▲ 8.1.5 Snapshot Function



Important

The Simulation feature is provided for simulating PLC operations on a PC. Since this is only a simulation, its performance may differ from the actual PLC.



Note:

Connecting method is the same as the one for data transfer.

▼ **Reference** ▲ 7.1 Prior to Transferring Data

The Simulation function can be used through the GP screen transfer cable or through Ethernet. (▼ **Reference** ▲ 8.1.4 Simulation (Ethernet))

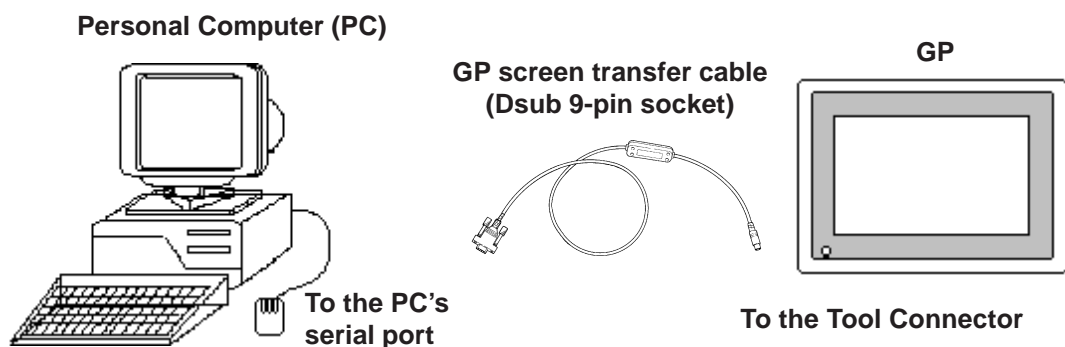

■ Precautions

When using the Simulation function keep in mind the following restrictions:

- To carry out a simulation, you need to transfer screen data and a simulation protocol, and create simulation data in advance.
- The Simulation function is only intended for a “1:1” connection between the GP unit and your personal computer. When your personal computer is connected to more than one GP unit (“n:1”, multi-link), the simulation cannot be performed.
- When the Device/PLC type is specified as “Memory Link SIO Type” or “Memory Link Ethernet Type”, or “CC-Link Type”, the simulation cannot be performed.

- When the display address for the E-Tag or K-Tag is indirectly specified (“Indirect” is selected for the [Data Format] tab) and “Area subsequent to the display address” is specified as the indirectly-specified area, the simulation cannot be performed.
- With a device specified in [GP System Setting] (n:1 communication information, watchdog, video control area, alarm count, HITACHI HIDIC S I/O extended memory device, etc.), the simulation cannot be performed.
- No simulation can be carried out for any address larger than 32768 (8000h). To perform a simulation for such an address, temporarily change the address to 32767 or smaller.
- The GP unit’s device monitor feature cannot be used.
- Do not press any touch panel switch on the GP unit before the simulation has begun; and, do not change the screen on the GP panel. Otherwise, a system error will occur.
- The LS device simulation is only effective for the GP-377 series, GP77R series and GP2000 series.
- If the backup function for the LS area is selected, or if a D-Script, W-tag, etc. uses an LS area special relay for its start bit, no LS device can be simulated.
- If the LS device is frequently written using the D-script during the LS device simulation, actions such as a slide transition will be slow.
- When performing simulation on the GP-377 series, GP77R series or GP2000 series, DO NOT specify [GP System Settings] - [Extended Settings] tab - [Reset GP On Data Write Error].
- When using Yamatake's SDC Series Device/PLC, deselect [GP Settings] - [Extended Settings] tab - [System Area Settings].
- When using the GP77R series or GP2000 series and Mitsubishi Electric's CPU direct connection type Device/PLC (such as Mitsubishi MELSEC-AnA (CPU)), with the GP offline mode's [Setup Operating Environment] - [Built-in] selected, the simulation function cannot be used. Select [Adapter] or [Direct] and then perform simulation.
- The Simulation function is disabled when the Device/PLC type is set to "THERMAC NEO series (OMRON)".

8.1.1 General Description of the Simulation Screen

To perform a simulation, first transfer the screen data created with the GP-PRO/PB III program and the “simulation protocol” to the GP unit.

Reference 7.2 Transferring Screens



Note: • Designate the System Area settings before using the Simulation function. Click **GP Setup** and select the [Extended Settings] tab. Click on the right side “System Area...” button and specify the "Current Screen No." and "Chg.scr. (Change To Screen No.)" fields.

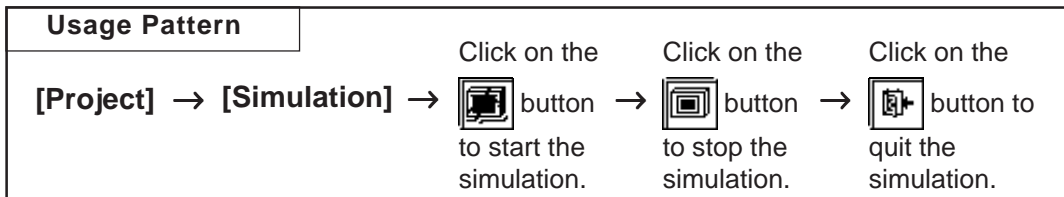

General description of the Simulation screen:

Enter the Base Screen number where device information is to be displayed

Select a function to display device information.

Displays negative values with a minus sign

Selects the format of the display and input data

Select which to screen to be displayed on the GP panel during the simulation

Starts/Stops the simulation

Blinks while the simulation is being executed

Displays the device information of Tags and Parts placed on each screen

Changes the device status

Changes the system status

Displays the current status of the system

Name/Description	Function	Address	Status	Alter	No.	System Area
N_0000	Data Storage Address	D00000	1		+00	1
K_0000	Trigger Bit Address	X00000	OFF		+01	0
K_0000	Data Storage Addr	D00001	0		+02	1
K_0001	Trigger Bit Address	X00000	OFF		+03	16
K_0001	Data Storage Addr	D00002	1		+04	41
K_0002	Trigger Bit Address	X00000	OFF		+05	4930
K_0002	Data Storage Addr	D00003	16		+06	0
T_0000	Op. Bit Addr.	X00010	OFF		+07	0
T_0001	Op. Bit Addr.	X00011	OFF		+08	0
G_0000	Data Storage Address	D00000	1		+09	0
					+10	0
					+11	0
					+12	0
					+13	0
					+14	0
					+15	0
					+16	0
					+17	0
					+18	0

◆ **Chg. Scr.**

When the check box is marked, the GP panel screen is changed according to the Simulation screen. When this check box is , the GP's screen can be separately changed, independent of the Simulation screen.

◆ **Displayed Function Selection**

The function used to display the simulation can be changed. In addition to the settings of each screen, the devices show in the following figure that have been set with the screen-independent global functions can also be displayed.



◆ **Format**

The data format of the device status (displayed in the “Status” cell) and the device data (displayed in the “Change” cell) can be selected for “Dec” (decimal), “Hex” (hexadecimal), or “Oct” (octadecimal) format.

◆ **+/-**

Marking the “+/-” check box adds a “- (minus)” sign to the displayed values, if the word address settings displayed in the “Status” cell are negative values.

◆ **Tag Name/Comment**

The Tag name (or ID number of a Part) or any comment is displayed. To switch the Tag name or comment display mode, select [Tag Name] or [Comment] from the [View] menu.

◆ **Function**

A general description of the device function for each specified Tag or Part is displayed.

◆ **Address**

The device specified for each Tag or Part is displayed and you can change their word address settings.

◆ **Status**

The current status of each device (bit ON/OFF status or word address setting) is displayed, and you can change their word address settings.

◆ **Alter**

You can change each device status (bit ON/OFF) or the word address settings.

Every time you click on the  icon, the bit ON/OFF status is switched.

When you click on the  icon, the following Keypad will appear, enabling you to change the data.

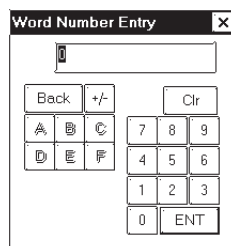

◆ No.

You can change the status (settings) of the system data when you click on the  icon. A Keypad will appear, enabling you to enter desired number changes.

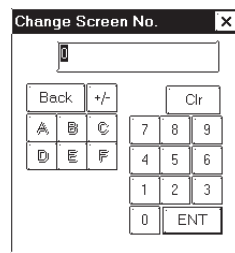

◆ Area

The current status (settings) of the GP unit' system data area is displayed, and you can change these settings by directly entering new data.

■ Selecting a Display Type

Select the types of Tags and Parts used to display device information. Select the [Options] menu - [Display Type Settings] command.

Specify the Tags and Parts to be displayed.

When you select "All Type", information on all Tags and Parts will be displayed.

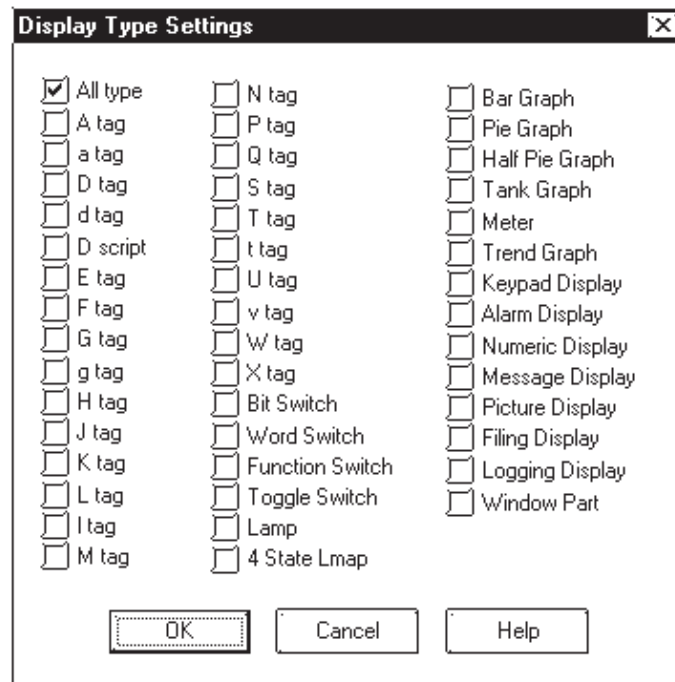

■ Setting up the Device Memory

Even after the simulation function has been closed, device information can be saved to the Project File.

Select the [Options] menu - [Device Memory Settings] command.

When the “Backup” check box is marked , device information is automatically saved when the simulation function is quit. When the simulation starts up again, the same device status will be displayed.

Clicking on the button resets all device settings to “0”.

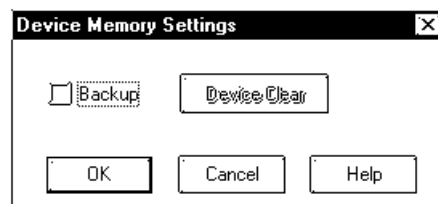

■ Movement Settings

If your GP unit type is a GP-377, GP-7R or GP2000 series unit, LS devices can also be simulated in the range from LS0020 to LS2031 (excluding the read-in area) and LS2096 to LS4095 (LS2096 to LS8191 for GP-2000 series unit). Select the [Movement Settings] command from the [Option] menu.

If the [LS Device] check box is marked, the tags and parts that use LS devices will be displayed when a simulation is executed.

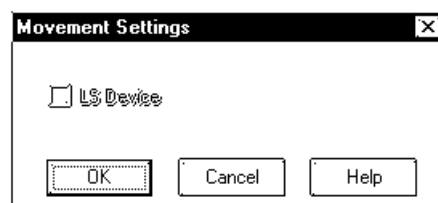

To use the Snapshot function, enable "LS Device Simulation" by checking the check box.

Reference 8.1.5 Snapshot Function

■ Address Registration

Simulation can be performed for any registered address, not for each screen or function.

The simulation result is displayed by selecting the registered address from the display function pull-down list's [Address Registration].

To register/edit an address, select the [Simulation] menu - [Address Registration] command.

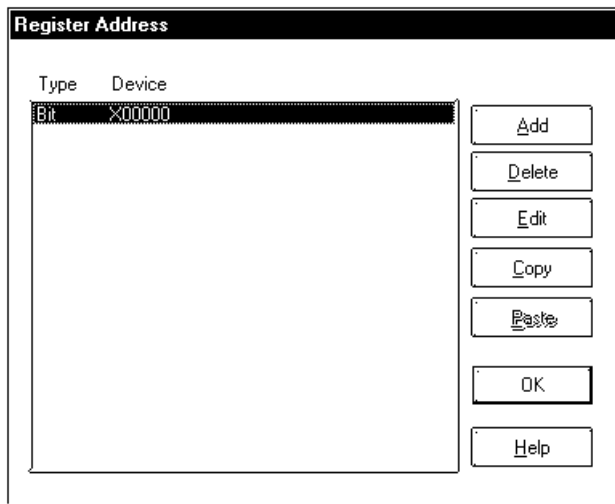

◆ Adding a registered address

You can add a new address. Click on the button, and the following dialog box will appear. Then, enter an address and the number of addresses to be added, and specify Bit or Word.

After entering a number of addresses to be added, addresses are added from the designated number in series.

You can enter a desired name as a function name with up to 20 half-sized characters.

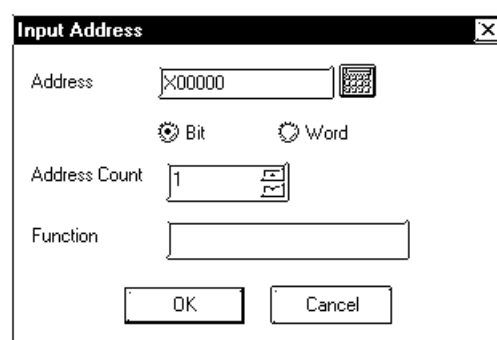

◆ Editing a registered address

You can change the registered address settings. Select an address to be edited and click on the button. Then, a dialog box that is the same as for the adding of a registered address will appear.

◆ Deleting a registered address

You can delete a registered address. Select an address to be deleted and click on the button. Then, a dialog box will appear to confirm the command. If you execute the delete command, click on the button, and if you cancel it, click on the button.

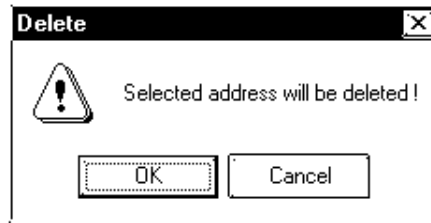
**◆ Copying and pasting a registered address**

Select an address to be copied and click on the button. Then, click on the button to add the copied address at the end of the list.

8.1.2 Transferring Simulation Protocol

To simulate the GP panel's actual operation using the GP-PRO/PB III program, transfer the screen data created with the GP-PRO/PB III program along with the "simulation protocol" to the GP unit.

Reference 7.2 Transferring Screens

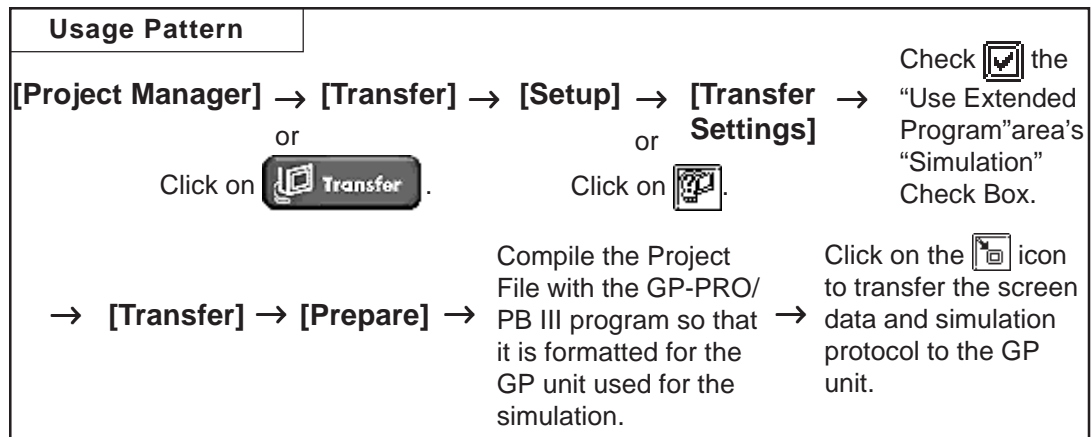

■ Simulation Protocol

Before executing the simulation, you must first transfer the simulation protocol to the GP unit, regardless of the Device/PLC type specified for the project file.

Check the "Use Extended Program" area's "Simulation" Check Box in the [Transfer Settings] dialog box so that when screens are transferred, the simulation protocol will be transferred to the GP unit.

Reference 7.2.1 Transfer Settings



Important

If you are using a GP70 Series unit, normal communications with the Device/PLC cannot be carried out with the simulation protocol. To re-establish the link with the Device/PLC after executing a simulation, be sure to send the GP Unit communication protocol for the Device/PLC type, and then re-set the GP unit.



Note:

- When a simulation is executed with the GP77R series or GP2000 series, you need to transfer the simulation protocol only for the first screen transfer.
- If you are using a GP other than GP77R or GP2000 Series unit, "Set Up Operation Surroundings" in the GP unit's PLC setup menu cannot be used while the simulation protocol is transferred.

8.1.3 Performing a Simulation







To perform a simulation, first connect the GP unit to your personal computer using the Data Transfer Cable.





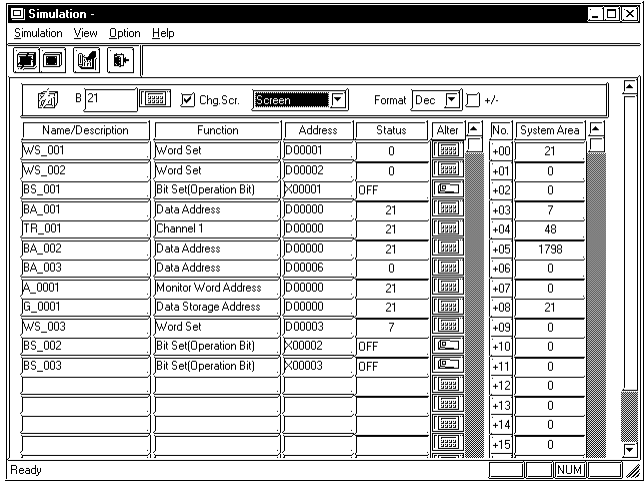

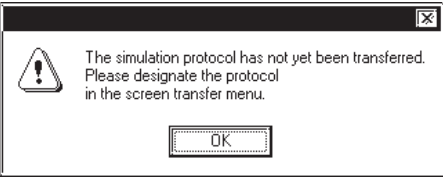
Before performing a simulation, you must transfer the simulation protocol to the GP unit.

Reference 8.1.2 Transferring Simulation Protocol

■ Performing a Simulation

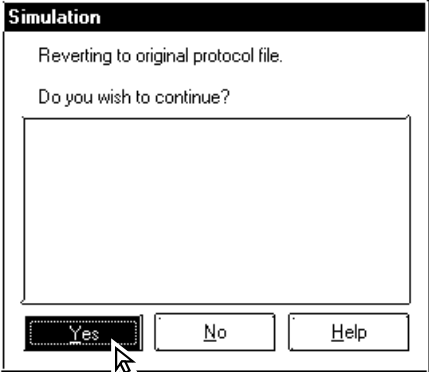
PROCEDURE	REMARKS
<p>Connect the GP unit to your personal computer with the Data Transfer Cable.</p> <p>1) Via the Project Manager, select the [Project] menu - [Simulation] command, or click on the  icon.</p> <p>2) Click on the  button to begin communication with the GP unit.</p> <p>The device information on the current GP panel screen is displayed.</p>  <p>You can check the GP panel operation by switching screens or changing the device settings using the  or  icon displayed in the [Alter] cell. Also, you can check the device status changes via the GP's touch keys.</p>	<p>Prior to starting simulation, set the GP unit to the RUN mode.</p> <p>If the simulation protocol has not been transferred to the GP unit in step (1), the following dialog box will appear, and the simulation cannot be started.</p>  <p>During communication, the  icon blinks, like this .</p> <p>Reference 8.1.1 General Description of the Simulation Screen</p>

PROCEDURE	REMARKS
<p>3) Click on the  button to quit the simulation.</p> <p>4) Click on the  button to quit the simulation mode.</p> <p>When you quit the simulation mode, the system asks if you wish to again set up the GP unit for communication with the PLC.</p> <p>If you select <input type="button" value="Yes"/> , the system will set up the GP Unit. If you select <input type="button" value="No"/> , the system returns to the Project Manager without setting up the GP Unit.</p> <div data-bbox="304 667 735 1037" style="border: 1px solid black; padding: 5px; margin: 10px 0;"> <p>Simulation</p> <p>Reverting to original protocol file.</p> <p>Do you wish to continue?</p> <div style="border: 1px solid black; height: 80px; width: 100%;"></div> <p><input type="button" value="Yes"/> <input type="button" value="No"/> <input type="button" value="Help"/></p> </div> <div style="text-align: center; margin: 10px 0;">  </div> <div data-bbox="379 1160 815 1529" style="border: 1px solid black; padding: 5px; margin: 10px 0;"> <p>Simulation</p> <p>Finished.</p> <div style="border: 1px solid black; padding: 2px;"> <p>Transferring loader program ...</p> <p>Handshaking ...</p> <p>Downloading protocol file ...</p> <p>Please do not turn off GP</p> <p>Binary transferring ...</p> <p>Binary transferring ...</p> <p>Resetting GP ...</p> <p>--- End System Setup ---</p> </div> <p style="text-align: center;"><input type="button" value="Ok"/></p> </div>	<p>During simulation, screen data cannot be transferred. Click on the  icon and stop simulation before transferring screen data.</p> <p><i>Simulation protocol cannot be used for normal communication with a PLC. To re-establish the link with the PLC after executing a simulation, be sure to send the GP Unit communication protocol for the Device/PLC type, and then re-set the GP unit.</i></p> <p><i>When using a GP77R or GP2000 series unit, you do not need to set up your GP unit again.</i></p>

8.1.4 Simulation (Ethernet)

■ Simulation via an Ethernet Network

Only GP2000 series can use this function.



- Using the function with the GP-2501 requires a large-scale Multi Unit E or a GP Ethernet Interface unit.
- The GP-2301H, GP-2401H and GP-2301 cannot be connected to an Ethernet network.

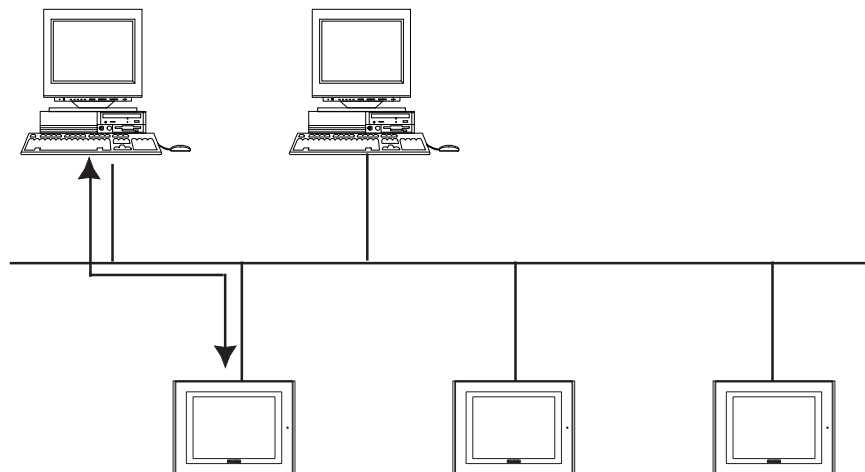

The simulation function using Ethernet provides the same level of functionality as when using the data transfer cable. The limitations for this feature are the same as for the transfer cable.



Important

- *To perform a simulation, download the screen data and the special simulation protocol to the GP via the Ethernet network.*
- *Simulations via Ethernet and the transfer cable cannot be performed simultaneously.*
- *LS device simulation can be also performed.*
- *When using the simulation function, do not transfer screens to the GP.*

■ Transfer Setting Dialog Box

Whether the simulation is performed through the serial port or through Ethernet is determined in the transfer setting dialog box in the [Transfer Screen].

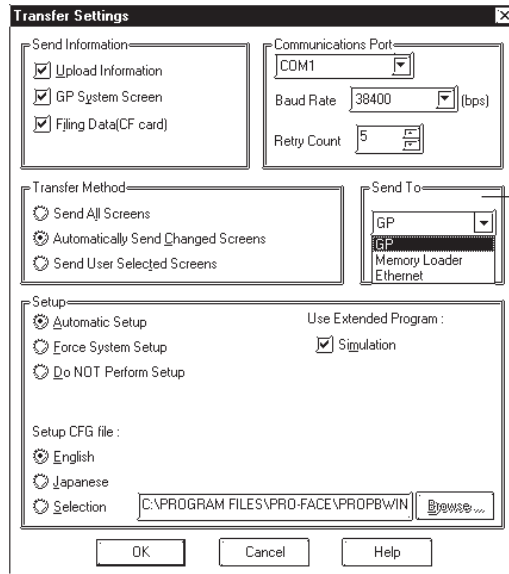

GP: Via serial port
Ethernet: Via Ethernet
When the simulation is performed via the serial port, the serial port settings are effective.

■ Selecting the GP

To begin the simulation, click on the  icon, or select the Simulation feature from the [Project] pull-down menu. When the start button is clicked, the connected GPs will be listed.



- The simulated communication via Ethernet can be performed with only one GP selected from the node list.
- Multiple GPs cannot be selected in the node list.



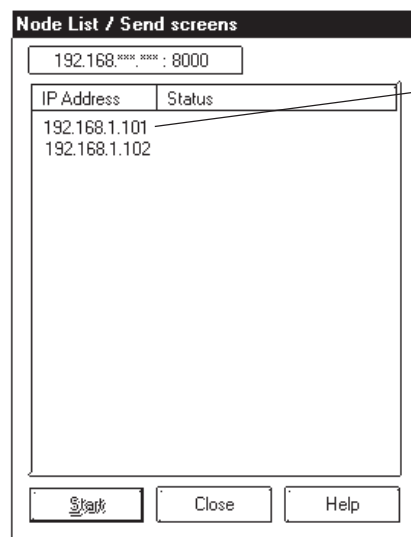

After you select a GP from the list and click the Start button, the node list dialog box will close and the simulation screen will appear.

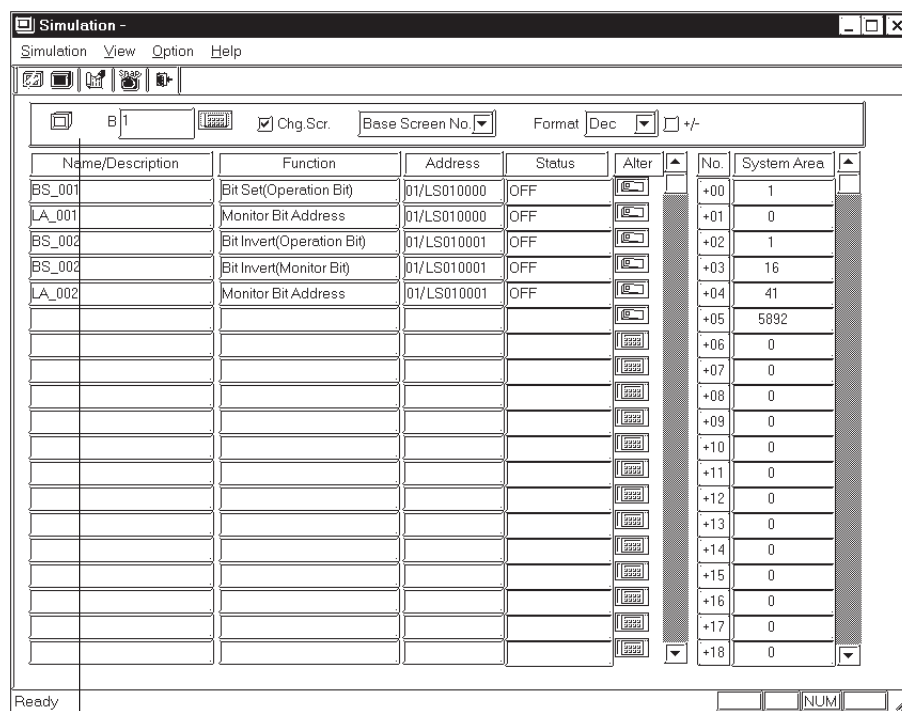

Click on the start button to begin searching for all GPs connected to the Ethernet network. All connected GPs will be appear in the node list.



- Note:**
- If you stop the simulation and then click the [Start] button again, the node list will be displayed again.
 - While the simulation is being performed, the target GP cannot be changed.
 - To use the factory-set IP address, the IP address and the subnet mask in the PC should be changed.

8.1.5 Snapshot Function

This feature allows Simulation screens of the GP to be written onto a CF Card in JPEG file format with the ease of taking a snapshot.



- **A CF Card is required to use the Snapshot function.**
- **This function is available only with the GP2000 series.**

■ Performing a Snapshot Function

PROCEDURE	REMARKS
<p>(1) Perform a simulation.</p> <p>(2) When the screen to be simulated is displayed on the GP screen, select [Snapshot] from the [Simulation] menu on the "Simulation" screen or click  on your PC screen (GP-PRO/PB III). The JPEG file captured with the snapshot function is automatically stored on the CF Card attached to the GP unit. The complete operation takes five or six seconds.</p>	<p>Reference 8.1.3 <i>Performing a Simulation</i></p> <p>Enable "LS Device Simulation" in the Movement Settings.</p> <p>Reference 8.1.1 <i>General Description of the Simulation Screen</i> ■ <i>Movement Settings</i></p>

■ JPEG File Name

JPEG files are automatically assigned a file name according to a numerical sequence. The file name of a saved JPEG file will be "\CAPTURE\CPXXXXX.JPG" (XXXXXX is a number from 0 to 65535, assigned sequentially). The number is automatically incremented by one (XXXXX) from the largest file number existing on the CF Card. The Snapshot function is disabled when the number sequence exceeds "65535" or the free space on the CF Card is insufficient.

■ Reverse Black & White

When the "Reverse Black & White" feature is enabled under the Screen Capture function (**Reference** *Tag Reference Manual, 4.4.9 Screen Capture*), black and white are reversed in the snapshot image of the simulation. **Reference** *Tag Reference Manual, 4.4.9* ◆ *Reverse Black & White*

■ Snapshot Errors

The following error messages are displayed on your PC when CF Card errors occur during the Snapshot operation. If a warning is displayed, no JPEG file is created on the CF Card.

Error Message	Error Conditions
No CF Card is inserted in the GP.	-No CF Card is inserted. -The CF Card cover is not completely closed.
The snapshot cannot be written to the CF Card inserted in the GP.	-Insufficient free space remains on the CF Card. -The CF Card was removed while data was being saved.
Invalid CF Card is inserted in the GP.	-An operation failure has been detected with the CF Card, or the CF Card is unformatted.

Memo

A printed copy of created screens and Tag designation status is often useful when debugging. This chapter describes the printing procedure and print settings.

9.1	Print Settings
9.2	Sample Printer Output

9.1 Print Settings

This section describes the procedure for printing created screens or a list of specified Tags, and options available when printing.

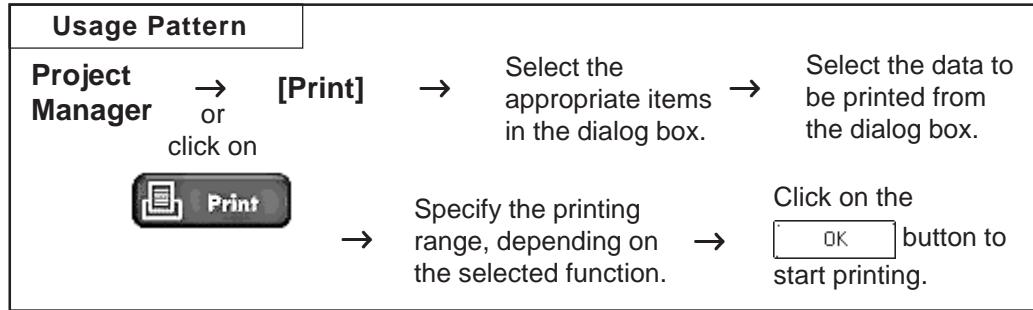

9.1.1 Printing

When you select the [Project] menu - [Print] command, the [Print] screen will be displayed.

■ Printing - [Print] Tab

Specify the printer type and other print settings on your personal computer. Only Windows-compatible printers that can be connected to your personal computer can be used to print with GP-PRO/PBIII for Windows.

Displays the printer name specified on your personal computer

Click on this button to display the Cover Page dialog box

Comments on the data printed can be entered to be printed out along with the data. To print comments, check this box; to display the Comment Information dialog box, click on the "Detail" button

Click on this button to display the [Options] dialog box

Displays the printing-related [Property] dialog box

A cover page with a title, company name, date/time, name, and a bit map can be included with the document. To print a cover page, check this box

If this box is checked, instead of printing a hard-copy, the data is saved as a RTF text file (.RTF), and can be edited with other text editing software**

Enter the number of copies to be printed; the default setting is 1

Select the Text Table to be printed.

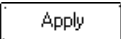

- The printing setting information can be saved by clicking on the  button.
- The printing orientation is "Vertical" (Portrait).
- Only "A3", "B4", or "A4" paper can be used for printing.

◆ Cover Page Dialog Box

Check this box to print a title on the cover page

Enter a title or a company name of up to 3 lines (40 characters per line)

Check this box to include the date and time of printing on the cover page

Check this box to include a Bit-map on the cover page

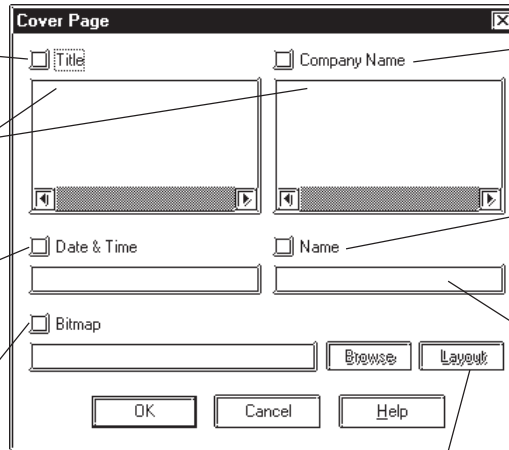

Check this box to print a company name on the cover page

Check this box to print a name on the cover page

Enter the name here

Click on this button to preview the cover page layout. When Bit-map printing is selected, the placement of the Bit-map on the cover page can be changed.

◆ Comment Information Dialog Box

Enter a comment of up to 40 lines (80 characters per line)

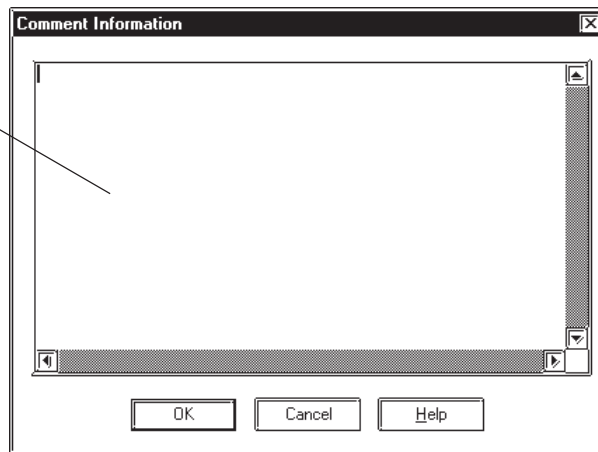

◆ Options Dialog Box

Settings in the Options dialog box allow you to format the pages of the document to be printed. You can specify the range of page numbers to be printed, the screen color, and margin size.

Prints the black/white-reversed screen color

Check this box to print the page number on each page of the document

When printing page numbers, specify if the cover page is to be numbered

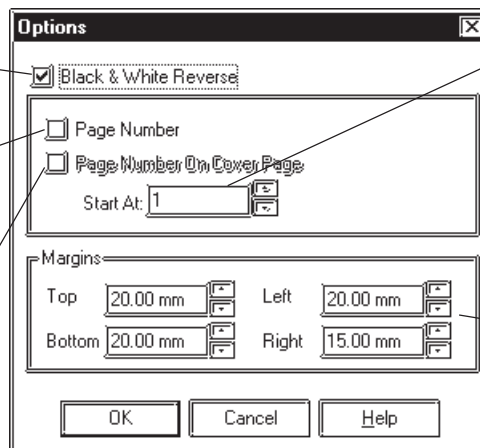

Enter the initial page number to be printed on the first page of the document

Specify the upper, lower, right and left margin sizes

■ Printing - [Project Information] Tab

You can check the created screens and Tag designation status through printer output.

Prints a project information summary list

Prints the list of settings of the item marked with a check.

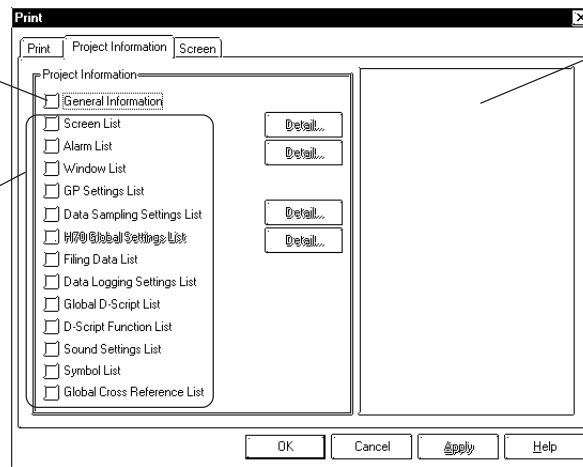

Displays the currently-selected item

◆ Details

Click on the button to specify detailed information of printing.

Screen List

Select the screen type to be printed.

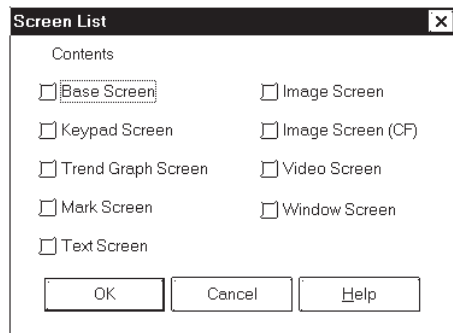

Alarm List

Select the alarm type to be printed.

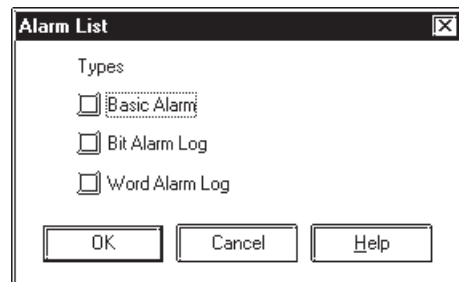

Date Sampling Settings List

Select whether to print the summary or details of the data sampling settings.

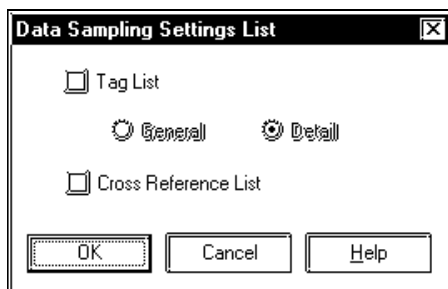

Handy Global Setting List

Select whether to print the summary or details of the Handy global settings.

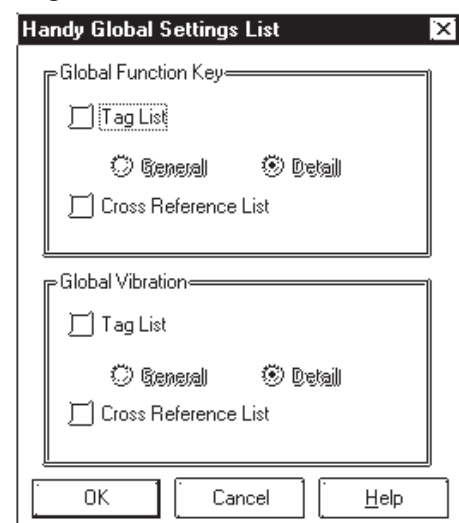

■ **Printing - [Screen] Tab**

Select the screen type and contents to be printed.

Select the screen type to be printed

Specify the printing range by screen numbers. When you select [All (A)], all screens will be printed.

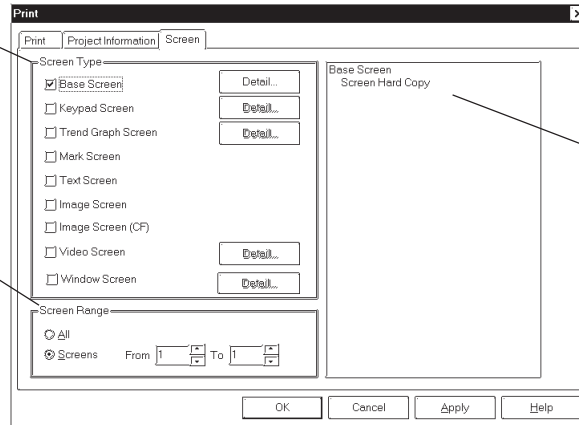

Displays the currently-selected item

◆ **Details**

Click on the button to specify detailed information of printing.

Base Screen

Specify the printing items related to a Base Screen.

Prints a list of the screens loaded onto a specified screen

Prints a list of the specified Tags. Select whether to print the summary or details of the Tag list

Prints a list of the Parts placed on the Base Screen. Select whether to print the summary or details of the Part list

Prints the D-Script settings

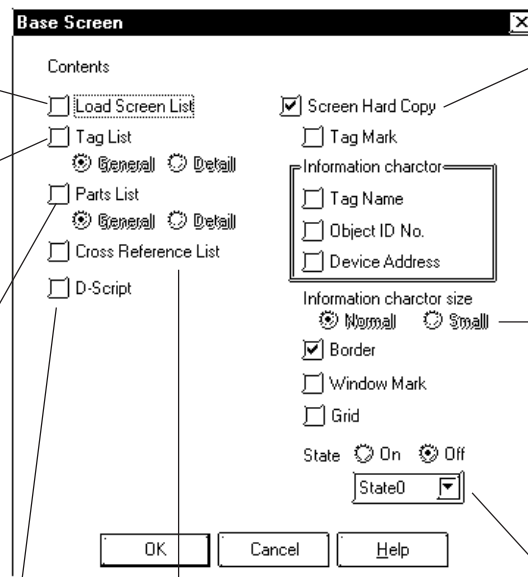

Outputs screen hard copies. The printing items can be specified

Select Information character's printing size. When selecting [Small], 1/4-sized characters are used

Prints the address designation for Tags. Only the "preset addresses" can be printed

Reference 2.8.7 Cross Reference List

When making a screen hard copy, The Parts' ON/OFF status can be specified. The same status is specified for all screens to be printed



Note: When the summary of the Part list is printed, its right edge may get outside the paper. In this case, open the Option dialog box by clicking on button in the [Print] tab, and then reduce the left margin.

Keypad Screen

Specify the printing items related to a Keypad screen.

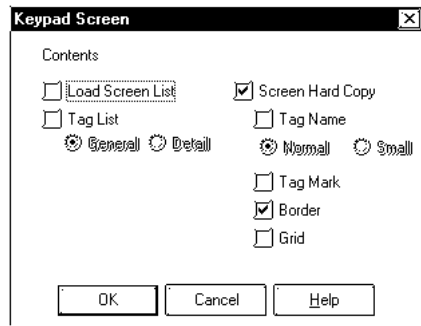

Trend Graph Screen

Specify the printing items related to a Trend Graph screen.

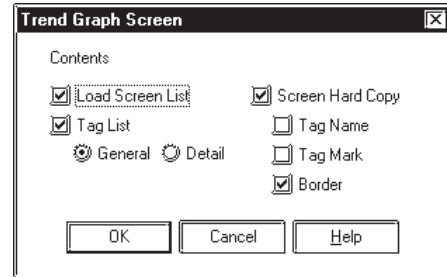

Video Screen

Specify the printing items related to a Video screen.

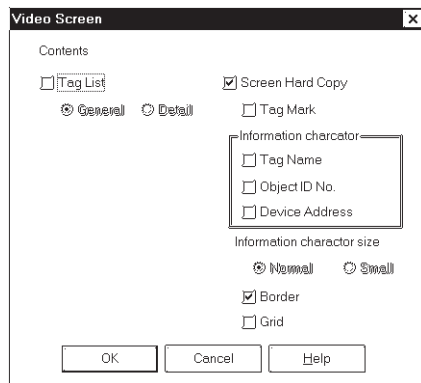

Window Screen

Specify the printing items related to a Window screen.

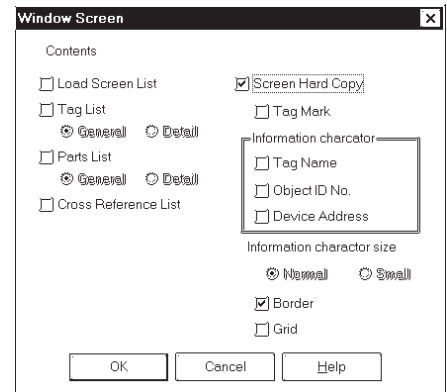

9.1.2 Print Preview

By selecting the [Project] menu - [Print Preview], you can preview the screen image to be printed.

Setting items are the same as those of printing. Instead of clicking on the

button, click on the button.

■ Print Preview Screen

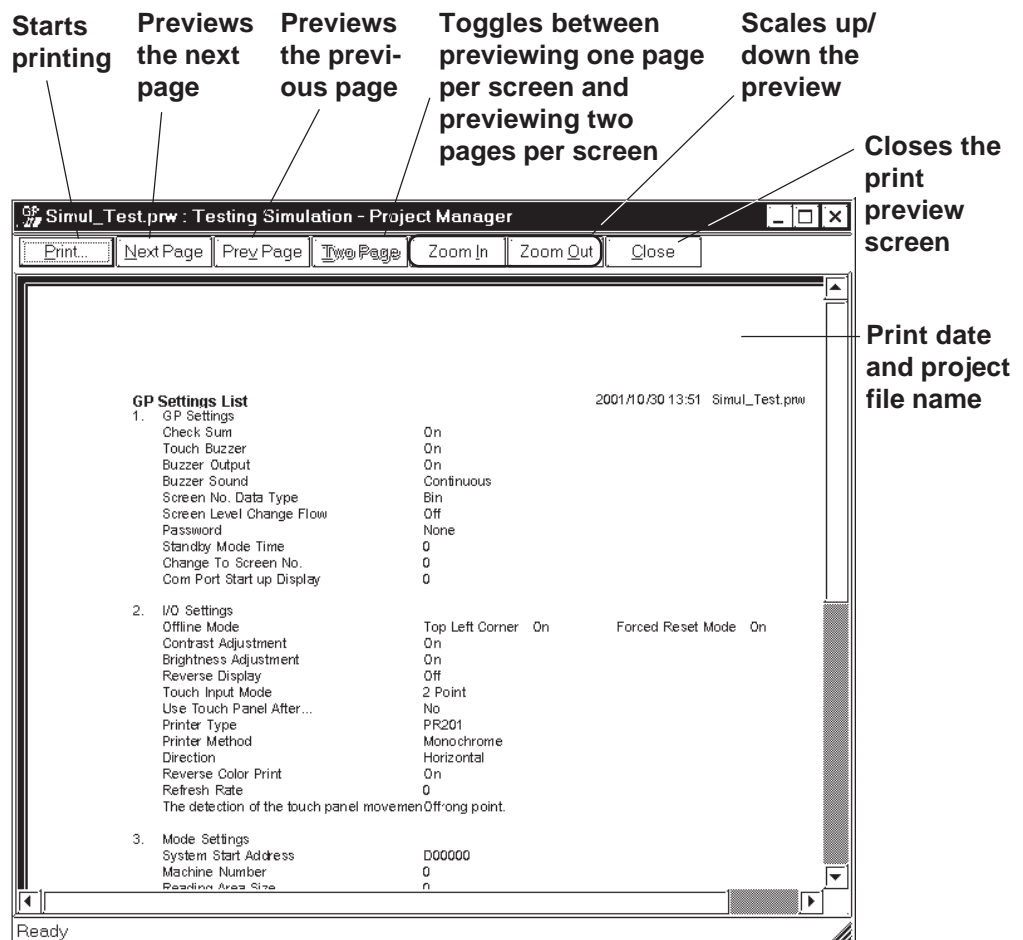

9.2 Sample Printer Output

This section provides sample printing of various data such as a created screen or a list of specified Tags.
The following data can be printed.

■ Printing

◆ Cover Page

Select whether the cover page is to be printed or not.

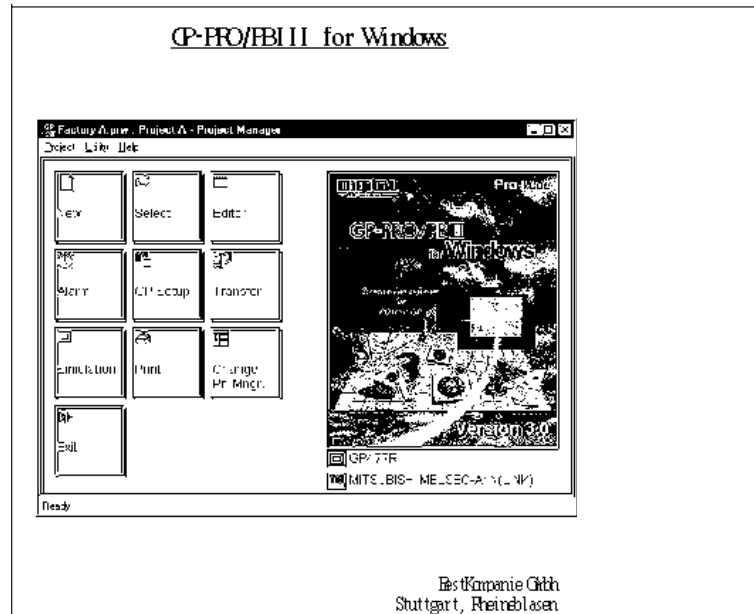

◆ Comment Information

Select whether comment information is to be printed or not. Comment information is a function to add supplemental information to the printed data. Up to 40 lines of 80 characters can be entered.

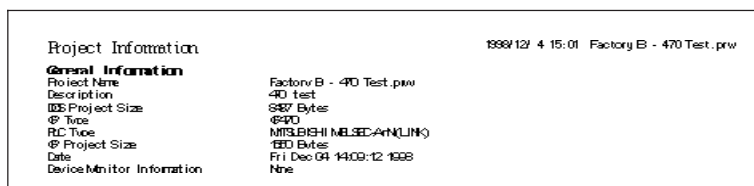

■ Project Information

◆ Summary

Prints a project summary list.

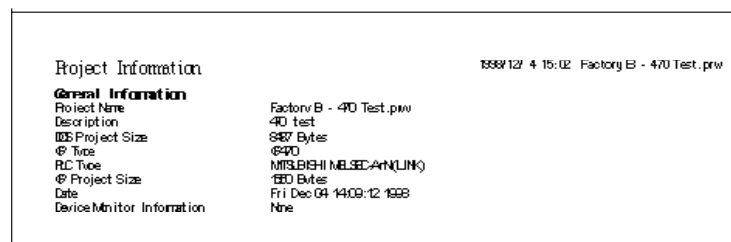

◆ **Screen List**

Prints a list of the screens of a specified type.

Screen List			1997/12/ 4 15:08 Factory B - 4FD Test.pnw
1 Base Screen	Screen	Description	Date/Time
B1	First Screen		12/4/98 15:07
B1	Operation Monitor		12/4/98 15:05
B2	Alarm Summary		12/4/98 15:05
B3	Trouble		12/4/98 15:05
B4	Leveled Inout		12/4/98 15:05
B1	State Switch		12/4/98 15:05

◆ **Alarm List**

Prints a list of the created alarms.

Alarm List					1997/12/ 4 15:26 Factory B - 4FD Test.pnw
Bit Alarm/Loa (Block1)					
No.	Bit Address	Group	Sub Display	State	
1	000100	0	0	On	
	Ramp 3 ON				
2	000101	0	0	On	
	Ramp 2 ON				
3	000102	0	0	On	
	Ramp 1 ON				

◆ **Registered Window List**

Prints the window registration status.

Window List				
Window	Screen	Position	Size	Title
1	B1	(176, 67)(1423, 264)	248x198	Location Window
2	B1	(56, 193)(135, 286)	80x94	Bit Switch Window

◆ **GP System Setting List**

Prints the GP system settings.

GP Settings List			1997/12/ 4 15:34 Factory B - 4FD Test.pnw
1.	System Settings		
	Deck Sim	On	
	Screen Change Flarehart	Off	
	Touch Buzzer	On	
	Buzzer Output	On	
	Buzzer Sound	Continual	
	Screen No. Data Type	Bin	
	Password	Nine	
	Display Standby Time	0	
	Change Screen	0	
	OnPort Starting Up	0	
2.	I/O Settings		
	Offline Mode	Top Left Corner	On SystemReset Mode On

◆ **Data Sampling Setting List**

Prints the data sampling settings.

Data Sampling Settings List	
Detail of Tags Setting	
Setup Channel	
Name	00001
Description	Data Sampling
Simolina Address	0000
Tripper Bit Address	X000
TopWrite Address	18000
No. of Sampling Addr.	1
Data Backup	No
Synchronous Mode	- - -
Simolina Time	Period. No
Simolina Time	60
Sampling Monitor Address	- - -

◆ Handy Global Setting List
(Function Keys)/(Vibration)

```

Global Function Settings List
-----
Tag List
T_Tag
Name Fn Key_Description Mode Op. Bit Addr. Op. Word Addr. Calc. Data Addr.
_0000 F1 Bit Set X00000 - - - - -

t_Tag
Name Fn Key_Description Op. Bit Addr.1 Op. Bit Addr.2
_0000 F9 X00000 X00000

k_Tag
Name Fn Key_Description Mode Character Screen Number
_0000 F14 Convert Text Input - - - - -

Global Vibration
Name ---
Comment test2
Mode Bit
Address X00001
Trigger 0->1
Alarm - - -
Alarm - - -
Vibration time 10
Buzzer OFF

Cross Reference List
Bit Address Tag Name Parts ID
X00000 Global Vibration
X00001 Global Vibration
    
```

Prints the Handy global settings.

◆ Filing Data Setting List

```

Filing Settings
Filing (ON/OFF) On
Control Word Address D000
Write Completed Bit Address X0000
ELC Controlled Transfer Off
    
```

Prints the Filing Data settings.

◆ Data Logging Settings

```

Data Logging Settings List
Data Logging Settings
Trigger Settings Bit Method
Data Logging Start Address D000
No. of Words 1
Read Count 1
Block Count 1
ELC Trigger Bit Address X0000
OP ACK Bit Address X0000
File Full Bit Address X0000
Data Clear Bit Address X0000

Display On
Row Settings
Display Block Name On
No. of Block Name Rows 2
No. of data Rows 2
No. of Calc. Rows 1
Column Settings
Display Block Name On
No. of Char./Item 5
No. of Data Col. 3
Data Char. Size h1(f)
No. of Char./Data 8
    
```

Prints the data logging settings.

◆ **Global D-Script List**

Prints the Global D-Script settings.

Global D-Script List						
DScript						
Identifier	00001					
Description	Global D-Script Test					
Data Type	Bin	Length	16 bit	Signed	Unsigned	
Trigger	Bit Rising ()					
Action	if () { } endif					
Identifier	00002					
Description	Global D-Script2					
Data Type	Bin	Length	16 bit	Signed	Unsigned	
Trigger	Bit Falling ()					
Action	if ()					

◆ **D-Script Function List**

Prints the D-script function settings.

DScript						
Identifier	00004					
Description	Handy D-Script					
Data Type	Bin	Length	16 bit	Signed	Unsigned	
Trigger	Bit Rising ()					
Action	if () { } endif					

◆ **Sound Setting List**

Prints the sound settings.

Sound Settings List	
No.1	
Bit Address	X000
Sound No.	Y (Internal)
On/press	Not On/press
Flaw/Stop	Play/ON
Title	
No.2	
Bit Address	0002
Sound No.	Y (Internal)
On/press	Not On/press
Flaw/Stop	Repeat/ON
Title	

◆ **Symbol List**

Symbol List	
Word Symbol	
A Line (1 -5)	D00100
A Line (6 - 10)	D00101
Bit Symbol	
B Line (1 - 5)	X00100
B Line (6 - 10)	X00101
Word Comment	
D00101	A Line Operating
D00100	A Line Stopped

The Symbol Editor's Symbol setting status is printed out.

◆ **Global Cross Reference List**

Global Cross Reference List	
Bit Address	Screen
X00000	B1, bit log
X00022	B4
X00023	B5
X00100	alarm message
X00101	alarm message
Word Address	Screen
D00000	data sampling
D00001	B1, B2

The entire Project's address designation status, such as via Tags, are printed out. This command is executed for all the screens in the Project.

■ **Screen Information**

◆ **Loaded Screen List**

Screen List		
1) Base Screen		
Screen	Description	Date/Time
B1	Start Up Screen	2/1/99 15:21
2) Keypad Screen		
Screen	Description	Date/Time
K5	Load Screen Test	2/1/99 15:56
3) Trend Graph Screen		
Screen	Description	Date/Time
T1	Trend Graph	12/9/98 18:41
4) Mck Screen		
Screen	Description	Date/Time
M1	Mck Screen	2/1/99 15:46

Prints a list of the screens loaded onto a specified screen.

◆ **Tag List**

Screen Information		998/12/4 15:39 B1	
Project Name	Factory B - 401 Test run		
Screen	B1	First Screen	
Tag List			
A Tag			
Name	Description	Monitor/Word Address	
0000	Alarm 1	0000	
G Tag			
Name	Description	Data Storage Address	Graph Type Display Direction
0000	Pmp 8 ON	0000	Bar Up

Prints a list of specified Tags.

◆ **Parts List**

Screen Information							08/12/ 4 15:41 B1
Project Name	Factory B - 4th Test run						
Screen	B1 First Screen						
Parts List							
Part ID	Description	Ger. Addr.	Nhit.	Nhit. Addr.	Funct.	Interlock Addr.	
B5_001		X000	Off	- - -	Bit Set	- - -	
B5_002	Rmp. D ON	X000	Off	- - -	Bit Set	- - -	

Prints a list of the Parts placed on a Base Screen.

◆ **Cross Reference List**

Screen Information				08/12/ 4 15:42 B1
Project Name	Factory B - 4th Test run			
Screen	B1 First Screen			
Cross Reference List				
Bit Address	Tag Name	Parts ID		
X000	K0000K0001,T0000,T0001	B5_001,B5_002		
Word Address	Tag Name	Parts ID		
0000	00000K0000,K0001,A0000	B5_001,B5_002		
X000	K0000K0001,T0000,T0001	B5_001,B5_002		

Prints the address designation for Tags. This function can be executed for several screens.

◆ **D-Script**

DScript						
Identifier	00001					
Description	Warning View					
Data Type	Bin	Length	16 bit	Signed	Unsigned	
Tripper	Bit Rising ([bM0001])					
Action	if () { } endif					

Prints the D-Script settings.

◆ **Screen Hard Copy**

Screen Information		08/12/ 4 15:44 B12																								
Project Name	Factory B - 4th Test run																									
Screen	B12 Aggregate Summary																									
Screen Image																										
<table border="1" style="width: 100%; height: 100%;"> <tr> <td style="text-align: center;">1</td> <td style="text-align: center;">2</td> <td style="text-align: center;">3</td> <td style="text-align: center;">4</td> <td style="text-align: center;">5</td> <td style="text-align: center;">6</td> <td style="text-align: center;">7</td> <td style="text-align: center;">8</td> <td style="text-align: center;">9</td> <td style="text-align: center;">10</td> <td style="text-align: center;">11</td> <td style="text-align: center;">12</td> </tr> <tr> <td style="text-align: center;">13</td> <td style="text-align: center;">14</td> <td style="text-align: center;">15</td> <td style="text-align: center;">16</td> <td style="text-align: center;">17</td> <td style="text-align: center;">18</td> <td style="text-align: center;">19</td> <td style="text-align: center;">20</td> <td style="text-align: center;">21</td> <td style="text-align: center;">22</td> <td style="text-align: center;">23</td> <td style="text-align: center;">24</td> </tr> </table>			1	2	3	4	5	6	7	8	9	10	11	12	13	14	15	16	17	18	19	20	21	22	23	24
1	2	3	4	5	6	7	8	9	10	11	12															
13	14	15	16	17	18	19	20	21	22	23	24															

Prints each type of screen.

Memo

The sound output, filing data (recipe), and logging functions are advanced features to use the GP with even higher performance. For the detailed information about these features, please refer to Tag Reference Manual. In addition, regarding the CF Card, the CF Card tool used on GP-PRO/PB III is described. For CF Card usage requirements as well as usage that is linked with other features, also refer to Tag Reference Manual.

10.1Sound Output
10.2Filing Data (Recipe)
10.3Logging
10.4CF Card
10.5 Creating/Transferring CF Memory Loader Tool
10.6 CF Memory Loader Tool

10.1 Sound Output

This feature outputs sound data from a speaker connected to the GP by turning ON a specified bit. Via Alarm or message sounds, information can be sent to operators even if they are not looking at the GP screen. In addition, this feature can be used for a variety of applications such as operation guides and multimedia information.

Reference *Tag Reference Manual, 4.1 Sound Output*



Sound settings can only be used with Digital's GP477R, GP577R and GP2000 (except GP-2300 and GP-2301) series units. Also, to output sound data from a GP77R Series unit, the optional Multi Unit (sold separately) is required.

10.2 Filing Data (Recipe)

Setting data that you have created and stored on the GP can be easily transferred to the PLC whenever necessary, using GP touch keys or by specifying bit addresses in the PLC. Also, Filing (Recipe) Data that has been transferred to the PLC can be then sent back to the GP, edited, and then transferred again to the PLC.

When using the GP77R series and GP2000 series, Filing Data stored in a CF Card can be transferred.

Reference *Tag Reference Manual, 4.2 Filing Data (Recipe) Function*

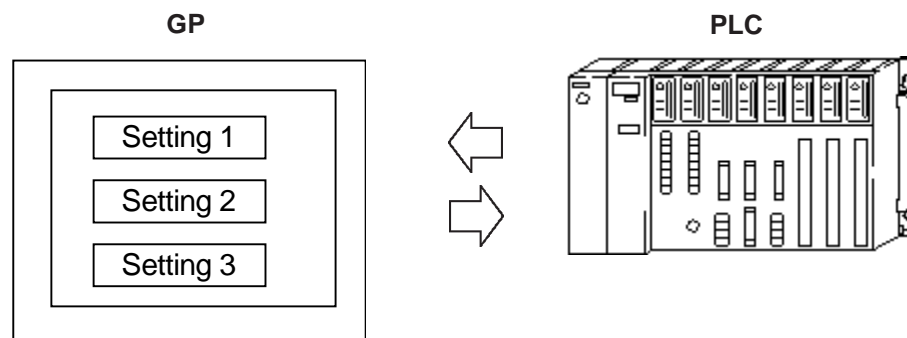

The Filing Data feature has been supported only by the GP-377 Series, GP77R series and GP2000 series. Also, to transfer Filing Data from the CF Card by the GP77R series, the Multi Unit (sold separately) is required.

10.3 Logging

The PLC data is loaded to the GP's backup SRAM at bit-based or time-specified timings to display it in a tabular form on the screen or print it on the printer.

The acquired data can also be integrated into a database so that it can be analyzed.

Digital's GP77R series and GP2000 series units enable you to save logged data as a CSV file onto a CF Card. The CSV file can then be sent from the CF Card to any PC, and its information used for a database, or displayed as a graph for analysis.

Reference *Tag Reference Manual, 4.3 Logging Function*



Use of the CF Card with a GP77R series unit requires the Digital's optional Multi Unit (sold separately).

10.4 CF Card

Digital's GP77R series and GP2000 series units all allow you to use the CF Card to store data.

The CF Card is intended primarily as an external storage device, for the storage of CSV files and backing up GP screen data.

For detailed CF Card information, refer to the Tag Reference Manual.

Reference *Tag Reference Manual, 4.4 Using the CF Card*

10.4.1 Using CF Card Tools

The use of the CF Card Tool enables you to copy data in your project's CF Card data output folder to the CF Card, as well as to copy data saved on the CF Card to the project. The data that can be copied using the CF Card Tool includes image screens, sound data, and Filing Data.



To use the CF Card Tool your PC must be equipped with a PC card slot.

■ Overview of the CF Card Tool

When you select the [Utility] menu - [CF Card Tool] option, the CF Card Tool is activated. The overview of the CF Card Tool is given below.

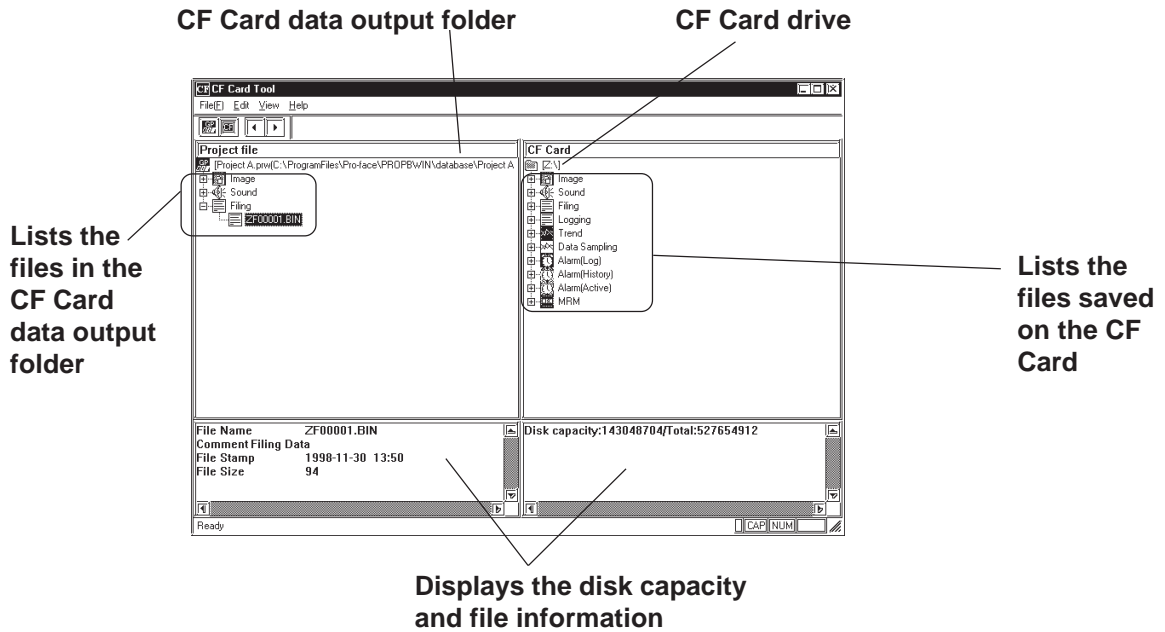

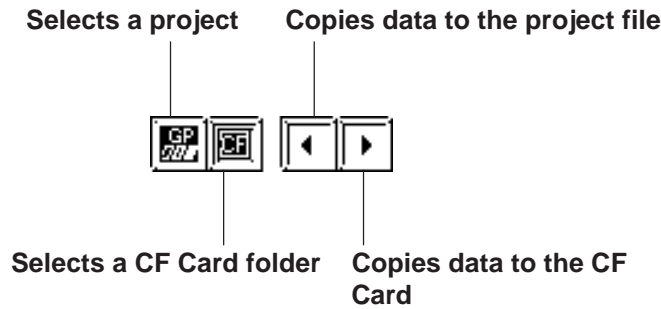

The toolbar icons have the following functions:



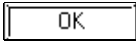
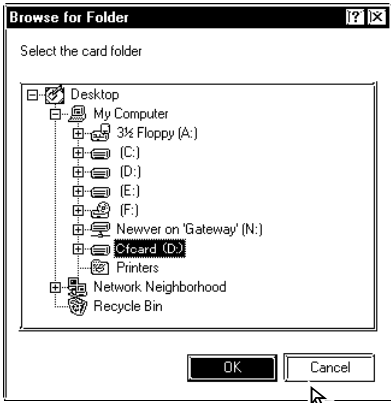
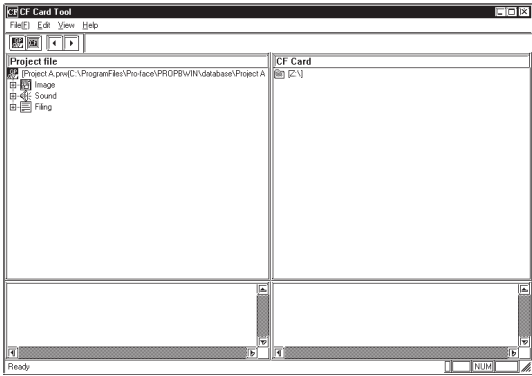

■ **Activating the CF Card Tool**

To use the CF Card, specify a drive for the CF Card on your PC.

PROCEDURE	REMARKS
<p>(1) Via the Project Manager, select the [Utility] menu - [CF Card Tool] command.</p> <p>(2) Specify a CF Card drive, and then click on the  button.</p> <p>The currently selected Project's information will be displayed in the left pane, and the CF Card's information in the right pane.</p>  <p style="text-align: center;">↓</p> 	<p>If any CF Card drive is already specified, the Browse for Folder dialog box will not be opened.</p> <p>To change the CF Card drive, click on the  icon, or select the [File] menu - [Select CF Card Folder] command.</p> <p>The information of the currently selected project is displayed in the left window, and that of the CF Card in the right window.</p>



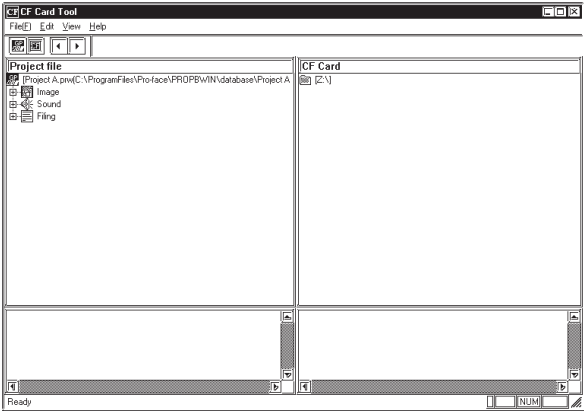

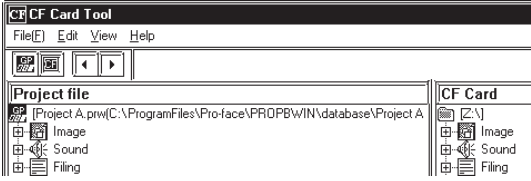
■ **Copying Data to the CF Card**

The data (image screens, sound data, and Filing Data) saved in the CF Card output folder can be copied from the project to the CF Card as follows.

PROCEDURE	REMARKS
<p>(1) Start the CF Card Tool.</p> 	<p>Reference ■ <i>Activating the CF Card Tool</i></p> <p>To change the CF Card drive, click on the  icon, or select the [File] menu - [Select CF Card Folder] option.</p>
<p>(2) Select the [Edit] menu - [Project to Card] command, or click on the  icon.</p> <p>The image screen, sound data, and Filing Data in the CF Card data output folder will be copied to the CF Card.</p> 	

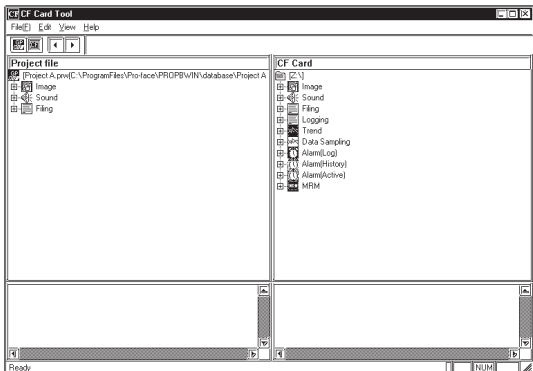
■ Copying Data to the Project

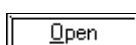
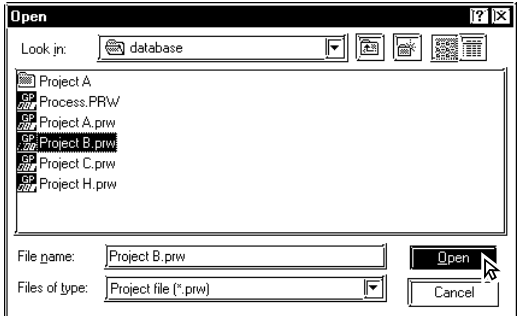
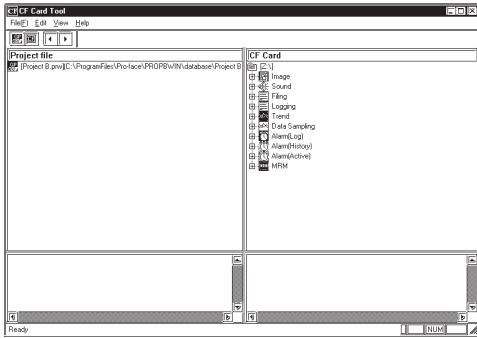
The data saved on the CF Card (image screens, sound data, and Filing Data) can be copied to the CF Card output folder for the project as follows.

PROCEDURE	REMARKS
<p>(1) Activate the CF Card Tool.</p>  <p>(2) Select the [File] menu - [Select Project] command, or click on the  icon.</p> <p>(3) Select the project file to which the data on the CF Card is to be copied, and then click on the  button.</p> <p>The selected Project's CF Card output folder will appear.</p>  <p style="text-align: center;">↓</p> 	<p>Reference ■ <i>Activating the CF Card Tool</i></p> <p>To change the CF Card drive, click on the  icon, or select the [File] menu - [Select CF Card Folder] option.</p>

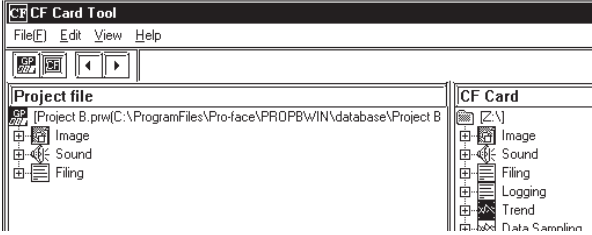
PROCEDURE	REMARKS
<p>(4) Select the [Edit] menu - [Card to Project] command, or click on the  icon.</p> <p>The image screen, sound data, and Filing Data saved on the CF Card will be copied to the specified project's CF Card data output folder.</p> 	<p>Only the image screens, sound data, and Filing Data will be copied from the CF Card. Other data (alarm data, trend graph data, sampled data, logged data, etc.) must be copied using Windows Explorer or other similar software.</p>

10.5 Creating/Transferring CF Memory Loader Tool

10.5.1 CF Memory Loader Tool / Backup Data

■ GP-PRO/PBIII to CF Card, then to GP (via “CF Card Tool”)

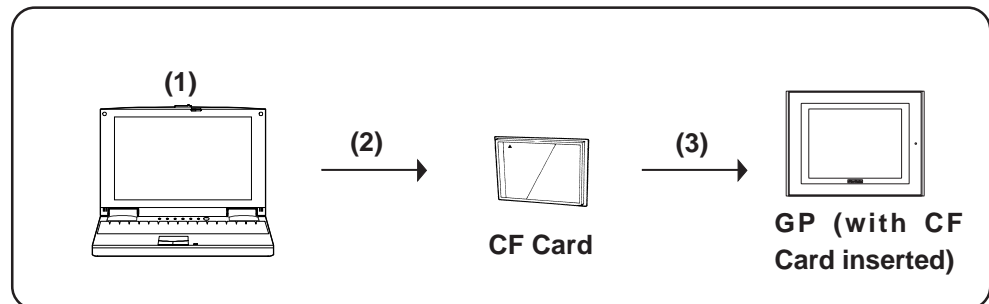

- (1) Creating backup data: Create GP backup data and “CF Memory Loader Tool” in the CF Card Data Output Folder.

▼ **Reference** ▲ *10.5.5 Creating Backup Data*

- (2) Copy data via “CF Card Tool”: Copy backup data in the CF Card Data Output folder and “CF Memory Tool” to the CF Card, using GP-PRO/PBIII’s “CF Card Tool” feature.

▼ **Reference** ▲ *10.5.8 Transferring “CF Memory Loader Tool” data via CF Card Tool*

- (3) Download data using “CF Memory Loader Tool”: Transfer the CF Card’s backup data to the GP.

▼ **Reference** ▲ *10.6 CF Memory Loader Tool*



The total space required for using Filing Data and Image Data in addition to the CF Memory Loader Tool and Backup Data is at least 8 MB. The capacity of the CF Card may be insufficient. Do not use the GP077-CF10 (8 MB) when using the CF Memory Loader Tool.

Name	Model Number
CF Card (16MB)	GP077-CF20
CF Card (32MB)	GP077-CF30

■ GP-PRO/PBIII to GP, then to CF Card

You can use this method for data transmission when your PC is not equipped with a CF Card I/F.

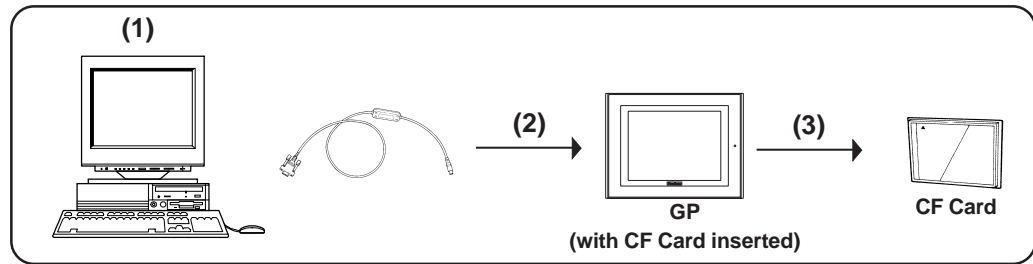

- (1) Create backup data: Create GP backup data and “CF Memory Loader Tool” in the CF Card Data Output Folder.

▼ **Reference** ▲ *10.5.5 Creating Backup Data*

- (2) Send backup data: Send backup data and “CF Memory Loader Tool” in the CF Card Data Output folder to the GP where the CF Card is inserted (GP “A”).

▼ **Reference** ▲ *10.5.6 Sending Backup Data*



Note: When using the GP data transfer cable (GPW-CB02), it will take approximately fifteen minutes to complete data transmission (when the baud rate is 115.2k bps).

- (3) Upload data using “CF Memory Loader Tool”: Transfer backup data in the GP to the CF Card.

▼ **Reference** ▲ *10.6 CF Memory Loader Tool*

- (4) Download data using “CF Memory Loader Tool”: After backup data is saved in the CF Card, insert that CF Card in a different GP (i.e. GP “B”) and then download your backup data to that GP from the CF card.

▼ **Reference** ▲ *10.6 CF Memory Loader Tool*

■ GP to CF Card, then to GP

Data can be copied from a GP to another GP unit.

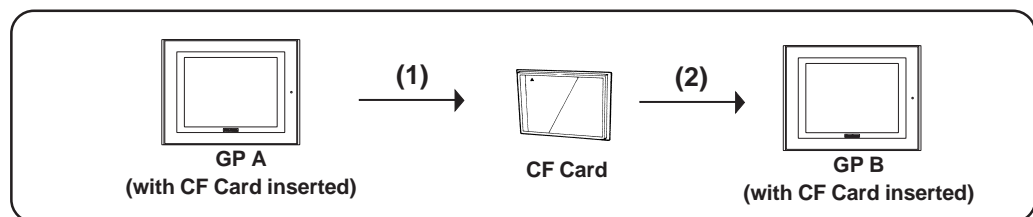



- (1) Upload data using the “CF Memory Loader Tool”. Transfer the backup data from the active GP unit to a CF Card.

▼ **Reference** ▲ *10.6 CF Memory Loader Tool*

- (2) Download data using “CF Memory Loader Tool”. Download your backup data to the GP from the CF card.

▼ **Reference** ▲ *10.6 CF Memory Loader Tool*

10.5.2 CF Memory Loader Settings

You need to call up the GP-PRO/PBIII [Transfer] screen to enter or use the CF Memory Loader's settings. To do this, select [Transfer] from the Project Manager's (main screen's) [Project] window, or click on the  icon. You can also select [Transfer] from the Drawing Area screen's [Screen] menu, or simply click on the  icon. The following explanation describes the [Transfer] screen's CF Memory Loader settings.

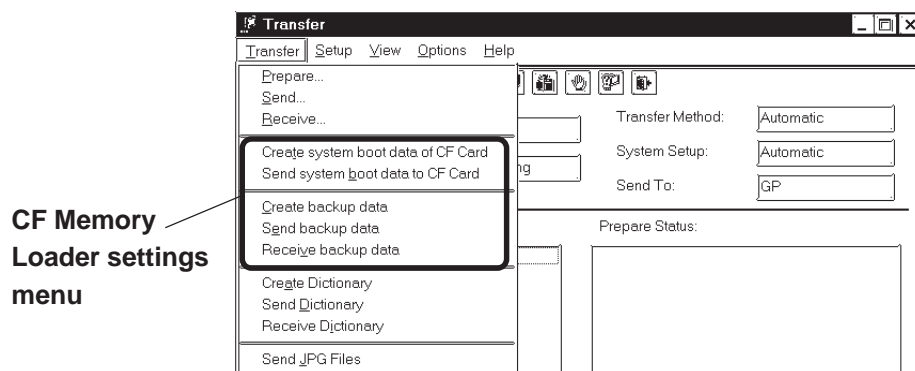

■ Create system boot data of CF Card

This feature allows you to create a copy of the "CF Memory Loader Tool" in the CF Card Data Output folder. Backup data creation, however, is NOT possible with this feature.

■ Send system boot data to CF Card

This feature allows you to download the "CF Memory Loader Tool" to your GP's CF Card from your GP's CF Card Data Output folder. Backup data creation, however, is NOT possible with this feature.

■ Create backup data

This feature allows you to create a copy of your GP backup data, as well as the "CF Memory Loader Tool", in the CF Card Data Output folder.

■ Send backup data

This feature allows you to download the CF Card Data Output folder's GP backup data and "CF Memory Loader Tool" to your CF Card.

■ Receive backup data

Transfers the backup data saved in your GP's CF Card to your PC's GP-PRO/PBIII software. However, the "CF Memory Loader Tool" itself cannot be transferred.

You can also select these features via the GP-PRO/PBIII Transfer Screen's toolbar icons.

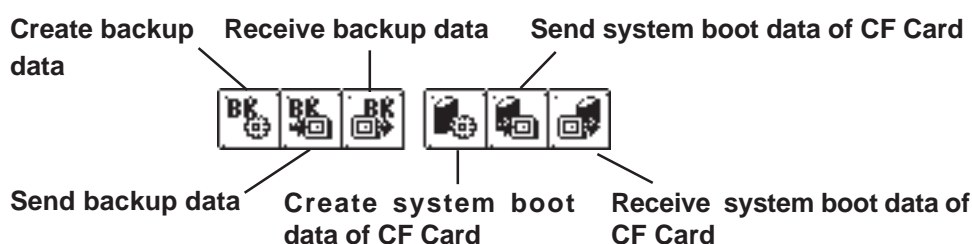



10.5.3 Creating System Boot Data for CF Card

To use the “CF Memory Loader Tool”, you need to first create (prepare) the “CF Memory Loader Tool “ (IPL.SYS, MLD****.SYS, GPBACKUP.INF) in GP-PRO/PBIII via the “Create system boot data of CF Card” feature, and download it to your GP’s CF Card. Then, upload the “CF Memory Loader Tool“ program data from the CF Card to the GP. The GP can then use the “CF Memory Loader Tool” saved on the CF Card. The following steps explain how to create the “CF Memory Loader Tool” in GP-PRO/PBIII.



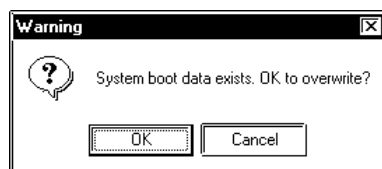

Note: The “*****” code in the above file name “MLD****.SYS” will vary according to the GP model.

GP Type	GP Code	GP Type	GP Code
GP2301HL	2240	GP2300T	2256
GP2301HS	2242	GP2400T	2261
GP2401H	2244	GP2500T	2266
GP2300L	2252	GP2501T	2267
GP2301L	2250	GP2600T	2276
GP2500L	226F	GLC2300L	225A
GP2301S	2251	GLC2300T	225E
GP2500S	226D	GLC2400T	2269
GP2501S	2268	GLC2600T	227E

PROCEDURE	REMARKS
<p>(1) Select [Transfer] from the Project Manager’s [Project] window, or click on  . (You can also select [Transfer] from the Drawing Board screen’s [Screen] menu or click on ).</p> <p>(2) Select the [Transfer] menu’s [Create system boot data of CF Card], or click on  . The “CF Memory Loader Tool” will then be created in the CF Card Data Output folder.</p>	<p>If the “CF Memory Loader Tool” is previously saved in the CF Card data output folder, the following window will appear. If you wish to overwrite it with new data, click on the [OK] button.</p> 

10.5.4 Sending System Boot Data to CF Card

This feature is used when transferring the “CF Memory Loader Tool” to the CF Card.

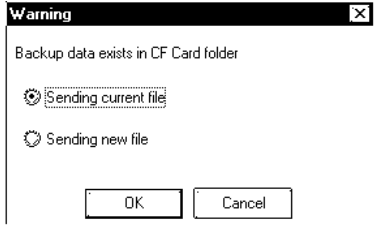
PROCEDURE	REMARKS
<p>(1) Select [Transfer] from the Project manager’s [Project] window, or click on . (You can also select [Transfer] from the Drawing Board screen’s [Screen] menu or click on ).</p> <p>(2) Select the [Transfer] menu’s [Send system boot data to CF Card], or click on . The “CF Memory Loader Tool” in the CF Card Data Output folder is then downloaded to the CF Card.</p>	<p>If there is a “CF Memory Loader Tool” previously saved in the CF Card data output folder, the following window will appear. If you wish to send the old (existing) “CF Memory Loader Tool” in the CF Card to the CF Card, select [Sending current file], if you wish to send the new data, select [Sending new file].</p> 



10.5.5 Creating Backup Data

Use this feature to create “CF Memory Loader Tool” and the GP’s backup data (BK****.MEM) that consists of system program data, screen data, expansion program data and communication protocol data.



Note:

- The “****” code in the above file name ” BK****.MEM” will vary according to the GP model.
- If you wish to send only "CF Memory Loader Tool" data to the CF Card, you do not need to create GP backup data. Simply use the [Send system boot data to CF Card] feature.
- Only one project’s backup data can be created in a single CF Card.

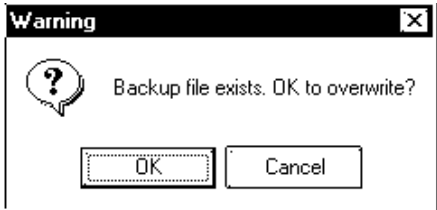
PROCEDURE	REMARKS
<p>(1) Select [Transfer] from the Project manager’s [Project] window, or click on . (You can also select [Transfer] from the Drawing Board screen’s [Screen] menu or click on ).</p> <p>(2) Select the [Transfer] menu’s [Send system boot data to CF Card], or click on . Backup data will then be created in the CF Card Data Output folder .</p>	<p>If there is backup data previously saved in the CF Card data output folder, the following window will appear. If you wish to overwrite the existing data in the CF Card with the new backup data, select [OK]. If not, select [Cancel].</p> 



10.5.6 Sending Backup Data

This feature allows you to send GP backup data created in the GP-PRO/PBIII to the CF Card. There are two methods, you can use:

Method 1: Transfer backup data from GP-PRO/PBIII directly to your PC's CF Card.

Method 2: Transfer backup data from GP-PRO/PBIII to a GP, then from the GP to that GP's CF Card.

The following section explains Method 2.

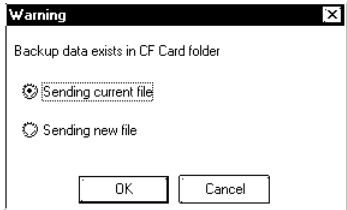
PROCEDURE	REMARKS
<p>(1) Select [Transfer] from the Project manager's [Project] window, or click on . (You can also select [Transfer] from the Drawing Board screen's [Screen] menu or click on ).</p> <p>(2) Select the [Transfer] menu's [Send backup data to CF Card], or click on . The backup data will then be transferred from your PC to the CF Card Data Output folder.</p>	<p>If the connected GP unit is not a GP2000 Series unit, the backup data transfer error message will appear and the backup data cannot be transferred. If there is backup data previously saved in the CF Card data output folder, the following window will appear. If you wish to overwrite the existing backup data in the CF Card with the current project's backup data, select [OK].</p> 



10.5.7 Receiving Backup Data

Here the CF Card's backup data "BK****.MEM" is transferred from the GP to GP-PRO/PBIII in your PC. The received backup data cannot be directly opened as a Project file. Transfer the backup data to the GP unit and load the data from the GP unit. The received data are converted to a Project file (*.prw).



Note:

The "****" code in the above file name "BK****.MEM" will vary according to the GP model.

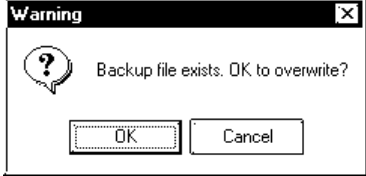
PROCEDURE	REMARKS
<p>(1) Select [Transfer] from the Project manager's [Project] window, or click on . (You can also select [Transfer] from the Drawing Board screen's [Screen] menu or click on ).</p> <p>(2) Select [Transfer]'s [Send system boot data to CF Card], or click on .</p>	<p>If there is backup data previously saved in the CF Card data output folder, the following window will appear. If you wish to overwrite the existing data in the CF Card with the new backup data, select [OK]. If not, select [Cancel].</p> 

10.5.8 Transferring "CF Memory Loader Tool" data via CF Card Tool

This feature allows you to confirm the type of backup data present, or copy data from GP-PRO/PBIII to the CF Card, and also from the CF Card to the GP-PRO/PBIII.

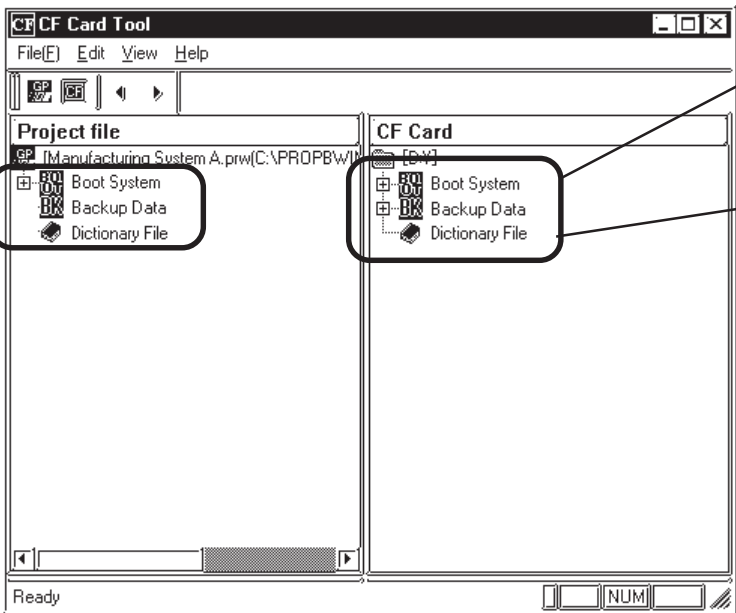

You can view the list of files saved in the CF Card data output folder here.

You can view the list of files saved in the CF Card here.

Here, the title of the project file created in the CF Card is shown. However, when the project file's backup data is created via the CF Memory Loader Tool, the title may not be shown here.



- **If there is no "CF Memory Loader Tool" data, the CF Card cannot be used as a system boot disk, and the boot system data will not appear in the CF Card Tool window. Also, if there is no backup data, it will not appear in the CF Card Tool window.**
- **In order to use the CF Card Tool, your PC must be equipped with a CF Card Slot.**



Note: If your PC is equipped with a CF Card Slot, using the CF Card Tool to transfer data to/from the CF Card is recommended since this transfer method takes less time than when using the GP.

10.6 CF Memory Loader Tool

10.6.1 About "CF Memory Loader Tool"

The "CF Memory Loader Tool" has the following features.

■ **UPLOAD**

This feature allows you to transfer all the GP's data to the CF Card.

■ **DOWNLOAD**

This feature allows you to transfer the CF Card's backup data to the GP.

■ **SYSTEM DATA DISPLAY**

View both the CF Card's backup data and the GP's data.

■ **COMPARISON**

Compare all GP data to the CF Card's uploaded backup data.

10.6.2 Starting the "CF Memory Loader Tool"

There are two methods for starting this program via the CF Card.

1. Menu Bar: Using the GP's [CF BOOT] menu

To call up the GP's menu screen, press point (1), and (2) with your right hand fingers. While holding these points, press point (3) with your left hand finger. After the menu appears, touch the menu screen's [CF BOOT] selection and the GP will be reset. After it restarts, the CF card's "CF Memory Loader Tool" screen will appear.



You need to transfer "CF Memory Loader Tool" to the CF Card prior to starting the program via the CF Card.

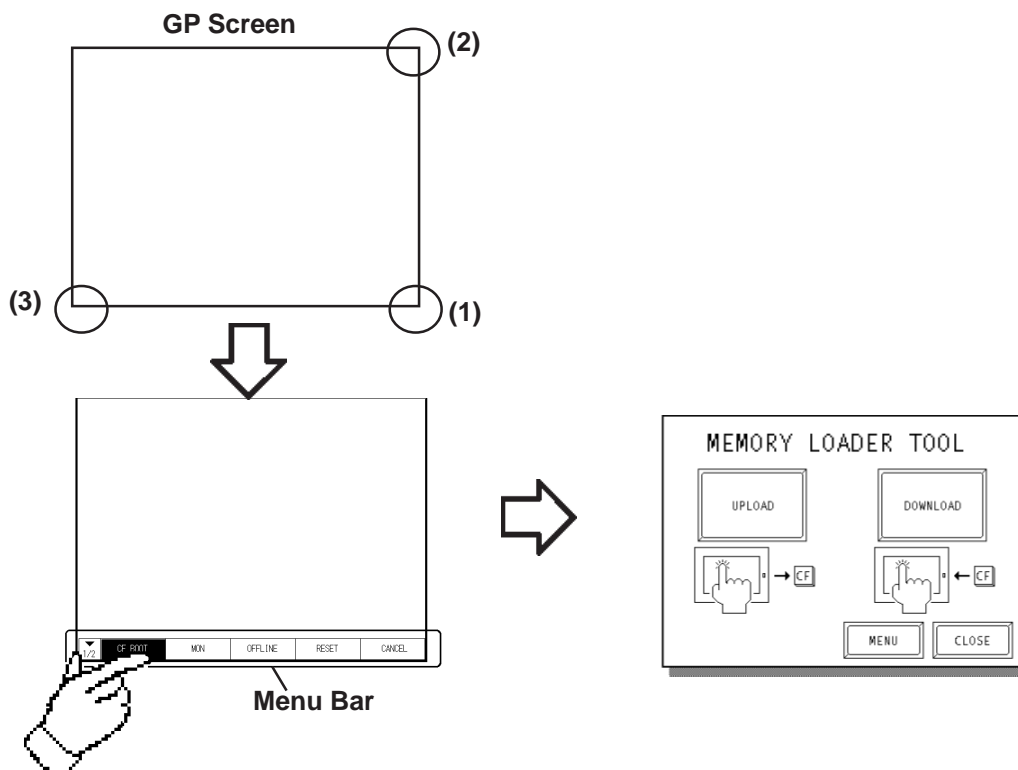

2. GP Dip Switches: Forced Start via GP Dip Switches

You can also use the Dip Switches on the rear of the GP, next to the CF Card Slot. If you turn ON Dip Switch No.1 (raise it) and then connect the GP's power cord, the "CF Memory Loader Tool" will start.



Note: To use the "CF Memory Loader Tool", it must be previously saved to the CF Card. Therefore, be sure to create the "CF Memory Loader Tool" on your PC with the GP-PRO/PBIII and transfer it to your GP's CF Card prior to using this program.

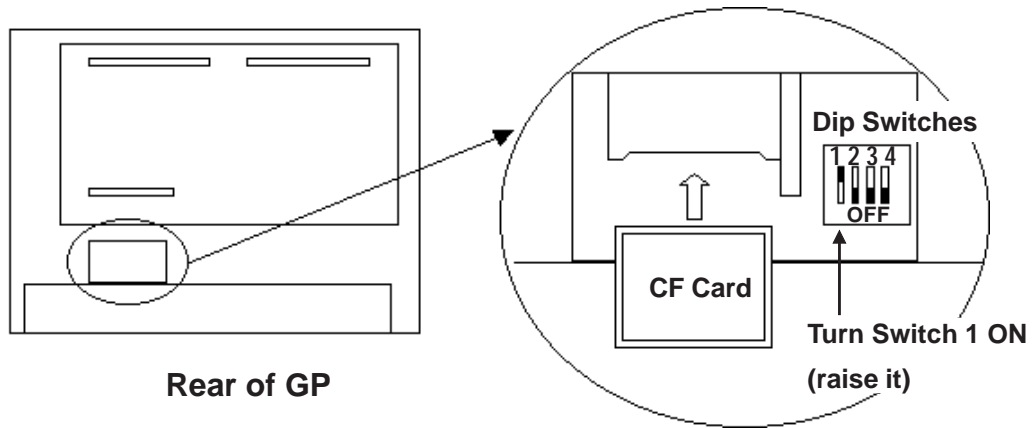

10.6.3 MEMORY LOADER TOOL

When the Memory Loader Tool program is started, the following screen will appear.

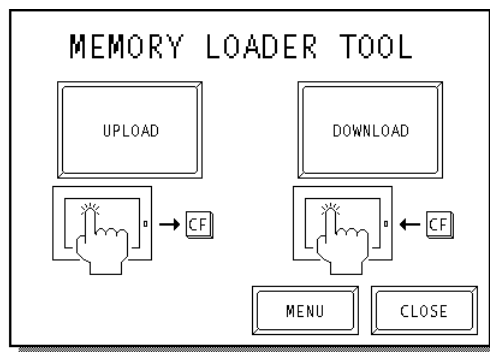

■ **UPLOAD (From GP to CF Card)**

This feature is for saving all GP data (i.e. system program, communication protocol, expansion program, screen data and Backup SRAM data) in the CF Card.



When UPLOAD is performed, the CF Card's current Backup Data will be completely overwritten.

■ **DOWNLOAD (From CF Card to GP)**

This feature is for writing CF Card backup data to the GP's Internal Memory.



When DOWNLOAD is performed, the GP's Internal Memory data (i.e. system program, communication protocol, expansion program, screen data and Backup SRAM data) will be completely overwritten.

■ MENU

Touching this button changes to the Menu screen.

■ CLOSE

Touching this button finishes the program and resets the GP.



If you touch the CLOSE button and the GP's rear face #1 Dip Switch is turned ON, the "CF Memory Loader Tool" will automatically start again when the GP starts up. Therefore, to finish the CF Memory Loader operation, you need to first turn #1 Dip Switch OFF or remove the CF Card from the GP, then touch the CLOSE button.

10.6.4 Menu Screen

If you touch the [MENU] button, the following screen appears.

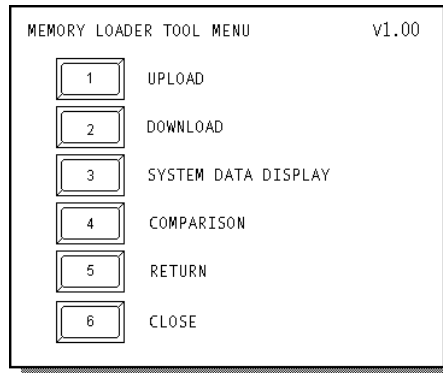

1. UPLOAD (from GP to CF Card)

PROCEDURE	REMARKS
<p>(1) Touch [1 UPLOAD] on the MEMORY LOADER TOOL MENU screen and the following screen will appear.</p> <p>(2) Enter your password using the screen's keypad.</p> <p>(3) Touch [START] and data upload will start.</p>	<p>Enter the password you have registered in GP-PRO/PBIII' s [Transfer] screen. If you have not registered a password, simply touch [START], and data upload will start.</p>

■ UPLOAD Status

Once upload starts, the UPLOAD status screen will appear.

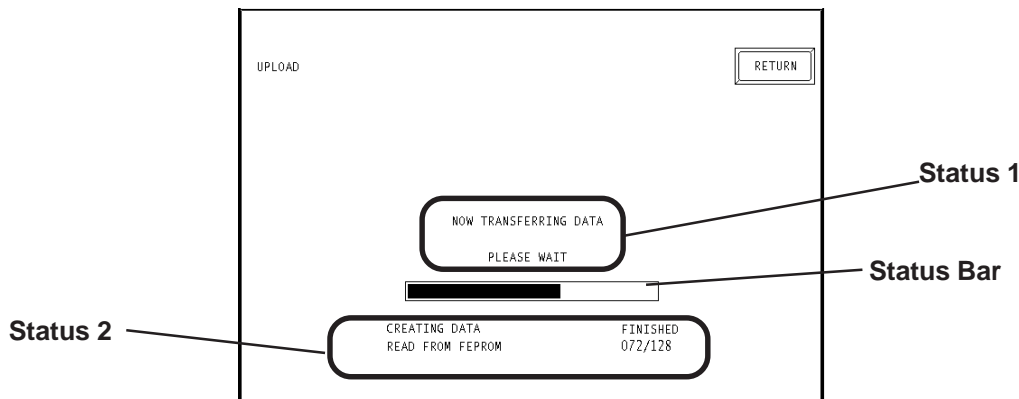

◆ Status 1

The message “NOW TRANSFERRING DATA PLEASE WAIT” will appear. If an error is detected during upload, an error message will appear.

◆ Status 2

UPLOAD Status information consists of the following data.

- Creating data (GP internal data)
- Read from FEPRM data (i.e. system program, communication protocol, expansion program, screen data and Backup SRAM data)
- Read from Backup SRAM data



Note: Each “block” in the UPLOAD Status Bar represents 64K bytes of data.

◆ Status Bar

The Status Bar shows the progress of the upload.

◆ RETURN

If you perform UPLOAD from the INITIALIZE screen, touching this button returns you to the INITIALIZE screen. If you perform UPLOAD from the MENU screen, the screen will return to the MENU screen.



WARNING

- **Be sure to check if the GP’s CF Card Access LED is turned OFF prior to inserting/removing the CF Card since there is a danger of loss of CF Card data**
- **While a CF Card is being accessed, DO NOT disconnect the GP power cord or reset the GP, or insert/remove the CF Card.**



Performing UPLOAD completely overwrites the CF Card’s current Backup data.

2. DOWNLOAD (from CF Card to GP)

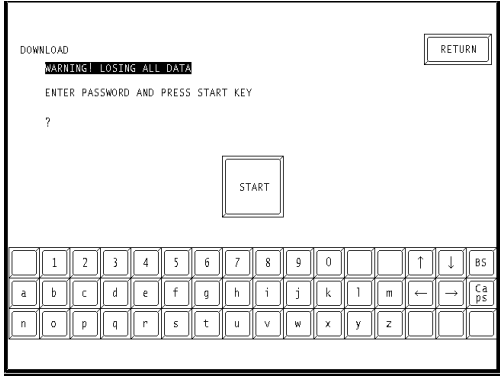
PROCEDURE	REMARKS
<p>(1) Touch [2 DOWNLOAD] on the MEMORY LOADER TOOL MENU screen and the following screen will appear.</p>  <p>(2) Enter your password using the screen's keypad.</p> <p>(3) Touch [START] and data download will begin.</p>	<p>Enter the password you have registered in the GP-PRO/PBIII's [Transfer] screen. If you have not registered a password, simply touch [START] and data download will start.</p>

■ **DOWNLOAD Status**

Once download starts, the DOWNLOAD status screen will appear.

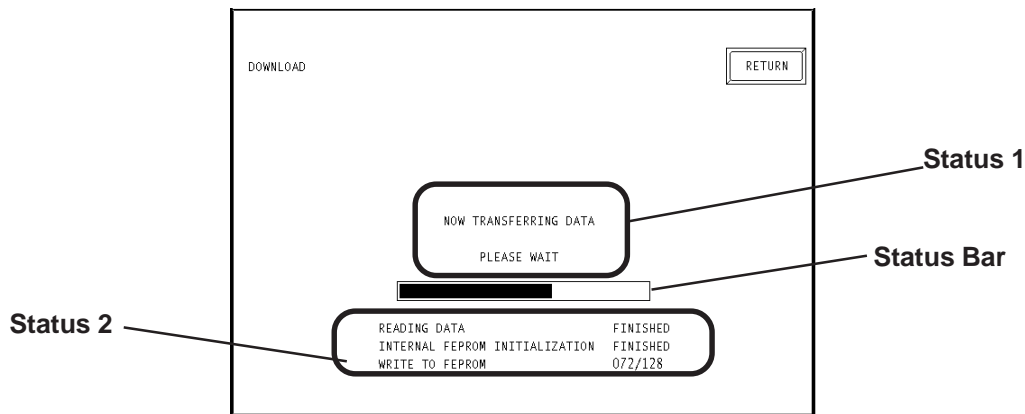

◆ **Status 1**

The message “NOW TRANSFERRING DATA PLEASE WAIT” will appear. If an error is detected during download, an error message will appear.

◆ **Status 2**

DOWNLOAD Status information consists of the following data.

- Reading data (GP internal data)
- Initialize Internal FEPRM data
- Write to Internal FEPRM data
- Write to Backup SRAM data



Note: Each “block” in the DOWNLOAD Status Bar represents 64K bytes of data.

◆ **Status Bar**

The Status Bar shows the progress of download.

◆ **RETURN**

If you perform DOWNLOAD from the INITIALIZE screen, touching this button returns you to the INITIALIZE screen. If you perform DOWNLOAD from the MENU screen, the screen will return to the MENU screen.



WARNING

- **Be sure to check if the GP’s CF Card Access LED is turned OFF prior to inserting/removing the CF Card since there is a danger of loss of CF Card data.**
- **While a CF Card is being accessed, DO NOT disconnect the GP power cord or reset the GP, or insert/remove the CF Card.**



Important

Performing DOWNLOAD completely overwrites all data (the System, Communication Protocol, Extended Programs, Screen Data and Backup SRAM Data).

3. SYSTEM DATA DISPLAY

If you touch [3 SYSTEM DATA DISPLAY], the following screen will appear.

Here, you can see details of both the CF Card’s uploaded data and the GP’s internal data. If you wish to see GP internal data details, touch the [INTERNAL] button.

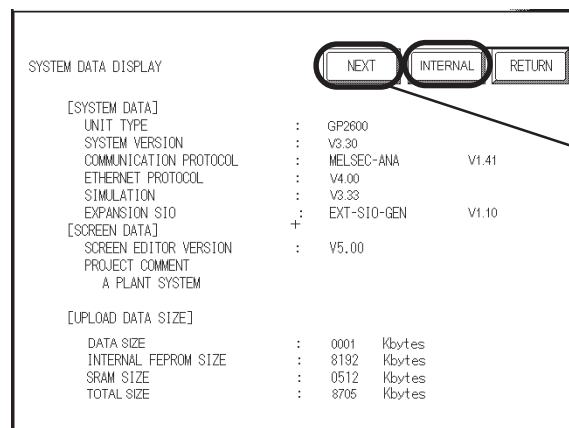

Displays the CF Card's uploaded data details.

Displays the control information of the GLC's internal data when the selected GP type is a GLC.

Reference *Pro-Control Editor Operation Manual*

The following are System Data Display examples.

■ **SYSTEM DATA DISPLAY (CF CARD'S DATA)**

This screen allows you to check the CF Card's uploaded data.

◆ SYSTEM DATA	<Display Example>
UNIT TYPE	:GP2600
SYSTEM VERSION	:V3.30
COMMUNICATION PROTOCOL	:MELSEC-ANA V1.41
ETHERNET PROTOCOL	:V4.00
SIMULATION	:V3.33
EXPANSION SIO	:EXT-SIO-GEN V1.10



- The "SIMULATION" data will change to "LADDER MONITOR" when there is a ladder monitor program.
- If there is no system program in the CF Card's uploaded data, the "SYSTEM VERSION" will be "NONE".

◆ SCREEN DATA	<Display Example>
SCREEN EDITOR VERSION	:V6.00
PROJECT COMMENT	:A PLANT SYSTEM (Up to 60 characters can be used)



If there is no Upload Information Data in the GP, an error message will appear informing you that there is no Upload Information Data, and the Screen Data will not be displayed.

◆ UPLOAD DATA SIZE	<Display Example>
DATA SIZE	:1K byte
INTERNAL FEPROM SIZE	:8192K bytes
SRAM SIZE	:512K bytes
TOTAL SIZE	:8705K bytes

■ **SYSTEM DATA DISPLAY (INTERNAL DATA)**

If you touch the [INTERNAL] button, the following screen will appear. You can check GP Internal data with this screen.

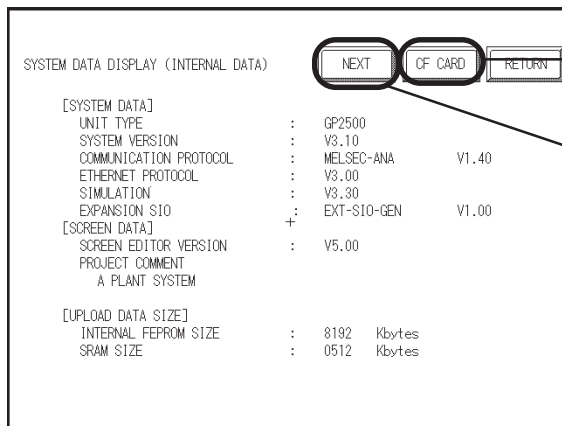

Displays GP internal data information

Displays the control information of the GLC's internal data when the selected GP type is a GLC.

Reference *Pro-Control Editor Operation Manual*

◆ SYSTEM DATA	<Display Example>
UNIT TYPE	: GP2600
SYSTEM VERSION	: V3.30
COMMUNICATION PROTOCOL	:MELSEC-ANA V1.41
ETHERNET PROTOCOL	:V4.00
SIMULATION	:V3.33
EXPANSION SIO	:EXT-SIO-GEN V1.10



Note: The “SIMULATION” data will change to “LADDER MONITOR” when there is a ladder monitor program.

◆ SCREEN DATA	<Display Example>
SCREEN EDITOR VERSION	:V6.00
PROJECT COMMENT	:A PLANT SYSTEM (Up to 60 characters can be used)



Note: If Upload Information Data is not transferred when transferring Screen Data, an error message informs you that there is no Upload Information Data, and the Screen Data will not be displayed.

◆ UPLOAD DATA SIZE	<Display Example>
INTERNAL FEPROM SIZE	:8192K bytes
SRAM SIZE	:512K bytes

4. COMPARISON

If you select [4. COMPARISON], the following screen will appear. This screen allows you to compare all the GP’s data (i.e. system program, communication protocol, expansion program, screen data and Backup SRAM data) with backup data that is uploaded in the CF Card.

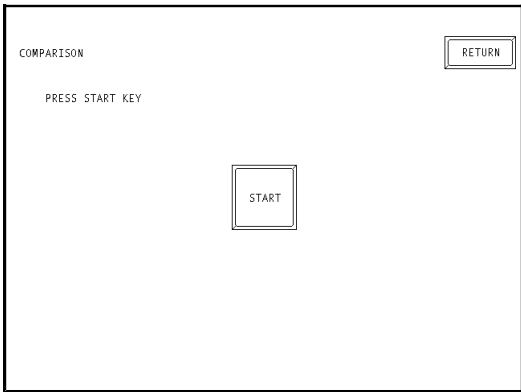
PROCEDURE	REMARKS
<p>(1) Touch [COMPARISON] on the MEMORY LOADER TOOL MENU screen and the following screen will appear.</p>  <p>(2) Touch the [START] button. The [COMPARISON] feature will compare all GP data with backup data that is uploaded in the CF Card.</p>	

■ COMPARISON Status

Once [COMPARISON] begins, the progress of the comparison can be seen on the following screen.

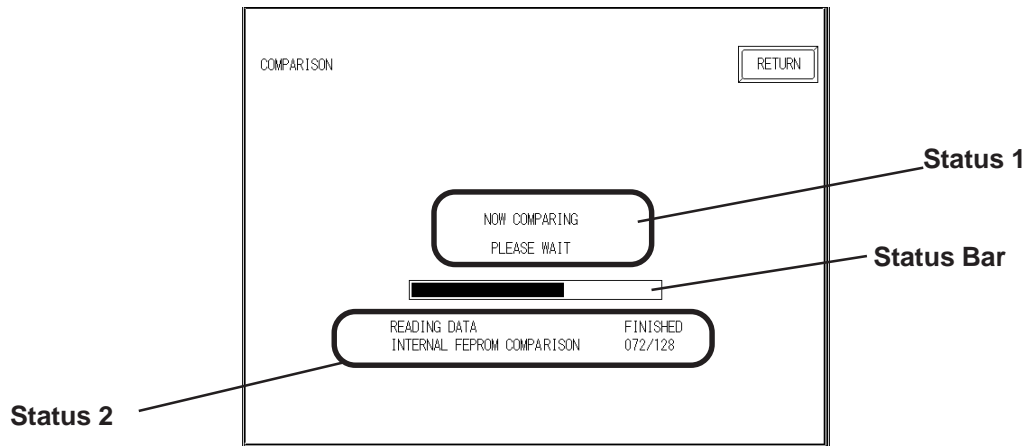

◆ Status 1

The message “NOW COMPARING PLEASE WAIT” will appear. If an error is detected during the [COMPARISON], an error message will appear.

◆ Status 2

COMPARISON Status information consists of the following data.

- Reading data (GP internal data)
- Comparing with Internal FEPRM data
- Comparing with Backup SRAM data



Note: Each “block” in the COMPARISON Status Bar represents 64K bytes of data.

◆ Status Bar

This bar shows the progress of the [COMPARISON].

◆ RETURN

Touching this button returns you to the MENU screen.

10.6.5 Self Diagnosis

You can check the CF Card's "CF Memory Loader Tool" using the OFFLINE mode's SELF DIAGNOSIS area. For example, if you touched three corners of the GP screen, selected [CF BOOT] on the Menu Bar and the CF Card failed to operate correctly, you can check the status of the "CF Memory Loader Tool" (i.e. IPL.SYS, MLD***.SYS) with this feature.

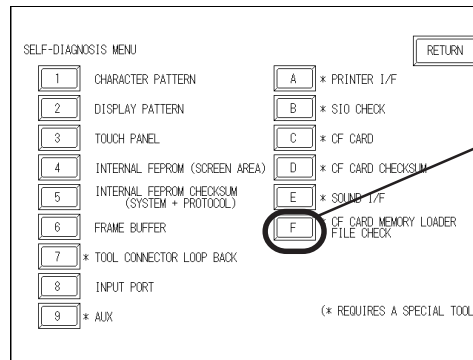

Calls up the CF Card Memory Loader file check screen.

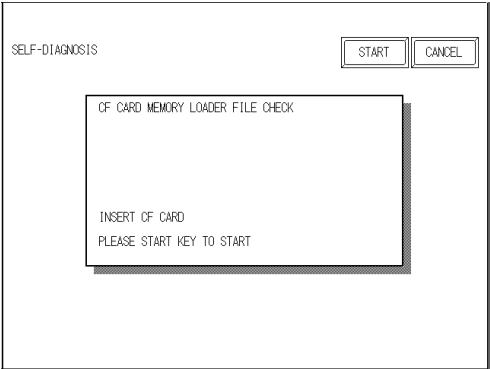
PROCEDURE	REMARKS
<p>(1) Touch [F CF CARD MEMORY LOADER FILE CHECK] and the following screen will appear.</p>  <p>(2) Touching [START] checks the following points.</p> <ul style="list-style-type: none"> • The status of the CF Card Start Dip Switches • Whether the "CF Memory Loader Tool" is in the CF Card or not • If the CF Memory Loader program has errors 	



Memo

The Project Manager can display the hierarchical structure of Project Files and screens. This function enables you to easily view Project Files and screens when moving or copying. This chapter describes how to operate the Project Manager in the hierarchical display mode.

11.1 Project Manager - Hierarchical Display

11.2 Using Hierarchical Display Mode

11.1 Project Manager - Hierarchical Display

When you click on the  button or select the [Project] menu - [Change Project Manger] command of the Project Manger in the normal display mode, the Project Manager is switched to the hierarchical display mode. To return to the Project Manager's original display, select the [Project] menu - [Change Project Manager], or click on the  icon.

When the Project Manager is in the hierarchical display mode, the hierarchical structure of your personal computer's folders is displayed, and the folders/Project Files are listed.

Normally, the system displays the hierarchical structure of the Database folder where the GP-PRO/PB III program has been installed. When you select the [View] menu - [Show Folders] command, all folders stored in your personal computer can be displayed.

Project files are displayed as folders. Screens are located in each folder corresponding to the screen type. You can open a desired screen by simply double-clicking the screen name. The project file folder is indicated by the project file name and the specified Device/PLC type. Each screen name is displayed with comments, size, and the date/time of creation or edition.

When you double-click on a folder in the left box of the Project Manager, the contents of the folder will be displayed in the right box.

When you click on the [+] (plus) sign at the left of each folder, its sub folders will be displayed.

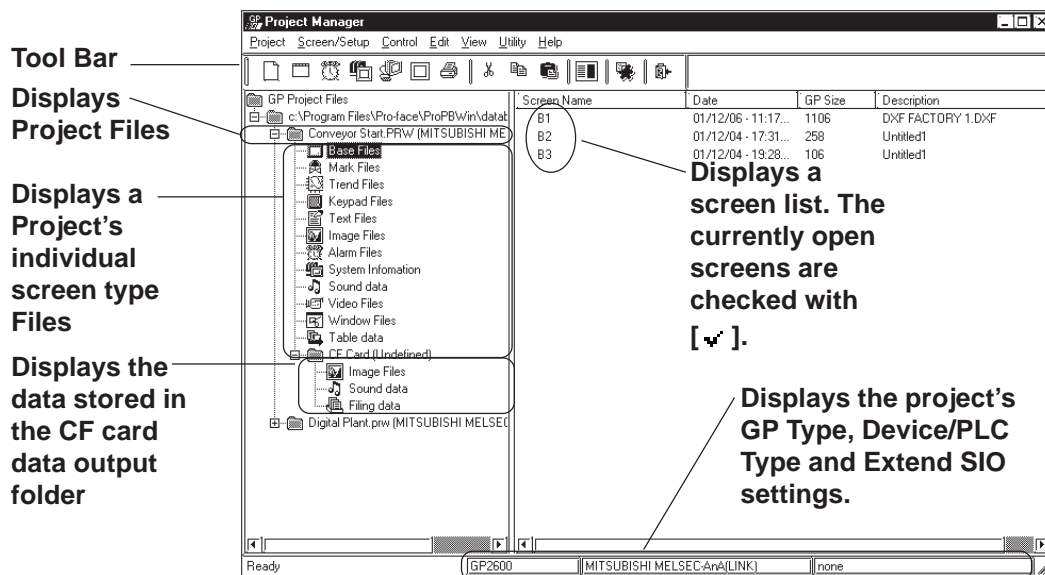

Important *If the Project Manager has been changed during the transfer of a screen to the GP unit, the transfer will be aborted. Do not change the Project Manager during the transfer of any screen.*

- Note:**
- To change the size of the left/right box displayed in the window, drag the border line between these boxes.
 - In the system information holder, a system information screen is displayed. Each system information screen can be copied to another project file by simply dragging it over that file's icon.

11.2 Using Hierarchical Display Mode

This section describes the basic operations of the Project Manager in the hierarchical display mode.

■ Creating a New Project

Click on the folder where you wish to create a new Project File. Select the [Project] menu - [New] command, or click on the  icon. The [New] dialog box will appear.

▼ Reference ▲ 1.1.2 ■ *Creating a New Project*

When a new Project File is created, a new folder “(new_project_name).prw” will be added to the directory.

■ Selecting a Project File from the Existing Projects

Click on the Project File to be selected. The right box lists the folders of the selected Project File by screen type.

■ Rename

To change a Project File name or screen name, select the target Project File or screen, and then select the [Project] menu - [Rename] command.

■ Opening a New Screen

Select a Project file. And then select the [Screen/Setup] menu - [New] command, or click on the  icon. The [New] dialog box will appear. Select the type of screen to be created and click on the button. Then, a new screen will open.

▼ Reference ▲ 1.1.3 ■ *Opening a New Screen*

■ Opening an Existing Screen

Select a Project file to create a screen. When selecting the [Screen/Setup] menu - [New] command, with the screen type folder specified, the [New] dialog box will appear with the specified screen type selected. Then, click on the button to open a new screen.

■ Opening a Screen

When you select the Project File including the target screen and then click on the folder corresponding to the target screen type, the screen name will be displayed at the right of the box. When you double-click on the target screen name, the Screen Editor will start up, and the selected screen will be opened. After selecting a desired screen, select the [Screen/Setup] menu - [Editor] command, or click on the  icon to open the screen.

When clicking on the  icon with the Project File selected, a dialog box to open a screen will appear. Select a desired screen and click on the button.

■ Copy

Select the target Project File or screen, and drag it to the destination folder. You can also copy it by selecting the [Edit] menu - [Paste] command after selecting the target Project File or screen and specifying the destination folder.

However, to copy a “screen type” folder or screen, drag it to a “Project File” folder or a folder of the same screen type.

■ Delete

Select the target Project File or screen, and then press the key or select the [Project] menu - [Delete] command.



If any project file has been edited by copying/deleting its data with the Windows Explorer, this edit will not be reflected in the hierarchical display of the Project Manager. In this case, update the details of the hierarchical display by selecting the [View] menu - [Refresh] command.

Screen data created with other screen editor software can be converted into files that can be used with the GP-PRO/PB III for Windows program.

12.1 File Converter

12.1 File Converter

Files created with other screen editor software (such as GP-PRO , GP-PRO II, GP-PRO III, and Parts Box) can be converted into files for use with the GP-PRO/PB III for Windows program.



Note: Project Files created with the GP-PRO/PB III program (DOS version) need not be converted. You can simply open your DOS files on the GP/PRO III for Windows program by selecting “DOS Project File (*.pro)” when specifying the project file type.

Once you save these files with the GP/PRO III for Windows program, they can be used with Windows.

Reference 1.1.2 ■ *Selecting an Existing Project*, ■ *Saving a Project*

Displays the original file to be converted



Displays a new file name and a comment

Displays the current conversion status

Displays the conversion progress

12.1.1 Conversion from GP-PRO II or GP-PRO III

Here, files created via GP-PRO II or GP-PRO III are converted to GP-PRO/PB III files (PRW files).

Usage Pattern			
[Start] → [Program] → [Pro-face] → [PROPB3Win] → [File Converter] →			
[File]	→	[Convert From GP-PRO 2/3 File]	→
or		Click on 	
	→	Select a file created with GP-PRO II or III.	→
	→	Specify the conversion range of the file.	→
[Actions] → [Convert]			
or			
Click on  to execute the conversion.			

■ **Selecting a GP-PRO II/III File**

Selects all the GP-PRO II and III screen files listed
Selects the screen file selected from the list
Cancel selection of the specified screen file
Cancel selection of all screen files
Lists the selected screen files
Displays the Device/PLC type specified for the GP-PRO II or III file







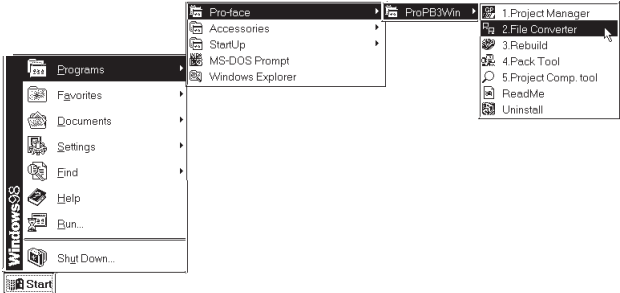

◆ **Selecting a Destination Folder**

Specify the Project File (PRW file) converted form the GP-PRO II or GP-PRO III file.

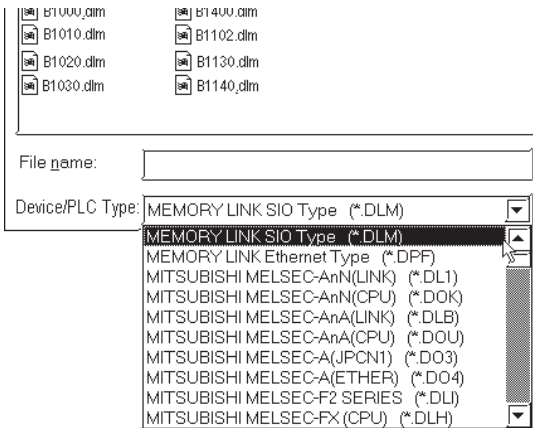

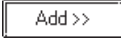
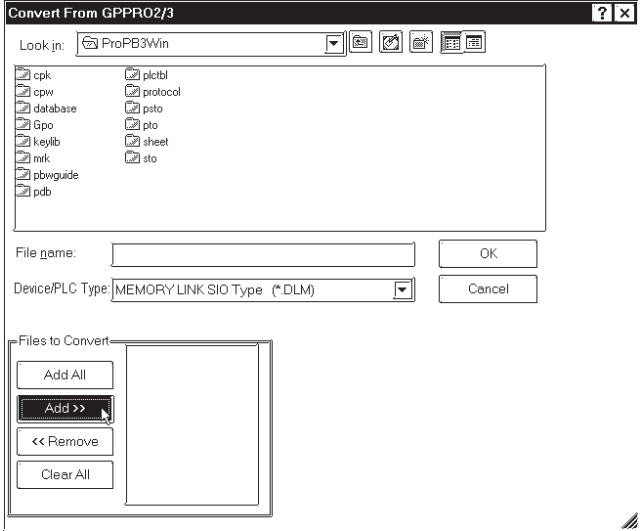
Creates a new Project File
Adds screen data into an existing Project File with the same file name

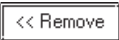
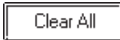
■ Converting a GP-PRO II/GP-PRO III File

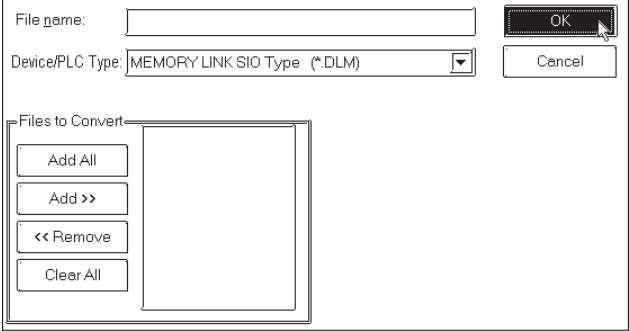
PROCEDURE	REMARKS
<p>(1) Click on the [Start] button, and point to the [Program] - [Pro-face] - [ProPB3Win] menu. Then, click on the [2.File Converter] command.</p>  <p>(2) Select the [File] menu - [Convert From GP-PRO 2/3 File] command, or click on the  icon.</p> <p>(3) Select a desired GP-PRO II or GP-PRO III file's Device/PLC type. The files corresponding to the selected Device/PLC type will be displayed.</p> 	

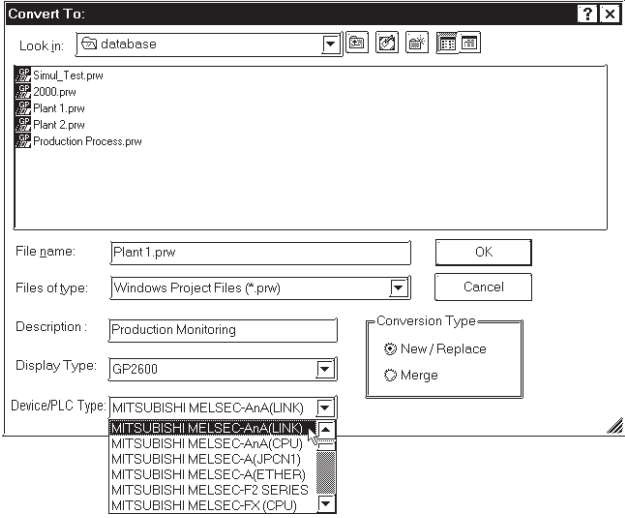
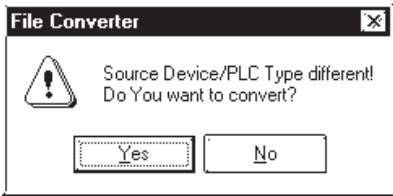
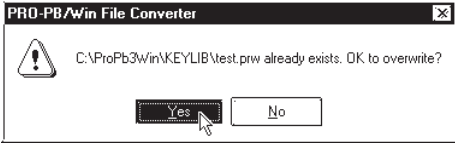
PROCEDURE	REMARKS
<p>(4) Select a desired GP-PRO II or GP-PRO III file or enter the file name, and click on the  button. The selected file will appear in the Files to Convert list.</p> 	<p>To convert all files, click on the  button.</p> <p>To cancel file selection, click on the  or  button.</p>
<p>(5) After selecting the GP-PRO II or III file, click on the  button.</p> 	

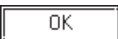
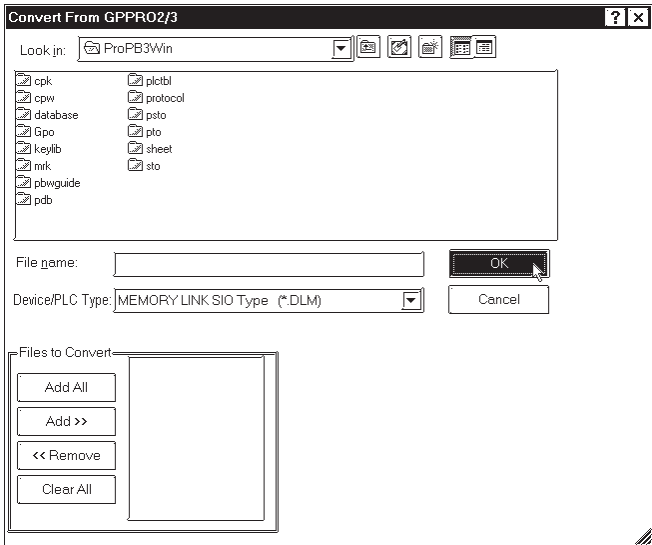
PROCEDURE	REMARKS
<p>(6) Enter the folder and Project File name where the converted file will be stored. Also, specify the GP and Device/PLC types.</p> <p>If the Device/PLC types are different before and after conversion, a dialog box will appear confirming the conversion command. If you wish to convert the file, click on the <input type="button" value="OK"/> button.</p>  <p style="text-align: center;">↓</p>  <p>(7) After confirming the conversion command, click on the <input type="button" value="OK"/> button.</p>	<p>To import a file from a different folder, first change the folder.</p> <p>Reference 1.1.2 ■ Selecting an Existing Project</p> <p>[Display Type] Select the GP unit type for the target Project File.</p> <p>[Device/PLC Type] Select the Device/PLC type for the target Project File.</p> <p>When the destination Project file's Device/PLC type is different from that of the original file, you must specify the Tag device address again after the Project File is imported.</p> <p>If the same file already exists, the system asks if this file must be overwritten. If you select <input type="button" value="Yes"/>, the file will be overwritten. If you select <input type="button" value="No"/>, the file will not be overwritten, and you will return to the previous dialog box.</p> 

PROCEDURE	REMARKS
<p>(8) Click on the  button to confirm the original and destination file settings.</p>  <p>(9) After confirming the settings, select the [Actions] menu - [Convert] command, or click on the  icon. The current status of the file conversion will be displayed. When the file conversion has been completed, “DONE” will be displayed in the status display area.</p>	





- After importing the system (SO) screen from GP-PRO II or GP-PRO III, be sure to check the [System Settings] data.
- When the system (SO) screen imported by the [Convert From GP-PRO 2/3 File] command is transferred to the GP70/77R/2000 series unit, you will need to perform [Font Setup]. Enter the GP's the OFFLINE mode, and set up the necessary fonts (language).

Reference *GP Series User's Manual (sold separately), FONT SETTINGS*

12.1.2 Conversion from Parts Box

Here, system files (SCD file) created via Parts Box are converted to GP-PRO/PBIII files (*.PRW).

Usage Pattern		
[Start] → [Program] → [Pro-face] → [ProPB3win] → [2.File Converter] →		
[File] → [Convert From Parts Box]	→ Select a file created with Parts Box.	→ Specify convert destination.
or click on 		
[Actions] → [Convert]		
or		
Click on 	to execute the conversion	

■ **Selecting a Parts Box File**

Displays the destination Project File (PRW file)

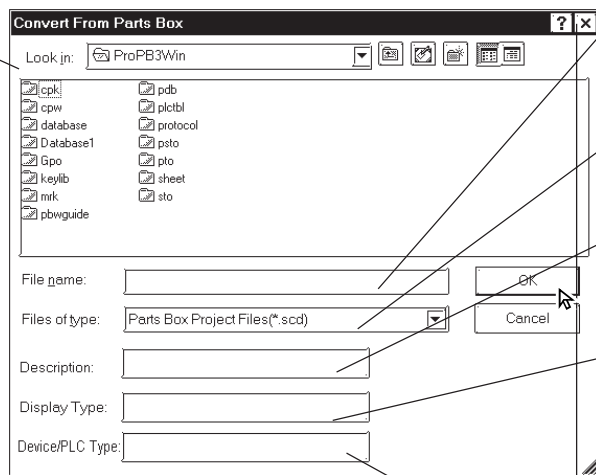

Select the SCD File and CPL File created with Parts Box

Displays Parts Box's system file (SCD file) and Library file (CPL file).

Displays a comment attached to the SCD or CPL file.

The Easy series name is automatically converted into the following GP series names :
 [Easy20] : GP-270 series
 [Easy40/50] : GP-470 series

Displays the Device/PLC type of the system file (SCD file)







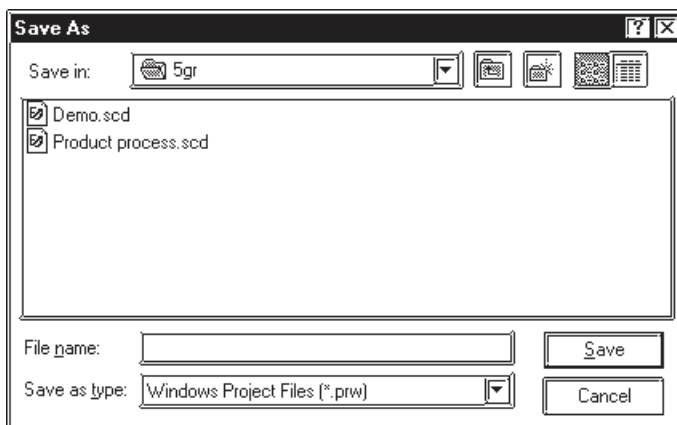

◆ **Selecting a Destination Folder**

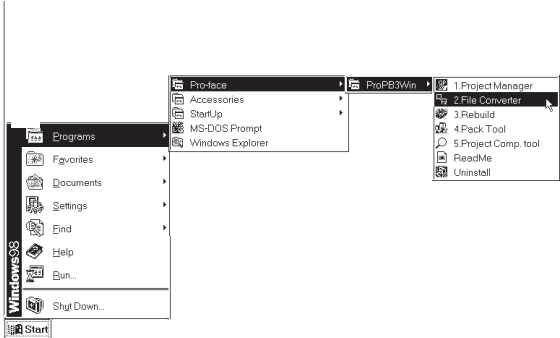
Specify the destination folder to store the Project File (PRW file) converted from the SCD file and CPL file.

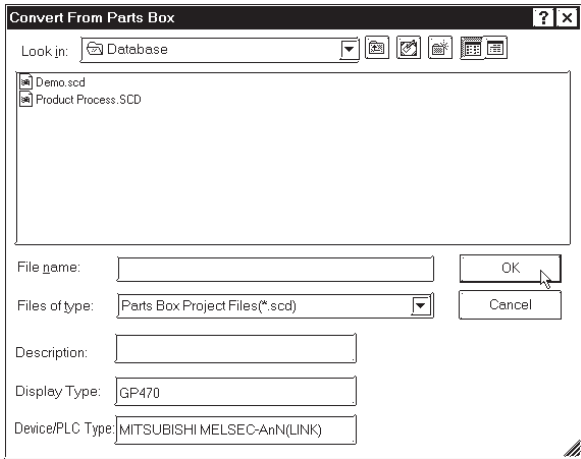

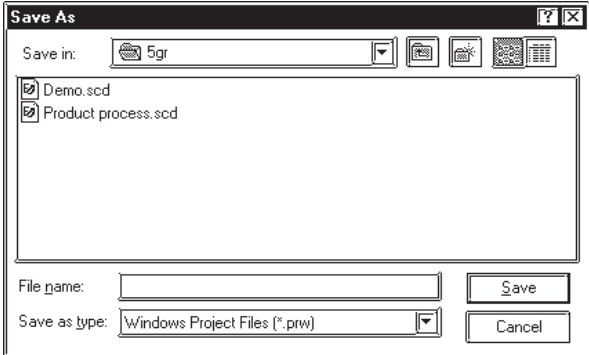
■ Converting a Parts Box File

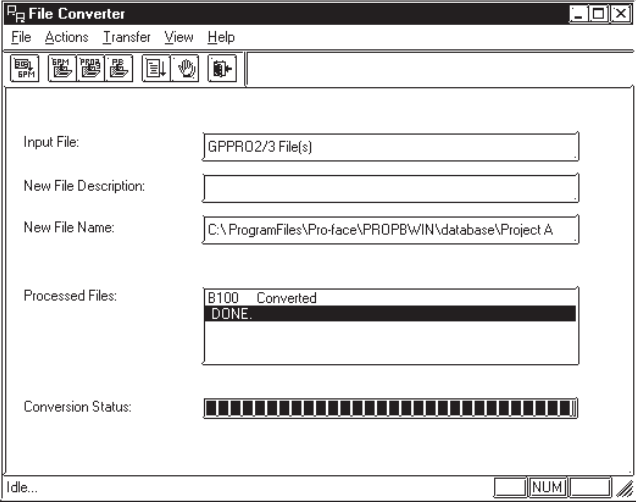

PROCEDURE	REMARKS
<p>(1) Click on the [Start] button, and point to the [Program] - [Pro-face] - [ProPB3Win] menu. Then, click on the [2.File Converter] command.</p> 	
<p>(2) Select the [File] menu - [Convert From Parts Box] command, or click on the  icon.</p> <p>(3) Select a Parts Box file to be converted or enter the file name, and click on the <input type="button" value="OK"/> button.</p> 	<p>To import a file from a different folder, you must change to that folder.</p> <p>Reference 1.1.2 ■ Selecting an Existing Project</p> <p>When selecting a Library file (CPL file), select [Parts Box Library File (*.cpl)] in the Files of type pull-down list.</p> 
<p>(4) Enter the folder and Project file name where the converted file is saved, and click on the [Save] button.</p> 	<p>To change the destination file's GP or Device/PLC type, do so after conversion.</p> <p>To import a file from another folder, change the folder.</p> <p>Reference 4.2.5 Changing a Project's GP Type, 4.2.6 Changing Your Project's Device/PLC Type</p>

PROCEDURE	REMARKS
<p>(5)After confirming the settings, select the [Actions] menu - [Convert] command, or click on the  icon. The current status of the file conversion will be displayed. When the file conversion has been completed, “DONE” will be displayed in the status display area.</p> 	

12.1.3 GP-*10 (GPM) File Conversion

Here, the GP-*10 Series' memory card data (GPM file) is converted to GP-PRO/PBIII's Project file (PRW file) for each memory card. Files created via GP-PRO cannot be converted directly to PRW files. First create GPM files, and then convert them to PRW files.

Reference 12.1.4 Reading GP-*10 (GPM) Files

Usage Pattern
<p>[Start] → [Program] → [Pro-face] → [ProPB3Win] → [2.File Converter] → [File] → [Select GP x 10 (GPM) File]</p> <p>or click on  → Select a GP-PRO file. → Specify conversion destination.</p> <p>[Actions] → [Convert]</p> <p>or</p> <p>Click on  to execute the conversion</p>

■ Screen Data After Conversion

◆ Screen names

After converting screen data created via GP-PRO to GP-PRO/PBIII screen data, the converted screen names are changed as follows:

Screen Type	GP-PRO	GP-PRO/PBIII
Base screen	1 to 255	B1 to B255
Library screen	300 to 699	B300 to B699
Mark screen	700 to 999	M700 to M999
Trend Graph screen	1000 to 1199	T 1000 to T 1199
Alarm Message	1200 to 1299	A1200 to A1299

◆ Tag names

Tag names will not be changed even after conversion. However, for l-tag and m-tag, "L" and "M" will be attached to the beginning of the original tag name, respectively.

■ Cautions When Converting GP-PRO Files

When converting GP-PRO files, be aware of the following cautions:

• Object displacement

Due to the high speed drawing of arcs and pies, as well as differences of drawing algorithms, GP-*10 screen coordinates data will be optimized. As a result, objects may be displaced from their original positions, which requires modification and correction.

• Color settings

Since color settings designated as "black + blink" are converted to "white + blink", re-set the color.

- **Chinese character fonts**

Chinese character fonts used on the GP-*10 series are different from the ones on the GP70/GP77R/GP377/GP2000 Series units.

- **Numeric keys**

GP-PRO/PBIII does not support N699. After conversion, re-create numeric keys and display on the GP-PRO/PBIII.

- **K-tag**

Since GP-PRO does not have a function to display data for K-tag, N-tag is used to enter set values via the screen's numeric keys. However, since GP-PRO/PB III supports the K-tag display function, the N-tag settings are not required.

- **System data areas +6 and +7**

The GP-*10 Series uses system data areas +6 and +7 for N699 numeric key entry and K-tag. However, the GP70/GP77R/GP377/GP2000 Series use +6 for status and +7 for reserved area, and K-tag reads and writes PLC data directly, without using the system data areas. When system data areas +6 and +7 have been used for the tags or ladder program, correct the address settings.

- **Requirements for 32-bit data**

Relationship between 32-bit data upper and lower addresses may be different between the GP-*10 Series and the GP70/GP77R/GP377/GP2000 Series, depending on Device/PLC types. Due to this, the PLC's ladder program may require correction.

- **Device/PLC type**

The data for Device/PLC types which are not supported by GP-PRO/PB III cannot be converted.

- **Data check after conversion**

Be sure to check all the settings such as of tags, after conversion.

■ **Selecting a GPM File**

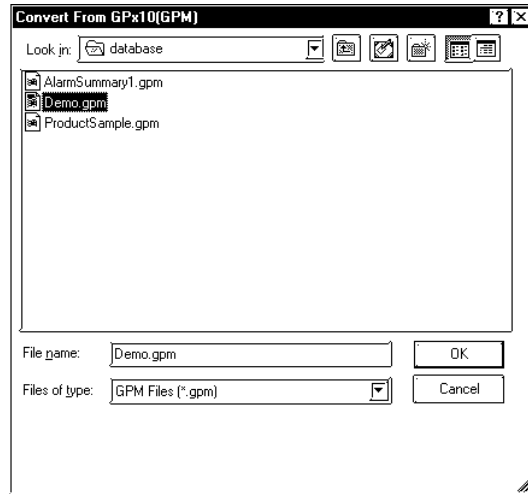

◆ **Conversion destination**

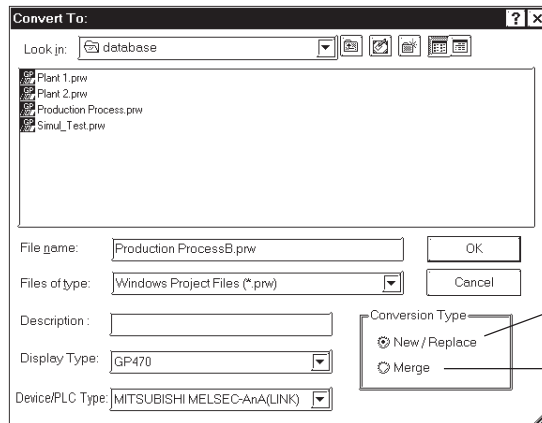

Specify the folder used to save the Project file (PRW file) converted from a GPM file.



Creates a new Project file.

Overwrites or adds screen data to the existing Project file with the same name.

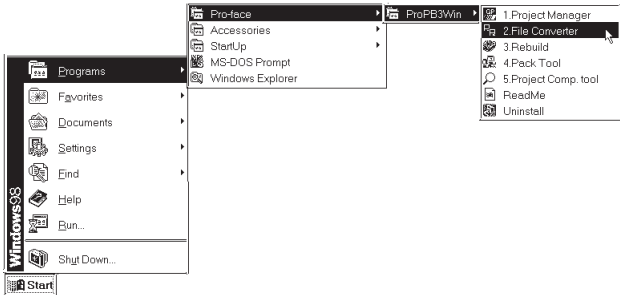
■ Converting a GPM File

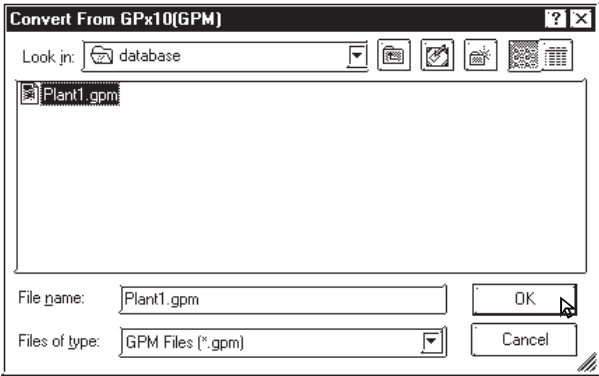
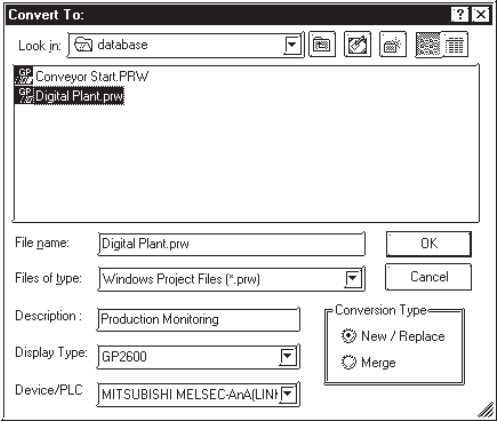
PROCEDURE	REMARKS
<p>(1) Click on the [Start] button and then select [Program] - [Pro-face] - [ProPB3Win] - [2. File Converter].</p> 	
<p>(2) Select the [File] menu - [Select GP x 10 (GPM) File] command, or click on the  icon.</p>	
<p>(3) Select a GPM file to be converted or enter the file name, and click on the <input type="button" value="OK"/> button.</p> 	
<p>(4) Enter the folder and Project file name where the converted data is stored. Also, specify GP and Device/PLC types.</p> 	<p>To import a file from another folder, change the folder.</p> <p>Reference 1.1.2 ■ Selecting an Existing Project</p> <p><i>When the destination Project file's Device/PLC type is different from that of the original file, you must designate all Tag device addresses again, after the Project File is imported.</i></p>

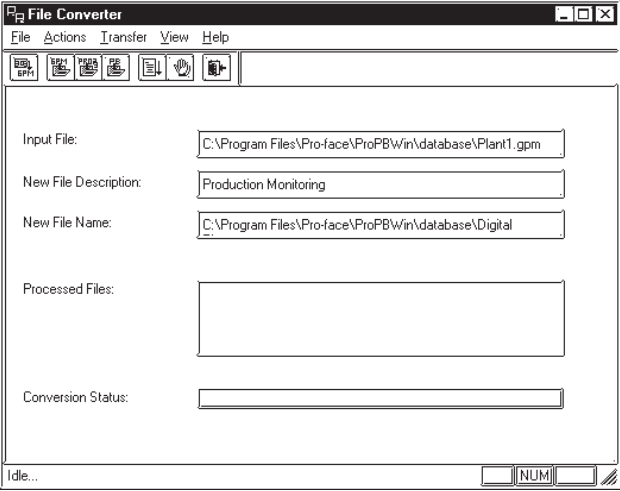
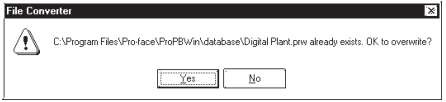
PROCEDURE	REMARKS
<p>(5) After confirming the settings, click on the <input type="button" value="OK"/> button.</p> <p>(6) After confirming the settings, select the [Actions] menu - [Convert] command, or click on the  icon. The conversion status will continuously be displayed. When "Completed" is displayed in the [Status] field, conversion is completed.</p>	<p>If the same file already exists, the system asks if this file must be overwritten. If you select <input type="button" value="Yes"/>, the file will be overwritten. If you select <input type="button" value="No"/>, the file will not be overwritten, and you will return to the previous dialog box.</p>
	

12.1.4 Reading GP-*10 (GPM) Files

Screen data transferred to the GP-*10 is received as GPM files. The received data files can be converted to GP-PRO/PB III Project files (PRW files) and used.



Reference 12.1.3 GP-*10 (GPM) File Conversion



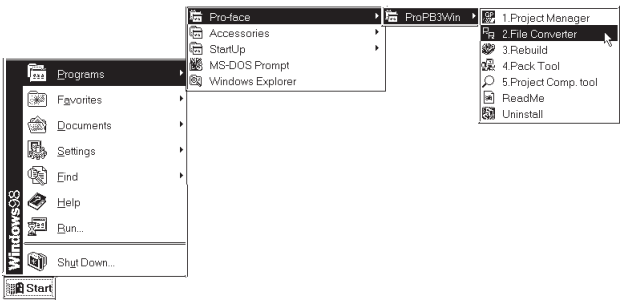

Note: A connector adapter is required to use a PC unit with a D-sub 9-pin socket interface.

Usage Pattern			
[Start] → [Program] → [Pro-face] → [ProPB3win] → [2.File Converter] →			
[Transfer] → [Load GPM File From GPx10]	→ Perform storage destination and communication settings.	→	Click on <input type="button" value="Yes"/> to execute the conversion.
or click on 			

■ Reading a GPM File

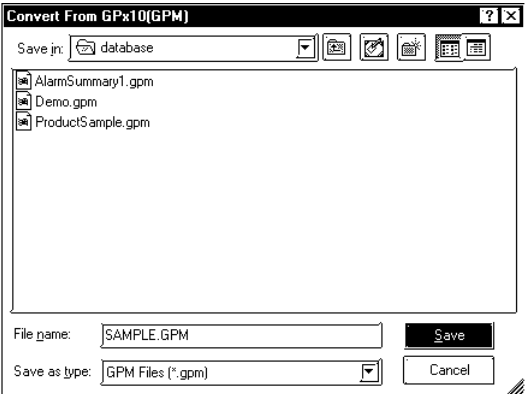
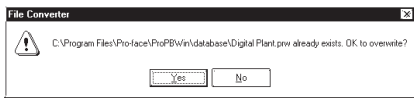
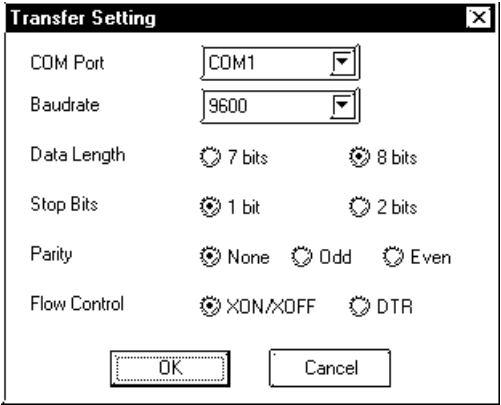
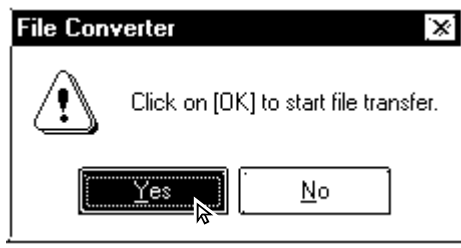
PROCEDURE	REMARKS
<p>(1) Click on the [Start] button and select [Program] - [Pro-face] - [ProPB3Win] - [2. File Converter].</p> 	<p>To receive data, connect the GP and personal computer via a cross cable. Digital's GP410-IS00-0 is available. Also, set the GP to transfer mode using the keyboard for drawing objects.</p>
<p>(2) Select the [File] menu - [Load GPM File From GPx10] command, or click on the  icon.</p>	

PROCEDURE	REMARKS
<p>(3) Specify a location (directory) to store the received data and the file name, and click on the <input type="button" value="OK"/> button.</p>	<p>If the same file already exists, the system asks if this file must be overwritten. If you select <input type="button" value="Yes"/>, the file will be overwritten. If you select <input type="button" value="No"/>, the file will not be overwritten, and you will return to the previous dialog box.</p>
	
<p>(4) Specify all the necessary communication items and click on the <input type="button" value="OK"/> button.</p>	<p>The communication settings must be the same as the GP's initial SIO settings.</p>
	<p>Sending Speed: 9600 bps Data Length: 8-bit Stop bit: 1-bit Parity bit: None Control Type: XON/XOFF</p>
<p>(5) Click on the <input type="button" value="Yes"/> button to start receiving data.</p>	
	

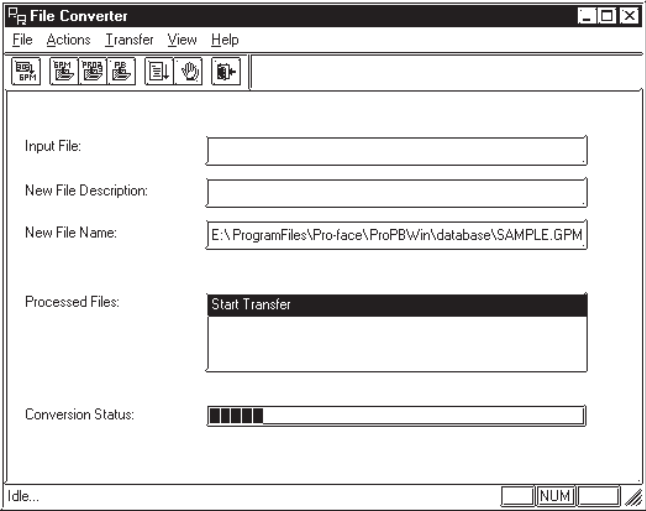
PROCEDURE	REMARKS
<p>(6) After confirming the data receiving command, select the [Actions] menu - [Convert] command, or click on the  icon.</p> <p>The conversion status will continuously be displayed. When "Completed" is displayed in the [Status] field, conversion is completed.</p> 	

APPENDICES

This section contains a list of error messages and corrective actions, as well as address conversion tables.

Appendix 1	Error Messages
Appendix 2	Troubleshooting
Appendix 3	Address Conversion Tables
Appendix 4	Software Trouble Report

A.1 Error Messages

■ Project Manager Errors

	Error Message	Cause/Solution
B	Be sure to check with the Network Coordinator to confirm your unique IP address. This is because if a duplicate IP address is used by any user, the entire network can be effected.	Click in the node IP address' edit box. Be sure to enter the node IP address carefully so that it does not duplicate any other device IP addresses.
C	Can't edit - Insufficient memory	The memory area for editing is insufficient. Quit other applications, then begin editing your file again.
	Cannot edit the files because the filing mode [Use Multiple Folders] setting is not selected! Click on [Use Multiple Folders].	When the filing mode settings' [Use Multiple Folders] was not selected, you attempted to open 2 or more kinds of filing data directly from the Project Manager having nesting screen display by double-clicking. Select [Use Multiple Folders].
	Cannot start up Internet browser	The browser settings are not correct or the memory area for the browser is insufficient. Check the settings of the startup browser. If the browser settings are correct, quit all other applications and restart the browser.
	Cannot read system file	The program file data required for setup cannot be opened or read, or the file's data is not correct. The file may be corrupt, or a disk error may have occurred. After solving the problem, reinstall the file.
	Cannot read the file's system information	The project file is corrupt. Use GP-PRO's rebuilding tool to repair the file. After repair is completed, read the file again.
	Channel numbers overlap!	Be sure channel numbers do not overlap and are unique.
	Current Color Depth Not Supported Convert to 256 colors or less	Only images of 256 colors or less can be used by this software.
	Current GP type does not support Device Monitor feature	Select a GP type which supports the device monitor feature.
	Current Device/PLC type does not support Device Monitor feature	Select a Device/PLC type which supports the device monitor function.
D	Destination screen number is too high. Reduce the number of destination or source screens	Set (Copy source end number - copy source start number) >= (8999 - copy destination start number).
E	Exceeds Data Backup Area Limit. Please adjust your settings to fit this area's size limitations	The backup settings, backup area used cannot exceed 2031. Set the backup start address + the number of devices to less than or equal to 2031.
	Exceeded limit for backup area setting of current GP type. Backup cannot be performed correctly with current setting.	Change the backup area setting to LS4096 or less.
G	Grouping Nesting Limit Reached. Unable to group more than these objects	You are attempting to nest grouped objects more than 10 times. Only 10 levels of nesting are allowed.
I	Internet Browser Not Selected Yet. Please select a Browser	An Internet browser has not been selected yet. After clicking on the error message's OK button, select a browser from the dialog box that appears.

	Error Message	Cause/Solution
I	Invalid Address !	Before entering the device address, check that the value is within the allowable range and that the device is supported by the PLC.
	Invalid PLC table	The PLC table file format is readable by the GP, or the file is corrupt or deleted. Select the Device/PLC type from the master disk and reinstall it.
	Incorrect PLC Table Format	The PLC table file format is not the same as the GP's, or the file is corrupt for some reason. Select a Device/PLC type from the master disk and reinstall the file.
N	Non-PRW File	A file has been selected that is not recognized by GP-PRO/PB III for Windows 95. Be sure to only select only Project (.PRW) files.
O	Old PLC table and some functions may not work properly. Please use latest table	The PLC table file from an old version is being used. Select a new Device/PLC type from the master disk and reinstall it.
	Older Version Project File Is it OK to upgrade the file? Upgrading a file means you will not be able to open the old version of the file.	An older version PRW file is now selected. If you click on OK and continue this sequence, the system will upgrade the existing PRW (i.e. create a new file) and change the old PRW's extension to POD. If Cancel is selected, the system leaves the file unchanged.
P	PLC File Type Error	The PLC table file format is not the same as the GP's, or the file is corrupt. Select a Device/PLC type from the master disk and reinstall the file.
S	Screen number to copy from must be greater than screen number to copy to.	Enter a "copy to" screen number that is greater than the "copy from" screen number.
	Selected project is the same as current project.	You cannot copy data within the same project file. Be sure to specify a project file other than the current project file.
	System error	The program file data required for setup cannot be opened and read, or the internal data is not correct. The file may be corrupt, or a disk error may have occurred. After fixing the problem, reinstall the file.
	System file is corrupt	The program file data required for setup cannot be opened and read, or the internal data is not correct. The file may be corrupt, or a disk error may have occurred. After fixing the problem, reinstall the file.
	System open error	The program file data required for setup cannot be opened and read, or the internal data is not correct. The file may be corrupt, or a disk error may have occurred. After fixing the problem, reinstall the file.
	System version error	The system cannot open this project file. You are attempting to open a file new version GP-PRO/PB III file using an old version of GP-PRO/PB III.

■ Project Manager Errors (from previous page)

	Error Message	Cause/Solution
S	System write error	The program file data required for setup cannot be opened and read, or the internal data is not correct. The file may be corrupt, or a disk error may have occurred. After fixing the problem, reinstall the file.
U	Unable to convert file. Please check disk.	The destination disk does not have sufficient free space. Prepare a disk that has sufficient space and re-try.
	Unable to read current project information	The project file is corrupt. Use the GP-PRO rebuilding tool to repair the file, and then read the file again.
	Unrecognizable Image File may be corrupted	The selected image file is either corrupted or unusable by this software.

■ Screen Editor Errors

	Error Message	Cause/Solution
B	Bitmap size is too large. The maximum bitmap size that can be registered is 160x160 pixels.	The maximum size of a bitmap that can be registered as an image Part is 160 dots x 160 dots. Be sure the image registered is within these limits.
C	Can't edit - Insufficient memory	The memory area is insufficient for editing. Quit all other applications and resume editing.
	Can't open more than 20 screens	The screen editor can have up to 20 screens open at one time.
	Cannot place screen on itself	You cannot call the screen being edited.
	Cannot register since this number is already being used by the U screen.	Delete the window screen.
	Change request will exceed maximum number of tags. Changes canceled	This change will exceed the tag upper limit. Reference ■ Number of Tags "2.3 Tags"
(Channel) Alarms cannot be used together with Fill Below Line in a channel setting.	When you attempted to use "Fill Below Line", you set the channel's Alarm feature "ON". Undo Graph Fill and reset the channel.	
D	Device address out of range	When the specified command is performed, the device address exceeds the upper limit. Specify an address within the allowable range.

	Error Message	Cause/Solution
E	Exceeded maximum GP file size. Changes canceled	This change will exceed the screen size upper limit. ▼ Reference ▼ ■ <i>Screen Size “1.1.3 Screen Types”</i>
	Exceeds A-tag limit	Only one alarm can be used on a single screen.
	Exceeds keypad limit	Only one keypad screen can be called to a Base screen.
	Exceeds a-tag limit	Only one alarm can be used on a single screen.
	Exceeds C-tag limit	Only one time display can be used on a single screen.
	Exceeds file size limit	The screen size exceeds the upper limit, and you cannot create any more graphic data. The last data created will become invalid. Store the screen data, and then open a new screen and call the stored screen using [Load Screen] in the [Draw] menu.
	Exceeds Part Library limit.	If the number of Part Libraries used exceeds the limit, Part Library data cannot be transferred to the GP. Reduce the number of Part Libraries. Reference ▼ Reference ▼ 2.1 <i>Parts, ■ Maximum Number of Automatically Created Part Libraries</i>
Exceeds R-tag limit	Only up to 30 R tags can be used on a single screen.	
F	Filing displays with the same ID No. cannot be placed on a screen if [Cursor Position Control] is selected.	Multiple filing displays with the same ID No. with [Cursor Position Control] selected cannot be placed on one screen. Either deselect [Cursor Position Control] or change each filing display ID No. so that the ID Nos. do not overlap.
	File write error	This file cannot be written to the destination media. Please check the designated drive name and directory.
	Fill Below Line can be used when only a single channel has been selected. Please delete any additional channels.	Two or more channels are preset for Fill Below Line. Set only one channel.
G	Grouping Nesting Limit Reached. Unable to group more than these objects	You are attempting to nest grouped objects more than 10 times. Only 10 levels of nesting are allowed.
H	High speed U-tag cannot be used if a standard U-tag is already in place.	Both the U tag and the use/non-use of high-speed settings must be specified. Do not duplicate the settings.
I	Invalid Screen (Number)	The effective screen number is within the range from 1 to 8999. Re-enter the screen number.
L	Large V tag will not work in the extend mode. Please reset this to the standard mode within the video settings of the GP system setup.	In the GP Setup area, select the Extended Setting tab's Video Settings "Standard Mode" setting.
O	Only one Q-tag sub display can be used per screen.	When using a Q-tag, the number of sub displays used is limited to 1.

■ **Screen Editor Errors (from previous page)**

	Error Message	Cause/Solution
P	Parts and tags are not valid objects.	A library item containing Parts or tags cannot be used in a Picture Display.
S	Screen No. is out of range. Re-enter a different Screen No.	Screen No. used after conversion is out of the Screen No. range. Enter the correct number.
	Small v tag will not work in the standard mode. Please reset this to the extend mode within the video settings of the GP system setup.	In the GP Setup area, select the Extended Setting tab's Video Settings "Extend Mode" setting.
	The sum total of all the data saved by the GP's data backup features now exceeds the backup memory unit's limit. Please reduce this amount.	The backup size exceeds the SRAM capacity. Reduce the number of sampling data, or set this item's backup setting to "None".
T	The area available for data sampling has been exceeded. Please re-enter this item's settings.	The storage address used exceeds 2031. Set the storage start address + the number of sampling data to less than or equal to 2031.
	The amount entered for the data sampling feature is combined with the number of Trend graph channels created, and their combined total cannot exceed 20.	When 20 channels are preset, the Add button is clicked in the data sampling setting list display dialog box. Delete unnecessary settings so that the total of Trend Graph channel settings and the data sampling settings will be within 20.
	The current GP type setting does not support video. Video tag will have no effect	Select the GP type for the VM Unit.
	The font used for this text cannot be found. Only font type and color can be changed.	The designated font cannot be found in the PC's Font folder. Either select a different font, or install the desired font.
	There are no screens created for this screen type.	The screen that you attempt to open cannot be created with the specified screen type. Open a new screen.
	The designated screen does not exist.	The screen that you attempted to open cannot be found in this project. Select a screen from different existing project.
	This object has a non-black background and may not display properly on the GP. Also, be sure that your loaded screen's center point is aligned with the object (loaded to) screen's center point.	If this screen is used as the screen for the background color, be sure to align its center point correctly with the destination screen.
	This rail number is already in use. Please enter another number.	All rail numbers used on a single base screen must be unique.
	This screen cannot be edited.	Delete the window screen.
	This tag does not support portrait mode. Continue anyway?	The vertical type GP does not support the tag that you are attempting to use.
U	Unrecognizable Bitmap File may be corrupted	The selected bit map file is either corrupted or unusable by this software.

■ Library Item Placement / Save Errors

	Error Message	Cause/Solution
G	Grouping Nesting Limit Reached. Unable to group more than these objects	You are attempting to nest grouped objects more than 10 times. Only 10 levels of nesting are allowed.
N	Not a library file	The library file selected in the library browser cannot be used in this system. Select a file with a CPW extension.
O	Out of memory	Memory is not sufficient to perform the operation. Quit other applications, re-allocate memory, and then restart the operation.
S	System error	An error occurs when the library file is being stored. Reserve sufficient free disk space and restart the operation.
T	This file was created using an old version editor and cannot be converted	The current file is a CPL file created in Parts Box. Use the file converter to convert the file into a CPW file.
U	Unable to convert memory block into cell	The memory is not sufficient to execute the operation. Quit other applications, re-allocate memory, and then restart the operation.
	Unable to create cell list	The library file is corrupt for some reason. Use the provided rebuilding tool to repair the file and then restart the list creation.

■ D-Script Errors

	Error Message	Cause/Solution
C	Constant value out of range:	The preset constant value exceeds the specified range. Enter a correct value.*
D	D-Script function name has not been entered. Please type the function's name in the description field.	Do not click OK without entering the function name; you must first specify the function name. Enter the function name.
E	Expression too complex. See HELP screens for assistance.	Simplify the D-Script expression.
I	if' expression requires a non-empty statement	An expression is required in { } in the if clause. If no expression is specified, the if clause is ignored.*
	Illegal Expression	The entered expression contains an error and will not be recognized.*
	Illegal syntax	The entered D-Script expression has a syntax error.
	Illegal address	The entered address setting contains an error. Enable the syntax help in the option setting menu and enter the address by clicking the icon, or enter it from the keypad.
N	Negative numbers not supported - select correct data type	A negative number cannot be used as a constant. Enter a positive number.*
T	This script expression is not legal (it will not download). Do you still want to register this data and quit the D-Script editor?	The preset D-Script expression has an error. Even if this script is registered, the operation will be not performed.
W	WARNING: Statement has no effect and has been removed	The entered instruction is ignored because it will not influence the expression.

* These messages are displayed only when the syntax check in the option setting menu is selected.

■ Alarm Editor Errors

	Error Message	Cause/Solution
C	Can't Add Messages - Insufficient memory	Memory is not sufficient to add the messages. Quit other applications, re-allocate memory and try to add the messages again.
	Can't import more basic alarm messages. Basic alarm message limit has been reached.	During message import, the number of Bit Alarm Log messages has exceeded the designated limit. Delete the messages currently set and adjust the setting range so that the messages to be imported can be stored.
	Can't import more log alarm messages. Log alarm message limit has been reached.	During message import, the number of Bit Alarm Log messages has exceeded the designated limit. Delete the messages currently set and adjust the setting range so that the messages to be imported can be stored.
	Can't import more word alarm messages. Word alarm message limit has been reached.	During message import, the number of Bit Alarm Log messages has exceeded the designated limit. Delete the messages currently set and adjust the setting range so that the messages to be imported can be stored.
D	Data in Blocks 2 and 3 cannot be uploaded to the GP.	Since the "Block" feature was turned OFF when this data was downloaded, please delete Blocks 2 and 3.
L	Low Memory - not all messages can be pasted!	Memory is not sufficient to paste all the messages. Quit other applications, re-allocate memory and paste the messages again.
	Low Memory - not all alarms were copied! Try copying a smaller group.	Memory is not sufficient to paste all the messages. Quit other applications, re-allocate memory and paste the messages again.
N	Not enough memory to perform undo! Do you want to continue?	Memory is not sufficient to undo the messages. The deleted message(s) cannot be undone (restored)
	Not all alarms were saved. Insufficient disk space	Disk capacity is not enough to store the data. Create more free disk space and store the data again.
	Not all alarms were read. Insufficient memory	Memory is not sufficient to read the alarm messages. Quit other applications, create more memory and read in the alarms again.
S	Since this GP model does not support the "Block" feature, Blocks 2 and 3 will be combined with Block 1 when the data is sent to the GP.	The setup is attempted on an incompatible model. This feature is disabled on this model GP.
	Some data is incorrect and all data cannot be imported.	The format of CSV data to be imported is incorrect. Data in and below the line with the incorrect data will not be imported. Check Alarm data's CSV format.

■ Symbol Editor Errors

	Error Message	Cause/Solution
A	Addresses cannot be used as symbol names!	Enter a standard address in the address column.
D	Disk space is insufficient.	The disk in which the data is stored has no free space. Create more free space and try again.
T	This Symbol Name is already in use. Please choose another name.	A symbol of the same name has already been defined. Rename the symbol.
	This is not a symbol file. Please choose the correct format file.	The chosen file is not a file that can be used for symbol import. Please choose a file that is this format, or modify the chosen file so that it becomes this format.
	This is not a device comment file. Please choose the correct format file.	The chosen file is not a device comment import file. Please choose a file that is this format, or modify the chosen file so that it becomes this format.
	This symbol name is already registered as a GLC symbol. Please choose another name.	You attempted to change an existing symbol name. Designate a symbol other than one set up as GLC Discrete with the Bit Symbol and other than one set up as GLC Integer Symbol/GLC Real Symbol with the Word Symbol.
	The total number of GLC symbols is over 2048 and a Save cannot be performed. Please delete all unneeded symbols.	The maximum number of symbols has been exceeded. After deleting unneeded symbols, please retry saving the data.
S	Some data is incorrect and all data cannot be imported.	The format of CSV data to be imported is incorrect. Data in and below the line with the incorrect data will not be imported. Check Alarm data' CSV format.
	Symbol **** 's number of characters is over 20, and cannot be imported.	You attempted to import a symbol with a name over 20 characters long. Please reduce this name to less than 20 characters.
%	%s cannot be found, or cannot be performed.	The file(s) required to perform this action cannot be found. Please re-install the application software.

■ Screen Transfer Errors

	Error Message	Cause/Solution
A	A different Extended Program is present in the GP. The GP's setup cannot be performed.	This extended program can only be sent to a GP containing the same program. Please change the GP type, or install the extended task's program in the GP.
	A different Extended Program is present in the GP. Do you wish to continue?	A different type of Extended Program is present in the GP. Press OK to overwrite this program, or Cancel to stop the transfer. Selecting OK will change the GP's internal Extended Program.
C	Cannot transmit data at 115.2Kbps - used a slower speed. Change Data Transfer Speed to 38400 when sending data.	This error occurs when the speed of 115.2Kbps cannot be used, or when data is sent to a GP 70 series model at this speed. Change the Data Transfer Speed setting to 38400 and re-try.

■ **Screen Transfer Errors (from previous page)**

	Error Message	Cause/Solution
A	After selecting screens to be transferred upload information on the GP will not be correct. Continue with the transfer?	Sending screens individually can destroy the Image Control Table, and the screens may not operate correctly on the GP. If a problem occurs, resend all the screens, or use the automatic screen update feature.
C	CF Card data will not be sent to GP	Either the GP Multi Unit's power is turned OFF, or the CF Card is not formatted. Also, if the CF Card's amount of remaining space may be insufficient. Please delete all unneeded files and retry transfer.
	Command Parameter ERROR	Retry data transfer to the designated GP using "Auto Setup". If this message appears again, the PC has a command-related problem. Or, there may be an error in the cable or in the PC. Check both and retry data transfer. If the problem persists, the cable may be damaged. If necessary, contact your local GP distributor.
	Connected Device is not correct GP!	A device other than the GP or one that is not supported by GP-PRO/PB III is connected. Check the model of the connected device.
	Core - ID Command failed	An error has occurred during data transfer from the PC. The cable may be disconnected or the GP is OFF. Retry data transfer.
D	Data Transfer Port initialization error.	Initialization of the communication port has failed. Check the transfer serial port settings and transfer cable connection.
	Do you want to download the simulation protocol?	When you want to transfer the simulation protocol, click OK. Otherwise, click cancel.
E	ERROR, Out of Memory	The GP's internal memory is full. Delete any unnecessary screens.
	ERROR, Incomplete Transmission	Screen transfer to the GP has been aborted. Refer to the error message code.
	ERROR, No Configuration File	The file required for setup was not found in the specified folder. Re-install the system from the Master disk, or check the transfer path settings. (Transfer Settings area)
	ERROR, Cannot Transfer Data	A communication error has occurred and transfer has failed. Reset the GP and PC and retry data transfer.
	ERROR, Cannot open Screen	The system is trying to transfer the screen to the GP but cannot open the Project File.
G	GP node search has failed!	An error has occurred during search for the GP. Check the PC's network settings and the network cable connection. If the problem persists, contact your network manager.
H	Handshaking ERROR – GP not Responding	The GP power supply is turned OFF, the data cable is unplugged, or the GP may be in OFFLINE mode. Check all these points. When the GP main unit is in OFFLINE mode, reset it to transfer mode. Also, check the serial port.
I	Invalid address substituted for unknown aliases, or invalid address error	When using a symbol in the device address, use the symbol editor to enter the actual symbol addresses.

■ Screen Transfer Errors (from previous page)

	Error Message	Cause/Solution
M	Memory Loader Error – Unknown Type	A undefined error code has been sent from Memory Loader. Check the connection to Memory Loader. Reset Memory Loader once and then re-try data transfer.
	Memory Loader Error – Memory Loader Not Ready	The cable used for data transfer is not connected to Memory Loader, or Memory Loader is not in the PC reception mode. Check that the PC is connected to Memory Loader using the cable and set Memory Loader in the PC reception mode. Then, re-try data transfer.
	Memory Loader Error – Card Not Found	Memory Loader does not have a memory card. Insert the memory card into Memory Loader and then send the card data.
	Memory Loader Error – Timeout	Communication timeout occurs. Reset Memory Loader and re-try data transfer.
	Memory Loader Error – Memory Overflow	The transferred screen data causes an overflow of the memory capacity of Memory Loader. Delete the screen data or set the upload information transfer setting to OFF. Then, re-try data transfer.
	Memory Loader Error – Check Sum Error	A checksum error occurs during transfer. Check that the cable is properly connected and remove the noise source near the cable. Then, re-try data transfer.
	Memory Loader Error – Bad Command	The transfer command is not sent correctly. Check that the cable is properly connected and remove the noise source near the cable. Then, re-try data transfer.
	Memory Loader Error – Incorrect Data Received	The correct command is not received from the Memory Loader during transfer. Check that the cable is properly connected and remove any noise sources near the cable. Then, re-try data transfer.
	Multiple GPs have been designated as the destination, however, the system screen data will not be sent. Is this OK?	You attempted to send data to multiple GPs “Send System Screen” set to ON. When sending data to multiple GPs, the GP system settings will not be transferred. Select Yes, which means only the screen data will be transferred. To send the GP system settings, you must first match the IP address in the GP system settings with the destination GP and re-try data transfer, unit by unit.
	Memory Not Initialized	The GP internal memory is not initialized. Initialize the memory.

■ **Screen Transfer Errors (from previous page)**

	Error Message	Cause/Solution
N	Network Data Search Please enter the IP address(using standard dot separators) & IP Port Number of the GP you are connecting to. If no address is entered, the program will search in the PC's same group for this data.	Specify the GP IP address (net ID) when searching the network again or when the GP network group is different from the PC. Specify the GP IP address to be searched in the format using a dot as the delimiter. Example) 192.168.1.101
	Network Connection Failed	Connection to the specified party node is failed. Check the PC network settings and the network cable connection. If the problem still remains, contact the network manager.
	No Upload Information in GP Data File	Because the GP does not have the data required for sending the data to the PC, the PC cannot receive the screen. The screen originally may have been sent with the upload information set to "Not transfer". A screen that is not sent together with the upload information cannot be received.
P	PGO command failed PLD command failed	The power supply to the GP may have been turned OFF, or the cable has been un-plugged. Reset the GP and the PC and retry data transfer.
	Protocol file not found	The PLC protocol file to be sent to the GP is not found in the system's directory. Re-install the GP's system starting from the master disk.
S	Send SIO Error - Unable To Open a Com Port	The COM port cannot be used. In the transfer setting menu's serial port setting, specify the available serial port, and retry data transfer.
	Send File Error - Bad File Data	The data to be sent is not correct. The data created in the temporary file cannot be read correctly. Check that the disk has sufficient free space and it is not corrupt, and retry file transfer.
	Simulation data file cannot be found.	The CSV file is not stored in the directory as the execution file. The simulation information file may be deleted, or the file may have not been created. Set the simulation feature when transferring the screen and retry data transfer.
	Simulation data file read-in error.	The CSV file cannot be read into the system. The simulation information file may have been deleted, or the file may have not been created. Set the simulation feature when transferring the screen and retry data transfer.
T	TCP/IP error	The PC's TCP/IP setting is not correct; or, the TCP/IP data is not registered. Check that the correct TCP/IP are registered in the PC's control panel, and that all control panel setting values, including the IP address, are correct.
	The IP Address of the system screen being sent and that in the GP are not the same. To send all screens, press "Yes". ("No" to send only screen data) However, if "2-Way Driver" has been designated as the destination, sending the GP's System Setting data will not change (overwrite) the IP address.	The IP address currently being sent is different from the address designated in the GP's system settings. To change the IP address, click on "Yes", to preserve the IP address, click on "No". You can either send the screen data or select "Cancel", and then change the current project data's IP address so that it matches that of the GP's.

■ **Screen Transfer Errors (from previous page)**

	Error Message	Cause/Solution
T	The Extended Program cannot be found.	The Extended Program required for setting up the GP cannot be found. Please check the CFG file's directory. Also, you may need to change the GP's type.
	The Extended Program cannot be found in the GP. The GP's Setup cannot be performed.	Unable to locate the program's destination GP for setup. Check the GP type settings and the GP type selected. Change the GP type, if needed.
	The currently selected Device/PLC type does not support the Simulation feature.	The currently selected Device/PLC type does not support the Simulation feature. This feature cannot be used with the destination Device/PLC. Deselect this feature and re-send the data.
	This GP does not support Extended Programs. The GP's setup cannot be performed.	The destination GP does not support Extended Features. Either change the GP Type, or send data that is designed for the designated GP type.
	Timeout Error	Communication timeout has occurred. Reset the GP and re-try data transfer.
W	Winsock return Error	An error has been returned from Winsock. The error is in the network line. Check the PC's network settings and the network cable connection. If the problem still remains, contact your network manager.
	Write Error	An error has occurred while reading the data to GP internal memory. Re-try data transfer. If the error occurs again, use the GP's self-diagnosis feature and identify the problem. If necessary, contact your local GP distributor.

■ **File Converter Errors**

	Error Message	Cause/Solution
C	Cannot read system information	An error is recognized in the SCD file. Check that the SCD file is created by Parts Box Version 2.0.
	Conversion aborted - database space insufficient!	The disk space is not sufficient to perform data conversion. Reserve sufficient free space and retry file conversion.
	Conversion destination (convert to) folder is not designated.	The conversion destination folder where the converted file will be stored is not specified. Specify it.
	Conversion parameters are not set	The conversion parameters for the information to be converted (conversion source, conversion destination file information) are not set. Set the required information.
I	Insufficient memory	The memory required for file conversion is insufficient. Quit all other applications, then retry file conversion.
	Invalid PLC table	The PLC table file is not a GP file, is corrupt for some reason, or has been deleted. Re-install the Device/PLC type master data file from the master disk.

■ File Converter Errors (from previous page)

	Error Message	Cause/Solution
O	Old CPL files from DOS version PROPB must be selected directly from the library browser's file type menu	The specified CPL file has been created by the GP-PRO/PB III DOS version. Select the file from the file selection menu of the screen editor's library browser.
	Old PLC table and some functions may not work properly. Please use latest PLC table	An old version of the PLC table file is installed. Re-install the new version of the Device/PLC type file from the master disk.
P	PLC file error	The PLC table file is not the type used for GP files, is corrupt for some reason, and has been deleted. Re-install the Device/PLC type master file from the master disk.
	PLC file not found	The specified PLC table file could not be found in the directory, or it is not the type used for a GP file. Re-install the Device/PLC type master file from the master disk.

■ Project Compression and Execution Errors

	Error Message	Cause/Solution
D	Disk Error - File Error During Read	The file cannot be opened. The most probable cause is corruption of the file or disk failure. Solve the problem and try again to read the file.
	Disk Error - File Error During Write	The disk is write-protected. Take off the write protection. This error also occurs when the disk is defective.
U	Unable to open file '****'. Would you like to try to find it elsewhere?	A portion of the file cannot be found. To recover divided files and recreate the original project file, all the divided files are required.
	Unable to open file '****' for reading, aborting...	The file cannot be opened. The file is corrupt or the disk has a problem. After correcting the problem, re-try opening the file.

* The file named is inserted here ***.

■ Rebuild Tool Errors

	Error Message	Cause/Solution
F	File version does not match	The specified file contains settings for a version which is not supported by this rebuilding tool. Re-specify a project file (PRW file) compatible with GP-PRO/PB III for Windows.
R	Rebuilding the File has Failed	Recovery of the file has failed. This file is damaged and cannot be rebuilt.
S	PRW header is destroyed	The file header information is corrupt. This file cannot be rebuilt and cannot be used.

■ **DXF File Conversion Errors**

The error messages generated during DXF file conversion are as follows:

(xynn) <message> (line = ????)

x : Conversion direction (1: DXF → GP / 2: GP → DXF)

y : Procedure (1: Read 2: Conversion 3: Write)

nn : Error code

(line = ????) : Line No. of the DXF file causing the error

■ **DXF File Conversion Errors**

Error Code	Error Message	Cause/Solution
01	Length Over in 1 record (line, ????)	The single record length of the DXF file exceeds 256 characters. Edit the error line so that the length is less than 256 characters.
02	DXF Format Error (line, ????)	Non-DXF data may be included. Correct the format of the data at the error line.
03	HEADER SECTION Not Found	The header section of the DXF file to be read is not found. Add the header section.
04	\$LIMMIN Not Found	The header section of the DXF file to be read does not have a \$LIMMIN setting. Set the option DXF size to "Use \$EXTMIN, \$EXTMAX" and re-execute the program, or add the \$LIMMIN setting.
05	\$LIMMAX Not Found	The header section of the DXF file to be read does not have a \$LIMMAX setting. Set the option DXF size to "Use \$EXTMIN, \$EXTMAX" and re-execute the program, or add the \$LIMMAX setting.
06	\$EXTMIN Not Found	The header section of the DXF file to be read does not have a \$EXTMIN setting. Set the option DXF size to "Use \$LIMMIN, \$LIMMAX" and re-execute the program, or add the \$EXTMIN setting.
07	\$EXTMAX Not Found	The header section of the DXF file to be read does not have a \$EXTMAX setting. Set the option DXF size to "Use \$LIMMIN, \$LIMMAX" and re-execute the program, or add the \$EXTMAX setting.
08	EOF Not Found	The EOF record is not specified at the end of the DXF file to be read. Add the EOF record.
0A	ENDSEC Not Found	The ENDSEC record is not specified at the end of the DXF file to be read. Add the ENDSEC record.
0B	ENDTAB Not Found (line, ????)	The ENDTAB record is not specified at the end of the TABLE section of the DXF file to be read. Add the ENDTAB record.
0C	(W) SEQEND Not Found (line, ????)	SEQEND to be used as a pair with VERTEX following the POLYLINE entity is not specified. Add the SEQEND record to the error line.
0D	Insufficient Data (line, ????)	The essential data for the element of each entity is insufficient. Add the required data to the error line.

■ DXF File Conversion Errors(from previous page)

Error Code	Error Message	Cause/Solution
0E	LTYPE Not Defined (line, ????)	The line type name specified when the entity line type is individually set is not defined in the TABLE section. Add the data of the preset line name to the TABLE section.
0F	LAYER Not Defined (line, ????)	The layer name set in the entity is not defined in the TABLE section. Add the preset layer name to the TABLE section.
10	STYLE Not Defined (line, ????)	The character style name used in the entity is not defined in the TABLE section. Add the character style name to be used to the TABLE section.
11	BLOCKS Not Defined (line, ????)	The composite picture name which is referenced by the INSERT and DIMENSION entities is not defined in the BLOCK section. Add the data of the preset composite picture name to the BLOCK section.
21	Application Error	An unexpected data case is found in the intermediate file. (This does not occur normally.) The temporary file created during conversion may not have been written. Check the free disk space and disk condition and retry conversion.
22	BLOCKS Not Found	The specified composite picture is not found when converting the INSERT and DIMENSION entities. Add the preset composite picture data to the BLOCK section.
23	(W) BLOCKS - Over Nesting Limit	The reference layers of the composite picture are more than 10 layers. A compound graphic with more than 10 layers cannot be converted. Correct the graphic data so that the number of layers will be 10 or less.
24	(W) Conversion Data is Over 16 Kbytes	The output GP screen size (after conversion) exceeds 16 K bytes. The subsequent data cannot be converted.
41	Format Error	The format of the GP data is not correct. GP data which is not supported may be involved, or the screen data is corrupt. Use the Editor to save the screen again and retry conversion.
42	(W) Check Sum Error	The checksum of the GP screen read is not correct. The data may be corrupt. Use the Editor to save the screen again and retry conversion.
43	(W) Library Screen Not Found ????	The screen being called is not found in the project. Create a destination screen or delete the data which calls the screen.
44	(W) Mark Screen Not Found ????	The mark screen being called is not found in the project. Create the destination mark screen or delete the data which calls the mark.

■ DXF File Conversion Errors(from previous page)

Error Code	Error Message	Cause/Solution
45	(W) Library Screen Type Error (0x????)	The type of the screen used in the screen call menu is not a base, mark, trend graph, keypad, or an image screen. GP data which is not supported may be involved, or the screen data may be corrupt. Use the Editor to save the screen again and retry conversion.
46	(W) Screens – Over Nesting Limit	The screen calling layers are greater than 10. Screens with more than 10 layers cannot be converted. Correct the data so that the number of layers will be 10 screens or less.
81	Disk Full	When writing the temporary file or output file, the disk has become full. Increase the amount of free disk space for the temporary file and output file.
82	Insufficient Memory	The process is interrupted because of insufficient memory area during operation. Close all other applications and retry the operation.
FF	User Abort	The user has interrupted the operation during conversion.

■ File Management Errors

	Error Message	Cause/Solution
C	Cannot Write File ????	The data cannot be written to the specified output file name. Check the amount of free disk, or if the disk is write-protected.
I	Input File Name Format Error	The specified input file name is different from the file name created by the editor. Specify the correct file name.
	Input File Not Found	The specified input file is not found. Check the file name and specify the existing file.
O	Output File Name Format Error	The specified output file name cannot be recognized by the editor. Specify the correct file name.
W	Work Directory Not Found ????	The folder in which the temporary file is created is not found. Specify the existing folder using the environment variable TEMP.

■ Simulation Errors

	Error Message	Cause/Solution
A	Abnormal CF card in GP Slot.	Check that the CF Card is the correct type for the GP. If it is, retry.
C	Cannot read data in project file.	The screen data cannot be read from the project file. Quit other functions and re-execute.
	Cannot write simulation information data. Unable to start simulation.	The system cannot write the data to the simulation information file. Check that the simulation file (TAGDATA.CSV) is not used in other applications and that the directory in which EXE exists is not write-protected.
	CF card in GP Slot has file [CAPTURE¥¥CP65535.JPG] already. GP cannot generate more filename and snapshot file. ¥n¥n Please make rearrange files in CF card.	Delete the CF Card's "CAPTURE/CP65535.JPG" file, reorganize the CF Card's files, and retry.
G	GP cannot find CF card.	Check that the CF Card is securely inserted into the CF Card Slot.
	GP cannot write snapshot to CF card.	Check that the amount of free space on the CF Card is sufficient, and if it is, retry.
N	Not enough memory. Please close other applications.	Retry this action after closing other active applications.
P	PLC Data File cannot be found.	The PLC table file does not exist in the specified directory. The PLC table file is deleted or it is not for the GP. Select the Device/PLC type file from the master disk and reinstall the file.
S	Simulation aborted by link down. ¥n Please restart GP hardware.	A problem such as a cable disconnection, etc. has caused the PC and the GP to not be able to communicate, which has led to the halting of the Simulation. To restart the Simulation feature, first manually reset the GP (including checking the power cord), and confirming that the Data Transfer cable is securely connected to both the PC and the GP. Next, restart the Simulation.
	Simulation start failed.	The GP does not respond to the simulation start command. The GP may be in another mode, or data transfer may have failed. Check the communication port settings, cable connections, GP unit power supply, and then retry the simulation data transfer.
	Simulation data file cannot be found.	The simulation information file (TAGDATA.CSV) does not exist in the specified directory. Check (turn on) the Transfer menu [Settings] area's [Simulation] selection, then retry the Simulation.
	Simulation link goes down. Do you want to abort simulation?	If you wish to continue the Simulation, check that the Data Transfer cable is securely connected, and click [No]. Normally, after a brief pause the Simulation will be restored. However, timing and other problems can prevent restoration, and will cause this message to reappear. In that case, click on [No] and quit the simulation.
	Snapshot incomplete.	Check that the GP's Data Transfer cable is securely connected and retry.

Appendices

■ Sound Setting Errors

(**** means the User's designated file name will be inserted here.)

	Error Message	Cause/Solution
C	Cannot access **** file.	File access has failed and the file cannot be accessed.
	Cannot access the drive. Device preparation is not possible.	Failed to access the drive. Check if an error occurred in any disk during file access.
	Cannot create **** file. Write error.	File writing has failed. Please check that the disk is correctly inserted and not write protected.
	Cannot designate CF Card Output Folder. Please designate folder.	Please designate the CF Card data's output folder.
	Cannot find **** file.	The designated file cannot be found.
	Cannot load the Share.exe program.	This program is currently being used by another program. When more than one application will be using this program, be sure to install it in your software's application folder.
	Cannot open **** file.	The designated file cannot be opened.
	Cannot see sound data.	Data conversion was performed after the CF Card's designated sound file was deleted.
	Cannot set address. Invalid address.	Designated address setting will cause continuously set addresses to exceed allowed range.

■ Sound Setting Errors(from previous page)

	Error Message	Cause/Solution
D	Deleted Folder while creating **** file.	The folder was deleted during data write.
	Drive disk is full. Data write failed.	Failed to write data to the disk. Check the disk capacity.
E	Error in Device Address	An unrecognized device address has been specified. Please check that the address is correct.
F	**** file is locked. Access is not possible.	The file cannot be accessed. Check if the file is being used by any other application(s).
	**** file is destroyed.	The file is destroyed (unreadable). Check on the condition of the file's disk.
	**** file format error.	The file is destroyed (unreadable). Check on the condition of the file's disk.
L	Limit for sound data! /nNot all will be merged.	Registered number of sound files to be merged exceeds limit.
P	Protected **** file. Cannot be accessed.	Check if the file is read-only, or if the disk is locked.
S	Seek error occurred during **** file access.	An error has occurred during file access. Check the condition of the file's disk.
T	The currently operation exceeds the GP's internal memory limit. Paste cannot be performed.	Reduce the amount of data copied.
	This type of WAV file format is not supported. Only PCM, 11KHz, 16 bit, and Mono type data can be read.	Change the data's format to PCM, 11KHz, 16 bit, and Mono.
	This data already exists. Do you wish to overwrite?	Sound data already exists in the designated sound data save destination.
W	WAV file is too large. All data cannot be converted. Is partial conversion OK?	The file is too large and all cannot be converted to a GP file. If possible, reduce the file's size.
T	The currently operation exceeds the GP's internal memory limit. Paste cannot be performed.	The desired Paste operation's data is too large for the GP's memory. Reduce the amount of data to be copied.
	This type of WAV file format is not supported. Only PCM, 11KHz, 16 bit, and Mono type data can be read.	Change the data's format to PCM, 11KHz, 16 bit, and Mono.
	This data already exists. Do you wish to overwrite?	Sound data already exists in the designated sound data save destination.
W	WAV file is too large. All data cannot be converted. Is partial conversion OK?	The file is too large and all WAV data cannot be converted to a GP file. If possible, reduce the file's size.

■ Logging Data Errors

	Error Message	Cause/Solution
A	Address Entry limit reached. No more addresses can be entered.	Reduce the number of device addresses used.
C	Character size is too large. Please use a different size.	Designated character is larger than GP's character matrix. Please select a smaller size.
D	Display file data size is over maximum.	Reduce the size of the designated display.
M	Maximum number of lines is 40.	Be sure the number selected is 40 or less.

■ **Logging Data Errors**(from previous page)

	Error Message	Cause/Solution
P	Paste failed.	The current paste settings (range, etc.) are not the same as the paste destination. Or, the paste action may delete a column or effect another data item's settings.
	Printer file data size is over.	Reduce the size of the area/amount of data to be printed.
T	Time settings cannot exceed 24 hours. Please adjust the settings.	Change the settings so that the time value is 24 hours or less.
	The no. of times x no. of blocks should be less than or equal to 2048.	Be sure the number of times and number of blocks produces a result that is 2048 or less.

■ **Filing Data Errors**

	Error Message	Cause/Solution
C	Cannot import CSV file. Data is out of range or format is incorrect.	The number of blocks or data amounts is inappropriate in the CSV file to be imported. Enter the correct value(s).
D	Data is larger than designated data range. Please check the data settings.	Data from outside the Filing Data's range is present. Check the designated data range settings and change them if necessary.
E	Exceeds folder addition limit.	Up to 64 folders can be stored in the internal memory and up to 8999 folders can be stored in the CF card. Any folder cannot be added because the number of folders will exceed the limit.
F	File cannot be accessed and data cannot be saved. Please check the CF Card's output folder.	Check if the CF Card is write-protected. Either remove the write protection or change the destination folder.
I	Internal memory is not sufficient to save data. Please reduce the block or data settings.	The current settings will overflow the GP's memory. Please reduce either the block or data settings.
P	Please enter a Block name.	Nothing has been entered for the Filing Data's Block data. Please enter a name.
T	The currently selected data range exceeds the maximum amount allowed. Paste cannot be performed.	Please reduce either the amount of data copied or the number of blocks copied.
W	When using 32 bit data settings the maximum number of data items is 20. OK to delete items over 20?	When using 16 bit data, up to 40 items can be used; with 32 bits, maximum is 20. Be sure the data type fits your data needs.

■ **CF Card Tool Errors**

	Error Message	Cause/Solution
C	Copy has failed.	Please check the disk for any problems.

■ **2-Way Driver Setting Errors**

	Error Message	Cause/Solution
D	Data could not be created.	An error occurred while 2-Way Driver data was being created. Check the volume available of the disk being used. Also, check if the project file exists or not.
	Data could not be saved.	An error occurred while 2-Way Driver data was being saved. Check both disk memory and if the project file exists or not.

A.2 Troubleshooting

This section describes how to solve problems generated when using GP-PRO/PB III.

Before you begin troubleshooting, please check the following items again. If you answer “Yes” to all the questions, start troubleshooting. If you answer “No” to any one of the questions, set the required item and then start troubleshooting.

If the error still occurs after troubleshooting, fill the details on the error in the provided trouble report sheet and contact DIGITAL.

Item	Check
Is your personal computer's OS Windows 95/ 98/ Me/ NT/ 2000	
Is the memory capacity greater than 32 Mbytes?	
Is your PC hard disk's amount of free space sufficient?	

A.2.1 Troubleshooting List

Error	Cause/Solution
GP-PRO/PB III will not start up	Are all the environment settings correct?  CD Jacket
	Is your personal computer hard disk's free space amount sufficient? Double-click on the Windows icon. Double-click on the drive in which GP-PRO/PB III has been installed. Use the [File] menu's [Property] feature to check the amount of free disk space. If the free disk space is insufficient, empty the trash box or delete unnecessary files from the hard disk.
	Is the PC's RAM memory capacity sufficient? Memory of 16 M byte or more is required. Click the Windows [Start] button first, and then click on the [Settings], [Control Panel], and [System] selections. Click the virtual memory button in the system property dialog box and check that "Auto Setting (recommended)" is selected. If "Manual Setting" is selected, change the setting to "Auto Setting (recommended)". Restart the PC and then restart GP-PRO/PB III.
	Some applications do not work well with GP-PRO/PB III and such an application may interfere with the startup of GP-PRO/PB III. Quit all running applications and delete them from the Startup menu ([Startup] in the Windows [Program] menu. Restart the PC and then restart GP-PRO/PB III.

Error	Cause/Solution
Cannot draw graphic data	<p><u>Is the Editor's screen open?</u> With GP-PRO/PB III, you must select the project file and open a drawing screen before you can draw any objects. Create a new a screen or open an existing one.</p>
	<p><u>Does the disk have enough free space?</u> Prepare a disk which has enough free space.</p>
	<p><u>Is the symbol editor started?</u> The screen editor and the symbol editor cannot be started at the same time. Check that the symbol editor window has been closed.</p>
Cannot save the screen file's data	<p><u>Is the file write-protected?</u> Check whether the floppy disk is write-protected using the [Property] feature.</p>
	<p><u>Does the disk you are saving to have enough free space?</u> Prepare a disk which has enough free space.</p>
Cannot communicate between the PC and the GP	<p><u>Is the proper cable being used?</u> Be sure to use the DIGITAL transfer cable (option).</p>
	<p><u>Is the GP in the "Screen Data Transfer Mode" or "Run Mode"?</u> If not, communications between the PC and the GP will not be possible. ▼Reference▼ GP User Manual</p>
	<p><u>When receiving data from the GP, does your PC's hard disk have enough space?</u> Prepare the disk so that it has enough free space.</p>
	<p><u>Is the communication port setting correct?</u> Check that the transfer cable's serial port matches the port set in [Transfer].</p>
	<p><u>Does another application use the same communication port?</u> Check whether there is competition between the GP and a modem, or other applications which require the communication port.</p>
	If: the Buzzer won't stop. The GP wont display data. Data transfer fails.
The printer does not run/ hard copy is not printed correctly	<p><u>Is the OS's (Windows) printer setting correct?</u> Check the printer setting using the Control Panel's printer property.</p>
The desired Device/PLC type and GP type are not listed when creating a new project	<p><u>Did you select the required Device/PLC and GP types when installing GP-PRO/PB III? (Custom Installation)</u> When customizing the system installation, you can select the PLC and the GP types. You cannot install a Device/PLC type or a GP type if it has not been selected previously. Re-install the system with the desired PLC and GP types.</p>
Simulation cannot be performed	<p>Possible causes are that LS area data is being backed up to the GP, via the [GP System Settings], or that an LS area Special Relay is being used via D-Script or by a W-tag start up bit. If any of these are true, the simulation cannot be performed. Deselect the [Option] menu - [Settings] - [LS Device Simulation].</p>
The GP2000 series cannot be booted. Nothing is displayed on the screen and a buzzer intermittently sounds	<p>The GP was not successfully set up. For details, refer to "Buzzer will not Stop/No Display on the GP/Transfer Disabled".</p>

A.2.2 Buzzer will not Stop/No Display on the GP/Transfer Disabled

■ Error Pattern by Symptom

Error Pattern	Applicable Model	Buzzer Sound (Symptom)	GP Screen	Probable Cause
1	All models	Pip, pip, pip, ... (Continues to beep intermittently or beeps every second.)	Blank (Black)	There is no startup program or the startup program has been corrupted.(When the GP is powered on)
2	All models	None	Normal Display	Transfer cable was removed. Improper COM port was used.
3	GP2000 Series	Pip, pip. ... (Continues to beep intermittently twice every other second.)	Blank (Black)	The system for the target model has not been downloaded. (When the GP is powered on)
4	GP70/77R Series	None		
5	GP2000 Series	None	Error Message	System is not set up properly. The following warning message is displayed: "No system installed. Perform Screen Transfer (Force System Setup)".
6	All models	None	Blank/Normal	Invalid access is made to "+9" or "+14" of the System Data Area.
		Buzzer sounds continuously		

Refer to Solution 1 when error pattern 1 is observed.

Similarly, Solution 2 corresponds to Error Pattern 2.

When error pattern 3, 4 or 5 is observed, try the procedure described in Solution 3. If Solution 1 or 2 does not solve the problem with error patterns 1 and 2, try Solution 3 as well.

The solution with the CF Memory Loader Tool is also available with the GP2000 series. Refer to the relevant section.

◆ Solution 1

1. Transfer from the PC

Transfer programs and screen data from the PC (GP-PRO/PBIII for Windows) to the GP while the buzzer of the GP sounds. (Be sure that your PC and the transfer cable are able to transfer programs and data to the GP.) GP-PRO/PB for Windows has been programed to handle a variety of problems and retry data transfer repeatedly if the GP fails to respond successfully. In this case, GP-PRO/PB for Windows will try repeatedly to complete handshake mode (it may take more than a minute in some situations). After handshaking is completed, GP-PRO/PB for Windows will begin to transfer the Memory Loader program, system program, communication protocol program, expansion program and screen data.

◆ **Solution 2**

The transfer cable is improperly connected or has been removed. The improper COM port may have been selected. Confirm that the cable and port are set up properly for data transfer and try again.

◆ **Solution 3**

If error pattern 3, 4 or 5 has been observed, or Solution 1 or 2 does not solve the problem, perform a forced transfer from your PC. Perform the transfer even if the buzzer is sounding. (Confirm that the cable and PC are configured for successful transfers.)

1. Select [Setup] from the [Setup] menu on the [Screen Transfer] to display the [Transfer Settings] dialog box on the screen.
2. Select "Force System Setup" from the "Setup" field and click the [OK] button.

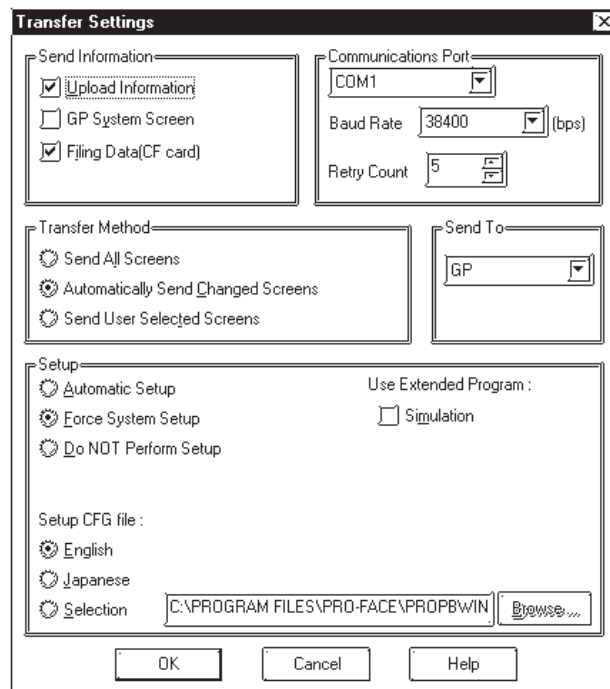

3. Select [Screen Transfer] from the [Transfer] menu and perform a forced transfer.
4. When the message "No System Program on the GP" is displayed on the screen, click the [OK] button.
This message will not be displayed if the protocol has not been downloaded to the GP.

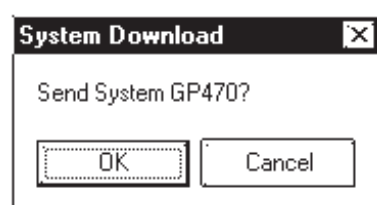

5. The message "Select GP Type" is displayed on the screen. Select the model type and click the [OK] button.

Usually, the system automatically selects the connected model. However, confirm the model type of the connected GP.

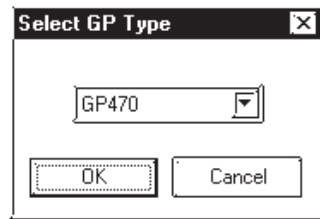

If an improper model type is selected here before a forced transfer, the symptoms will recur.

6. Check the GP type and click the [OK] button. The system begins transferring the System Program, Protocol Program and screen data. The restoration is completed when the transfer is completed successfully. In some cases, the "handshaking" (transfer to the GP unit) with the GP may not be successful.

If handshaking is unsuccessful, the system displays the following message on the screen to ensure successful handshaking with the GP.

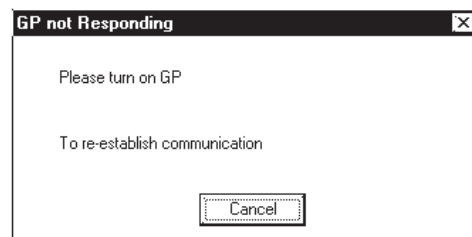

Power the GP OFF and ON again. The system will automatically resume the transfer.

◆ Solution 4

Check whether an incorrect value has been entered into the GP in "+9" or "+14" of the System Data Area, or an invalid Start Address has been assigned for the System Data Area.

◆ CF Memory Loader Operation (GP2000 series only)

Insert the CF Card containing the CF Memory Loader programs* into the GP and set the DIP SW No.1 located next to the CF Card slot to ON (see figure below). Then turn ON the GP's power supply. The CF Memory Loader will then automatically start.

*IPL. SYS, MLD****. SYS, BK****. MEM; where **** represents the model code of the target GP.

Reference [10.5.5 Creating Backup Data](#), [10.5.6 Sending Backup Data](#)

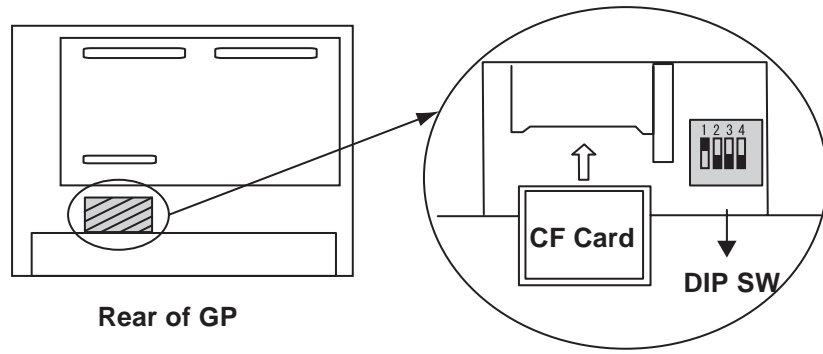

Use the CF Memory Loader Tool to download the data to the GP.

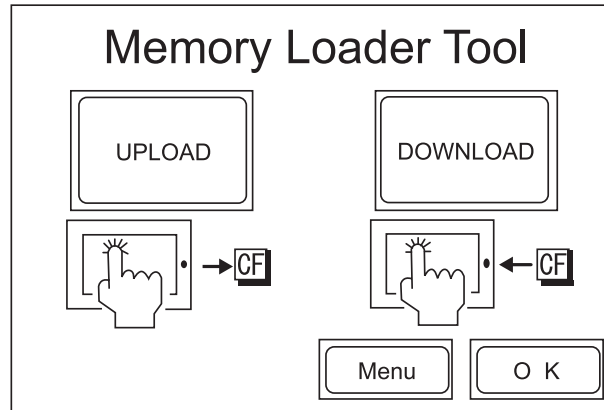

After data download is finished, remove the CF Card, set DIP SW No.1 to OFF and restart your GP.

The buzzer may sound as described below when a problem is handled with the CF Memory Loader Tool.

Error Pattern	Applicable Model	Buzzer Sound (Symptom)	Probable Cause
1	GP2000 Serie	Pip, pip, pip. ... (Continues to beep intermittently three times every other second.)	MLD****. SYS of the CF memory loader does not exist or has been corrupted. (This symptom may occur when the GP is powered on by switching on switch No.1 of the DIP SW near the CF card slot or the CF startup is performed through the 3-point pressing menu.)
2	GP2000 Serie	Pip, pip, pip, pip. ... (Continues to beep intermittently four times every other second.)	IPL. SYS of the CF memory loader exists but has been corrupted. (This symptom may occur only if the CF startup is performed through the 3-point pressing menu.)

◆ **Solution of Error Pattern 1**

If there is no “MLD****. SYS” for the target GP present in the CF Card, copy or transfer it from your PC.

If the file “MLD****. SYS” is present in the CF Card and the problem still occurs, reformat the CF Card and resend both this file and “IPL. SYS” or “MLD****. SYS,” to the CF Card.

◆ **Solution of Error Pattern 2**

Reformat the CF Card and then send the necessary files, including “IPL. SYS” or “MLD****. SYS” to the CF Card.

A.3**Address Conversion Tables**

Addresses can or cannot be converted depending on the address combination. The combinations which cannot be converted vary with the external device manufacturers. See the following address global conversion table to convert the addresses correctly.

■ How to Read the table

The symbols used in the table have the following meanings:

- : When the address conversion device type is set to [Word], the system converts both Word and bit devices. When the [Bit] setting is used, only bit device addresses are changed.
- ◆ : When the selected conversion mode is [Word], only Word addresses are converted. Selecting [Bit] will convert only bit addresses.
- ★ : When [Word] mode is selected, the system converts only word addresses.
- : When [Bit] mode is selected, the system converts only bit addresses.

(Blanks cannot be converted)

For the timers and counters, the bit indicates the contact or coil used, and the word indicates the current value (elapsed value) or setting value

■ Address Conversion Table List

Memory link SIO Type

Memory Link Ethernet Type

CC-Link (Remote Device Unit)

Device Net Slave I/O

		After conversion
		LS
Before conversion	LS System Area	○

■ Mitsubishi Electric MELSEC-A

		After Conversion											
		X	Y	M	L	F	B	TS/TC/TN	CS/CC/CN	D	W	R	LS
Before Conversion	X Input Relay	○	○	○	○	○	■	◆	◆	○	○	○	○
	Y Output Relay	○	○	○	○	○	■	◆	◆	○	○	○	○
	M Internal Relay, Special Relay	○	○	○	○	○	■	◆	◆	○	○	○	○
	L Latch Relay	○	○	○	○	○	■	■	■	○	○	○	○
	F Annunciator	○	○	○	○	○	■	◆	◆	○	○	○	○
	B Link Relay	■	■	■	■	■	■	■	■	■	■	■	■
	TS/TC/TN Timer	◆	◆	◆	◆	◆	◆))	◆	◆	◆	◆
	CS/CC/CN Counter	◆	◆	◆	◆	◆	◆))	◆	◆	◆	◆
	D Data/Special Register	○	○	○	○	○	■	◆	◆	○	○	○	○
	W Link Register	○	○	○	○	○	■	◆	◆	○	○	○	○
	R File Register	○	○	○	○	○	■	◆	◆	○	○	○	○
	LS System Area	○	○	○	○	○	■	◆	◆	○	○	○	○

■ Mitsubishi Electric MELSEC-N

		After Conversion											
		X	Y	M	L	F	B	TS/TC/TN	CS/CC/CN	D	W	R	LS
Before Conversion	X Input Relay	○	○	○	■	○	■	◆	◆	○	○	○	○
	Y Output Relay	○	○	○	■	○	■	◆	◆	○	○	○	○
	M Internal Relay, Special Relay	○	○	○	■	○	■	◆	◆	○	○	○	○
	L Latch Relay	■	■	■	■	■	■	■	■	■	■	■	■
	F Annunciator	○	○	○	■	○	■	◆	◆	○	○	○	○
	B Link Relay	■	■	■	■	■	■	■	■	■	■	■	■
	TS/TC/TN Timer	◆	◆	◆	◆	◆	■	◆	◆	◆	◆	◆	◆
	CS/CC/CN Counter	◆	◆	◆	◆	◆	■	◆	◆	◆	◆	◆	◆
	D Data/Special Register	○	○	○	■	○	■	◆	◆	○	○	○	○
	W Link Register	○	○	○	■	○	■	◆	◆	○	○	○	○
	R File Register	○	○	○	■	○	■	◆	◆	○	○	○	○
	LS System Area	○	○	○	■	○	■	◆	◆	○	○	○	○

■ Mitsubishi Electric MELSEC-F₂

		After Conversion							
		X	Y	N	S	T/TC/TS	C/CC/CS	D	LS
Before Conversion	X Input Relay	■	■	■	■	■	■	■	■
	Y Output Relay	■	■	■	■	■	■	■	■
	M Auxiliary Relay, Keep Relay	■	■	■	■	■	■	■	■
	S State	■	■	■	■	■	■	■	■
	T/TC/TS Timer	■	■	■	■	○	○	■	■
	C/CC/CS Counter	■	■	■	■	○	○	■	■
	D Data Register	■	■	■	■	◆	◆	○	○
	LS System Area	■	■	■	■	◆	◆	○	○

■ Mitsubishi Electric MELSEC-FX

		After Conversion							
		X	Y	M	S	TS/TN	CS/CN	D	LS
Before Conversion	X Input Relay	○	○	○	○	◆	◆	○	○
	Y Output Relay	○	○	○	○	◆	◆	○	○
	M Internal Relay	○	○	○	○	◆	◆	○	○
	S Step Relay	○	○	○	○	◆	◆	○	○
	TS/TN Timer	◆	◆	◆	◆	○	○	◆	◆
	CS/CN Counter	◆	◆	◆	◆	○	○	◆	◆
	D Data Register	○	○	○	○	+	+	○	○
	LS System Area	○	○	○	○	+	+	○	○

■ Mitsubishi Electric MELSEC-FX₂N

		After Conversion							
		X	Y	M	S	TS/CS	TN/CN	D	LS
Before Conversion	X Input Relay	○	○	○	○	■	★	○	○
	Y Output Relay	○	○	○	○	■	★	○	○
	M Internal Relay	○	○	○	○	■	★	○	○
	S Step Relay	○	○	○	○	■	★	○	○
	TS/CS Timer	■	■	■	■	■	★	■	■
	TN/CN Counter	★	★	★	★		★	★	★
	D Data Register	○	○	○	○	◆	★	○	○
	LS System Area	○	○	○	○	◆	★	○	○

■ Mitsubishi Electric FREQROL Series

		After Conversion			
		-	P	All devices except for parameter	LS
Before Conversion	Parameter except for FR-S500, E500's Pr-37	○	○	○	○
	P	○	○	○	○
	Parameter for FR-S500, E500's Pr-37	○	○	○	○
	All devices except for parameter	○	○	○	○
	LS System Area	○	○	○	○

■ Mitsubishi Electric MELSEC-QnA

		After Conversion																										
		X	Y	M	SM	L	F	V	S	B	SB	TS	TC	SS	SC	CS	CC	TN	SN	CN	D	SD	W	SW	R	0R 31R	LS	
Before Conversion	X Input Relay	○	○	○	○	○	○	○	○	○	■	■	■	■	■	■	★	★	★	○	○	○	○	○	○	○	○	○
	Y Output Relay	○	○	○	○	○	○	○	○	○	○	■	■	■	■	■	■	★	★	★	○	○	○	○	○	○	○	○
	M Internal Relay	○	○	○	○	○	○	○	○	○	○	■	■	■	■	■	■	★	★	★	○	○	○	○	○	○	○	○
	SM Special Relay	○	○	○	○	○	○	○	○	○	○	■	■	■	■	■	■	★	★	★	○	○	○	○	○	○	○	○
	L Latch Relay	○	○	○	○	○	○	○	○	○	○	■	■	■	■	■	■	★	★	★	○	○	○	○	○	○	○	○
	F Annunciator	○	○	○	○	○	○	○	○	○	○	■	■	■	■	■	■	★	★	★	○	○	○	○	○	○	○	○
	V Edge Relay	○	○	○	○	○	○	○	○	○	○	■	■	■	■	■	■	★	★	★	○	○	○	○	○	○	○	○
	S Step Relay	○	○	○	○	○	○	○	○	○	○	■	■	■	■	■	■	★	★	★	○	○	○	○	○	○	○	○
	B Link Relay	○	○	○	○	○	○	○	○	○	○	■	■	■	■	■	■	★	★	★	○	○	○	○	○	○	○	○
	SB Special Link Relay	○	○	○	○	○	○	○	○	○	○	■	■	■	■	■	■	★	★	★	○	○	○	○	○	○	○	○
	TS Timer (contact)	■	■	■	■	■	■	■	■	■	■	■	■	■	■	■	■				■	■	■	■	■	■	■	■
	TC Timer (coil)	■	■	■	■	■	■	■	■	■	■	■	■	■	■	■	■				■	■	■	■	■	■	■	■
	SS Aggregate Timer (contact)	■	■	■	■	■	■	■	■	■	■	■	■	■	■	■	■				■	■	■	■	■	■	■	■
	SC Aggregate Timer (coil)	■	■	■	■	■	■	■	■	■	■	■	■	■	■	■	■				■	■	■	■	■	■	■	■
	CS Counter (contact)	■	■	■	■	■	■	■	■	■	■	■	■	■	■	■	■				■	■	■	■	■	■	■	■
	CC Counter (coil)	■	■	■	■	■	■	■	■	■	■	■	■	■	■	■	■				■	■	■	■	■	■	■	■
	TN Timer (current value)	★	★	★	★	★	★	★	★	★	★							★	★	★	★	★	★	★	★	★	★	★
	SN Aggregate Timer (current value)	★	★	★	★	★	★	★	★	★	★							★	★	★	★	★	★	★	★	★	★	★
	CN Counter (current value)	★	★	★	★	★	★	★	★	★	★							★	★	★	★	★	★	★	★	★	★	★
	D Data Register	○	○	○	○	○	○	○	○	○	○	■	■	■	■	■	■	★	★	★	○	○	○	○	○	○	○	○
	SD Special Data Register	○	○	○	○	○	○	○	○	○	○	■	■	■	■	■	■	★	★	★	○	○	○	○	○	○	○	○
	W Link Data Register	○	○	○	○	○	○	○	○	○	○	■	■	■	■	■	■	★	★	★	○	○	○	○	○	○	○	○
	SW Special Link Register	○	○	○	○	○	○	○	○	○	○	■	■	■	■	■	■	★	★	★	○	○	○	○	○	○	○	○
	R File Register (normal)	○	○	○	○	○	○	○	○	○	○	■	■	■	■	■	■	★	★	★	○	○	○	○	○	○	○	○
	0R - 31R File Register (serial)	○	○	○	○	○	○	○	○	○	○	■	■	■	■	■	■	★	★	★	○	○	○	○	○	○	○	○
	LS System Area	○	○	○	○	○	○	○	○	○	○	■	■	■	■	■	■	★	★	★	○	○	○	○	○	○	○	○

■ MELSEC- Q Series (Q Mode CPU)

		After Conversion																									
		X	Y	M	SM	L	F	V	S	B	SB	TS	TC	SS	SC	CS	CC	TN	SN	CN	D	SD	W	SW	R	0R 31R	LS
Before Conversion	X Input Relay	○	○	○	○	○	○	○	○	○	■	■	■	■	■	■	★	★	★	○	○	○	○	○	○	○	○
	Y Output Relay	○	○	○	○	○	○	○	○	○	■	■	■	■	■	■	★	★	★	○	○	○	○	○	○	○	○
	M Internal Relay	○	○	○	○	○	○	○	○	○	■	■	■	■	■	■	★	★	★	○	○	○	○	○	○	○	○
	SM Special Relay	○	○	○	○	○	○	○	○	○	■	■	■	■	■	■	★	★	★	○	○	○	○	○	○	○	○
	L Latch Relay	○	○	○	○	○	○	○	○	○	■	■	■	■	■	■	★	★	★	○	○	○	○	○	○	○	○
	F Annunciator	○	○	○	○	○	○	○	○	○	■	■	■	■	■	■	★	★	★	○	○	○	○	○	○	○	○
	V Edge Relay	○	○	○	○	○	○	○	○	○	■	■	■	■	■	■	★	★	★	○	○	○	○	○	○	○	○
	S Step Relay	○	○	○	○	○	○	○	○	○	■	■	■	■	■	■	★	★	★	○	○	○	○	○	○	○	○
	B Link Relay	○	○	○	○	○	○	○	○	○	■	■	■	■	■	■	★	★	★	○	○	○	○	○	○	○	○
	SB Special Link Relay	○	○	○	○	○	○	○	○	○	■	■	■	■	■	■	★	★	★	○	○	○	○	○	○	○	○
	TS Timer (contact)	■	■	■	■	■	■	■	■	■	■	■	■	■	■	■				■	■	■	■	■	■	■	■
	TC Timer (coil)	■	■	■	■	■	■	■	■	■	■	■	■	■	■	■				■	■	■	■	■	■	■	■
	SS Aggregate Timer (contact)	■	■	■	■	■	■	■	■	■	■	■	■	■	■	■				■	■	■	■	■	■	■	■
	SC Aggregate Timer (coil)	■	■	■	■	■	■	■	■	■	■	■	■	■	■	■				■	■	■	■	■	■	■	■
	CS Counter (contact)	■	■	■	■	■	■	■	■	■	■	■	■	■	■	■				■	■	■	■	■	■	■	■
	CC Counter (coil)	■	■	■	■	■	■	■	■	■	■	■	■	■	■	■				■	■	■	■	■	■	■	■
	TN Timer (current value)	★	★	★	★	★	★	★	★	★	★							★	★	★	★	★	★	★	★	★	★
	SN Aggregate Timer (current value)	★	★	★	★	★	★	★	★	★	★							★	★	★	★	★	★	★	★	★	★
	CN Counter (current value)	★	★	★	★	★	★	★	★	★	★							★	★	★	★	★	★	★	★	★	★
	D Data Register	○	○	○	○	○	○	○	○	○	○	■	■	■	■	■	■	★	★	★	○	○	○	○	○	○	○
	SD Special Data Register	○	○	○	○	○	○	○	○	○	○	■	■	■	■	■	■	★	★	★	○	○	○	○	○	○	○
	W Link Data Register	○	○	○	○	○	○	○	○	○	○	■	■	■	■	■	■	★	★	★	○	○	○	○	○	○	○
	SW Special Link Register	○	○	○	○	○	○	○	○	○	○	■	■	■	■	■	■	★	★	★	○	○	○	○	○	○	○
	R File Register (normal)	○	○	○	○	○	○	○	○	○	○	■	■	■	■	■	■	★	★	★	○	○	○	○	○	○	○
	0R - 31R File Register (serial)	○	○	○	○	○	○	○	○	○	○	■	■	■	■	■	■	★	★	★	○	○	○	○	○	○	○
LS System Area	○	○	○	○	○	○	○	○	○	○	■	■	■	■	■	■	★	★	★	○	○	○	○	○	○	○	

■ Mitsubishi Electric MELSEC-A/QnA/Q Series (MELSECNET/10)

		After Conversion																											
		X	Y	M	SM	L	F	B	SB	V	S	TS	TC	CS	CC	SS	SC	TN	CN	SN	D	SD	W	SW	R	LB	LW	LS	
Before Conversion	X Input Relay	○	○	○	○	○	○	○	○	○	■	■	■	■	■	■	★	★	★	○	○	○	○	○	○	○	○	○	○
	Y Output Relay	○	○	○	○	○	○	○	○	○	○	■	■	■	■	■	■	★	★	★	○	○	○	○	○	○	○	○	○
	M Internal Relay	○	○	○	○	○	○	○	○	○	○	■	■	■	■	■	■	★	★	★	○	○	○	○	○	○	○	○	○
	SM Special Relay	○	○	○	○	○	○	○	○	○	○	■	■	■	■	■	■	★	★	★	○	○	○	○	○	○	○	○	○
	L Latch Relay	○	○	○	○	○	○	○	○	○	○	■	■	■	■	■	■	★	★	★	○	○	○	○	○	○	○	○	○
	F Annunciator	○	○	○	○	○	○	○	○	○	○	■	■	■	■	■	■	★	★	★	○	○	○	○	○	○	○	○	○
	B Link Relay	○	○	○	○	○	○	○	○	○	○	■	■	■	■	■	■	★	★	★	○	○	○	○	○	○	○	○	○
	SB Special Link Relay	○	○	○	○	○	○	○	○	○	○	■	■	■	■	■	■	★	★	★	○	○	○	○	○	○	○	○	○
	V Edge Relay	○	○	○	○	○	○	○	○	○	○	■	■	■	■	■	■	★	★	★	○	○	○	○	○	○	○	○	○
	S Step Relay	○	○	○	○	○	○	○	○	○	○	■	■	■	■	■	■	★	★	★	○	○	○	○	○	○	○	○	○
	TS Timer (contact)	■	■	■	■	■	■	■	■	■	■	■	■	■	■	■	■				■	■	■	■	■	■	■	■	■
	TC Timer (coil)	■	■	■	■	■	■	■	■	■	■	■	■	■	■	■	■				■	■	■	■	■	■	■	■	■
	CS Counter (contact)	■	■	■	■	■	■	■	■	■	■	■	■	■	■	■	■				■	■	■	■	■	■	■	■	■
	CC Counter (coil)	■	■	■	■	■	■	■	■	■	■	■	■	■	■	■	■				■	■	■	■	■	■	■	■	■
	SS Aggregate Timer	■	■	■	■	■	■	■	■	■	■	■	■	■	■	■	■				■	■	■	■	■	■	■	■	■
	SC Aggregate Timer	■	■	■	■	■	■	■	■	■	■	■	■	■	■	■	■				■	■	■	■	■	■	■	■	■
	TN Timer (current)	★	★	★	★	★	★	★	★	★	★							★	★	★	★	★	★	★	★	★	★	★	★
	CN Counter (current)	★	★	★	★	★	★	★	★	★	★							★	★	★	★	★	★	★	★	★	★	★	★
	SN Aggregate Timer (current value)	★	★	★	★	★	★	★	★	★	★							★	★	★	★	★	★	★	★	★	★	★	★
	D Data Register	○	○	○	○	○	○	○	○	○	○	■	■	■	■	■	■	★	★	★	○	○	○	○	○	○	○	○	○
	SD Special Data Register	○	○	○	○	○	○	○	○	○	○	■	■	■	■	■	■	★	★	★	○	○	○	○	○	○	○	○	○
	W Link Data Register	○	○	○	○	○	○	○	○	○	○	■	■	■	■	■	■	★	★	★	○	○	○	○	○	○	○	○	○
	SW Special Link	○	○	○	○	○	○	○	○	○	○	■	■	■	■	■	■	★	★	★	○	○	○	○	○	○	○	○	○
	R File Register	○	○	○	○	○	○	○	○	○	○	■	■	■	■	■	■	★	★	★	○	○	○	○	○	○	○	○	○
	LB Internal Link Relay	○	○	○	○	○	○	○	○	○	○	■	■	■	■	■	■	★	★	★	○	○	○	○	○	○	○	○	○
	LW Internal Link Register	○	○	○	○	○	○	○	○	○	○	■	■	■	■	■	■	★	★	★	○	○	○	○	○	○	○	○	○
	LS System area	○	○	○	○	○	○	○	○	○	○	■	■	■	■	■	■	★	★	★	○	○	○	○	○	○	○	○	○

■ MELSEC-A/QnA/Q Series (CC-Link Intelligent Device Unit)

		After Conversion																								
		X	Y	M	S	L	B	S	T	T	S	S	C	C	T	S	C	D	S	W	S	R	R	R	R	L
Before Conversion	X Input Relay	<input type="checkbox"/>	<input type="checkbox"/>	<input type="checkbox"/>	<input type="checkbox"/>	<input type="checkbox"/>	<input type="checkbox"/>	<input type="checkbox"/>	<input type="checkbox"/>	<input type="checkbox"/>	<input type="checkbox"/>	<input type="checkbox"/>	<input type="checkbox"/>	<input type="checkbox"/>	<input type="checkbox"/>	<input type="checkbox"/>	<input type="checkbox"/>	<input type="checkbox"/>	<input type="checkbox"/>	<input type="checkbox"/>	<input type="checkbox"/>	<input type="checkbox"/>	<input type="checkbox"/>	<input type="checkbox"/>	<input type="checkbox"/>	<input type="checkbox"/>
	Y Output Relay	<input type="checkbox"/>	<input type="checkbox"/>	<input type="checkbox"/>	<input type="checkbox"/>	<input type="checkbox"/>	<input type="checkbox"/>	<input type="checkbox"/>	<input type="checkbox"/>	<input type="checkbox"/>	<input type="checkbox"/>	<input type="checkbox"/>	<input type="checkbox"/>	<input type="checkbox"/>	<input type="checkbox"/>	<input type="checkbox"/>	<input type="checkbox"/>	<input type="checkbox"/>	<input type="checkbox"/>	<input type="checkbox"/>	<input type="checkbox"/>	<input type="checkbox"/>	<input type="checkbox"/>	<input type="checkbox"/>	<input type="checkbox"/>	<input type="checkbox"/>
	M Internal Relay	<input type="checkbox"/>	<input type="checkbox"/>	<input type="checkbox"/>	<input type="checkbox"/>	<input type="checkbox"/>	<input type="checkbox"/>	<input type="checkbox"/>	<input type="checkbox"/>	<input type="checkbox"/>	<input type="checkbox"/>	<input type="checkbox"/>	<input type="checkbox"/>	<input type="checkbox"/>	<input type="checkbox"/>	<input type="checkbox"/>	<input type="checkbox"/>	<input type="checkbox"/>	<input type="checkbox"/>	<input type="checkbox"/>	<input type="checkbox"/>	<input type="checkbox"/>	<input type="checkbox"/>	<input type="checkbox"/>	<input type="checkbox"/>	<input type="checkbox"/>
	SM Special Relay	<input type="checkbox"/>	<input type="checkbox"/>	<input type="checkbox"/>	<input type="checkbox"/>	<input type="checkbox"/>	<input type="checkbox"/>	<input type="checkbox"/>	<input type="checkbox"/>	<input type="checkbox"/>	<input type="checkbox"/>	<input type="checkbox"/>	<input type="checkbox"/>	<input type="checkbox"/>	<input type="checkbox"/>	<input type="checkbox"/>	<input type="checkbox"/>	<input type="checkbox"/>	<input type="checkbox"/>	<input type="checkbox"/>	<input type="checkbox"/>	<input type="checkbox"/>	<input type="checkbox"/>	<input type="checkbox"/>	<input type="checkbox"/>	<input type="checkbox"/>
	L Latch Relay	<input type="checkbox"/>	<input type="checkbox"/>	<input type="checkbox"/>	<input type="checkbox"/>	<input type="checkbox"/>	<input type="checkbox"/>	<input type="checkbox"/>	<input type="checkbox"/>	<input type="checkbox"/>	<input type="checkbox"/>	<input type="checkbox"/>	<input type="checkbox"/>	<input type="checkbox"/>	<input type="checkbox"/>	<input type="checkbox"/>	<input type="checkbox"/>	<input type="checkbox"/>	<input type="checkbox"/>	<input type="checkbox"/>	<input type="checkbox"/>	<input type="checkbox"/>	<input type="checkbox"/>	<input type="checkbox"/>	<input type="checkbox"/>	<input type="checkbox"/>
	B Link Relay	<input type="checkbox"/>	<input type="checkbox"/>	<input type="checkbox"/>	<input type="checkbox"/>	<input type="checkbox"/>	<input type="checkbox"/>	<input type="checkbox"/>	<input type="checkbox"/>	<input type="checkbox"/>	<input type="checkbox"/>	<input type="checkbox"/>	<input type="checkbox"/>	<input type="checkbox"/>	<input type="checkbox"/>	<input type="checkbox"/>	<input type="checkbox"/>	<input type="checkbox"/>	<input type="checkbox"/>	<input type="checkbox"/>	<input type="checkbox"/>	<input type="checkbox"/>	<input type="checkbox"/>	<input type="checkbox"/>	<input type="checkbox"/>	<input type="checkbox"/>
	SB Special Link	<input type="checkbox"/>	<input type="checkbox"/>	<input type="checkbox"/>	<input type="checkbox"/>	<input type="checkbox"/>	<input type="checkbox"/>	<input type="checkbox"/>	<input type="checkbox"/>	<input type="checkbox"/>	<input type="checkbox"/>	<input type="checkbox"/>	<input type="checkbox"/>	<input type="checkbox"/>	<input type="checkbox"/>	<input type="checkbox"/>	<input type="checkbox"/>	<input type="checkbox"/>	<input type="checkbox"/>	<input type="checkbox"/>	<input type="checkbox"/>	<input type="checkbox"/>	<input type="checkbox"/>	<input type="checkbox"/>	<input type="checkbox"/>	<input type="checkbox"/>
	TS Timer (contact)	<input type="checkbox"/>	<input type="checkbox"/>	<input type="checkbox"/>	<input type="checkbox"/>	<input type="checkbox"/>	<input type="checkbox"/>	<input type="checkbox"/>	<input type="checkbox"/>	<input type="checkbox"/>	<input type="checkbox"/>	<input type="checkbox"/>	<input type="checkbox"/>	<input type="checkbox"/>	<input type="checkbox"/>	<input type="checkbox"/>	<input type="checkbox"/>	<input type="checkbox"/>	<input type="checkbox"/>	<input type="checkbox"/>	<input type="checkbox"/>	<input type="checkbox"/>	<input type="checkbox"/>	<input type="checkbox"/>	<input type="checkbox"/>	<input type="checkbox"/>
	TC Timer (coil)	<input type="checkbox"/>	<input type="checkbox"/>	<input type="checkbox"/>	<input type="checkbox"/>	<input type="checkbox"/>	<input type="checkbox"/>	<input type="checkbox"/>	<input type="checkbox"/>	<input type="checkbox"/>	<input type="checkbox"/>	<input type="checkbox"/>	<input type="checkbox"/>	<input type="checkbox"/>	<input type="checkbox"/>	<input type="checkbox"/>	<input type="checkbox"/>	<input type="checkbox"/>	<input type="checkbox"/>	<input type="checkbox"/>	<input type="checkbox"/>	<input type="checkbox"/>	<input type="checkbox"/>	<input type="checkbox"/>	<input type="checkbox"/>	<input type="checkbox"/>
	SS Aggregate Timer (contact)	<input type="checkbox"/>	<input type="checkbox"/>	<input type="checkbox"/>	<input type="checkbox"/>	<input type="checkbox"/>	<input type="checkbox"/>	<input type="checkbox"/>	<input type="checkbox"/>	<input type="checkbox"/>	<input type="checkbox"/>	<input type="checkbox"/>	<input type="checkbox"/>	<input type="checkbox"/>	<input type="checkbox"/>	<input type="checkbox"/>	<input type="checkbox"/>	<input type="checkbox"/>	<input type="checkbox"/>	<input type="checkbox"/>	<input type="checkbox"/>	<input type="checkbox"/>	<input type="checkbox"/>	<input type="checkbox"/>	<input type="checkbox"/>	<input type="checkbox"/>
	SC Aggregate Timer (coil)	<input type="checkbox"/>	<input type="checkbox"/>	<input type="checkbox"/>	<input type="checkbox"/>	<input type="checkbox"/>	<input type="checkbox"/>	<input type="checkbox"/>	<input type="checkbox"/>	<input type="checkbox"/>	<input type="checkbox"/>	<input type="checkbox"/>	<input type="checkbox"/>	<input type="checkbox"/>	<input type="checkbox"/>	<input type="checkbox"/>	<input type="checkbox"/>	<input type="checkbox"/>	<input type="checkbox"/>	<input type="checkbox"/>	<input type="checkbox"/>	<input type="checkbox"/>	<input type="checkbox"/>	<input type="checkbox"/>	<input type="checkbox"/>	<input type="checkbox"/>
	CS Counter (contact)	<input type="checkbox"/>	<input type="checkbox"/>	<input type="checkbox"/>	<input type="checkbox"/>	<input type="checkbox"/>	<input type="checkbox"/>	<input type="checkbox"/>	<input type="checkbox"/>	<input type="checkbox"/>	<input type="checkbox"/>	<input type="checkbox"/>	<input type="checkbox"/>	<input type="checkbox"/>	<input type="checkbox"/>	<input type="checkbox"/>	<input type="checkbox"/>	<input type="checkbox"/>	<input type="checkbox"/>	<input type="checkbox"/>	<input type="checkbox"/>	<input type="checkbox"/>	<input type="checkbox"/>	<input type="checkbox"/>	<input type="checkbox"/>	<input type="checkbox"/>
	CC Counter (coil)	<input type="checkbox"/>	<input type="checkbox"/>	<input type="checkbox"/>	<input type="checkbox"/>	<input type="checkbox"/>	<input type="checkbox"/>	<input type="checkbox"/>	<input type="checkbox"/>	<input type="checkbox"/>	<input type="checkbox"/>	<input type="checkbox"/>	<input type="checkbox"/>	<input type="checkbox"/>	<input type="checkbox"/>	<input type="checkbox"/>	<input type="checkbox"/>	<input type="checkbox"/>	<input type="checkbox"/>	<input type="checkbox"/>	<input type="checkbox"/>	<input type="checkbox"/>	<input type="checkbox"/>	<input type="checkbox"/>	<input type="checkbox"/>	<input type="checkbox"/>
	TN Timer (current value)	<input type="checkbox"/>	<input type="checkbox"/>	<input type="checkbox"/>	<input type="checkbox"/>	<input type="checkbox"/>	<input type="checkbox"/>	<input type="checkbox"/>	<input type="checkbox"/>	<input type="checkbox"/>	<input type="checkbox"/>	<input type="checkbox"/>	<input type="checkbox"/>	<input type="checkbox"/>	<input type="checkbox"/>	<input type="checkbox"/>	<input type="checkbox"/>	<input type="checkbox"/>	<input type="checkbox"/>	<input type="checkbox"/>	<input type="checkbox"/>	<input type="checkbox"/>	<input type="checkbox"/>	<input type="checkbox"/>	<input type="checkbox"/>	<input type="checkbox"/>
	SN Aggregate Timer (current value)	<input type="checkbox"/>	<input type="checkbox"/>	<input type="checkbox"/>	<input type="checkbox"/>	<input type="checkbox"/>	<input type="checkbox"/>	<input type="checkbox"/>	<input type="checkbox"/>	<input type="checkbox"/>	<input type="checkbox"/>	<input type="checkbox"/>	<input type="checkbox"/>	<input type="checkbox"/>	<input type="checkbox"/>	<input type="checkbox"/>	<input type="checkbox"/>	<input type="checkbox"/>	<input type="checkbox"/>	<input type="checkbox"/>	<input type="checkbox"/>	<input type="checkbox"/>	<input type="checkbox"/>	<input type="checkbox"/>	<input type="checkbox"/>	<input type="checkbox"/>
	CN Counter (current value)	<input type="checkbox"/>	<input type="checkbox"/>	<input type="checkbox"/>	<input type="checkbox"/>	<input type="checkbox"/>	<input type="checkbox"/>	<input type="checkbox"/>	<input type="checkbox"/>	<input type="checkbox"/>	<input type="checkbox"/>	<input type="checkbox"/>	<input type="checkbox"/>	<input type="checkbox"/>	<input type="checkbox"/>	<input type="checkbox"/>	<input type="checkbox"/>	<input type="checkbox"/>	<input type="checkbox"/>	<input type="checkbox"/>	<input type="checkbox"/>	<input type="checkbox"/>	<input type="checkbox"/>	<input type="checkbox"/>	<input type="checkbox"/>	<input type="checkbox"/>
	D Data Register	<input type="checkbox"/>	<input type="checkbox"/>	<input type="checkbox"/>	<input type="checkbox"/>	<input type="checkbox"/>	<input type="checkbox"/>	<input type="checkbox"/>	<input type="checkbox"/>	<input type="checkbox"/>	<input type="checkbox"/>	<input type="checkbox"/>	<input type="checkbox"/>	<input type="checkbox"/>	<input type="checkbox"/>	<input type="checkbox"/>	<input type="checkbox"/>	<input type="checkbox"/>	<input type="checkbox"/>	<input type="checkbox"/>	<input type="checkbox"/>	<input type="checkbox"/>	<input type="checkbox"/>	<input type="checkbox"/>	<input type="checkbox"/>	<input type="checkbox"/>
	SD Special Data Register	<input type="checkbox"/>	<input type="checkbox"/>	<input type="checkbox"/>	<input type="checkbox"/>	<input type="checkbox"/>	<input type="checkbox"/>	<input type="checkbox"/>	<input type="checkbox"/>	<input type="checkbox"/>	<input type="checkbox"/>	<input type="checkbox"/>	<input type="checkbox"/>	<input type="checkbox"/>	<input type="checkbox"/>	<input type="checkbox"/>	<input type="checkbox"/>	<input type="checkbox"/>	<input type="checkbox"/>	<input type="checkbox"/>	<input type="checkbox"/>	<input type="checkbox"/>	<input type="checkbox"/>	<input type="checkbox"/>	<input type="checkbox"/>	<input type="checkbox"/>
	W Link Data Register	<input type="checkbox"/>	<input type="checkbox"/>	<input type="checkbox"/>	<input type="checkbox"/>	<input type="checkbox"/>	<input type="checkbox"/>	<input type="checkbox"/>	<input type="checkbox"/>	<input type="checkbox"/>	<input type="checkbox"/>	<input type="checkbox"/>	<input type="checkbox"/>	<input type="checkbox"/>	<input type="checkbox"/>	<input type="checkbox"/>	<input type="checkbox"/>	<input type="checkbox"/>	<input type="checkbox"/>	<input type="checkbox"/>	<input type="checkbox"/>	<input type="checkbox"/>	<input type="checkbox"/>	<input type="checkbox"/>	<input type="checkbox"/>	<input type="checkbox"/>
	SW Special Link Register	<input type="checkbox"/>	<input type="checkbox"/>	<input type="checkbox"/>	<input type="checkbox"/>	<input type="checkbox"/>	<input type="checkbox"/>	<input type="checkbox"/>	<input type="checkbox"/>	<input type="checkbox"/>	<input type="checkbox"/>	<input type="checkbox"/>	<input type="checkbox"/>	<input type="checkbox"/>	<input type="checkbox"/>	<input type="checkbox"/>	<input type="checkbox"/>	<input type="checkbox"/>	<input type="checkbox"/>	<input type="checkbox"/>	<input type="checkbox"/>	<input type="checkbox"/>	<input type="checkbox"/>	<input type="checkbox"/>	<input type="checkbox"/>	<input type="checkbox"/>
	R File Register	<input type="checkbox"/>	<input type="checkbox"/>	<input type="checkbox"/>	<input type="checkbox"/>	<input type="checkbox"/>	<input type="checkbox"/>	<input type="checkbox"/>	<input type="checkbox"/>	<input type="checkbox"/>	<input type="checkbox"/>	<input type="checkbox"/>	<input type="checkbox"/>	<input type="checkbox"/>	<input type="checkbox"/>	<input type="checkbox"/>	<input type="checkbox"/>	<input type="checkbox"/>	<input type="checkbox"/>	<input type="checkbox"/>	<input type="checkbox"/>	<input type="checkbox"/>	<input type="checkbox"/>	<input type="checkbox"/>	<input type="checkbox"/>	<input type="checkbox"/>
	RX Remote Input	<input type="checkbox"/>	<input type="checkbox"/>	<input type="checkbox"/>	<input type="checkbox"/>	<input type="checkbox"/>	<input type="checkbox"/>	<input type="checkbox"/>	<input type="checkbox"/>	<input type="checkbox"/>	<input type="checkbox"/>	<input type="checkbox"/>	<input type="checkbox"/>	<input type="checkbox"/>	<input type="checkbox"/>	<input type="checkbox"/>	<input type="checkbox"/>	<input type="checkbox"/>	<input type="checkbox"/>	<input type="checkbox"/>	<input type="checkbox"/>	<input type="checkbox"/>	<input type="checkbox"/>	<input type="checkbox"/>	<input type="checkbox"/>	<input type="checkbox"/>
	RY Remote Output	<input type="checkbox"/>	<input type="checkbox"/>	<input type="checkbox"/>	<input type="checkbox"/>	<input type="checkbox"/>	<input type="checkbox"/>	<input type="checkbox"/>	<input type="checkbox"/>	<input type="checkbox"/>	<input type="checkbox"/>	<input type="checkbox"/>	<input type="checkbox"/>	<input type="checkbox"/>	<input type="checkbox"/>	<input type="checkbox"/>	<input type="checkbox"/>	<input type="checkbox"/>	<input type="checkbox"/>	<input type="checkbox"/>	<input type="checkbox"/>	<input type="checkbox"/>	<input type="checkbox"/>	<input type="checkbox"/>	<input type="checkbox"/>	<input type="checkbox"/>
	RWw Remote Register	<input type="checkbox"/>	<input type="checkbox"/>	<input type="checkbox"/>	<input type="checkbox"/>	<input type="checkbox"/>	<input type="checkbox"/>	<input type="checkbox"/>	<input type="checkbox"/>	<input type="checkbox"/>	<input type="checkbox"/>	<input type="checkbox"/>	<input type="checkbox"/>	<input type="checkbox"/>	<input type="checkbox"/>	<input type="checkbox"/>	<input type="checkbox"/>	<input type="checkbox"/>	<input type="checkbox"/>	<input type="checkbox"/>	<input type="checkbox"/>	<input type="checkbox"/>	<input type="checkbox"/>	<input type="checkbox"/>	<input type="checkbox"/>	<input type="checkbox"/>
RWr Remote Register	<input type="checkbox"/>	<input type="checkbox"/>	<input type="checkbox"/>	<input type="checkbox"/>	<input type="checkbox"/>	<input type="checkbox"/>	<input type="checkbox"/>	<input type="checkbox"/>	<input type="checkbox"/>	<input type="checkbox"/>	<input type="checkbox"/>	<input type="checkbox"/>	<input type="checkbox"/>	<input type="checkbox"/>	<input type="checkbox"/>	<input type="checkbox"/>	<input type="checkbox"/>	<input type="checkbox"/>	<input type="checkbox"/>	<input type="checkbox"/>	<input type="checkbox"/>	<input type="checkbox"/>	<input type="checkbox"/>	<input type="checkbox"/>	<input type="checkbox"/>	
LS System area	<input type="checkbox"/>	<input type="checkbox"/>	<input type="checkbox"/>	<input type="checkbox"/>	<input type="checkbox"/>	<input type="checkbox"/>	<input type="checkbox"/>	<input type="checkbox"/>	<input type="checkbox"/>	<input type="checkbox"/>	<input type="checkbox"/>	<input type="checkbox"/>	<input type="checkbox"/>	<input type="checkbox"/>	<input type="checkbox"/>	<input type="checkbox"/>	<input type="checkbox"/>	<input type="checkbox"/>	<input type="checkbox"/>	<input type="checkbox"/>	<input type="checkbox"/>	<input type="checkbox"/>	<input type="checkbox"/>	<input type="checkbox"/>	<input type="checkbox"/>	

■ Omron SYSMAC C/α/CV

		After Conversion								
		CH	LR	AR	HR	A	TIM /T	CNT /C	D	LS
Before Conversion	CH Relay	○	○	○	○	○	◆	◆	○	○
	LR Data Link Relay	○	○	○	○	○	◆	◆	○	○
	AR Auxiliary Memory Relay	○	○	○	○	○	◆	◆	○	○
	HR Hold Relay	○	○	○	○	○	◆	◆	○	○
	A Special Auxiliary Relay	○	○	○	○	○	◆	◆	○	○
	TIM/T Timer	◆	◆	◆	◆	◆	○	○	◆	◆
	CNT/C Counter	◆	◆	◆	◆	◆	○	○	◆	◆
	D Data Memory	○	○	○	○	○	◆	◆	○	○
	LS System Area	○	○	○	○	○	◆	◆	○	○

LR (Data Link Relay), AR (Auxiliary Memory Relay) and HR (Hold Relay) are only for SYSMAC C/SYSMAC-α. A (Special Auxiliary Relay) is only for SYSMAC CV.

■ Omron SYSMAC CS1

		After Conversion														
		-	W	H	A	T (contact)	C (contact)	T (current)	C (current)	D	E	EM	TK	IR	DR	LS
Before Conversion	Channel I/O		○	○	○	■	■	★	★	◆	○	○	○	○	○	○
	W Internal Auxiliary Relay	○	○	○	○	■	■	★	★	◆	○	○	○	○	○	○
	H Hold Relay	○	○	○	○	■	■	★	★	◆	○	○	○	○	○	○
	A Special Auxiliary Relay	○	○	○	○	■	■	★	★	◆	○	○	○	○	○	○
	T Timer (contact)	■	■	■	■	■	■			■	■	■	■	■	■	■
	C Counter (contact)	■	■	■	■	■	■			■	■	■	■	■	■	■
	T Timer (current value)	★	★	★	★			★	★	★	★	★	★	★	★	★
	C Counter (current value)	★	★	★	★			★	★	★	★	★	★	★	★	★
	D Data Memory	◆	◆	◆	◆	■	■	★	★	◆	◆	◆	◆	◆	◆	◆
	E0 ~ EC Extended Data Memory	○	○	○	○	■	■	★	★	◆	○	○	○	○	○	○
	EM Extended Data Memory	○	○	○	○	■	■	★	★	◆	○	○	○	○	○	○
	TK Task Flag	○	○	○	○	■	■	★	★	◆	○	○	○	○	○	○
	IR Index Register	○	○	○	○	■	■	★	★	◆	○	○	○	○	○	○
	DR Data Register	○	○	○	○	■	■	★	★	◆	○	○	○	○	○	○
LS System Area	○	○	○	○	■	■	★	★	◆	○	○	○	○	○	○	

■ Omron THERMAC NEO Controller

		After Conversion				
		C0	C1	C3	A	LS
Before Conversion	C0	○	○	○	○	○
	C1	○	○	○	○	○
	C3	○	○	○	○	○
	A	○	○	○	○	○
	LS	○	○	○	○	○

■ Fuji Electric MICREX-F/MICREX-F FLT-ASFK

		After Conversion										
		B/M/K/D/L	W24	F	A	TR	TS	CR	CS	BD/DI/SI	W30~W34	LS
Before Conversion	B/M/K/D/L Relay	○	○	○	○	◆	◆	◆	◆	○	○	○
	W24 Direct I/O	○	○	○	○	◆	◆	◆	◆	○	○	○
	F Special Relay	○	○	○	○	◆	◆	◆	◆	○	○	○
	A Announce Relay	○	○	○	○	◆	◆	◆	◆	○	○	○
	TR Timer (current)	◆	◆	◆	◆	○	★	○	★	◆	◆	◆
	TS Timer (setup)	◆	◆	◆	◆	★	○	★)	◆	◆	◆
	CR Counter (current)	◆	◆	◆	◆	○	★	○	★	◆	◆	◆
	CS Counter (setup)	◆	◆	◆	◆	★	○	★	○	◆	◆	◆
	BD/DI/SI Data Memory	○	○	○	○	◆	◆	◆	◆	○	○	○
	W30 ~ W34 File Memory	○	○	○	○	◆	◆	◆	◆	○	○	○
	LS System Area	○	○	○	○	◆	◆	◆	◆	○	○	○

■ Fuji Electric FLEX-PC

		After Conversion									
		X	Y	M	L	T/TS	C/CS	D	W	R	LS
Before Conversion	X Input Relay	○	○	○	○	◆	◆	○	○	○	○
	Y Output Relay	○	○	○	○	◆	◆	○	○	○	○
	M Internal Relay	○	○	○	○	◆	◆	○	○	○	○
	L Latch Relay	○	○	○	○	◆	◆	○	○	○	○
	T/TS Timer	◆	◆	◆	◆	◆	◆	◆	◆	◆	◆
	C/CS Counter	◆	◆	◆	◆	◆	◆	◆	◆	◆	◆
	D Data Register	○	○	○	○	◆	◆	○	○	○	○
	W Link Register	○	○	○	○	◆	◆	○	○	○	○
	R File Register	○	○	○	○	◆	◆	○	○	○	○
	LS System Area	○	○	○	○	◆	◆	○	○	○	○

■ Fuji Electric FRENICS, FVR Series

		After Conversion									
		F	E	C	P	H	A	o	S	M	LS
Before Conversion	Fundamental Function F	○	○	○	○	○	○	○	○	○	○
	Terminal Function E	○	○	○	○	○	○	○	○	○	○
	Control Function C	○	○	○	○	○	○	○	○	○	○
	Motor 1 P	○	○	○	○	○	○	○	○	○	○
	High-level Function H	○	○	○	○	○	○	○	○	○	○
	Motor 2 A	○	○	○	○	○	○	○	○	○	○
	Option O	○	○	○	○	○	○	○	○	○	○
	Command Data S	○	○	○	○	○	○	○	○	○	○
	Monitor Data M	○	○	○	○	○	○	○	○	○	○
	System Area LS	○	○	○	○	○	○	○	○	○	○

■ Yasukawa Electric Memocon-SC

		After Conversion								
		Coil	Input Relay	Link Coil	Input Register	Output/Keep Register	Link Register	Constant Register	Ext. Register	LS System Area
Before Conversion	Coil	○	○	○	○	○	○	○	○	○
	Input Relay	○	○	○	○	○	○	○	○	○
	Link Coil	○	○	○	○	○	○	○	○	○
	Input Register	○	○	○	○	○	○	○	○	○
	Output/Keep Register	○	○	○	○	○	○	○	○	○
	Link Register	○	○	○	○	○	○	○	○	○
	Constant Register	○	○	○	○	○	○	○	○	○
	Ext. Register	○	○	○	○	○	○	○	○	○
	LS System Area	○	○	○	○	○	○	○	○	○

■ Yasukawa Electric PROGIC-8

		After Conversion											
		O	I	N	D	W	SW	DW	Z	R	SR	DR	LS
Before Conversion	O Output	○	○	○	○	○	○	○	○	○	○	○	○
	I Input	○	○	○	○	○	○	○	○	○	○	○	○
	N Current Value Register	○	○	○	○	○	○	○	○	○	○	○	○
	D Data Memory	○	○	○	○	○	○	○	○	○	○	○	○
	W Link Register	○	○	○	○	○	○	○	○	○	○	○	○
	SW System Register	○	○	○	○	○	○	○	○	○	○	○	○
	DW Register	○	○	○	○	○	○	○	○	○	○	○	○
	Z Link Relay	○	○	○	○	○	○	○	○	○	○	○	○
	R Internal Relay	○	○	○	○	○	○	○	○	○	○	○	○
	SR Stage Relay	○	○	○	○	○	○	○	○	○	○	○	○
	DR Data Register	○	○	○	○	○	○	○	○	○	○	○	○
	LS System Area	○	○	○	○	○	○	○	○	○	○	○	○

■ Yasukawa Electric GL 120/130

		After Conversion												
		O	I	D	X	Y	M	P	Q	3	4	R	7	LS
Before Conversion	O Output Relay	○	○	○	○	○	○	○	○	○	○	○	○	○
	I Input Relay	○	○	○	○	○	○	○	○	○	○	○	○	○
	D Data Memory	○	○	○	○	○	○	○	○	○	○	○	○	○
	X Input Relay	○	○	○	○	○	○	○	○	○	○	○	○	○
	Y Output Relay	○	○	○	○	○	○	○	○	○	○	○	○	○
	M Internal Relay	○	○	○	○	○	○	○	○	○	○	○	○	○
	P Relay	○	○	○	○	○	○	○	○	○	○	○	○	○
	Q Relay	○	○	○	○	○	○	○	○	○	○	○	○	○
	3	○	○	○	○	○	○	○	○	○	○	○	○	○
	4	○	○	○	○	○	○	○	○	○	○	○	○	○
	R Link Register	○	○	○	○	○	○	○	○	○	○	○	○	○
	7	○	○	○	○	○	○	○	○	○	○	○	○	○
	LS System Area	○	○	○	○	○	○	○	○	○	○	○	○	○

■ Yasukawa Electric CP-9200SH

		After Conversion				
		X	Y	M	T/C	LS
Before Conversion	GMB Output Coil	○	○	○	○	○
	GIB Input Coil	○	○	○	○	○
	GMW Hold Register	○	○	○	○	○
	GIW Input Register	○	○	○	○	○
	LS System Area	○	○	○	○	○

■ Hitachi Ltd. HIDIC S10 α

		After Conversion																			
		X	Y	R	G	E	K	T	U	C	TC	TS	UC	US	CC	CS	DW	SW	EW	FW	MS
Before Conversion	X Input Relay	○	○	○	○	○	○	○	○	○	★	★	★	★	★	○	○	○	○	○	○
	Y Output Relay	○	○	○	○	○	○	○	○	○	★	★	★	★	★	○	○	○	○	○	○
	R Internal Relay	○	○	○	○	○	○	○	○	○	★	★	★	★	★	○	○	○	○	○	○
	G Global Link	○	○	○	○	○	○	○	○	○	★	★	★	★	★	○	○	○	○	○	○
	SW System Register	○	○	○	○	○	○	○	○	○	★	★	★	★	★	○	○	○	○	○	○
	EW E word	○	○	○	○	○	○	○	○	○	★	★	★	★	★	○	○	○	○	○	○
	E Event	○	○	○	○	○	○	○	○	○	★	★	★	★	★	○	○	○	○	○	○
	K Keep Relay	○	○	○	○	○	○	○	○	○	★	★	★	★	★	○	○	○	○	○	○
	T On-Delay Timer	○	○	○	○	○	○	○	○	○	★	★	★	★	★	○	○	○	○	○	○
	U One-shot Timer	○	○	○	○	○	○	○	○	○	★	★	★	★	★	○	○	○	○	○	○
	C Up/down Counter	○	○	○	○	○	○	○	○	○	★	★	★	★	★	○	○	○	○	○	○
	TC On-delay Timer (calculated)	★	★	★	★	★	★	★	★	★	★	★	★	★	★	★	★	★	★	★	★
	TS On-delay Timer (setup)	★	★	★	★	★	★	★	★	★	★	★	★	★	★	★	★	★	★	★	★
	UC One-shot Timer (calculated)	★	★	★	★	★	★	★	★	★	★	★	★	★	★	★	★	★	★	★	★
	US One-shot Timer (setup)	★	★	★	★	★	★	★	★	★	★	★	★	★	★	★	★	★	★	★	★
	CC Up/down Counter (calculated)	★	★	★	★	★	★	★	★	★	★	★	★	★	★	★	★	★	★	★	★
	CS Up/down Counter (setup)	★	★	★	★	★	★	★	★	★	★	★	★	★	★	★	★	★	★	★	★
	DW Data Register	○	○	○	○	○	○	○	○	○	★	★	★	★	★	○	○	○	○	○	○
	FW Work Register	○	○	○	○	○	○	○	○	○	★	★	★	★	★	○	○	○	○	○	○
	MS Extended Register	○	○	○	○	○	○	○	○	○	★	★	★	★	★	○	○	○	○	○	○
LS System Area	○	○	○	○	○	○	○	○	○	★	★	★	★	★	○	○	○	○	○	○	

■ Hitachi Ltd. HIDIC H (HIZAC H)/HIDIC H2

		After Conversion								
		X	Y	R	L	M	T/C	WR	WN	LS
Before Conversion	X Input	○	○	■	○	○	◆	○	○	○
	Y Output	○	○	■	○	○	◆	○	○	○
	R Internal Output	■	■	■	■	■	■	■	■	■
	L CPU Link	○	○	■	○	○	◆	○	○	○
	M Data Area	○	○	■	○	○	◆	○	○	○
	T/C *1 Timer/Counter	◆	◆	■	◆	◆	○	★	★	◆
	WR Word Internal Output	○	○	■	○	○	★	◆	○	○
	WN Network Area	○	○	■	○	○	★	○	○	○
	LS System Area	○	○	■	○	○	◆	○	○	○

■ Hitachi Ltd. HIZAC EC

		After Conversion				
		X	Y	M	T/C	LS
Before Conversion	X External Input	○	○	○	◆	○
	Y External Output	○	○	○	◆	○
	M Internal Output	○	○	○	◆	○
	T/C Timer/Counter	◆	◆	◆	◆	◆
	LS System Area	○	○	○	◆	○

*1: TD/SS/WDT/MS/TMR for Timers. CU/RCU/CT for counters.

■ Sharp New Satellite JW

		After Conversion							
		A	T (contact)	C	T (current)	B	Register	File Register	LS
Before Conversion	A Relay	○	■	■	◆	○	○	○	○
	T Timer (contact)	'	■	■		■	■	■	■
	C Counter (contact)	'	■	■		■	■	■	■
	T Timer/Counter (current)	◆	■	■	◆	◆	◆	◆	◆
	B Timer/Counter (current)	○	■	■	■	○	○	○	○
	Register	○	■	■	■	○	○	○	○
	File Register	○	■	■	■	○	○	○	○
	LS System Area	○	■	■	■	○	○	○	○

■ Matsushita Electric Works MEWNET

		After Conversion										
		X	Y	R	L	EV	SV	DT	Ld	FL	LS	R9
Before Conversion	X Input Relay	○	○	○	○	◆	◆	○	○	○	○	○
	Y Output Relay	○	○	○	○	◆	◆	○	○	○	○	○
	R Internal/Special Relay	○	○	○	○	◆	◆	○	○	○	○	○
	L Link Relay	○	○	○	○	◆	◆	○	○	○	○	○
	EV Timer/Counter (elapsed value)	◆	◆	◆	◆	○	○	◆	◆	◆	◆	◆
	SV Timer/Counter (setup)	◆	◆	◆	◆	○	○	◆	◆	◆	◆	◆
	DT Data Register	○	○	○	○	◆	◆	○	○	○	○	○
	Ld Link Register	○	○	○	○	◆	◆	○	○	○	○	○
	FL File Register	○	○	○	○	◆	◆	○	○	○	○	○
	LS System Area	○	○	○	○	◆	◆	○	○	○	○	○
	Rq Special Relay	○	○	○	○	◆	◆	○	○	○	○	○

■ Yokogawa Electric FACTORY ACE

		After Conversion																	
		X	Y	I	E	M	L	T	C	TP	CP	TS	CS	D	B	R	Z	W	LS
Before Conversion	X Input Relay	○	○	○	○	○	○	■	■	★	★	★	★	○	○	○	○	○	○
	Y Output Relay	○	○	○	○	○	○	■	■	★	★	★	★	○	○	○	○	○	○
	I Internal Relay	○	○	○	○	○	○	■	■	★	★	★	★	○	○	○	○	○	○
	E Common Relay	○	○	○	○	○	○	■	■	★	★	★	★	○	○	○	○	○	○
	M Special Relay	○	○	○	○	○	○	■	■	★	★	★	★	○	○	○	○	○	○
	L Link Relay	○	○	○	○	○	○	■	■	★	★	★	★	○	○	○	○	○	○
	T Timer (contact)	■	■	■	■	■	■	■	■					■	■	■	■	■	■
	C Counter (contact)	■	■	■	■	■	■	■	■					■	■	■	■	■	■
	TP Timer (current)	★	★	★	★	★	★			★	★	★	★	○	○	○	○	○	○
	CP Counter (current)	★	★	★	★	★	★			★	★	★	★	○	○	○	○	○	○
	TS Timer (setup)	★	★	★	★	★	★			★	★	★	★	○	○	○	○	○	○
	CS Counter (setup)	★	★	★	★	★	★			★	★	★	★	○	○	○	○	○	○
	D Data Register	○	○	○	○	○	○	■	■	★	★	★	★	○	○	○	○	○	○
	B File Register	○	○	○	○	○	○	■	■	★	★	★	★	○	○	○	○	○	○
	R Joint Register	○	○	○	○	○	○	■	■	★	★	★	★	○	○	○	○	○	○
	Z Special Register	○	○	○	○	○	○	■	■	★	★	★	★	○	○	○	○	○	○
W Link Register	○	○	○	○	○	○	■	■	★	★	★	★	○	○	○	○	○	○	
LS System Area	○	○	○	○	○	○	■	■	★	★	★	★	○	○	○	○	○	○	

R Joint Register is only for FA-M3.

■ Yokogawa Electric UT2000/Yokogawa M&C Green Series

		After Conversion		
		D	I	LS
Before Conversion	D D Register	○	○	○
	I I Relay	○	○	○
	LS System Area	○	○	○

■ Yokogawa Electric FA-M3 Ether

		After Conversion																	
		X	Y	I	E	M	L	T	C	TP	CP	TS	CS	D	B	R	Z	W	LS
Before Conversion	X Input Relay	○	○	○	○	○	○	■	■	★	★	★	★	○	○	○	○	○	○
	Y Output Relay	○	○	○	○	○	○	■	■	★	★	★	★	○	○	○	○	○	○
	I Internal Relay	○	○	○	○	○	○	■	■	★	★	★	★	○	○	○	○	○	○
	E Common Relay	○	○	○	○	○	○	■	■	★	★	★	★	○	○	○	○	○	○
	M Special Relay	○	○	○	○	○	○	■	■	★	★	★	★	○	○	○	○	○	○
	L Link Relay	○	○	○	○	○	○	■	■	★	★	★	★	○	○	○	○	○	○
	T Timer (contact)	■	■	■	■	■	■	■	■					■	■	■	■	■	■
	C Counter (contact)	■	■	■	■	■	■	■	■					■	■	■	■	■	■
	TP Timer (current value)	★	★	★	★	★	★			★	★	★	★	○	○	○	○	○	○
	CP Counter (current value)	★	★	★	★	★	★			★	★	★	★	○	○	○	○	○	○
	TS Timer (set value)	★	★	★	★	★	★			★	★	★	★	○	○	○	○	○	○
	CS Counter (set value)	★	★	★	★	★	★			★	★	★	★	○	○	○	○	○	○
	D Data Register	○	○	○	○	○	○	■	■	★	★	★	★	○	○	○	○	○	○
	B File Register	○	○	○	○	○	○	■	■	★	★	★	★	○	○	○	○	○	○
	R Joint Register	○	○	○	○	○	○	■	■	★	★	★	★	○	○	○	○	○	○
	Z Special Register	○	○	○	○	○	○	■	■	★	★	★	★	○	○	○	○	○	○
	W Link Register	○	○	○	○	○	○	■	■	★	★	★	★	○	○	○	○	○	○
	LS System Area	○	○	○	○	○	○	■	■	★	★	★	★	○	○	○	○	○	○

■ Toyota Machine Works TOYOPUC-PC2

		After Conversion											
		X	Y	M	K	L	C	N	D	R	B	S	LS
Before Conversion	X Input Relay	○	○	○	○	○	○	★	○	○	○	○	○
	Y Output Relay	○	○	○	○	○	○	★	○	○	○	○	○
	M Internal Relay	○	○	○	○	○	○	★	○	○	○	○	○
	K Keep Relay	○	○	○	○	○	○	★	○	○	○	○	○
	L Link Relay	○	○	○	○	○	○	★	○	○	○	○	○
	V Special Relay	○	○	○	○	○	○	★	○	○	○	○	○
	N Current Value Register	★	★	★	★	★	★	○	★	★	★	★	★
	D Data Register	○	○	○	○	○	○	★	○	○	○	○	○
	R Link Register	○	○	○	○	○	○	★	○	○	○	○	○
	B File Register	○	○	○	○	○	○	★	○	○	○	○	○
	S Special Register	○	○	○	○	○	○	★	○	○	○	○	○
	LS System Area	○	○	○	○	○	○	★	○	○	○	○	○

■ Toyota Machine Works TOYOPUC-PC3 (PC3-J Series)

		After Conversion																											
		X	Y	M	K	L	V	P	T	C	D	R	S	N	B	EX	EY	EM	EK	EL	EV	EP	ET	EC	ES	EN	H	U	LS
Before Conversion	X Input	○	○	○	○	○	■	○	○	○	○	○	○	○	○	○	○	○	○	○	○	■	○	○	○	○	○	○	○
	Y Output	○	○	○	○	○	■	○	○	○	○	○	○	○	○	○	○	○	○	○	○	■	○	○	○	○	○	○	○
	M Internal Relay	○	○	○	○	○	■	○	○	○	○	○	○	○	○	○	○	○	○	○	○	■	○	○	○	○	○	○	○
	K Keep Relay	○	○	○	○	○	■	○	○	○	○	○	○	○	○	○	○	○	○	○	○	■	○	○	○	○	○	○	○
	L Link Relay	○	○	○	○	○	■	○	○	○	○	○	○	○	○	○	○	○	○	○	○	■	○	○	○	○	○	○	○
	V Special Relay	○	○	○	○	○	■	○	○	○	○	○	○	○	○	○	○	○	○	○	○	■	○	○	○	○	○	○	○
	P Edge Detection	■	■	■	■	■	■	■	■	■	■	■	■	■	■	■	■	■	■	■	■	■	■	■	■	■	■	■	■
	T Timer	○	○	○	○	○	■	○	○	○	○	○	○	○	○	○	○	○	○	○	○	■	○	○	○	○	○	○	○
	C Counter	○	○	○	○	○	■	○	○	○	○	○	○	○	○	○	○	○	○	○	○	■	○	○	○	○	○	○	○
	D Data Register	○	○	○	○	○	■	○	○	○	○	○	○	○	○	○	○	○	○	○	○	■	○	○	○	○	○	○	○
	R Link Register	○	○	○	○	○	■	○	○	○	○	○	○	○	○	○	○	○	○	○	○	■	○	○	○	○	○	○	○
	S Special Register	○	○	○	○	○	■	○	○	○	○	○	○	○	○	○	○	○	○	○	○	■	○	○	○	○	○	○	○
	N Current Value Register	○	○	○	○	○	■	○	○	○	○	○	○	○	○	○	○	○	○	○	○	■	○	○	○	○	○	○	○
	B File Register	○	○	○	○	○	■	○	○	○	○	○	○	○	○	○	○	○	○	○	○	■	○	○	○	○	○	○	○
	EX Extended Input	○	○	○	○	○	■	○	○	○	○	○	○	○	○	○	○	○	○	○	○	■	○	○	○	○	○	○	○
	EY Extended Output	○	○	○	○	○	■	○	○	○	○	○	○	○	○	○	○	○	○	○	○	■	○	○	○	○	○	○	○
	EM Extended Embedded Relay	○	○	○	○	○	■	○	○	○	○	○	○	○	○	○	○	○	○	○	○	■	○	○	○	○	○	○	○
	EK Extended Keep Relay	○	○	○	○	○	■	○	○	○	○	○	○	○	○	○	○	○	○	○	○	■	○	○	○	○	○	○	○
	EL Extended Link Relay	○	○	○	○	○	■	○	○	○	○	○	○	○	○	○	○	○	○	○	○	■	○	○	○	○	○	○	○
	EV Extended Special Relay	○	○	○	○	○	■	○	○	○	○	○	○	○	○	○	○	○	○	○	○	■	○	○	○	○	○	○	○
	EP Extended Edge Relay	■	■	■	■	■	■	■	■	■	■	■	■	■	■	■	■	■	■	■	■	■	■	■	■	■	■	■	■
	ET Extended Timer	○	○	○	○	○	■	○	○	○	○	○	○	○	○	○	○	○	○	○	○	■	○	○	○	○	○	○	○
	EC Extended Counter	○	○	○	○	○	■	○	○	○	○	○	○	○	○	○	○	○	○	○	○	■	○	○	○	○	○	○	○
	ES Extended Special Register	○	○	○	○	○	■	○	○	○	○	○	○	○	○	○	○	○	○	○	○	■	○	○	○	○	○	○	○
	EN Extended Current Value Register	○	○	○	○	○	■	○	○	○	○	○	○	○	○	○	○	○	○	○	○	■	○	○	○	○	○	○	○
	H Extended Current Value Register	○	○	○	○	○	■	○	○	○	○	○	○	○	○	○	○	○	○	○	○	■	○	○	○	○	○	○	○
	U Extended Data Register	○	○	○	○	○	■	○	○	○	○	○	○	○	○	○	○	○	○	○	○	■	○	○	○	○	○	○	○
	LS System Area	○	○	○	○	○	■	○	○	○	○	○	○	○	○	○	○	○	○	○	○	■	○	○	○	○	○	○	○

■ Toshiba PROSEC EX(2000)

		After Conversion							
		X	Y	R	Z	T	C	D	LS
Before Conversion	X External Input	○	○	○	○	◆	◆	○	○
	Y External Output	○	○	○	○	◆	◆	○	○
	R Auxiliary Relay	○	○	○	○	◆	◆	○	○
	Z Link Relay	○	○	○	○	◆	◆	○	○
	T Timer	◆	◆	◆	◆	○	○	◆	◆
	C Counter	◆	◆	◆	◆	○	○	◆	◆
	D Data Register	○	○	○	○	◆	◆	○	○
	LS System Area	○	○	○	○	◆	◆	○	○

■ Toshiba PROSEC T

		After Conversion											
		X	Y	R	S	Z	L	T	C	D	W	F	LS
Before Conversion	X External Input	○	○	○	○	■	■	◆	◆	○	○	○	○
	Y External Output	○	○	○	○	■	■	◆	◆	○	○	○	○
	R Internal Relay	○	○	○	○	■	■	◆	◆	○	○	○	○
	S Special Relay	○	○	○	○	■	■	◆	◆	○	○	○	○
	Z Link Register Relay	■	■	■	■	■	■	■	■	■	■	■	■
	L Link Relay	■	■	■	■	■	■	■	■	■	■	■	■
	T Timer	◆	◆	◆	◆	■	■	○	○	◆	◆	◆	◆
	C Counter	◆	◆	◆	◆	■	■	○	○	◆	◆	◆	◆
	D Data Register	○	○	○	○	■	■	◆	◆	○	○	○	○
	W Link Register	○	○	○	○	■	■	◆	◆	○	○	○	○
	F File Register	○	○	○	○	■	■	◆	◆	○	○	○	○
	LS System area	○	○	○	○	■	■	◆	◆	○	○	○	○

■ Toshiba PROSEC T (Ethernet)

		After Conversion												
		X	Y	R	S	Z	L	LW	T	C	D	W	F	LS
Before Conversion	X External Input	○	○	○	○	■	■	○	◆	◆	○	○	○	○
	Y External Output	○	○	○	○	■	■	○	◆	◆	○	○	○	○
	R Internal Relay	○	○	○	○	■	■	○	◆	◆	○	○	○	○
	S Special Relay	○	○	○	○	■	■	○	◆	◆	○	○	○	○
	Z Link Register Relay	'	'	'	'	■	■	■	■	■	■	■	■	■
	L Link Relay	'	'	'	'	■	■	■	■	■	■	■	■	■
	LW Link Relay	○	○	○	○	■	■	○	◆	◆	○	○	○	○
	T Timer	◆	◆	◆	◆	■	■	◆	○	○	◆	◆	◆	◆
	C Counter	◆	◆	◆	◆	■	■	◆	○	○	◆	◆	◆	◆
	D Data Register	○	○	○	○	■	■	○	◆	◆	○	○	○	○
	W Link Register	○	○	○	○	■	■	○	◆	◆	○	○	○	○
	F File Register	○	○	○	○	■	■	○	◆	◆	○	○	○	○
	LS System area	○	○	○	○	■	■	○	◆	◆	○	○	○	○

■ **Toshiba PROVISOR B** (same as Toshiba Machine PROVISOR TC200)

		After Conversion											
		X	Y	R/G/H	A	L	S	E	T	C	P/V	D/B	LS
Before Conversion	X Input Relay	○	○	○	○	○	○	○	○	○	○	○	○
	Y Output Relay	○	○	○	○	○	○	○	○	○	○	○	○
	R/G/H Internal Relay	○	○	○	○	○	○	○	○	○	○	○	○
	A Special auxiliary Relay	○	○	○	○	○	○	○	○	○	○	○	○
	L Latch Relay	○	○	○	○	○	○	○	○	○	○	○	○
	S Shift Register	○	○	○	○	○	○	○	○	○	○	○	○
	E Edge Relay	○	○	○	○	○	○	○	○	○	○	○	○
	T Timer (contact)	○	○	○	○	○	○	○	○	○	○	○	○
	C Counter (contact)	○	○	○	○	○	○	○	○	○	○	○	○
	P/V Timer/counter (current/setup)	○	○	○	○	○	○	○	○	○	○	○	○
	D/B Generic Register	○	○	○	○	○	○	○	○	○	○	○	○
	LS System Area	○	○	○	○	○	○	○	○	○	○	○	○

Timers and Counters use words and bits for contacts, current values, and setup values. Conversion is performed only on the word or bit of the corresponding value. For example, when converting the current value, conversion takes place only on the current value bit and does not affect the contact or setup.

■ Toshiba TC200 Series

		After Conversion																						
		X	I	Y	O	R	G	H	J	K	A	L	S	E	T	C	P	V	D	B	U	M	Q	LS
Before Conversion	X Input Relay 1	○	○	○	○	○	○	○	○	○	○	○	○	○	○	○	○	○	○	○	○	○	○	○
	I Input Relay 2	○	○	○	○	○	○	○	○	○	○	○	○	○	○	○	○	○	○	○	○	○	○	○
	Y Output Relay 1	○	○	○	○	○	○	○	○	○	○	○	○	○	○	○	○	○	○	○	○	○	○	○
	O Output Relay 2	○	○	○	○	○	○	○	○	○	○	○	○	○	○	○	○	○	○	○	○	○	○	○
	R Internal Relay	○	○	○	○	○	○	○	○	○	○	○	○	○	○	○	○	○	○	○	○	○	○	○
	G Extended Internal Relay 1	○	○	○	○	○	○	○	○	○	○	○	○	○	○	○	○	○	○	○	○	○	○	○
	H Extended Internal Relay 2	○	○	○	○	○	○	○	○	○	○	○	○	○	○	○	○	○	○	○	○	○	○	○
	J Extended Internal Relay 3	○	○	○	○	○	○	○	○	○	○	○	○	○	○	○	○	○	○	○	○	○	○	○
	K Extended Internal Relay 4	○	○	○	○	○	○	○	○	○	○	○	○	○	○	○	○	○	○	○	○	○	○	○
	A Special Auxiliary Relay 4	○	○	○	○	○	○	○	○	○	○	○	○	○	○	○	○	○	○	○	○	○	○	○
	L Latch Relay	○	○	○	○	○	○	○	○	○	○	○	○	○	○	○	○	○	○	○	○	○	○	○
	S Shift Register	○	○	○	○	○	○	○	○	○	○	○	○	○	○	○	○	○	○	○	○	○	○	○
	E Edge Relay	○	○	○	○	○	○	○	○	○	○	○	○	○	○	○	○	○	○	○	○	○	○	○
	T Timer (Contact)	○	○	○	○	○	○	○	○	○	○	○	○	○	○	○	○	○	○	○	○	○	○	○
	C Counter (Contact)	○	○	○	○	○	○	○	○	○	○	○	○	○	○	○	○	○	○	○	○	○	○	○
	P Timer/Counter (current value)	○	○	○	○	○	○	○	○	○	○	○	○	○	○	○	○	○	○	○	○	○	○	○
	V Timer/Counter (setup value)	○	○	○	○	○	○	○	○	○	○	○	○	○	○	○	○	○	○	○	○	○	○	○
	D Generic Register 1	○	○	○	○	○	○	○	○	○	○	○	○	○	○	○	○	○	○	○	○	○	○	○
	B Generic Register 2	○	○	○	○	○	○	○	○	○	○	○	○	○	○	○	○	○	○	○	○	○	○	○
	U Generic Register 3	○	○	○	○	○	○	○	○	○	○	○	○	○	○	○	○	○	○	○	○	○	○	○
M Generic Register 4	○	○	○	○	○	○	○	○	○	○	○	○	○	○	○	○	○	○	○	○	○	○	○	
Q Generic Register 5	○	○	○	○	○	○	○	○	○	○	○	○	○	○	○	○	○	○	○	○	○	○	○	
LS System area	○	○	○	○	○	○	○	○	○	○	○	○	○	○	○	○	○	○	○	○	○	○	○	

■ Koyo Electronic KOSTAC SG/SU/SZ

		After Conversion									
		I	Q	M	S	GI	SP	T	C	R	LS
Before Conversion	I Input Relay	○	○	○	○	○	○	◆	◆	○	○
	Q Output Relay	○	○	○	○	○	○	◆	◆	○	○
	M Control Relay	○	○	○	○	○	○	◆	◆	○	○
	S Stage	○	○	○	○	○	○	◆	◆	○	○
	GI Link Relay	○	○	○	○	○	○	◆	◆	○	○
	SP Specified Relay	○	○	○	○	○	○	◆	◆	○	○
	T Timer	◆	◆	◆	◆	◆	◆	○	○	◆	◆
	C Counter	◆	◆	◆	◆	◆	◆	○	○	◆	◆
	R Variable Memory/ Data Register	○	○	○	○	○	○	◆	◆	○	○
	LS System Area	○	○	○	○	○	○	◆	◆	○	○

■ Koyo Electronic KOSTAC SR

		After Conversion						
		(1)	(2)	(3)	(4)	(5)	(6)	(7)
Before Conversion	(1) Input/Ouput	○	○	○	○	★	○	○
	(2) Control Relay	○	○	○	○	★	○	○
	(3) Shift Register	○	○	○	○	★	○	○
	(4) Timer/Counter (contact)	○	○	○	○	★	○	○
	(5) Timer/Counter (elapsed value)	★	★	★	★	★	★	★
	(6) Data Register	○	○	○	○	★	○	○
	(7) System Area	○	○	○	○	★	○	○

■ Koyo Electronic DL-205/405

		After Conversion									
		X	Y	C	S	GX	GY	T	CT	V	LS
Before Conversion	X Input Relay	○	○	○	○	○	○	◆	◆	○	○
	Y Output Relay	○	○	○	○	○	○	◆	◆	○	○
	C Control Relay	○	○	○	○	○	○	◆	◆	○	○
	S Stage	○	○	○	○	○	○	◆	◆	○	○
	GX Link Relay	○	○	○	○	○	○	◆	◆	○	○
	GY Specified Relay	○	○	○	○	○	○	◆	◆	○	○
	T Timer	◆	◆	◆	◆	◆	◆	○	○	◆	◆
	CT Counter	◆	◆	◆	◆	◆	◆	○	○	◆	◆
	V Variable Memory/ Data Register	○	○	○	○	○	○	◆	◆	○	○
	LS System Area	○	○	○	○	○	○	◆	◆	○	○

■ Koyo Electronic DL-305

		After Conversion						
		(1)	(2)	(3)	(4)	(5)	(6)	(7)
Before Conversion	(1) Input/Output	○	○	○	○	★	○	○
	(2) Control Relay	○	○	○	○	★	○	○
	(3) Shift Register	○	○	○	○	★	○	○
	(4) Timer/Counter (contact)	○	○	○	○	★	○	○
	(5) Timer/Counter (elapsed value)	★	★	★	★	★	★	★
	(6) Data Register	○	○	○	○	★	○	○
	(7) System Area	○	○	○	○	★	○	○

■ Automation GE FANUC Series 90-70/90-30

		After Conversion												
		I	Q	M	G	T	SA	SB	SC	S	R	AI	AQ	LS
Before Conversion	I Input Relay	○	○	○	○	○	○	○	○	○	○	○	○	○
	Q Output Relay	○	○	○	○	○	○	○	○	○	○	○	○	○
	M Control Relay	○	○	○	○	○	○	○	○	○	○	○	○	○
	G Global Relay	○	○	○	○	○	○	○	○	○	○	○	○	○
	T Timer Relay	○	○	○	○	○	○	○	○	○	○	○	○	○
	SA System Relay	○	○	○	○	○	○	○	○	○	○	○	○	○
	SB System Relay	○	○	○	○	○	○	○	○	○	○	○	○	○
	SC System Relay	○	○	○	○	○	○	○	○	○	○	○	○	○
	S System Relay	○	○	○	○	○	○	○	○	○	○	○	○	○
	R Register	○	○	○	○	○	○	○	○	○	○	○	○	○
	AI Analog Input	○	○	○	○	○	○	○	○	○	○	○	○	○
	AQ Analog Output	○	○	○	○	○	○	○	○	○	○	○	○	○
	LS System Area	○	○	○	○	○	○	○	○	○	○	○	○	○

■ GE Fanuc 90-30/90-70 SNP

		After Conversion												
		I	Q	M	G	T	SA	SB	SC	S	R	AI	AQ	LS
Before Conversion	Input Relay (I)	○	○	○	○	○	○	○	○	○	○	○	○	○
	Output Relay (Q)	○	○	○	○	○	○	○	○	○	○	○	○	○
	Internal Relay (M)	○	○	○	○	○	○	○	○	○	○	○	○	○
	Global Relay (G)	○	○	○	○	○	○	○	○	○	○	○	○	○
	Temporary Relay (T)	○	○	○	○	○	○	○	○	○	○	○	○	○
	System Status Relay	○	○	○	○	○	○	○	○	○	○	○	○	○
	System Status Relay	○	○	○	○	○	○	○	○	○	○	○	○	○
	System Status Relay	○	○	○	○	○	○	○	○	○	○	○	○	○
	System Status Relay	○	○	○	○	○	○	○	○	○	○	○	○	○
	Register (R)	○	○	○	○	○	○	○	○	○	○	○	○	○
	Analog Input (AI)	○	○	○	○	○	○	○	○	○	○	○	○	○
	Analog Output (AQ)	○	○	○	○	○	○	○	○	○	○	○	○	○
	LS Area (LS)	○	○	○	○	○	○	○	○	○	○	○	○	○

■ Fanuc FANUC Power Mate

		After Conversion							
		X	Y	R	K	T	C	D	LS
Before Conversion	X Input Relay	○	○	○	○	★	★	○	○
	Y Output Relay	○	○	○	○	★	★	○	○
	R Control Relay	○	○	○	○	★	★	○	○
	K Keep Relay	○	○	○	○	★	★	○	○
	T Timer	★	★	★	★	★	★	★	★
	C Counter	○	○	○	○	★	★	○	○
	D Data Table	○	○	○	○	★	★	○	○
	LS System Area	○	○	○	○	★	★	○	○

■ IDEC Izumi FA-2/2J/3S

		After Conversion								
		X	Y	M	R	T/TS	H	C/CS	D	LS
Before Conversion	X Input Relay	○	○	○	○	◆	◆	◆	○	○
	Y Output Relay	○	○	○	○	◆	◆	◆	○	○
	M Internal Relay	○	○	○	○	◆	◆	◆	○	○
	R Shift Register	○	○	○	○	◆	◆	◆	○	○
	T/TS Timer	◆	◆	◆	◆	◆	◆	◆	◆	◆
	H Timer (10 ms)	◆	◆	◆	◆	◆	◆	◆	◆	◆
	C/CS Counter	◆	◆	◆	◆	◆	◆	◆	◆	◆
	D Data Register	○	○	○	○	◆	◆	◆	○	○
	LS System Area	○	○	○	○	◆	◆	◆	○	○

■ IDEC Izumi MICRO³

		After Conversion							
		X	Y	M	R	T/t	C/c	D	LS
Before Conversion	X Input Relay	○	○	○	○	◆	◆	○	○
	Y Output Relay	○	○	○	○	◆	◆	○	○
	M Internal Relay	○	○	○	○	◆	◆	○	○
	R Shift Register	○	○	○	○	◆	◆	○	○
	T/t Timer	◆	◆	◆	◆	◆	◆	◆	◆
	C/c Counter	◆	◆	◆	◆	◆	◆	◆	◆
	D Data Register	○	○	○	○	◆	◆	○	○
	LS System Area	○	○	○	○	◆	◆	○	○

■ Siemens Simatic S5

		After Conversion							
		I	O	F	T	C	D	X	LS
Before Conversion	I Input Relay	○	○	○	★	★	○	○	○
	O Output Relay	○	○	○	★	★	○	○	○
	F Control Relay	○	○	○	★	★	○	○	○
	T Timer	★	★	★	★	★	★	★	★
	C Counter	★	★	★	★	★	★	★	★
	D Data Register	○	○	○	★	★	○	○	○
	X Expanded	○	○	○	★	★	○	○	○
	LS System Area	○	○	○	★	★	○	○	○

There is no X (Extended Data Register) for S5 90U, 95U, 100U, 115U CPU Direct Connections.

■ Siemens S7-200 (PPI)

		After Conversion							
		E	A	M	SM	T	C	VW	LS
Before Conversion	I Input	○	○	○	○	◆	◆	○	○
	Q Output	○	○	○	○	◆	◆	○	○
	M Internal Memory	○	○	○	○	◆	◆	○	○
	SM Special Memory	○	○	○	○	◆	◆	○	○
	T Timer	◆	◆	◆	◆	◆	◆	◆	◆
	C Counter	◆	◆	◆	◆	◆	◆	◆	◆
	VW Variable Bit	○	○	○	○	◆	◆	○	○
	LS System Area	○	○	○	○	◆	◆	○	○

■ Siemens S7-300/400 (MPI port)

		After Conversion						
		E	A	M	T	C	DB	LS
Before Conversion	E Input	○	○	○	◆	◆	○	○
	A Output	○	○	○	◆	◆	○	○
	M Internal Bit	○	○	○	◆	◆	○	○
	T Timer Word	◆	◆	◆	◆	◆	◆	◆
	C Counter Word	◆	◆	◆	◆	◆	◆	◆
	DB Data Block	○	○	○	◆	◆	○	○
	LS System Area	○	○	○	◆	◆	○	○

■ Siemens S7-300/400 (3964/RK512 protocol)

		After Conversion	
		D	LS
Before Conversion	D Data Memory	○	○
	LS System Area	○	○

■ Siemens SIMATIC 505 Series

		After Conversion					
		V	X	Y	CR	All PLC Devices except for V/X/Y/CR	LS
Before Conversion	V Variable Memory	○	■	■	■	★	○
	X Discrete Input accessed as bit	■	■	■	■		■
	Y Discrete Output accessed as bit	■	■	■	■		■
	CR	■	■	■	■	★	■
	All PLC Devices except for V/X/Y/CR	★				★	★
	LS System Area	○	■	■	■	★	○

■ Siemens S7-MPI

		After Conversion						
		E	A	M	T	C	DB	LS
Before Conversion	E Input	○	○	○	◆	◆	○	○
	A Output	○	○	○	◆	◆	○	○
	M Internal Bit	○	○	○	◆	◆	○	○
	T Timer Word	◆	◆	◆	◆	◆	◆	◆
	C Counter Word	◆	◆	◆	◆	◆	◆	◆
	DB Data Block	○	○	○	◆	◆	○	○
	LS System Area	○	○	○	◆	◆	○	○

■ Siemens S7-300 (Profibus DP)

		After Conversion				
		M	I	O	D	DB2W-DB60W
Before Conversion	M	○	○	○	○	○
	I	○	○	○	○	○
	O	○	○	○	○	○
	D	○	○	○	○	○
	DB2W-DB60W	○	○	○	○	○

■ Rockwell (Allen Bradley) SLC 500

		After Conversion						
		B	TT/TN	CU/CD/CN	TP/TA	CP/CA	N	LS
Before Conversion	B Bit	○	■	■	★	★	○	○
	TT/TN Timer (contact)	■	■	■			■	■
	CU/CD/CN Counter (contact)	■	■	■			■	■
	TP/TA Timer (setup/current)	★			★	★	★	★
	CP/CA Counter (setup/current)	★			★	★	★	★
	N Integer	○	■	■	★	★	○	○
	LS System Area	○	■	■	★	★	○	○

■ Rockwell (Allen Bradley) PLC-5

		After Conversion								
		I	O	B	TT/TD	CC/CD	TA/TP	CA/CP	N/D/A	LS
Before Conversion	I Input Relay	○	○	○	■	■	★	★	○	○
	O Output Relay	○	○	○	■	■	★	★	○	○
	B Internal Relay	○	○	○	■	■	★	★	○	○
	TT/TD Timer (contact)	■	■	■	■	■			■	■
	CC/CD Counter (contact)	■	■	■	■	■			■	■
	TA/TP Timer	★	★	★			★	★	★	★
	CA/CP Counter	★	★	★			★	★	★	★
	N/D/A Data Register	○	○	○	■	■	★	★	○	○
	LS System Area	○	○	○	■	■	★	★	○	○

■ Rockwell (Allen Bradley) (Remote I/O)

		After Conversion				
		I	O	BTR	BTW	LS
Before Conversion	I Input	○	○	○	○	○
	O Output	○	○	○	○	○
	BTR Block Transfer(Read)	○	○	○	○	○
	BTW Block Transfer(Write)	○	○	○	○	○
	LS System Area	○	○	○	○	○

■ Allen Bradley SLC 500 <Data Highway>

		After Conversion											
		0	1	S	B	T	C	R	N	F	A	ST	LS
Before Conversion	0	■	■	■	■				■				■
	1	■	■	■	■				■				■
	S	■	■	○	○				○		★		
	B	■	■	○	○				○		★		○
	T					◆							○
	C						◆						
	R							◆					
	N	■	■	○	○				○		★		○
	F									★			
	A			★	★				★		★		★
	ST											★	
	LS	■	■	○	○				○		★		○

■ Interbus-S

		After Conversion	
		0000 to 02EE	LS
Before Conversion	0000 to 02EE	○	○
	LS	○	○

■ Keyence KZ-300, KZ-500 (Direct Connection)

		After Conversion					
		Relay	T	C	DM	TM	LS
Before Conversion	Relay	○	◆	◆	○	○	○
	T Timer	◆	◆	◆	◆	◆	◆
	C Counter	◆	◆	◆	◆	◆	◆
	DM Data memory	○	◆	◆	○	○	○
	TM Temporary data memory	○	◆	◆	○	○	○
	LS System area	○	◆	◆	○	○	○

■ Keyence KZ - A500 (Link I/F)

		After Conversion													
		-	T	C	CTC	TC	CC	TS	CS	DM	TM	AT	CTH	CTC	LS
Before Conversion	Relay	○	■	■	■	★	★	★	★	○	○	★	★	★	○
	T Timer (contact)	■	■	■	■					■	■				■
	C Counter (contact)	■	■	■	■					■	■				■
	CTC High-speed Counter Comparator (contact)	■	■	■	■					■	■				■
	TC Timer (setup value)	★				★	★	★	★	★	★	★	★	★	★
	CC Counter (setup value)	★				★	★	★	★	★	★	★	★	★	★
	TS Timer (current value)	★				★	★	★	★	★	★	★	★	★	★
	CS Counter (current value)	★				★	★	★	★	★	★	★	★	★	★
	DM Data Memory	○	■	■	■	★	★	★	★	○	○	★	★	★	○
	TM Temporary Data Memory	○	■	■	■	★	★	★	★	○	○	★	★	★	○
	AT Digital Trimmer	★				★	★	★	★	★	★	★	★	★	★
	CTH High-speed Counter (current value)	★				★	★	★	★	★	★	★	★	★	★
	CTC High-speed Counter Comparator (setup value)	★				★	★	★	★	★	★	★	★	★	★
	LS LS Area	○	■	■	■	★	★	★	★	○	○	★	★	★	○

■ Keyence KV Series

		After Conversion													
		-	T	C	CTC	TC	CC	TS	CS	DM	TM	AT	CTH	CTC	LS
Before Conversion	Relay	○	■	■	■	★	★	★	★	○	○	★	★	★	○
	T Timer (contact)	■	■	■	■					■	■				■
	C Counter (contact)	■	■	■	■					■	■				■
	CTC High-speed Counter Comparator (contact)	■	■	■	■					■	■				■
	TC Timer (setup value)	★				★	★	★	★	★	★	★	★	★	★
	CC Counter (setup value)	★				★	★	★	★	★	★	★	★	★	★
	TS Timer (current value)	★				★	★	★	★	★	★	★	★	★	★
	CS Counter (current value)	★				★	★	★	★	★	★	★	★	★	★
	DM Data Memory	○	■	■	■	★	★	★	★	○	○	★	★	★	○
	TM Temporary Data Memory	○	■	■	■	★	★	★	★	○	○	★	★	★	○
	AT Digital Trimmer	★				★	★	★	★	★	★	★	★	★	★
	CTH High-speed Counter (current value)	★				★	★	★	★	★	★	★	★	★	★
	CTC High-speed Counter Comparator (setup value)	★				★	★	★	★	★	★	★	★	★	★
	LS LS Area	○	■	■	■	★	★	★	★	○	○	★	★	★	○

■ Shinkoh Technos SELMART

		After Conversion	
		D	LS
Before Conversion	D Data Register	○	○
	LS System Area	○	○

■ Matsushita Electric Industrial Panadac 7000

		After Conversion																		
		IN	OT	RL	KR	LK	ST	MS	TS	TU	CU	CI	CO	M	LM	TM	CT	TC	PM	LS
Before Conversion	IN I/O Relay	○	○	○	○	○	○	○	○	○	○	○	○	○	○	○	○	○	○	○
	OT I/O Relay	○	○	○	○	○	○	○	○	○	○	○	○	○	○	○	○	○	○	○
	RL Internal Relay	○	○	○	○	○	○	○	○	○	○	○	○	○	○	○	○	○	○	○
	KR Hold Relay	○	○	○	○	○	○	○	○	○	○	○	○	○	○	○	○	○	○	○
	LK Link Relay	○	○	○	○	○	○	○	○	○	○	○	○	○	○	○	○	○	○	○
	ST Status Relay	○	○	○	○	○	○	○	○	○	○	○	○	○	○	○	○	○	○	○
	MS MC Status Relay	○	○	○	○	○	○	○	○	○	○	○	○	○	○	○	○	○	○	○
	TS Timer State Relay	○	○	○	○	○	○	○	○	○	○	○	○	○	○	○	○	○	○	○
	TU Timer Up Relay	○	○	○	○	○	○	○	○	○	○	○	○	○	○	○	○	○	○	○
	CU Count Up Relay	○	○	○	○	○	○	○	○	○	○	○	○	○	○	○	○	○	○	○
	CI CPU Input Relay	○	○	○	○	○	○	○	○	○	○	○	○	○	○	○	○	○	○	○
	CO CPU Output Relay	○	○	○	○	○	○	○	○	○	○	○	○	○	○	○	○	○	○	○
	M Data Memory	○	○	○	○	○	○	○	○	○	○	○	○	○	○	○	○	○	○	○
	LM Link Register	○	○	○	○	○	○	○	○	○	○	○	○	○	○	○	○	○	○	○
	TM Timer (current)	○	○	○	○	○	○	○	○	○	○	○	○	○	○	○	○	○	○	○
	CT Timer (current)	○	○	○	○	○	○	○	○	○	○	○	○	○	○	○	○	○	○	○
	TC Counter Value	○	○	○	○	○	○	○	○	○	○	○	○	○	○	○	○	○	○	○
PM Position Data	○	○	○	○	○	○	○	○	○	○	○	○	○	○	○	○	○	○	○	
LS System Area	○	○	○	○	○	○	○	○	○	○	○	○	○	○	○	○	○	○	○	

■ Matsushita Electric Industrial MINAS-A/S Series

		After Conversion	
		All Devices	LS
Before Conversion	All Devices	○	○
	LS System Area	○	○

■ Orim Vexta E1 Series

		After Conversion																	
		I	IU	ID	O	AD	DA	M	SL	SH	SR	SD	R	RD	B	MP	MS	SY	LS
Before Conversion	I Input Relay	○	○	○	○	○	○	○	○	○	○	○	○	○	○	○	○	○	○
	IU ON Event Input Register	○	○	○	○	○	○	○	○	○	○	○	○	○	○	○	○	○	○
	ID OFF Event Input Register	○	○	○	○	○	○	○	○	○	○	○	○	○	○	○	○	○	○
	O Output Register	○	○	○	○	○	○	○	○	○	○	○	○	○	○	○	○	○	○
	AD Analog Input Register	○	○	○	○	○	○	○	○	○	○	○	○	○	○	○	○	○	○
	DA Analog Output Register	○	○	○	○	○	○	○	○	○	○	○	○	○	○	○	○	○	○
	M Position Register	○	○	○	○	○	○	○	○	○	○	○	○	○	○	○	○	○	○
	SL Speed Register - Low	○	○	○	○	○	○	○	○	○	○	○	○	○	○	○	○	○	○
	SH Speed Register - High	○	○	○	○	○	○	○	○	○	○	○	○	○	○	○	○	○	○
	SR Speed Register -Increase	○	○	○	○	○	○	○	○	○	○	○	○	○	○	○	○	○	○
	SD Speed Register - Reduce	○	○	○	○	○	○	○	○	○	○	○	○	○	○	○	○	○	○
	R Common Register	○	○	○	○	○	○	○	○	○	○	○	○	○	○	○	○	○	○
	RD Common Expanded Register	○	○	○	○	○	○	○	○	○	○	○	○	○	○	○	○	○	○
	B Base Register	○	○	○	○	○	○	○	○	○	○	○	○	○	○	○	○	○	○
	MP Current Motor Position	○	○	○	○	○	○	○	○	○	○	○	○	○	○	○	○	○	○
	MS Current Motor Status	○	○	○	○	○	○	○	○	○	○	○	○	○	○	○	○	○	○
	SY SY Register	○	○	○	○	○	○	○	○	○	○	○	○	○	○	○	○	○	○
LS System Area	○	○	○	○	○	○	○	○	○	○	○	○	○	○	○	○	○	○	

■ Yamatake Yamatake SDC Series/DMC10

		After Conversion	
		Data	LS
Before Conversion	Data	○	○
	LS System Area	○	○

■ Rika Kohgyou CB/SR-Mini Series

		After Conversion	
		0000 to 02EE	LS
Before Conversion	0000 to 02EE	○	○
	LS	○	○

■ Shinkoh Technos C/FC/FIR/GC/FCL/PC-900 Series

		After Conversion			
		—	S	C	LS
Before Conversion	-----	○	○	○	○
	Setting Value Memory	○	○	○	○
	Channel	○	○	○	○
	LS Area LS	○	○	○	○

■ Facom FB 20MC

		After Conversion																					
		1	2	3	4	5	6	7	8	9	10	11	12	13	14	15	16	17	18	19	20	21	22
Before Conversion	(1) X	■	■	■	■	■	■	■								■	■	■	■	■	■	■	■
	(2) Y	■	■	■	■	■	■	■								■	■	■	■	■	■	■	■
	(3) M	■	■	■	■	■	■	■								■	■	■	■	■	■	■	■
	(4) SM	■	■	■	■	■	■	■								■	■	■	■	■	■	■	■
	(5) S	■	■	■	■	■	■	■								■	■	■	■	■	■	■	■
	(6) T	■	■	■	■	■	■	■								■	■	■	■	■	■	■	■
	(7) C	■	■	■	■	■	■	■								■	■	■	■	■	■	■	■
	(8) WX								★	★	★	★	★	★	★	★	★	★	★	★	★	★	★
	(9) WY								★	★	★	★	★	★	★	★	★	★	★	★	★	★	★
	(10) WM								★	★	★	★	★	★	★	★	★	★	★	★	★	★	★
	(11) WSM								★	★	★	★	★	★	★	★	★	★	★	★	★	★	★
	(12) WS								★	★	★	★	★	★	★	★	★	★	★	★	★	★	★
	(13) TMR								★	★	★	★	★	★	★	★	★	★	★	★	★	★	★
	(14) CTR								★	★	★	★	★	★	★	★	★	★	★	★	★	★	★
	(15) HR	■	■	■	■	■	■	■	★	★	★	★	★	★	★	★	○	○	○	○	○	○	○
	(16) IR	■	■	■	■	■	■	■	★	★	★	★	★	★	★	★	○	○	○	○	○	○	○
	(17) OR	■	■	■	■	■	■	■	★	★	★	★	★	★	★	★	○	○	○	○	○	○	○
	(18) HSC	■	■	■	■	■	■	■	★	★	★	★	★	★	★	★	○	○	○	○	○	○	○
	(19) RTC	■	■	■	■	■	■	■	★	★	★	★	★	★	★	★	○	○	○	○	○	○	○
	(20) SR	■	■	■	■	■	■	■	★	★	★	★	★	★	★	★	○	○	○	○	○	○	○
	(21) ROR	■	■	■	■	■	■	■	★	★	★	★	★	★	★	★	○	○	○	○	○	○	○
	(22) LS	■	■	■	■	■	■	■	★	★	★	★	★	★	★	★	○	○	○	○	○	○	○

■ RKC CB/SR-Mini

		After Conversion	
Before Conversion		0000 to 02EE	LS
	0000 to 02EE	○	○
	LS	○	○

A.4 Software Trouble Report

■ When problems continue after following “Troubleshooting” advice

If following the steps outlined in the troubleshooting section does not solve your problem, please make a copy of the next page’s Software Trouble Report, fill in any relevant information, and fax it to your local Pro-face service center.

Please include any relevant details, including project data and/or screens so that the problem can be duplicated. We guarantee all this data will remain confidential.

Also, please take the time to use the “OSCHECK” tool installed with your GP-PRO/PBIII software, and include a printout of its result with your fax.

Using the “OSCHECK” Program

This program, after it completes its test, produces a text file (*.txt). Please be sure to print out this data and include it with your Software Trouble Report.

- 1) Click on the Windows main screen’s [Start] button and then on the [Run] selection.
- 2) Here, use the [Browse] feature to find the OSCHECK.EXE program, located in your PC’s “ProPBWin” folder. Once you find it, click on to start the program.
- 3) Designate the status report’s Save folder and filename.
- 4) Click again on and the text file will be created.



- ***When inquiring, be sure to write down your software’s serial No. Without your software’s serial No., your question(s) cannot be answered.***
- ***Understand that it may take some time for us to respond, since your question must be carefully checked and recreated.***

Pro-face FAX and Email Information:

- **Pro-face Europe:** FAX No. +31-(0)20-6464-358 Email: support@proface.com
- **Pro-Face Korea:** FAX No. +82-(0)2-3664-6839 Email: proface@proface.co.kr
- **Pro-Face Taiwan:** FAX No. +886-(0)2-8773-7892 Email: proface@proface.com.tw
- **Pro-face America / Xycom (North and South):** FAX No. +1-734-429-1010
Email: support@profaceamerica.com

Digital (Japan) FAX and Email Information:

- Digital Electronics Corporation: FAX No. +81-(0)6-6613-5982 Email: support@digital.co.jp
- Also, if you require instruction about the correct usage of your GP-PRO/PBIII for Windows software, please use the above information to contact your local GP-PRO/PBIII distributor.

<h2 style="margin: 0;">Software Trouble Report</h2>	Date: _____ Number of pages: _____				
Company name _____ Department _____ TEL _____ Your name _____ FAX _____ Company Address _____					
Software Serial No. <input type="text"/> <input type="text"/> <input type="text"/> <input type="text"/> <input type="text"/> <input type="text"/> <input type="text"/> <input type="text"/>					
* We cannot respond to any questions without your software's serial number.					
Software name : GP-PRO/PB III for Windows () GP-PRO/PBIII Other Ver._____ C-Package01 ()					
Your GP model: _____ Device/PLC type: _____					
PC: Manufacturer: _____ Model: _____					
Printer Manufacturer: () Model: () Driver version: ()					
Describe the details and how to reproduce each problem. Also, please include a list of any related documents. Prepare one report sheet for each problem.					
----- Error message details:					
(This area is for Pro-face use only)	<table border="1" style="width: 100%; border-collapse: collapse;"> <tr> <td style="width: 50%; padding: 2px;">Processed by</td> <td style="width: 50%; padding: 2px;">Received by</td> </tr> <tr> <td style="height: 30px;"></td> <td style="height: 30px;"></td> </tr> </table>	Processed by	Received by		
Processed by	Received by				

Memo